



RUS 2011-2012





Содержание

RUS 1– 24

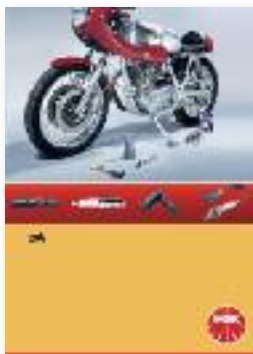













Свечи зажигания, свечи накаливания и наконечники, приведенные в каталоге, могут быть установлены на конкретные двигатели в соответствии с рекомендациями в каталоге.

Видимые ошибки и очевидные опiski подлежат проверки со стороны пользователей.

Отсутствие брака и правильность параметров продукции компания NGK гарантирует в соответствии с развитием техники. Гарантия действует только при надлежащей эксплуатации продукции компании NGK. Гарантия на отсутствие заводского брака и на качество используемых материалов действует 24 месяца с момента покупки товара, если иное не предписано производителем автомобиля. Исключение составляет нормальный износ а также использования продукции в гоночных двигателях. Автомобили производителей АвтоВАЗ обозначены VAZ, ГАЗ обозначены GAZ, УАЗ UAZ и Москвич MOSKWICZ. Не используйте для подбора свечей зажигания/накаливания обозначения LADA, VOLGA. Эти обозначения действуют для немецкого рынка.

Примечания:

1. Данный перечень спецификаций предназначен только для выбора типа свечей.
2. С опубликованием данного издания все предшествующие перечни спецификаций теряют силу.
3. Содержание списка не может послужить основой для возникновения правоприязания.
4. Рекомендации для авиационных двигателей согласно директивам FAA в данное издание не включены.

| | | |
|---|---|----------------|
| Оригинальные запчасти по всему миру |  | 2 |
| Моменты затяжки свечей зажигания |  | 3 |
| Моменты затяжки свечей накаливания |  | 3 |
| Маркировочные отметки свечей зажигания |  | 4 – 5 |
| Маркировочные отметки свечей накаливания |  | 6 – 7 |
| Сравнительный перечень свечей зажигания |  | 8 |
| V-Line |  | 9 – 13 |
| LPG LaserLine |  | 14 – 17 |
| D-Power |  | 18 |
| Керамические свечи накаливания |  | 19 |
| Обзор D-Power |  | 20 |
| Гоночные свечи зажигания |  | 21 – 23 |
| Размещение номеров двигателей |  | 24 |

| | |
|--|------------------|
| Серии свечей зажигания | 1 – 11 |
| Серии свечей накаливания | 12 – 32 |
| Свечи зажигания и накаливания для легковых автомобилей с 1990 | 33 – 252 |
| Сравнительный перечень | 253 – 357 |
| PS (HP) ↔ KW | 358 |

Крайний срок 01.03.2011

Возможны изменения
2011 – 2012





Свечи зажигания и накаливания фирмы NGK – производителя оригинальных запчастей по всему миру

| Производитель | Свечи зажигания | Свечи накаливания |
|----------------|-----------------|-------------------|
| Alfa Romeo | ● | ● |
| AMG | ● | |
| Aston Martin | ● | |
| Audi | ● | ● |
| Bentley | ● | |
| BMW | ● | |
| Bugatti | ● | |
| Chrysler | ● | |
| Citroën | ● | ● |
| Daewoo | ● | |
| Daihatsu | ● | ● |
| Ferrari | ● | |
| Fiat | ● | ● |
| Ford | ● | ● |
| General Motors | ● | |
| Honda | ● | ● |
| Hyundai | ● | ● |
| Isuzu | ● | ● |
| Jaguar | ● | |
| Kia | ● | ● |
| Lancia | ● | ● |
| Lamborghini | ● | |

| Производитель | Свечи зажигания | Свечи накаливания |
|---------------|-----------------|-------------------|
| Lotus | ● | |
| Maserati | ● | |
| Mazda | ● | ● |
| Mercedes | ● | ● |
| Mitsubishi | ● | ● |
| Nissan | ● | ● |
| Opel | ● | |
| Porsche | ● | |
| Peugeot | ● | ● |
| Renault | ● | |
| Landrover | ● | |
| Saab | ● | |
| Seat | ● | |
| Skoda | ● | ● |
| Smart | ● | ● |
| Subaru | ● | ● |
| Suzuki | ● | ● |
| Toyota | ● | ● |
| | ● | |
| Vauxhall | ● | |
| Volkswagen | ● | ● |
| Volvo | | ● |





Моменты затяжки свечей зажигания

Крутящие моменты

Для компетентного монтажа свечи зажигания требуется динамометрический ключ. Поскольку даже для специалистов почти невозможно оценить момент затяжки.

Это связано с тем, что крутящий момент состоит из двух величин, умножаемых друг на друга: силы, воздействующей на соответствующий центр вращения и длины рукоятки.

Большинство поломок свечей зажигания происходит из-за неправильного момента затяжки. Если он будет слишком низким, возникнут потери компрессии и перегрев. Из-за вибрации может также сломаться изолятор или средний электрод.

Если крутящий момент будет слишком высоким, свеча зажигания может оторваться. Также может расширяться или деформироваться корпус. Нарушаются зоны теплоотведения, что чревато перегревом и оплавлением электродов, вплоть до поломки двигателя.

| Материал головки цилиндра | Свеча зажигания с плоской посадкой (с уплотнением) | | | | Свеча зажигания с конической посадкой | |
|---------------------------|--|----------|----------|----------|---------------------------------------|----------|
| | Диаметр резьбы | | | | Диаметр резьбы | |
| | 18 мм | 14 мм | 12 мм | 10 мм | 18 мм | 14 мм |
| Чугунная головка | 35-45 Нм | 25-35 Нм | 15-25 Нм | 10-15 Нм | 20-30 Нм | 15-25 Нм |
| Алюминиевая головка | 35-40 Нм | 25-30 Нм | 15-20 Нм | 10-12 Нм | 20-30 Нм | 10-20 Нм |

Крутящие моменты зависят от материала головки цилиндра и диаметра резьбы

Моменты затяжки свечей накаливания

Правильный крутящий момент

Для надлежащего монтажа свечи накаливания рекомендуется использовать динамометрический ключ. Поскольку даже для специалистов почти невозможно оценить момент затяжки.

Это связано с тем, что крутящий момент состоит из двух величин, умножаемых друг на друга: силы, воздействующей на соответствующий центр вращения и длины рукоятки.

Если свеча накаливания устанавливается посредством неправильного крутящего момента, это может привести к потере компрессии. Из-за вибрации в керамических свечах накаливания может лопнуть керамика.

Применение слишком высокого момента затяжки может повлечь за собой сужение кольцевого зазора между металлическим корпусом и калильной трубкой. В этом случае свеча накаливания перегревается и выходит из строя.

| Момент затяжки свечей накаливания | |
|-----------------------------------|----------------|
| Диаметр резьбы | Момент затяжки |
| 8 мм | 8-15 Нм |
| 10 мм | 15-20 Нм |
| 12 мм | 20-25 Нм |
| 14 мм | 20-25 Нм |
| 18 мм | 20-30 Нм |

| Моменты затяжки контактных гаек | |
|---------------------------------|----------------|
| Диаметр резьбы | Момент затяжки |
| 4 мм (M4) | 0,8-1,5 Нм |
| 5 мм (M5) | 3,0-4,0 Нм |

Только при правильном крутящем моменте свечи накаливания действуют исправно

Маркировка свечей зажигания

Здесь приведена стандартная надпись типа. Кроме того, существуют некоторые специальные обозначения.

| Диаметр резьбы / Шестигранник | | Структура | | Помехоподавляющий резистор | | Калильное число | |
|-------------------------------|-----------------|-----------|--|----------------------------|--------------------------|-----------------|---|
| A | 18 мм / 25,4 мм | P | с выступающим изолятором | R | с резистором | 2 |  <p>горячие</p> <p>холодные</p> |
| B | 14 мм / 20,8 мм | M | Компактная свеча | Z | с индуктивным резистором | 4 | |
| C | 10 мм / 16,0 мм | U | Тип с поверхностным разрядом или дополнительным искровым зазором | | | 5 | |
| D | 12 мм / 18,0 мм | | | | | 6 | |
| E | 8 мм / 13,0 мм | | | | | 7 | |
| AB | 18 мм / 20,8 мм | | | | | 8 | |
| BC | 14 мм / 16,0 мм | | | | | 9 | |
| BK | 14 мм / 16,0 мм | | | | | 10 | |
| DC | 12 мм / 16,0 мм | | | | | | |

B P R 5 E S - 11

| Длина резьбы | | Конструктивные особенности | | Межэлектродный зазор | |
|--------------|--|----------------------------|---|----------------------|--|
| E | 19,0 мм | B | Неподвижная контактная гайка SAE (CR8EB) | пустой | Мотоцикл: 0,7-0,8 мм, Автомобиль: 0,8-0,9 мм |
| EH | 19,0 мм, с частично нарезанной резьбой, длина резьбы 12,7 мм | CM | Наклонно выполненный боковой электрод. Компактный тип (длина изолятора: 18,5 мм). | -8 | 0,8 мм |
| H | 12,7 мм | CS | Наклонно выполненный боковой электрод. Компактный тип (длина изолятора: 18,5 мм). | -9 | 0,9 мм |
| L | 11,2 мм | G, GV | Гонимая свеча зажигания | -10 | 1,0 мм |
| F | Коническая плотная посадка | I | Иридиевый электрод | -11 | 1,1 мм |
| | A-F---10,9 мм | IX | Иридиевый электрод (IX) | -13 | 1,3 мм |
| | B-F---11,2 мм | J | 2 боковых электрода (специальная форма) | -14 | 1,4 мм |
| | B-EF--17,5 мм | K | 2 боковых электрода | -15 | 1,5 мм |
| | BM-F--7,8 мм | -L | Промежуточное калильное число | | |
| пустой | Компактная свеча | -LM | Компактный тип (длина изолятора: 14,5 мм) | | |
| | BM---9,5 мм | N | Специальный боковой электрод | -S | Специальное уплотнительное кольцо |
| | VRM--9,5 мм | P | Платиновый электрод | -E | Специальное сопротивление |
| | CM---9,5 мм | Q | 4 боковых электрода | | |
| | | S | Стандартный тип | | |
| | | T | 3 боковых электрода | | |
| | | U | Тип с полуповерхностным разрядом | | |
| | | VX | Платиновая свеча зажигания (VX) | | |
| | | Y | Центральный электрод с V-образной насечкой | | |
| | | Z | Специальная конструкция | | |

Маркировка свечей зажигания

Здесь приведена стандартная надпись типа. Кроме того, существуют некоторые специальные обозначения.

| Типы свечей зажигания | | Размеры резьбы и раствор шестигранного ключа | | | | |
|---|---|--|-------|---------|----------------------------|-------------|
| D | Свеча с повышенной надёжностью зажигания, с особо тонким электродом | KA | Ø12.0 | 19,0 мм | Уплотнительное кольцо | 14,0 |
| I | Иридиевая свеча | KB | Ø12.0 | 19,0 мм | Уплотнительное кольцо | Vi-Hex 14.0 |
| L | Удлинённая резьбовая часть | MA | Ø10.0 | 19,0 мм | Уплотнительное кольцо | 14,0 |
| P | Платиновая свеча | NA | Ø12.0 | 17,5 мм | Коническая плотная посадка | 14,0 |
| S | Свеча с повышенной надёжностью зажигания, квадратная платиновая вставка | F | Ø14.0 | 19,0 мм | Уплотнительное кольцо | 16,0 |
| Z | Свеча с выступающим искровым зазором | G | Ø14.0 | 19,0 мм | Уплотнительное кольцо | 20,8 |
| Указанные выше обозначения могут быть комбинированными, напр., ILFR..., PLZFR... Наличие буквы "L" (удлинённая резьбовая часть), приоритетно по отношению ко всем другим буквам, обозначающим длину.. напр., • Свеча с уплотнительным кольцом FR5AP-11; длина резьбы 19.0 мм LFR5AP-11; длина резьбы 26.5 мм • Свеча с конической плотной посадкой PTR5C-13; длина резьбы 17,5 мм PLTR6A-10G; длина резьбы 25.0 мм | | J | Ø12.0 | 19,0 мм | Уплотнительное кольцо | 18,0 |
| | | K | Ø12.0 | 19,0 мм | Уплотнительное кольцо | 16,0 |
| | | L | Ø10.0 | 12,7 мм | Уплотнительное кольцо | 16,0 |
| | | M | Ø10.0 | 19,0 мм | Уплотнительное кольцо | 16,0 |
| | | T | Ø14.0 | 17,5 мм | Коническая плотная посадка | 16,0 |
| | | U | Ø14.0 | 11,2 мм | Коническая плотная посадка | 16,0 |
| | | W | Ø18.0 | 10,9 мм | Коническая плотная посадка | 20,8 |
| | | X | Ø14.0 | 9,5 мм | Уплотнительное кольцо | 20,8 |
| | | Y | Ø14.0 | 11,2 мм | Коническая плотная посадка | 16,0 |

P
F
R
5
A
- 11

| Помехоподавляющий резистор | | Калильное число | | Конструкция | Межэлектродный зазор | |
|----------------------------|--------------|-----------------|---|--|---|--|
| R | с резистором | 2 |  горячие холодные | A, B, C... Специальные Suffix код характеристики | пустой | Мотоцикл: 0,7-0,8 мм Автомобиль: 0,8-0,9 мм |
| | | 4 | | | - 7 | 0,7 мм |
| | | 5 | | | - 9 | 0,9 мм |
| | | 6 | | I | Иридиевый электрод | -10 1,0 мм |
| | | 7 | | P | Платиновый электрод | -11 1,1 мм |
| | | 8 | | | -13 | 1,3 мм |
| | | 9 | | | -14 | 1,4 мм |
| | | 10 | | | -15 | 1,5 мм |
| | | | | | -A | без уплотнительного кольца |
| | | | | | -D | Специальное покрытие металлического корпуса |
| | | | | -E | Специальное сопротивление | |
| | | | | -G | Боковой электрод с медным сердечником | |
| | | | | -H | Специальная резьба | |
| | | | | -J | 2 боковых электрода | |
| | | | | -K | Защищённый от вибрации боковой электрод | |
| | | | | -N | Специальный боковой электрод | |
| | | | | -Q | 4 боковых электрода | |
| | | | | -S | Специальное уплотнительное кольцо | |
| | | | | -T | 3 боковых электрода | |

Маркировочные отметки металлических свечей накаливания

Y - 2 0 4 T S 1

| Исполнение / Тип | | Диаметр резьбы | | Напряжение батареи | | Номер серии | Характеристика накаливания | | Материал штифта накаливания | Номер модификации |
|------------------|---|---|-----------------|--------------------|---------|---------------------------|----------------------------------|---|-----------------------------|-------------------|
| Y/YS | Штифтовая свеча накаливания | 1 | 10 мм | 0-4 | 12 В | | Эта цифра является номером серии | A | | |
| YD | Штифтовая свеча накаливания с некорпусным заземлением | 2 | 10 мм | 5-9 | 24 В | J | | Тип SRM | | |
| 3 | | 10 мм | К или без буквы | Стандартный тип | R, M, U | Тип QGS | | | | |
| 4 | | 14 мм | | | T, V | Тип с ускоренным нагревом | | | | |
| 5 | | 10 мм | | | | | | | | |
| 6 | | 10 мм | | | | | | | | |
| 7 | | 10 мм | | | | | | | | |
| 8 | | 18 мм | | | | | | | | |
| 9 | | 12 мм < | | | | | | | | |
| | | *Y-109, Y-159, Y-171 для CATERPILLAR имеют диаметр резьбы 3/8" (ок. 9.5 мм) | | | | | | Пояснение AQGS => Advanced Quick Glow System (Улучшенная система быстрого накаливания) SRM Self Regulating Type (Саморегулирующийся тип, металл) QGS Quick Glow System (Система быстрого накаливания) | | |

Y 1 001 A S 1

| Исполнение / Тип | | Диаметр резьбы | | Номер серии / Напряжение батареи | | Характеристика накаливания | Материал штифта накаливания | Номер модификации |
|-----------------------------|--|----------------|-------|----------------------------------|------|---|-----------------------------|-------------------|
| Штифтовая свеча накаливания | | 1 | 10 мм | 001-899 | 12 В | | | |
| | | 2 | 12 мм | 901-999 | 24 В | J | Тип SRM | |
| | | 4 | 14 мм | | | R, M, U | Тип QGS | |
| | | 8 | 8 мм | | | T, V | Тип с ускоренным нагревом | |
| | | 9 | 9 мм | | | К или без буквы | Стандартный тип | |
| | | | | | | | | |
| | | | | | | Пояснение AQGS => Advanced Quick Glow System (Улучшенная система быстрого накаливания) SRM Self Regulating Type (Саморегулирующийся тип, металл) QGS Quick Glow System (Система быстрого накаливания) | | |

Маркировочные отметки металлических свечей накаливания

Y A 01

| Штифтовая свеча накаливания | Стандартный тип | | Номер серии |
|----------------------------------|-----------------|------------------------|-------------|
| | A | Стандартный тип | Номер серии |
| Диаметр резьбы: 8 мм или 9 мм | E | Тип QGS или Тип SRM | |

DG 183F

| Тип | Номер серии |
|-------------------------------------|-------------|
| Тип с открытой спиралью накаливания | |

Маркировочные отметки керамических свечей накаливания

C Y 01

| Исполнение / Тип | Характеристика накаливания | | Номер серии |
|--------------------------------|----------------------------|---|-------------|
| Керамическая свеча накаливания | X | Тип QGS Quick Glow System (Система быстрого накаливания), с некорпусным заземлением | Номер серии |
| | Y | Тип SRC Self Regulating Type (Саморегулирующийся тип, керамика) | |
| | Z | Тип QGS Quick Glow System (Система быстрого накаливания), с корпусным заземлением | |

Примечания к таблице

- △ = только для автомобилей с иммобилайзером
- ◆ = только для автомобилей без иммобилайзера

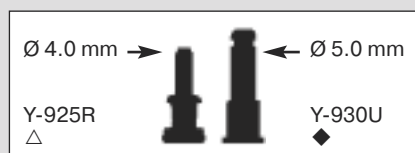

Сравнительный перечень свечей зажигания

| V-LINE | NGK | BERU | BOSCH | Bosch + |
|--------|------------|------------------------|----------------------------|-----------|
| Nr. 1 | BUR6ET | 14GH-7DTUR | WR7LTC+ | +2 |
| Nr. 2 | BPR6E | 14R-6DU 14R-7DU | WR6DC+ WR7DC+ | +12 +1 |
| Nr. 3 | BPR6H | 14R-6BU 14R-7BU | WR6BC WR7BC+ | +10 |
| Nr. 4 | BP6E | 14-6DU 14-7DU | W6DC W7DC | |
| Nr. 5 | BP6EF | 14K-6DU 14K-7DU | H6DC H7DC | |
| Nr. 6 | BPR5E | 14R-8DU 14R-9DU | WR8DC+ WR9DC+ | +3 +16 |
| Nr. 7 | BPR6EF | 14KR-6DU 14KR-7DU | HR6DC+ HR7DC+ | +18 +5 |
| Nr. 8 | BP5E | 14-8DU 14-9DU | W8DC W9DC | |
| Nr. 9 | BPR5EY | - | - | |
| Nr.10 | BPR6EY-11 | - | - | |
| Nr.11 | BCPR6E-11 | - | - | |
| Nr.12 | BCPR6E | - | - | |
| Nr.13 | BPR6ES-11 | 14R-6DUX 14R-7DUX | WR6DCX WR7DCX+ | +21 |
| Nr.14 | BKR6E-11 | 14FR-6DUX 14FR-7DUX | FR6DCX FR7DCX+ | +11 |
| Nr.15 | ZGR5A | 14-8LUR | WR8LC+ WR9LC | +34 |
| Nr.16 | BCP5E | 14F-8DU | F8DC | |
| Nr.17 | BCP6E | 14F-7DU | F6DC F7DC | |
| Nr.18 | BP6H | 14-6BU 14-7BU | W6BC W7BC | |
| Nr.19 | BPR7E | 14R-5DU | WR5DC+ | +15 |
| Nr.20 | BKR6EK | 14FR-6LDU 14FR-7LDU | FR6LDC FR7LDC+ | +7 |
| Nr.21 | BUR5ET-10 | 14GH-8DTURX | WR8LTC+ | +4 |
| Nr.22 | BUR5ET | 14GH-8DTUR | W8LTCR 0.8 | |
| Nr.23 | BKR5EK | 14FR-8LDUOX4 | FLR8LDCU+ | +9 |
| Nr.24 | BKUR6ET-10 | 14FGH7DTURX | F7LTCR | |
| Nr.25 | PTR5A-13 | 14KR-8MPX 14KR-8MUV | HR7MPP302 HR8MCV+ | +3 |
| Nr.26 | BKR6EKC | 14FR-6LDUW | - | |
| Nr.27 | BKUR6ET | 14FGH-6DTUR | FR6KTC | |
| Nr.28 | BKR6E | 14FR-6DU 14FR-7DU | FR6DC+ FR7DC+ | +13 +8 |
| Nr.29 | BKUR5ET | 14FGH-8DTURW | F8KTCR | |
| Nr.30 | BKR6EQUP | 14FR-7DQUP7 | FGR7DQP+ | +48 |
| Nr.31 | PTR5D-10 | - | HR8DPP22U | |
| Nr.32 | BCPR5E | - | - | |
| Nr.33 | BKR5E-11 | 14FR-8DUX | FR8DCX+ | +19 |
| Nr.34 | PZFR5D-11 | 14F-7HPURX2 | FR7HPP33+ | +52 |
| Nr.35 | BKR5E | 14FR-8DU | FR8DC+ FR9DC | +6 |
| Nr.36 | BKR5EZ | - | - | |
| Nr.37 | PFR6Q | 14F-7 DPUR02 | FR7KPP33+ | +50 |
| Nr.38 | BKR6EZ | - | FR7DE FR6KDC+ FR7KDC | +53 |
| Nr.39 | BKR5EYA-11 | 14FR8KU0U | FR8KCU | |

V-Line – концепция сбыта со многими преимуществами

1. Система числовой кодировки:

Числа от 1 до 39 позволяют быстро найти нужную свечу зажигания.

2. Компактность:

Небольшая занимаемая площадь благодаря компактным размерам. Тем самым остается больше места для размещения других товаров.

3. Привлекательная упаковка:

Яркая упаковка привлекает покупателей и способствует более быстрой продаже.

4. Большая скорость оборота товаров:

39 типов свечей подходят для 97 % всех легковых автомобилей. Это повысит Вашу рентабельность.

5. Сбыт через специализированные магазины:

Отсутствие конкуренции с универсальными магазинами и супермаркетами.

6. Снижение расходов:

Низкие складские расходы увеличивают Вашу прибыль.

7. Экологический фактор:

Большая надежность зажигания. Тем самым уменьшение расхода топлива, выделения выхлопных газов и более длительный период эксплуатации катализатора, в результате лучшее отношение покупателей. Экологически чистая картонная упаковка без блистера.

8. Реклама для конечного потребителя:

Фирма NGK заботится об увеличении спроса у Ваших клиентов.



Весь ассортимент из 39 наименований Вы можете представительно и обзорно разместить в напольном контейнере. Благодаря интегрированному классификационному списку поиск нужной свечи зажигания становится просто детской забавой!



Свечи зажигания V-Line предлагают преимущества в рамках всей серии

ОСОБЕННО В СОВРЕМЕННЫХ ДВИГАТЕЛЯХ, ТОПЛИВОВОЗДУШНАЯ СМЕСЬ КОТОРЫХ ДОВОДИТСЯ ДО ОЧЕНЬ БЕДНОЙ СТЕПЕНИ НАСЫЩЕНИЯ В ИНТЕРЕСАХ СОКРАЩЕНИЯ ВЫБРОСОВ ВРЕДНЫХ ВЕЩЕСТВ, КОНСТРУКЦИЯ NGK В ЛЮБЫХ УСЛОВИЯХ ОБЕСПЕЧИВАЕТ АБСОЛЮТНО НАДЕЖНОЕ ВОСПЛАМЕНЕНИЕ СМЕСИ, В ТОМ ЧИСЛЕ И В ЭКСТРЕМАЛЬНЫХ УСЛОВИЯХ ЭКСПЛУАТАЦИИ!

Технические преимущества:

использование специального материала изоляторов дает возможность удлинить вершину теплового конуса изолятора. Кроме того, был оптимизирован медный сердечник внутри центрального электрода. Обе меры способствуют еще лучшему отводу тепла. Увеличенный таким образом температурный диапазон нормальной работы обеспечивает надежный пуск и еще более стабильную характеристику зажигания даже в экстремальных условиях эксплуатации двигателя и автомашины.



V-Line № 1, 21, 22, 24, 27, 29

V-Line № 1, 21, 22, 24, 27, 29 Свеча зажигания с 3-мя боковыми электродами для концерна VW

Фирма NGK выпускает этот тип свечей зажигания специально для автомобилей производства концерна VW. Ими могут оснащаться почти все новые модели (смотри перечень соответствия). Интервалы замены свечей согла-

сованы с интервалами техосмотров предписанными изготовителем автомобилей.



V-Line № 2-12, 14-19, 28, 32, 33, 35, 36, 38, 39

V-Line № 2 - 12, 14 - 19, 28, 32, 33, 35, 36, 38, 39

С точки зрения технологии принцип действия отличается гениальной простотой, но еще и хорошей эффективностью: в центральном электроде свечи зажигания V-Line находится V-образная засечка. Вследствие этого воспламеняющая искра перескакивает на наружную сторону центрального электрода. В этом

месте скапливается способная воспламениться топливовоздушная смесь в большем количестве, чем непосредственно между электродами. Дополнительный плюс: требуется меньше вторичного напряжения системы зажигания. Тем самым повышается надежность зажигания!



V-Line № 20, 23

V-Line № 20, 23

Принцип действия свечи зажигания для BMW: если на вершине теплового конуса изолятора имеются токопроводящие отложения, то утекающее вторичное напряжение системы зажигания "перехватывается", а между изолятором и боковым электродом возникает воспламеняющая искра. При этом

отложения сажи удаляются и топливовоздушная смесь надежно воспламеняется.

V-Line

V-Line № 25

Для моделей FORD, оборудованных двигателями ZETEC, фирма NGK разработала двойную платиновую свечу зажигания PTR5A-13. Преимущества платиновых электродов заключаются в том, что требуется меньше вторичного напряжения системы зажигания. Таким образом появилась

возможность увеличить зазор между электродами с тем, чтобы добиться стабильного сгорания и плавного холостого хода. Благодаря улучшенным характеристикам воспламенения удалось оптимизировать как эмиссию неочищенных выбросов, так и крутящий момент.



V-Line № 25

V-Line № 26

В сотрудничестве с FIAT фирма NGK разработала свечу зажигания ВКР6ЕКС. Буква "С" обозначает специальную свечу зажигания для двигателей производства концерна FIAT. Свеча ВКР6ЕКС безупречно работает даже в труднейших условиях эксплуатации — от движения по принципу "тронулся-остановился" при низкой температуре сгорания до максимальной

температурной нагрузки двигателя при его полной нагрузке. Результаты испытаний показывают, что особая конструкция двух боковых электродов гарантирует высочайшую воспламеняемость, а также требуемый срок службы свечей зажигания в пределах рекомендованного фирмой Fiat интервала замены свечей зажигания.



V-Line № 26





V-Line № 30

V-Line № 30

Результатом тесного сотрудничества между BMW и NGK явилась разработка свечи зажигания BKR6EQUF с большим сроком службы, оснащенной центральным электродом из платины и 4-мя боковыми электродами с современной технологией полуповерхностного разряда. Применение техники полуповерхностного разряда возможно только благодаря специальному дизайну внутреннего окончания изолятора. С помощью этой техники обеспечивается образование искры только между теми электродами, которые в данный момент времени обеспечивает надежное зажигания воздушно-топливной смеси. Так как каждая искра перед тем,

как перескочить от изолятора на боковой электрод, сначала «скользит» через окончание внутренней части изолятора, возможно возникший нагар мгновенно удаляется, и таким образом предотвращаются пропуски в зажигании. Оптимальные параметры холодного запуска при очень низких температурах и высочайшая надежность зажигания даже при экстремальных условиях эксплуатации таким образом гарантируются.

Этот новый тип свечей NGK применяется серийно на автомобилях BMW, начиная с 1997 года выпуска. Допуск к установке этого типа свече на определенные более поздние автомобили BMW, начиная с 1987 года выпуска, был одобрен задним числом.



V-Line № 31, 34, 37

V-Line № 31, 34, 37

Для моделей FORD, оборудованных двигателями ENDURA, фирма NGK разработала двойную платиновую свечу зажигания PTR5D-10 (V-Line № 31). Преимущества платиновых электродов заключаются в том, что требуется меньше вторичного напряжения системы зажигания. Таким образом появилась

возможность увеличить зазор между электродами с тем, чтобы добиться стабильного сгорания и плавного холостого хода. Благодаря улучшенным характеристикам воспламенения удалось оптимизировать как эмиссию неочищенных выбросов, так и крутящий момент.

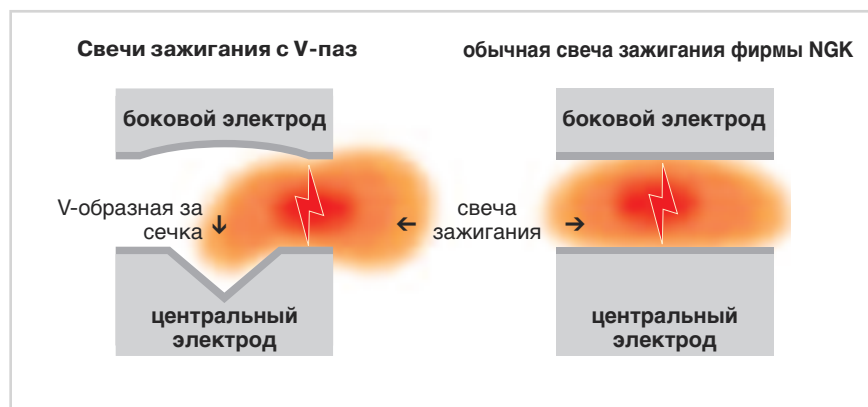

Обзор V-Line

| V-Line | Тип | Производители автомобилей |
|--------|------------|---|
| 1 | BUR6ET | AUDI, FIAT, LANCIA, SEAT, SKODA, VW |
| 2 | BPR6E | ALFA ROMEO, AUSTIN, AUTOBIANCHI, BEDFORD, BMW, CHEVROLET, CHRYSLER, DAEWOO, DAIHATSU, FIAT, FORD, HONDA, INNOCENTI, ISUZU, KIA, LADA, LANCIA, LAND ROVER, LOTUS, MAZDA, MERCEDES-BENZ, MG, MITSUBISHI, MORGAN, NISSAN, OPEL, PANTHER, PININFARINA, PORSCHE, PROTON, RENAULT, ROVER, SEAT, SUBARU, SUZUKI, TALBOT, TVR, VAUXHALL, VOLVO, ZASTAVA |
| 3 | BPR6H | BEDFORD, FORD, OPE |
| 4 | BP6E | ALFA ROMEO, ASTON MARTIN, AUDI, AUSTIN, AUTOBIANCHI, BEDFORD, BMW, BOND, CITROËN, FIAT, FORD, FSO, GLAS, INNOCENTI, ISUZU, LADA, LANCIA, LAND ROVER, MASERATI, MERCEDES-BENZ, MG, MITSUBISHI, MORGAN, NISSAN, OPEL, PEUGEOT, RENAULT, ROVER, SAAB, SEAT, SUBARU, TALBOT, TRABANT, TRIUMPH, VAUXHALL, VOLVO, VW, WARTBURG, ZASTAVA, ZAZ |
| 5 | BP6EF | ALPINE, AUSTIN, CITROËN, LAND ROVER, MERCEDES-BENZ, PEUGEOT, PUCH, RENAULT, ROVER, TALBOT, TRIUMPH, VOLVO |
| 6 | BPR5E | ASIA MOTORS, BEDFORD, DAIHATSU, FIAT, HONDA, MARUTI, MAZDA, MITSUBISHI, NISSAN, OPEL, PROTON, RENAULT, SEAT, SUZUKI, TOYOTA, TRIUMPH, VAUXHALL, ZASTAVA |
| 7 | BPR6EF | FORD, LANCIA, RENAULT, VOLVO |
| 8 | BP5E | BMW, DAIMLER, HYUNDAI, ISUZU, JAGUAR, LAND ROVER, MG, MITSUBISHI, NISSAN, PEUGEOT, RENAULT, TRIUMPH, VW |
| 9 | BPR5EY | DAIHATSU, HONDA, SUZUKI, TOYOTA, VW |
| 10 | BPR6EY-11 | DAIHATSU, HONDA, TOYOTA |
| 11 | BCPR6E-11 | ACURA, FORD, FORD USA, HONDA, LADA, MAZDA, MITSUBISHI, NISSAN, ROVER, SAAB, SUBARU |
| 12 | BCPR6E | ASTON MARTIN, AUTOBIANCHI, CHEVROLET, CHRYSLER, CITROËN, DAIMLER, FIAT, FORD, FSO, JAGUAR, LANCIA, MAZDA, MORGAN, NISSAN, PEUGEOT, PONTIAC, RENAULT, ROVER, SAAB, SKODA, TVR, VOLVO |
| 13 | BPR6ES-11 | HYUNDAI, ISUZU, KIA, MAZDA, MITSUBISHI, NISSAN, OPEL, SUBARU |
| 14 | BKR6E-11 | CHEVROLET, DAEWOO, DAIHATSU, HONDA, ISUZU, KIA, MAZDA, MITSUBISHI, NISSAN, PEUGEOT, PROTON, ROVER, SUBARU, SUZUKI |
| 15 | ZGR5A | BERTONE, BMW |
| 16 | BCP5E | CITROËN, DAEWOO, MERCEDES-BENZ, PEUGEOT, RENAULT, SAAB, SSANGYONG |
| 17 | BCP6E | ALFA ROMEO, CITROËN, MERCEDES-BENZ, NISSAN, PEUGEOT, PUCH, RENAULT, ROVER |
| 18 | BP6H | CITROËN, DACIA, DAF, FORD, MERCEDES-BENZ, OPEL, PORSCHE, RENAULT, SEAT, SKODA, TALBOT, TRABANT, VOLVO, WARTBURG |
| 19 | BPR7E | ALFA ROMEO, AUSTIN, AUTOBIANCHI, FIAT, FORD, LANCIA, LOTUS, MITSUBISHI, PININFARINA, PORSCHE, RENAULT, SUBARU, TALBOT, VOLVO |
| 20 | BKR6EK | ALPINA, BERTONE, BMW, CITROËN, DAEWOO, FIAT, LANCIA, MERCEDES-BENZ, OPEL, PEUGEOT, PORSCHE, SAAB, VAUXHALL, WIESMANN |
| 21 | BUR5ET-10 | AUDI, SAAB, SEAT, VW |
| 22 | BUR5ET | AUDI, SEAT, VW |
| 23 | BKR5EK | CHEVROLET, CITROËN, DAEWOO, FIAT, LANCIA, NISSAN, OPEL, PEUGEOT, RENAULT, SAAB, VAUXHALL |
| 24 | BKUR6ET-10 | AUDI, MERCEDES-BENZ, SEAT, SKODA, VW |
| 25 | PTR5A-13 | CHEVROLET, FORD, HUMMER, MAZDA, MORGAN |
| 26 | BKR6EKC | DAIHATSU, FIAT, LANCIA, LOTUS |
| 27 | BKUR6ET | FIAT, LANCIA, SEAT, VW |
| 28 | BKR6E | AUDI, AUSTIN, CATERHAM, CHRYSLER, CITROËN, DACIA, FIAT, HYUNDAI, KIA, LADA, LAND ROVER, MAZDA, MERCEDES-BENZ, NISSAN, OPEL, PANTHER, PEUGEOT, PORSCHE, RENAULT, ROVER, SKODA, SUZUKI, VOLVO, VW |
| 29 | BKUR5ET | MERCEDES-BENZ, VW |
| 30 | BKR6EQUP | ALPINA, AUDI, BENTLEY, BMW, LAND ROVER, MINI, MORGAN, PORSCHE, ROLLS-ROYCE, VOLVO |
| 31 | PTR5D-10 | FORD, MAZD |
| 32 | BCPR5E | CITROËN, PEUGEOT, RENAULT, SKODA |
| 33 | BKR5E-11 | CHEVROLET, DAEWOO, DAIHATSU, HYUNDAI, INFINITI, KIA, MAZDA, MITSUBISHI, NISSAN, SUBARU |
| 34 | PZFR5D-11 | FORD, SEAT, SKODA, VW |
| 35 | BKR5E | KIA, MAZDA, NISSAN, VW |
| 36 | BKR5EZ | CITROËN, FIAT, LANCIA, PEUGEOT, RENAULT |
| 37 | PFR6Q | AUDI, BENTLEY, SEAT, SKODA, VW |
| 38 | BKR6EZ | CITROËN, DACIA, FIAT, LANCIA, NISSAN, PEUGEOT, RENAULT |
| 39 | BKR5EYA-11 | TOYOTA |

LPG LaserLine – Единственный в своем роде ассортимент

До сих пор все попытки найти на рынке специальный ассортимент свечей зажигания для автомобилей, эксплуатируемых на газе (LPG/CNG), были безрезультатны. Компания NGK Spark Plug Europe восполнила этот пробел.

- Для двигателей, эксплуатируемых на газе: LPG (сжиженный природный газ) и CNG (сжатый природный газ)
- Свечи зажигания с электродами из благородных металлов: метод лазерной сварки
- Специальное покрытие: защита и облегченный демонтаж
- Беспроблемный монтаж: предустановленный межэлектродный зазор, не требующий регулировки
- Всего 8 типов: покрытие рынка 95%

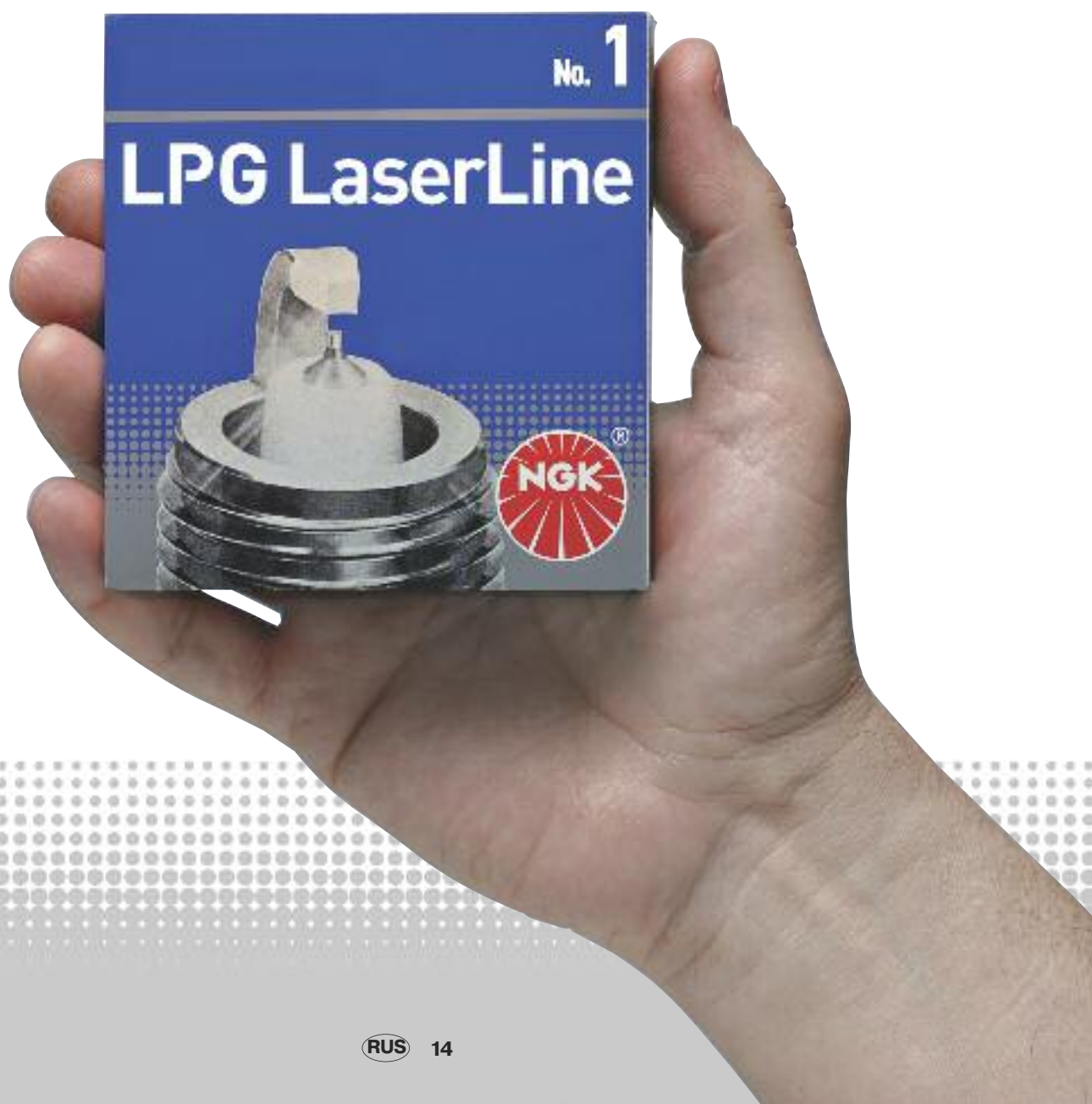

LPG LaserLine – идеальное решение для двигателей, эксплуатируемых на газе

Серия LPG LaserLine впервые предлагает на вторичном рынке ассортимент свечей зажигания, разработанный специально для работающих на газе двигателей. Для торговых точек и СТО это значит: переоборудование автомобилей и их сервисное обслуживание станут ощутимо легче и надежнее.

Автомобилисты, переоборудующие свои автомобили для работы на газе, выигрывают за счет более низких цен на данный вид топлива. Число таких переоборудований растет из года в год. Данный тренд дает возможность торговым точкам и СТО увеличить свои доходы.

До настоящего момента подбор правильной свечи зажигания для автомобилей, переоборудованных для работы на газе, предполагал учет огромного числа факторов, что

зачастую было связано с увеличением объема работ. Ведь процесс сгорания газа существенно отличается от сгорания бензина: газо-воздушную смесь гораздо сложнее воспламенить.

Пробивное напряжение свечи зажигания увеличивается (см. график), а вместе с ним и риск выхода из строя катушки зажигания. К этому надо добавить, что сгорание газо-воздушной смеси происходит при более высоких температурах. Материалы, из которых традиционно изготавливают электроды и корпус свечи зажигания, корродируют в такой среде гораздо быстрее. Кроме того, свеча зажигания, в двигателях, работающих на газе, должна отводить больше тепла. До сих пор лучшим решением проблемы считалась замена стандартной свечи

зажигания на свечу зажигания, произведенную с использованием благородных металлов, с другим калильным числом, а в отдельных случаях и дополнительная подгонка межэлектродного зазора.

Сейчас мы можем предложить лучшую альтернативу: специальные свечи зажигания ассортимента **LPG LaserLine**. Данный ассортимент покрывает более 90% парка европейских автомобилей, которые могут быть переоборудованы для работы на газе. В отдельных странах эта цифра достигает 97%. Таким образом, серия **LPG LaserLine** предлагает идеальные свечи зажигания практически для каждого европейского автомобиля, который может быть переоборудован для работы на газе.

Пробивное напряжение свечи зажигания возрастает при работе на газе

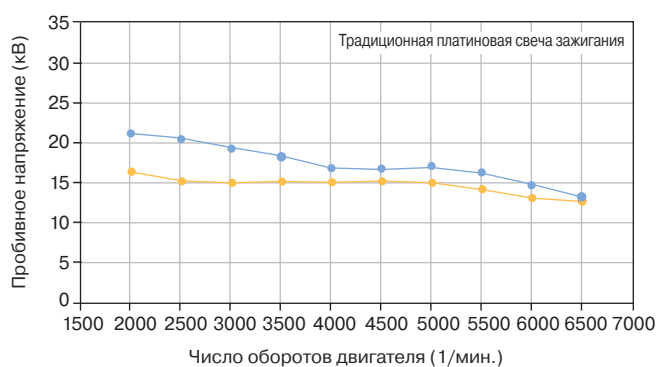

Бензин А-98 — Межэлектродный зазор 0,80 мм
Сжиженный газ (LPG) — Межэлектродный зазор 0,80



LPG LaserLine – передовая технология для двигателей, эксплуатируемых на газе



1. Высокотехнологичные электроды

Свечи зажигания **LPG LaserLine** имеют центральный электрод с иридиевым наконечником и боковой электрод с платиновой напайкой. Данные чипы из благородных металлов прирабатываются крайне трудоемким методом лазерной сварки, запатентованным компанией NGK. Преимущество: благородные металлы противостоят неблагоприятным условиям эксплуатации на газе. Межэлектродный зазор практически на протяжении всего срока службы остается неизменным.

2. Индивидуальный межэлектродный зазор

На каждой свече зажигания типа **LPG LaserLine** предварительно выставляется идеальный для эксплуатации на газе межэлектродный зазор. Таким образом, дополнительная подгонка не требуется.

3. Оптимальный отвод тепла

Медный стержень бокового электрода каждой свечи зажигания **LPG LaserLine** улучшает отвод тепла, позволяя оптимально регулировать более высокий температурный уровень при сгорании газа. Конструктивные особенности еще лучше защищают данные свечи зажигания от образования нагара.

4. Теплозащитный экран для корпуса

Корпус каждой свечи зажигания **LPG LaserLine** покрыт специальным сплавом, который защищает его от высоких температур и более высокой коррозионной опасности. Ни один другой производитель не может в настоящий момент предложить подобное покрытие.

5. Разгрузка катушки зажигания

Исследования компании NGK показали: при эксплуатации на газе пробивное напряжение свечи зажигания возрастает дополнительно на 7.000 Вольт – это настоящий тест на прочность для катушек зажигания.



Центральный электрод с иридиевым наконечником и боковой электрод с платиновой чипом – металлы приварены методом лазерной сварки – обеспечивают высочайшую износостойкость и надежное зажигание на протяжении всего срока службы.

Иридиевый центральный электрод свечей **LPG LaserLine** диаметром всего 0,6 мм противодействует этому. Эти свечи обходятся крайне низким напряжением зажигания. Кроме того, их форма обеспечивает оптимальное распространение фронта пламени.

LPG LaserLine – Оптимальное покрытие рынка

Серия LPG LaserLine включает в себя 8 специальных свечей зажигания для воспламенения газо-воздушной смеси. Данные свечи подходят более чем для 90% всех годных для переоборудования автомобилей на европейском рынке.

В прилагаемой таблице Вы можете увидеть 8 примеров применения свечей зажигания типа **LPG LaserLine**. Полный

список применимости Вы можете найти в каталоге свечей зажигания NGK, в системе

TecDoc и на сайте www.ngkntk.ru в он-лайн-овом режиме подбора продукции.

Примеры применения

| Тип LPG | Автомобиль | Двигатель |
|---------|-----------------------|-----------------|
| LPG 1 | Audi A6 2.4l V6 | BDV |
| LPG 2 | Volvo 940i 2.3l | B 230 FT |
| LPG 3 | Saab 9-5 2.3l | B235L |
| LPG 4 | Ford Focus 1.6l | FYDA Zetec SE |
| LPG 5 | Ford Mondeo 2.0 | CJBA Duratec HE |
| LPG 6 | VW Multivan T5 2.8l | AXK |
| LPG 7 | Peugeot 307 1.6l | TU5 JP4 NFU |
| LPG 8 | Fiat Grande Punto 1.4 | 350A1000 |

Принцип работы двигателя, переоборудованного для эксплуатации на газе

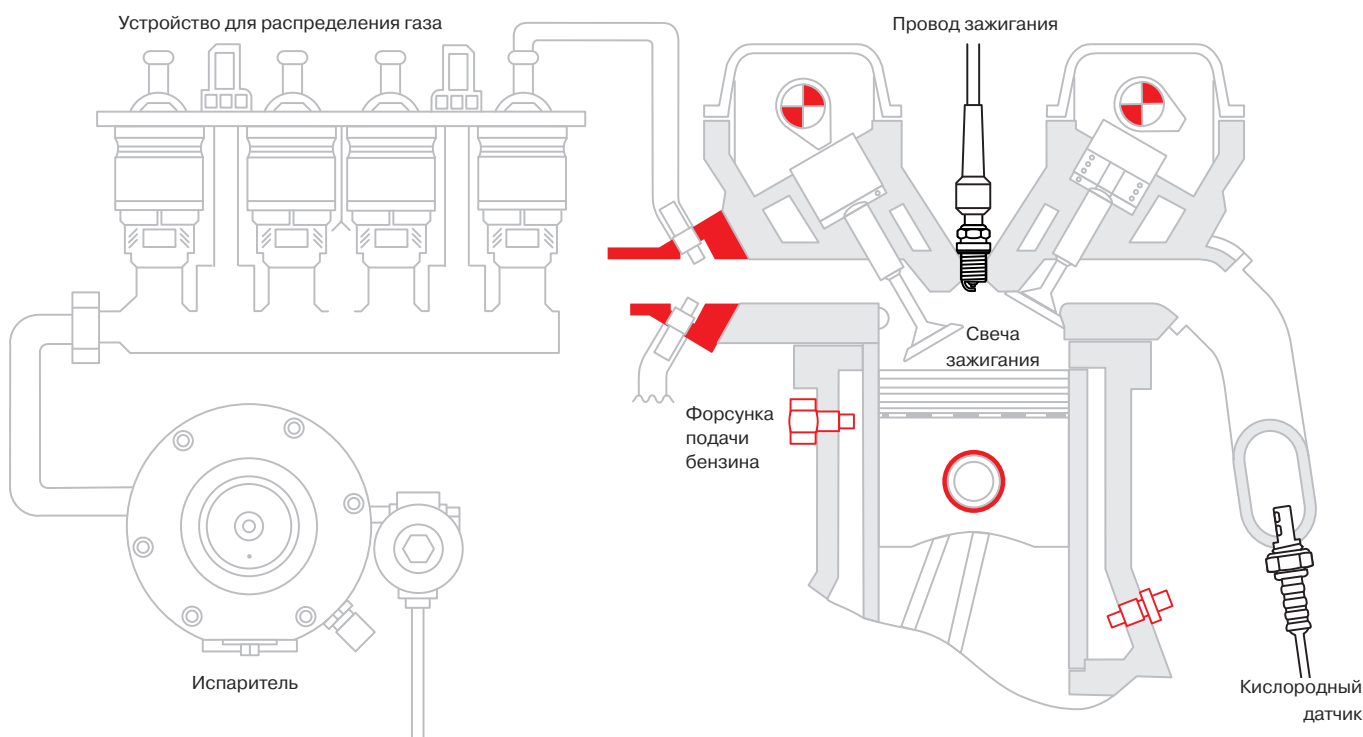

D-POWER^{NGK}



D-Power: Новейшая дизельная технология в одном ассортименте

Ассортимент свечей накаливания D-Power содержит 62 свечи и всегда предлагает идеальное решение почти для всех вариантов применения в автомобиле. Таким путём покрывается почти 90 % европейского парка дизельных автомобилей.

Свечи накаливания D-Power обеспечивают быстрый и экологически безопасный холодный запуск, даже при самых низких окружающих температурах. Это потому, что

они обладают ноу-хау ведущего поставщика свечей накаливания: Так, кроме стандартных свечей накаливания с металлическим штифтом в ассортименте имеются также и керамические свечи накаливания, например, свечи накаливания NHTC с полностью керамическим нагревательным элементом; эти свечи применяют в серийном исполнении компании VW, Mercedes и Mitsubishi. Все свечи накаливания с улучшенной системой быстрого

накаливания Advanced Quick Glow System (AQGS) входят в серию D-Power. Эта технология используется компанией Fiat в серийном производстве.

Испытанная кодовая система NGK позволяет быстро найти оптимальную свечу накаливания для каждого автомобиля и, при необходимости, дополнительно заказать.

Краткие характеристики ассортимента:

- Охват рынка на почти 90 %
- Для почти всех моделей автомобилей в TecDoc
- Быстрая идентификация подходящей свечи накаливания благодаря кодовой системе NGK
- Простое пополнение запасов и содержание склада
- Керамические свечи накаливания и свечи с металлическим штифтом в одном ассортименте
- Много свечей накаливания из





Керамические свечи накаливания

По сравнению со свечой накаливания с металлическим штифтом, нагревательная спираль керамической свечи накаливания имеет особо высокую температуру плавления. Кроме того, она покрыта силиконовым нитритом, чрезвычайно прочным керамическим материалом. Комбинация нагревательной спирали с керамической оболочкой позволяет достигать высоких температур и имеет очень короткое время разореза, благодаря отличной теплопроводности. К тому же, керамические свечи накаливания тоньше. Это важно, поскольку в современных двигателях мало места. В свече накаливания SRC (Self Regulating Ceramic - саморегулирующаяся керамика) нагревательный элемент изготовлен из керамики, с остеклованной металлической нагревательной спиралью. Свеча НТС (High Temperature Ceramic - высокотемпературная керамика) или ННТС (New High Temperature Ceramic - новая высокотемпературная керамика) снабжена нагревательным элементом и нагревателем из керамики.

Керамическая свеча накаливания ННТС специально разработана компанией NGK для того, чтобы производители автомобилей могли выдерживать требования нормы токсичности ОГ Euro 4 и Euro 5. Одной из целей нормы является снижение степени сжатия в дизельных двигателях. Свечи накаливания ННТС достигают температуры 1000 °С менее, чем за 2 секунды и могут в течение более 10 минут, при температуре до 1350 °С выполнять вторичное накаливание. Даже при низком коэффициенте сжатия гарантировано оптимальное воспламенение. Кроме того, свеча накаливания ННТС может целенаправленно промежуточно накаливаться, чтобы предотвратить остывание пылевого фильтра во время фаз толкающей силы.

Керамические свечи накаливания: Технически оптимальный вариант

Уже в течение более 20 лет изготовители автомобилей серийно применяют керамические свечи накаливания производства компании NGK. Но можно ли заменить эти свечи накаливания на сравнительно дешёвые свечи с металлическим штифтом?

Ответ: Конечно, многое "можно" сделать. Вопрос лишь состоит в том, какова степень риска. Если на заводе-изготовителе установлены керамические свечи накаливания NGK, надлежит в случае ремонта заменять их также только на керамические свечи накаливания NGK.

Причина: Эти свечи накаливания разработаны специально для соответствующих двигателей. Керамические свечи накаливания NGK гарантируют долгий срок службы и обеспечивают надёжное и быстрое воспламенение, даже при очень низкой окружающей температуре. Одновременно они способствуют производству меньшего количества вредных отработавших газов. Хотя они несколько дороже, чем металлические свечи накаливания, но: При очень низких температурах металлические свечи накаливания могут иметь проблемы запуска в соответствующих двигателях.

Примечание!

При переходе на металлические свечи накаливания необходимо заменить все свечи накаливания - в том числе и исправные.

Обзор D-Power

| D-Power | Тип | Производители автомобилей |
|---------|----------|--|
| 1 | Y-924J | ALFA ROMEO, ARO, BMW, CHRYSLER, CITROËN, FIAT, FORD, FSO, HYUNDAI, INNOCENTI, JEEP, LADA, LANCIA, LAND ROVER, MERCEDES-BENZ, OPEL, PEUGEOT, RENAULT, ROVER, SEAT, SUZUKI, TALBOT, VAUXHALL |
| 2 | Y-918J | AUDI, FSO, SEAT, SKODA, VOLVO, VW |
| 3 | Y-910J | CITROËN, FIAT, FORD, MAZDA, OPEL, PEUGEOT, RENAULT, ROVER, VAUXHALL |
| 4 | Y-732J | AUDI, DACIA, FORD, MITSUBISHI, NISSAN, OPEL, RENAULT, SEAT, SKODA, SUZUKI, VAUXHALL, VOLVO, VW |
| 5 | Y-937J | FORD |
| 6 | Y-916J | DAEWOO, MERCEDES-BENZ, SSANGYONG |
| 7 | Y-506J | OPEL, RENAULT, VAUXHALL |
| 8 | CY03 | OPEL |
| 9 | – | CITROËN, PEUGEOT, ROVER |
| 10 | Y-503J | CITROËN, FIAT, NISSAN, PEUGEOT, RENAULT, ROVER |
| 11 | Y-745U | CHRYSLER, JEEP, MERCEDES-BENZ, SSANGYONG |
| 12 | Y-516J | RENAULT |
| 13 | Y-733J | mitsubishi |
| 14 | Y-748U | KIA, OPEL, SAAB, VAUXHALL |
| 15 | Y-913J | RENAULT, VOLVO |
| 16 | Y-925J | MERCEDES-BENZ |
| 17 | Y-730U | HONDA, LAND ROVER, RENAULT, ROVER |
| 18 | – | DACIA, MITSUBISHI, NISSAN, OPEL, RENAULT, SUZUKI, VOLVO |
| 19 | Y-927J | RENAULT |
| 20 | Y-741U | AUDI, CHRYSLER, FORD, JEEP, OPEL, SEAT, SKODA, VAUXHALL, VW |
| 21 | CY57 | HYUNDAI, MITSUBISHI |
| 22 | Y-740U | HONDA, RENAULT, VOLVO |
| 23 | – | FIAT, OPEL |
| 24 | Y-504J | CITROËN, FIAT, LANCIA, PEUGEOT, SUZUKI |
| 25 | Y-933J | ARO, MITSUBISHI, RENAULT, VOLVO |
| 26 | Y-747U | ALFA ROMEO, FIAT, LANCIA |
| 27 | Y-524J | FORD |
| 28 | Y-711J | ISUZU, OPEL, VAUXHALL |
| 29 | Y-928U | FIAT, LANCIA |
| 30 | Y-930U | MERCEDES-BENZ |
| 31 | Y-501U | AUDI, SKODA, VW |
| 32 | Y-507J | BMW, LAND ROVER, MG, ROVER |
| 33 | – | CITROËN, PEUGEOT, ROVER |
| 34 | Y-729U | LAND ROVER |
| 35 | Y-525J | FORD, JAGUAR |
| 36 | Y-534J | ALFA ROMEO, FIAT, LANCIA, OPEL, SUZUKI, VAUXHALL |
| 37 | Y-523J | OPEL, VAUXHALL |
| 38 | Y-746J | MERCEDES-BENZ |
| 39 | Y-701J | FORD, KIA, MAZDA, SUZUKI |
| 40 | YE04 | CITROËN, FORD, MAZDA, PEUGEOT, SUZUKI, VOLVO |
| 41 | Y-929U | DAEWOO, MERCEDES-BENZ |
| 42 | Y-541J | HONDA, OPEL, VAUXHALL |
| 43 | Y-939J | FIAT |
| 44 | Y-531J | TOYOTA |
| 45 | Y-542J | TOYOTA |
| 46 | Y-543J | FIAT, SMART |
| 47 | Y-547AS | BMW |
| 48 | YE14 | AUDI, MITSUBISHI, SEAT, SKODA, VW |
| 49 | Y-609AS | AUDI, VW |
| 50 | Y-607AS | AUDI, SEAT, SKODA, VW |
| 51 | Y8002AS | CHRYSLER, MERCEDES-BENZ |
| 52 | CZ104 | AUDI, SEAT, SKODA, VW |
| 53 | CZ106 | MERCEDES-BENZ |
| 54 | CZ303 | MERCEDES-BENZ |
| 55 | CZ304 | AUDI, SEAT, SKODA, VW |
| 56 | Y-1005J | CITROËN, FIAT, FORD, LANCIA, PEUGEOT |
| 57 | Y-1002AS | AUDI, SKODA, VW |
| 58 | Y-8001AS | CITROËN, PEUGEOT |
| 59 | Y-1007J | MITSUBISHI |
| 60 | Y-603J | OPEL |
| 61 | Y-519J | NISSAN |
| 62 | Y8003J | ALFA ROMEO, FIAT, LANCIA, OPEL, SUZUKI |



2011-2012

Гоночные свечи зажигания фирмы
NGK



Series of NGK racing spark plugs

New colour releases resistor plugs.

| Thread size (Hexagon size) | Spark plug type | Spark plug number | Heat rating | Terminal nut type | Fringend | Electrode material | | |
|--------------------------------------|-------------------------|-------------------|-----------------|-------------------|----------|--------------------|--------------|--------------|
| | | | | | | Center | Ground | |
| φ 14 × 19mm (20.8Hex) | BP-E | R4304A- | 7,8,9,10 | | | Gold Palladium | Nickel Alloy | |
| | | R6918B- | 7,8,9 | | | Platinum | Nickel Alloy | |
| | | R6918C- | 9 | | | Platinum | Nickel Alloy | |
| | | R6021E- | 8,9,10 | | | Nickel Alloy | Nickel Alloy | |
| | | R7376- | 7,8,9,10 | | | Iridium | Platinum | |
| | | R5649- | 9,10,11 | | | Nickel Alloy | — | |
| | | R6712- | 9,10 | | | Nickel Alloy | — | |
| φ 14 × 22mm (20.8Hex) | Short | R6179A- P | 105,11 | | | Platinum | Platinum | |
| | | R7376B- | 9,10 | | | Iridium | Platinum | |
| φ 14 × 22mm (16.0Hex) | Short | R7282A- #2 | 10,105,11 | | | Iridium | Platinum | |
| φ 14 × 19mm (16.0Hex) | Short | R7282- #2 | 7,8,9,10,105,11 | | | Iridium | Platinum | |
| | | R7282M- #2 | 11,115 | | | Iridium | Platinum | |
| | | R6688A- | 8,9,10 | | | Nickel Alloy | Nickel Alloy | |
| | BK-E(ISO)#1 | R7433- | 8,9,10 | | | Iridium | Nickel Alloy | |
| | | R7434- | 8,9,10 | | | Iridium | Platinum | |
| | BC-E(ISO)#1 | R7279- | 10 | | | Iridium | Platinum | |
| | | R6601- | 8,9,10,11 | | | Nickel Alloy | — | |
| | | R6711- | 9,10 | | | Nickel Alloy | — | |
| | | R7436- | 8,9,10 | | | Iridium | Nickel Alloy | |
| | BCP-E(JIS) | R7436- | 8,9,10 | | | Iridium | Platinum | |
| | BC-E(JIS) | R5883- | 9,10,11 | | | Nickel Alloy | — | |
| | | R6690- | 9,10,11 | | | Nickel Alloy | — | |
| | | R7437- | 8,9,10 | | | Iridium | Nickel Alloy | |
| | φ 14 × 26.5mm (16.0Hex) | LFR | long reach | R7438- | 8,9,10 | | Iridium | Platinum |
| | | | long reach | R7437- | 8,9,10 | | Iridium | Nickel Alloy |
| φ 14 × 12.7mm(20.8Hex) | B-H | R5525- | 7,8,9,10,11 | | | Gold Palladium | Nickel Alloy | |
| | | R5530- | 8,9,10,11 | | | Gold Palladium | Platinum | |
| φ 14 × 21.5mm(20.8Hex) | Rotary RX-7 | R6726- | 9,10,105,11,115 | | | Platinum | Platinum | |
| | | R7420- | 9,10,105,11 | | | Iridium | Platinum | |
| φ 14 × 21mm(20.8Hex) | Rotary RX-8 L | R7440A- L | 9,10 | | | Iridium | Platinum | |
| φ 14 × 19mm(20.8Hex) | Rotary RX-8 T | R7440B- T | 10,11 | | | Iridium | Platinum | |
| φ 12 × 26.5mm(16.0Hex) | LKR-E | long reach | R2558B- | 8,9,10 | | Iridium | Platinum | |
| φ 12 × 26.5mm(14.0Hex) | LKAR-E | long reach | R2558A- | 8,9,10 | | Iridium | Platinum | |
| φ 12 × 19mm(16.0Hex) | DC-E | R2549- | 9,10,11 | | | Nickel Alloy | — | |
| | | R2525- | 9,10,11 | | | Platinum | Nickel Alloy | |
| φ 10 × 26.5mm(14.0Hex) | LMAR-E | long reach | R0465B- | 10 | | Nickel Alloy | — | |
| φ 10 × 19mm(16.0Hex) | C-E | R0373A- | 8,9,10 | | | Iridium | Platinum | |
| | | R0045G- | 10,11 | GAP1.4 | | Nickel Alloy | — | |
| | | R0045J- | 9,10,11,12 | GAP1.1 | | Nickel Alloy | — | |
| | | R0045Q- | 10,11 | GAP1.1 | | Nickel Alloy | — | |
| φ 10 × 19mm Half thread (16.0Hex) | C-EH | R0409B- | 8,9,10 | | | Iridium | Nickel Alloy | |
| φ 10 × 12.7mm(16.0Hex) | C-H | R0161- | 9,10,11 | | | Nickel Alloy | Nickel Alloy | |
| φ 8 × 19mm Half thread (13.0Hex) | E-EH | R847- | 10,11 | | | Nickel Alloy | — | |

※ 1 ISO: The length from gasket to terminal of ISO type spark plugs is 50.5mm which is 2.5mm shorter than BCP-E or BC-E type spark plugs.

※ 2 It's necessary to use special plug caps(please refer to page 6)

※ 3 Resistor spark plugs are recommended for cars originally equipped with resistor spark plugs.

When nonresistor spark plugs are installed in such cars, there is some possibility that the electric devices in the car, such as the audio system or the engine management system, would be affected by noise.

NOTICE) = Solid post terminal

= Thread terminal with nut

= Thread terminal

Appearance

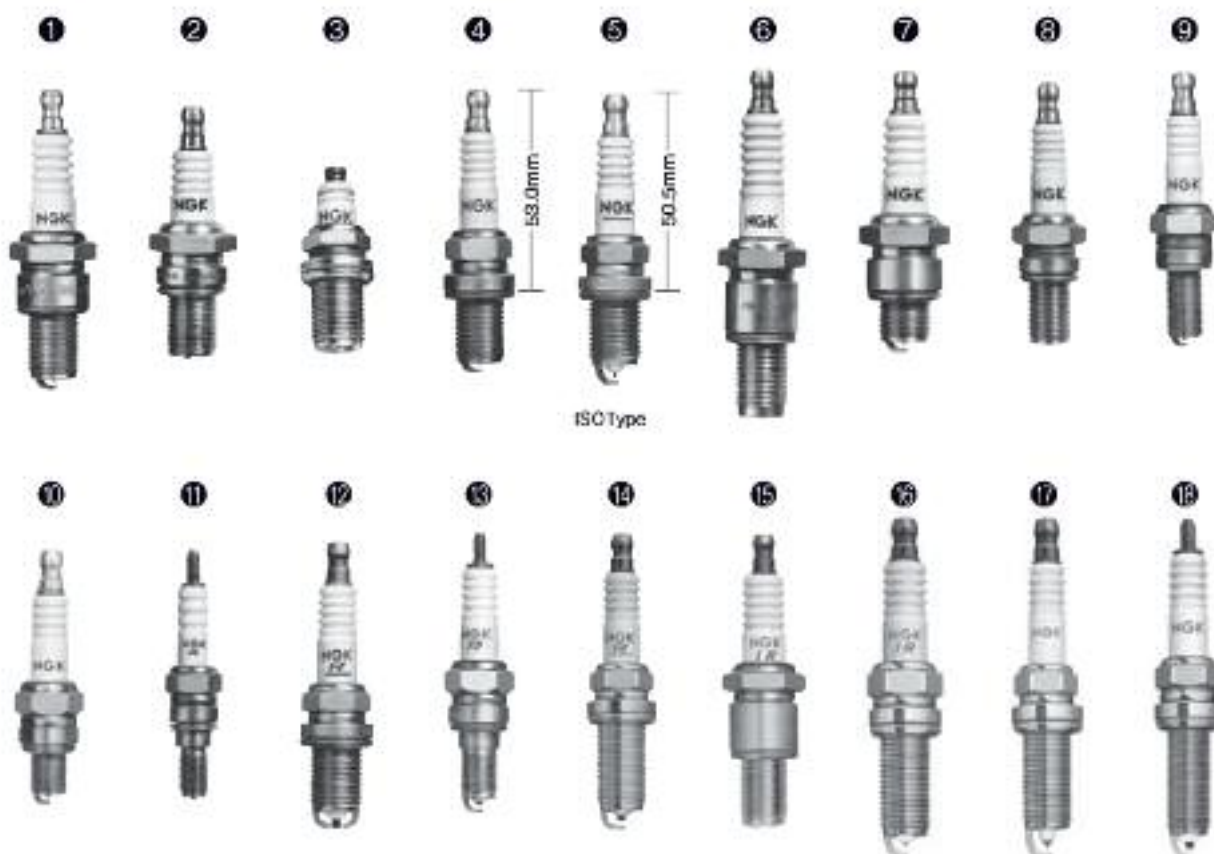

Firing end



Discontinued plug types

Note: color indicates resistor plugs.

| Old part number | New part number | Old part number | New part number |
|-----------------------|--------------------|-----------------------|--------------------|
| R016- R017- | → R0373A- | R5400- R5400F- R0337- | → R7435- |
| R216- R217- | → R2525- | R5686- | → R7435- or R7436- |
| R2270- R2430- | → R2349- | R5830- R5687- | → R7436- |
| R4630A- R6385- P | → R7376- | R7112- R7113- | → R7433- |
| R6120- | → R7282- | R7114- R7115- | → R7433- or R7434- |
| R6120A- | → R7282A- | R7116- R7117- | → R7434- |
| R6120C- | → R7282C- | R7118- R7119- | → R7434- |
| R6120M- | → R7282M- | R7232- R7233- | → R7435- |
| R8255- R6255F- R6326- | → R7433- | R7234- R7235- | → R7435- or R7436- |
| R6205- R6241- | → R7433- or R7434- | R7236- R7237- | → R7436- |
| R6206- R6242- | → R7434- | R7238- R7239- | → R7436- |

Размещение номеров двигателей

Данная информация относится только к оборудованию первичной комплектации от производителей автомобилей.

| | |
|-------------------|--|
| Alfa | типовая табличка, блок двигателя |
| Audi | в сервисном паспорте, блок двигателя, а также: A2, A3, A4, A5, A6, A8 SPARE WHEEL PAN RIGHT 100/200 замыкающая пластина сзади, на внутренней стороне слева Avant днище сзади в центре 80/90, Audi V8 внутренняя сторона полки багажника Audi Coupé багажник справа, под вкладышем углубления для груза |
| BMW | блок двигателя |
| Citroën | на блоке двигателя |
| Daihatsu | инструкция по эксплуатации, блок двигателя |
| Fiat | типовая табличка, блок двигателя |
| Ford | блок двигателя, типовая табличка |
| Honda | блок двигателя в месте перехода к коробке передач |
| Hyundai | блок двигателя в месте перехода к коробке передач |
| Jaguar | блок двигателя, типовая табличка |
| Kia | блок двигателя со стороны коробки передач |
| Lada | блок двигателя слева |
| Lancia | блок двигателя, типовая табличка |
| Mazda | блок двигателя (положение см. инструкцию по эксплуатации) |
| Mercedes | блок двигателя |
| Mitsubishi | блок двигателя, типовая табличка на капоте двигателя сервисный паспорт |
| Nissan | блок двигателя |
| Opel | блок двигателя на уровне коробки передач |
| Peugeot | блок двигателя (алюминиевая табличка) |
| Renault | блок двигателя (в центре) или алюминиевая табличка |
| Rover | блок двигателя впереди справа, на уровне головки блока цилиндров |
| Saab | блок двигателя внизу |
| Seat | блок двигателя, начиная с моделей 1993 г. - как у VW |
| Skoda | блок двигателя рядом с распределителем |
| Subaru | блок двигателя рядом с кожухом зубчатого ремня |
| Suzuki | блок двигателя в месте перехода к коробке передач F = литейный блок; G = алюминиевый блок |
| Toyota | наклейка на кожухе зубчатого ремня или на крышке клапана |
| VW | в сервисном паспорте, блок двигателя, а также Käfer: замыкающая пластина впереди слева Lupo, Polo, Derby, Golf, Scirocco, Jetta Passat Limousine, Corrado, Vento, Bora: замыкающая пластина сзади, на внутренней стороне слева Golf Cabrio: поперечина под скамьей заднего сиденья, слева Passat Variant: ниша для запасного колеса, сзади слева Transporter: поперечина блока управления слева LT: колонка, слева внизу Ittis: днище слева, рядом с „аптечкой“ Taro: задняя стенка кабины, с внутренней стороны слева |
| Volvo | серии 300, 700, 900, C, S и V: наклейка на лобовой крышке все прочие модели: наклейка на крышке клапана |

SERIES OF NGK SPARK PLUGS

NGK ZÜNDKERZENSERIEN

SÉRIES DES BOUGIES NGK

SERIES DE BUJÍAS DE ENCENDIDO NGK TYPBETECKNINGAR FÖR NGK TÄNDSTIFT

STANDARD TYPES

STANDARD AUSFÜHRUNGEN
TIPOS ESTANDARES

TYPES STANDARDS
STANDARDTYPER

|  | NON-RESISTOR NON-RÉSISTANCE ICKERESISTOR | OHNE WIDERSTAND NO-RESISTOR | RESISTOR RÉSISTANCE RESISTOR | MIT WIDERSTAND RESISTOR | |
|---|---|--------------------------------|---|--|--|
| 14mm ϕ \times 9.5mm 20.8 Hex Fig. ①① | B-2 B-4 B6S B7S B8S | | BR6S | | |
| | Fig. ①③ BP-4 BP5S BP6S | | | | |
| 14mm ϕ \times 19.0mm 20.8 Hex Fig. ②① | B4ES B5ES B6ES,-11 B7ES,-11 B8ES B9ES B10ES | | BR4ES BR5ES BR6ES,-11 BR7ES BR8ES,-11 BR9ES BR10ES | | |
| | Fig. ②② | | BR6EB-L-11 | | |
| | Fig. ②④ | | BR8EYA BR9EYA BR10EYA | | |
| | Fig. ②⑤ BP2ES, BP-2E BP4ES,-11 BP4ES-L-11 BP5ES,-11,-13 BP6ES,-11 BP7ES,-11 BP8ES BP9ES | | BP5ESZ BP6ESZ | BPR2ES, BPR-2E BPR4ES,-11,-13 BPR5ES,-11,-13 BPR6ES,-11,-13 BPR7ES,-11 BPR8ES BPR9ES | |
| | Fig. ②⑥ | | BPR5EA BPR5EA-L,-11 | | |
| | Fig. ③⑤ | | BPR6EKN BPR7EKN | | |
| | Fig. ②⑦ BP4EY,-11 BP5EY,-11 BP6EY,-11 BP7EY | | BPR4EY,-11 BPR5EY,-11 BPR6EY,-11 BPR7EY,-11 | | |
| | Fig. ②⑧ BP5E BP6E | | BPR4E,-11 BPR5E,-11 BPR6E,-11 BPR7E | | |
| | Fig. ④⑨ BP5ET,-10 BP6ET BP7ET | | | | |
| | Fig. ⑤① | | BPR5EJ | | |
| 14mm ϕ \times 19.0mm 16.0 Hex Fig. ⑥③ | BCP4ES,-11 BCP5ES,-11 BCP6ES,-11 BCP7ES,-11 | | BCPR4ES-11 BCPR5ES,-11 BCPR6ES,-11 BCPR7ES,-11 BCPR9ES-11 | | |
| | Fig. ⑧⑨ ISO BCP5ET BCP6ET BCP7ET | | BCPR5ET BCPR6ET BCPR7ET | | |
| | Fig. ⑥① BC6ES | | BCR8ES | | |
| | Fig. ⑦③ ISO BK5ES | | BK5ESZ | BKR4ES-11 BKR5ES,-11 BKR6ES,-11 BKR7ES-11 | |

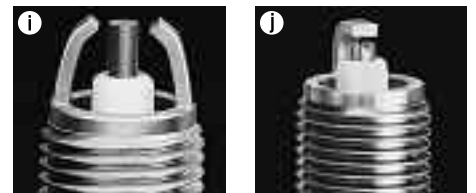
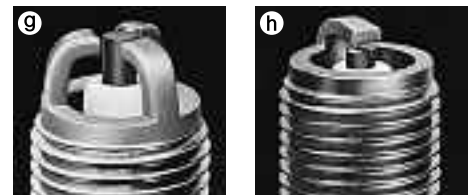
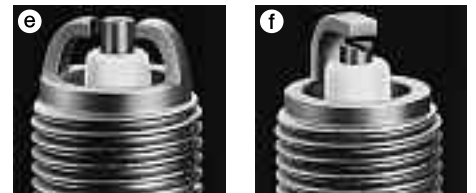
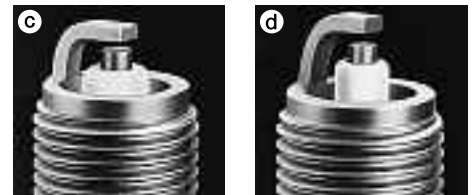
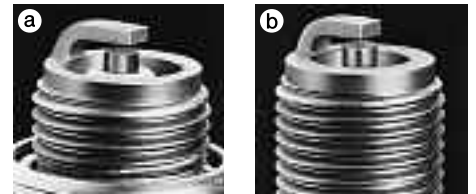
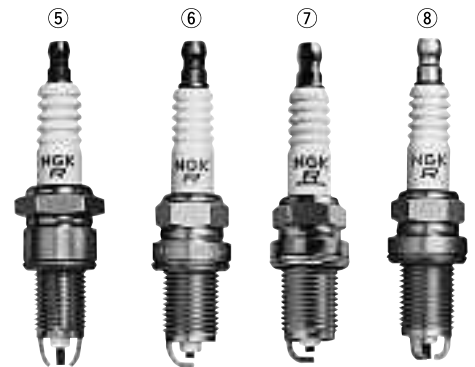
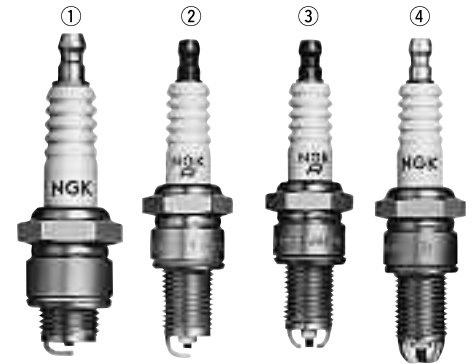

|  | NON-RESISTOR NON-RÉSISTANCE ICKERESISTOR | OHNE WIDERSTAND NO-RESISTOR | RESISTOR RÉSISTANCE RESISTOR | MIT WIDERSTAND RESISTOR |
|--|--|--------------------------------|---|----------------------------|
| 14mm ϕ \times 19.0mm 16.0 Hex Fig. ①① | BCP5EY,-11 | | BCPR4EY,-11 BCPR5EY,-11,-N-11 BCPR6EY,-11,-N-11 BCPR7EY,-11,-N-11 | |
| Fig. ②① ISO | | | BKR4EY,-11 BKR5EY,-11 BKR5EYA,-11 BKR6EY,-11 BKR6EYA,-11 BKR7EY | |
| Fig. ①② | BCP5E,-11 BCP6E,-11 BCP7E,-11 | | BCPR5E,-11 BCPR6E,-11 BCPR7E,-11 | |
| Fig. ②② ISO | BK5E,-11 BK6E,-11 | | BKR4E,-11 BKR5E,-11,-N,-N-11 BKR5EZ BKR6E,-11,-N,-N-11 BKR6EZ BKR7E,-11,-N-11 BKR8E-11 | |
| Fig. ⑥③ ISO | | | BKR5EK BKR6EK | |
| Fig. ⑥④ ISO | | | BKR5EKB,-11 BKR6EKB,-11 | |
| | | | BKR5EKC BKR6EKC,-N-11 BKR6EKE BKR7EKC,-N,-N-11 | |
| 14mm ϕ \times 26.5mm 16.0 Hex Fig. ⑧② | | | LFR4A,-11 LFR5A,-11 LFR6A,-11 | |
| 14mm ϕ \times 11.2mm Conical seat 16.0 Hex Fig. ③① | B7FS | | BR5FS BR6FS,-15 | |
| Fig. ③② | BP4FS BP5FS BP6FS BP7FS | | BPR4FS,-11,-15 BPR5FS,-11,-15 BPR6FS | |
| Fig. ③③ | BP5F BP6F | | | |
| 14mm ϕ \times 17.5mm Conical seat 16.0 Hex Fig. ④① | B6EFS B8EFS B9EFS | | BR7EFS | |
| Fig. ④② | | | BR6EF BR7EF | |
| Fig. ④③ | BP4EFS BP5EFS,-13 BP6EFS,-13 BP7EFS | | BPR5EFS,-13 BPR6EFS,-13,-15 BPR7EFS-15 | |
| Fig. ④④ | BP6EF | | BPR6EF,-11,-13 | |
| 14mm ϕ \times 25.0mm Conical seat 16.0 Hex Fig. ⑦② | | | TR5A-13 TR5B-13 TR6B-10,-13 | |
| 14mm ϕ \times 11.2mm 20.8 Hex Fig. ⑤① | B-4L B-6L B6LY(Fig. ⑤②) | | | |

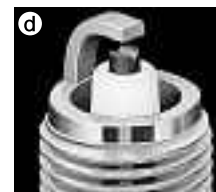
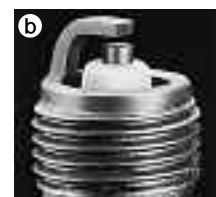
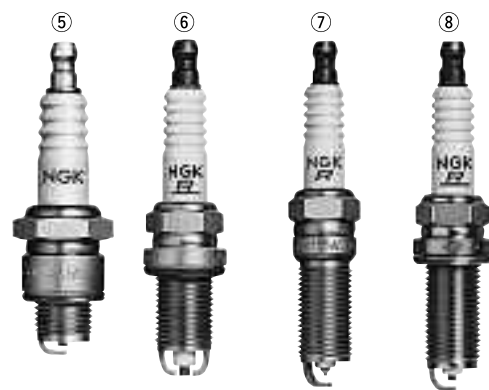
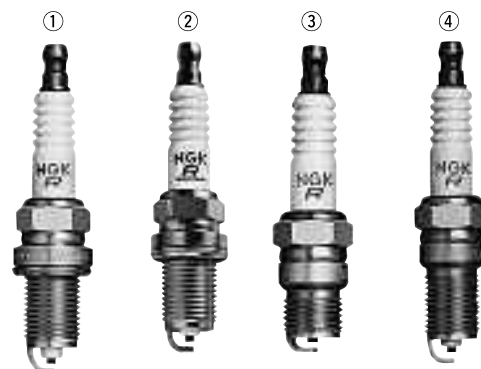

|  | NON-RESISTOR NON-RÉSISTANCE ICKERESISTOR | OHNE WIDERSTAND NO-RESISTOR | RESISTOR RÉSISTANCE RESISTOR | MIT WIDERSTAND RESISTOR |
|--|---|--|--|--|
| 14mm ϕ \times 12.7mm 20.8 Hex Fig. ①⑧ | B-2H B-4H,-10 B5HS B6HS,-10 B7HS,-10 B8HS,-10 B9HS,-10 B10HS | | BR4HS BR5HS BR6HS,-10 BR7HS,-10 BZ7HS-10 BR8HS,-10 BR9HS,-10 | |
| | Fig. ①⑨ | BP2HS,-10 BP4HS,-10 BP4HSA BP5HS,-10 BP6HS,-10 BP6HSA BP7HS,-10 BP7H BP8HS,-10,-15 BP8HSA | BP-2H BP-4H BP6H BP7H | BPR2HS BPR4HS,-10 BPR4HSA BPR-4H BPR5HS BPR6HS,-10 BPR6HSA BPR7HS,-10 BPR8HS,-10 BPR8HSA BPZ3HS-10,-15 |
| | Fig. ①⑩ | BP4HA BP5HA | | |
| | Fig. ①⑪ | B6HSA B8HSA | | BR4HSA,-9 BR6HSA,-9 BR8HSA,-9 |
| 18mm ϕ \times 10.9mm Conical seat 20.8 Hex Fig. ④⑫ | A6FS A7FS A8FS A9FS | | AR6FS | |
| | Fig. ④⑬ | AP4FS AP5FS AP6FS AP7FS AP8FS AP9FS | | APR5FS APR6FS |
| | Fig. ④⑭ | AP6F | | APR6F |
| 18mm ϕ \times 12.0mm 20.8 Hex Fig. ⑤⑮ | AB-2 AB-6 AB-7 AB-8 | | | |
| 12mm ϕ \times 19.0mm 18.0 Hex Fig. ⑥⑯ | D6EA D7EA D8EA D9EA D10EA | | DR7EA DR7EB DR8EA DR8EB DR9EA | |
| | Fig. ⑥⑰ | DP6EA-9 DP7EA-9 DP8EA-9 DP9EA-9 | | DPR5EA-9 DPR6EA-9 DPR6EB-9 DPR7EA-9 DPR8EA-9 DPR9EA-9 |
| | Fig. ⑥⑱ | J9A | | JR8B JR9B JR10B |
| | Fig. ⑥⑲ | | | JR8C JR9C |
| 12mm ϕ \times 21.0mm 18.0 Hex Fig. ⑦⑳ | DP8Z | | DPR7Z DPR8Z DPR9Z | |
| 12mm ϕ \times 19.0mm 16.0 Hex Fig. ⑧㉑ | DCP6E DCP7E | | DCPR6E DCPR7E DCPR7E-N DCPR8E DCPR8E-N DCPR9E | |
| | Fig. ⑧㉒ | | | DCPR8EKC |
| 12mm ϕ \times 26.5mm 14.0 Hex | | | LKAR8A-9,9S | |

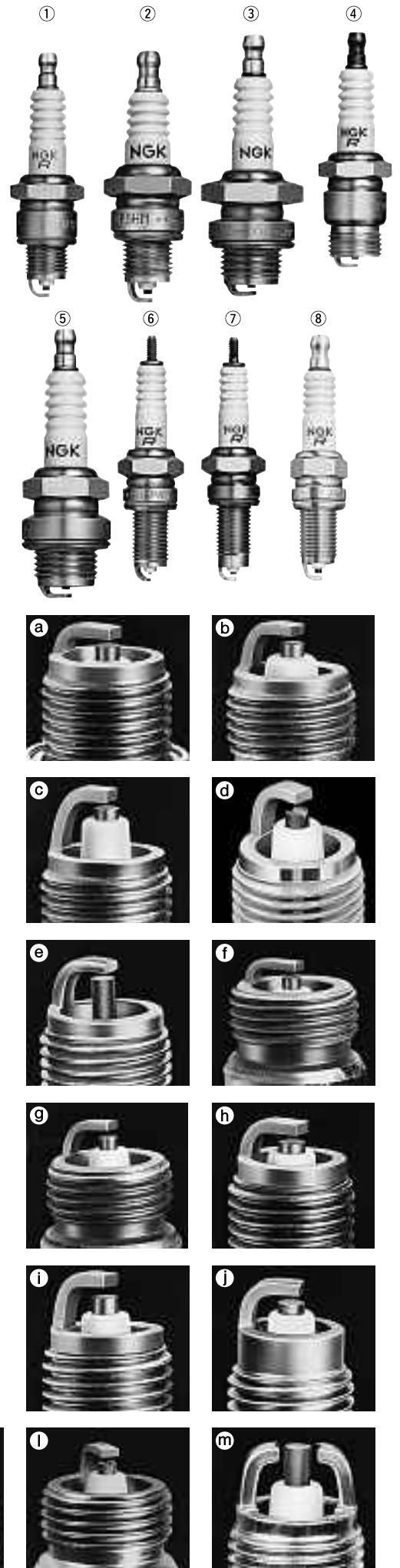

|  | NON-RESISTOR OHNE WIDERSTAND NON-RÉSISTANCE NO-RESISTOR ICKERESISTOR | RESISTOR MIT WIDERSTAND RÉSISTANCE RESISTOR RESISTOR | |
|---|--|---|---|
| 12mm ϕ \times 12.7mm 18.0 Hex Fig. ①② | D6HA D8HA | DR4HS DR5HS DR6HS DR8HS | |
| 10mm ϕ \times 12.7mm 16.0 Hex Fig. ②③ | C2H C5HSA C6HSA C7HSA C8HSA | C4HSB C5HSB CR4HSA CR5HSA CR6HSA CR7HSA CR8HSA | CR4HSB CR5HSB LR8A |
| 10mm ϕ \times 19.0mm 16.0 Hex Fig. ③④ | C7E C8E C9E | CR6E CR7E CR8E CR9E CR10E | CR7EB CR8EB CR9EB |
| Fig. ③⑤ | | CPR8E | CPR7EA-9 |
| 10mm ϕ \times 19.0mm 16.0 Hex Fig. ④⑥ | C7EH-9 C8EH-9 C9EH-9 | CR7EH-9 CR8EH-9 CR9EH-9 CR10EH-9 | |
| 10mm ϕ \times 19.0mm 16.0 Hex Fig. ③⑦ | | CR7EK CR8EK CR9EK CR10EK | CR7EKB CR8EKB CR9EKB |
| Fig. ③⑧ | | CR7EKC | |
| 10mm ϕ \times 19.0mm 14.0 Hex | | MAR10A-J | |
| 10mm ϕ \times 26.5mm 14.0 Hex | | LMAR6A-9 LMAR7A-9 LMAR8A-9,9S | LMAR6C-9 |
| 8mm ϕ \times 19.0mm 13.0 Hex Fig. ⑤⑨ | | ER8EH ER9EH ER10EH | |



FOR ROTARY ENGINE
FÜR WANKELMOTOR **POUR MOTEUR ROTATIF**
PARA MOTOR ROTATIVO **TÄNDSTIFT FÜR WANKELMOTORER**

|  | NON-RESISTOR OHNE WIDERSTAND NON-RÉSISTANCE NO-RESISTOR ICKERESISTOR | RESISTOR MIT WIDERSTAND RÉSISTANCE RESISTOR RESISTOR | |
|---|--|--|----------------------------------|
| 14mm ϕ \times 19.5mm 20.8 Hex Fig. ⑥⑩ | B7EM | BR8EM | |
| Fig. ⑥⑪ | | BR7ET BR8ET BR9ET BR10ET | |
| Fig. ⑥⑫ | | BR7EQ-14 BR8EQ,-14 BR9EQ-14 | |
| 14mm ϕ \times 21.5mm 20.8 Hex Fig. ⑧⑬ | | SD10A SD11A | |
| Fig. ⑧⑭ | | BUR6EQ BUR7EQ BUR8EQ BUR9EQ | BUR7EQP BUR9EQP |
| 14mm ϕ \times 21.0mm 20.8 Hex Fig. ⑨ | | RE6C-L RE7C-L RE8C-L | |
| 14mm ϕ \times 19.0mm 20.8 Hex Fig. ⑩⑮ | | RE9B-T | |

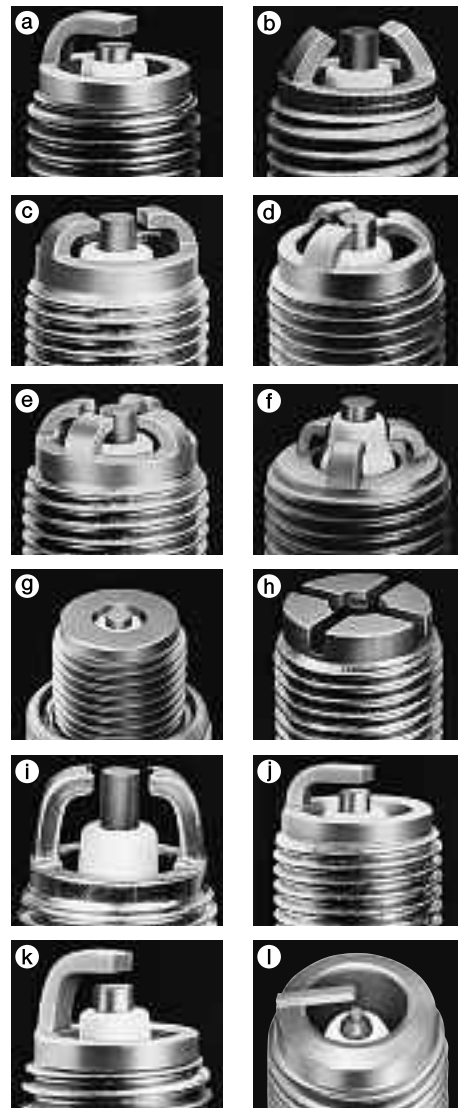

SEMI SURFACE DISCHARGE TYPES
HALBGLEITFUNKENTYP TYPE À DÉCHARGE
TIPO DE DESCARGA DE MEDIA SUPERFICIE
STIFT MED YTGNIISTGAP

|  | NON-RESISTOR OHNE WIDERSTAND NON-RÉSISTANCE NO-RESISTOR ICKERESISTOR | RESISTOR MIT WIDERSTAND RÉSISTANCE RESISTOR RESISTOR |
|---|--|---|
| 14mm ϕ \times 12.7mm 20.8 Hex Fig. ①a | BU8H | BUZ8H |
| 14mm ϕ \times 19.0mm 20.8 Hex Fig. ②b | BU6EA-11 | BUR5EA-11 BUR6EA-11 BUR7EA-11 |
| 14mm ϕ \times 19.0mm 20.8 Hex Fig. ②c | | BUR4EB-11 BUR5EB-11 BUR6EB-11 BUR7EB-11 |
| Fig. ②d | | BUR5ET,-10 BUR6ET |
| 14mm ϕ \times 19.0mm 20.8 Hex Fig. ③e | BP5EK-A BP6EK-A | BPR5EK-A BPR6EK-A |
| Fig. ③f | | BPR5EKU |
| 14mm ϕ \times 17.5mm Conical seat 16.0 Hex Fig. ④g | BU6EFSZ | BUR6EFSZ |
| 14mm ϕ \times 19.0mm 16.0 Hex Fig. ⑥e ISO | | BKUR6EK,-9 BKUR7EK |
| Fig. ⑤d ISO | | BKUR5ET,-10 BKUR5ETZ-10 BKUR6ET,-10 BKUR6ETB BKUR7ET |
| Fig. ⑥f ISO | BK7EKU | BKR5EKU BKR6EKU BKR7EKU |
| Fig. ⑥h ISO | | BKR6EKUE |
| | | BKR6EKUB |
| 14mm ϕ \times 22.0mm 16.0 Hex Fig. ⑦i | | BKR5EKUC BKR6EKUC |
| 14mm ϕ \times 19.0mm 16.0 Hex Fig. ⑥j | | BKR6EQUA |

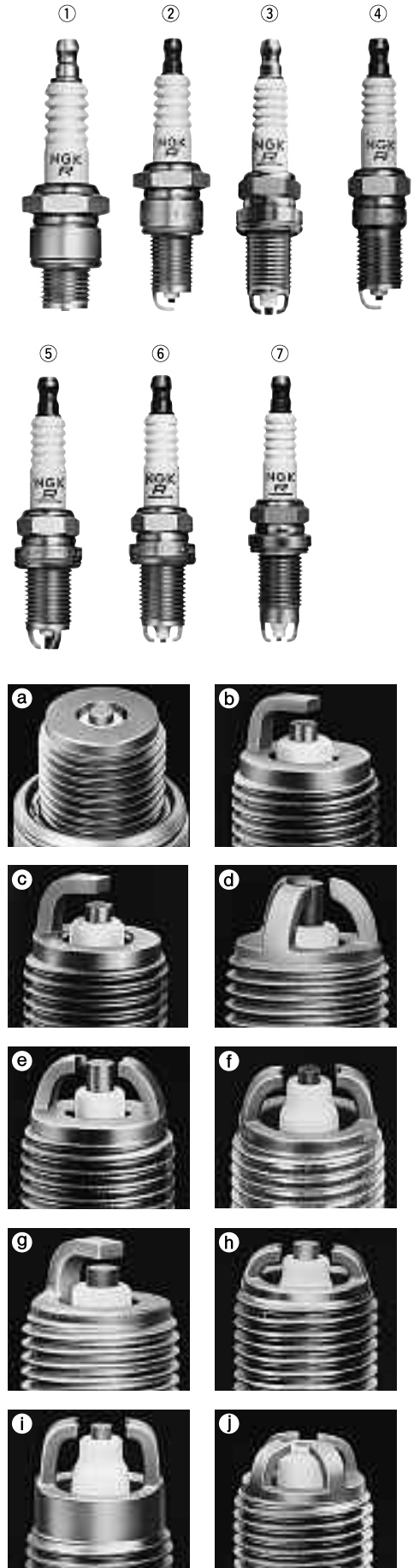

PROJECTED GAP TYPES
ZUNDKERZEN MIT VORSRINGENDER FUNKENSTRECK
TYPE A ÉCARTEMENT EN SAILLIE
TIPOS DE ABERTURA DE CHISPA PROYECTADA
STIFT MED FÖRLÅNGDA ELEKTRODER

|  | NON-RESISTOR NON-RÉSISTANCE ICKERESISTOR | OHNE WIDERSTAND NO-RESISTOR | RESISTOR RÉSISTANCE RESISTOR | MIT WIDERSTAND RESISTOR |
|---|--|--------------------------------|--|------------------------------|
| 14mm ϕ \times 19.0mm 20.8 Hex Fig. ①(a) Fig. ②(b) | BE527Y-11 BE529Y-11 | | BRE527Y-11 BRE529Y-11 | ZGR4A ZGR5A |
| 14mm ϕ \times 26.0mm 20.8 Hex Fig. ②(d) | ZG5D-11 | | | |
| 14mm ϕ \times 20.5mm 20.8 Hex Fig. ②(b) | | | ZGR5B,-11 ZGR6B-11 | |
| 14mm ϕ \times 22.0mm 20.8 Hex Fig. ②(c) | | | ZGR5C | |
| 14mm ϕ \times 19.0mm 16.0 Hex Fig. ③(b) | ZF6A-11 | | ZFR5A-11 ZFR6A-11 | |
| Fig. ④(b) ISO | | | ZFR4F-11 ZFR5F,-11 ZFR6F-11,G ZFR7F,-11 | |
| Fig. ④(b) ISO | | | ZFR5J-11 ZFR6J-11 ZFR7J-11 | |
| Fig. ③(a) | | | BCRE527Y | |
| 14mm ϕ \times 20.5mm 16.0 Hex Fig. ③(e) | | | ZFR6K-11S | |
| | | | ZFR5G ZFR6G | |
| 14mm ϕ \times 22.5mm 16.0 Hex Fig. ③(c) | | | ZFR4E-11 ZFR5E-11 ZFR6E-11 | |
| Fig. ③(d) | | | ZFR5D-11 ZFR6D-11 | |
| 14mm ϕ \times 25.0mm Conical seat 16.0 Hex Fig. ⑤(b) | | | LZTR4A-11 LZTR5A-13 | |

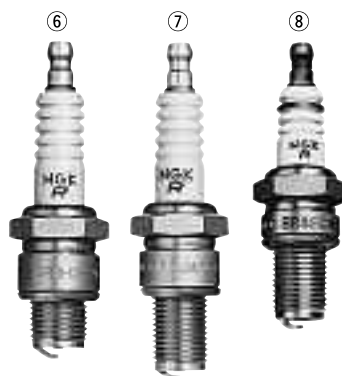
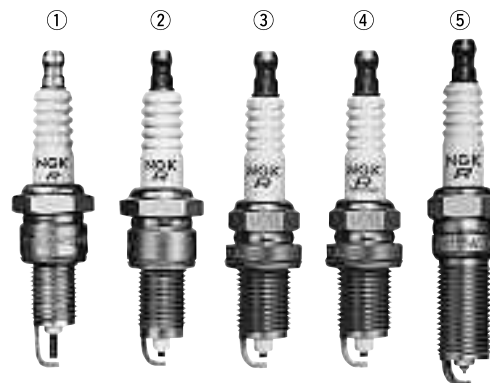

COMPETITION TYPES
WETTBEWERBS-TYPEN **TYPES COMPÉTITION**
TIPOS DE COMPETICIÓN **RACERSTIFT**

| | | |
|--|--|--|
| 14mm ϕ \times 12.7mm 20.8 Hex Fig. ⑥(f) | B7HCS B8HCS B9HCS | BR8HCS-10 |
| 14mm ϕ \times 19.0mm 20.8 Hex Fig. ⑦(f) | B7ECS B8ECS B9ECS | BR8ECS BR9ECS BR10ECS |
| Fig. ⑧(f) | | BR8ECM BR9ECM BR10ECM |

PLATINUM, IRIIDIUM TIPPED TYPES
TYPEN MIT PLATINELEKTRODENSPITZE, IRIIDIUMSPITZE
TYPE[S] À EXTREMITÉ EN PLATINE, IRIIDIUM
TIPOS CON PUNTA DE PLATINO, IRIIDIUM
STIFT MED MITTELEKTRODÄNDA AV PLATINA OCH IRIIDIUM

| | |
|---|--|
|  | RESISTOR MIT WIDERSTAND RÉSISTANCE RESISTOR RESISTOR |
| 14mm ϕ \times 19.0mm 20.8 Hex Fig.①① | PGR5A,-11 PGR5C-11 BPR5EP-11,-13 PGR6A,-11 PGR6C-11 BPR6EP-8 PGR7A,-11 IGR7A |
| 14mm ϕ \times 19.0mm 20.8 Hex Fig.①h | IGR5C13 |
| 14mm ϕ \times 19.0mm 16.0 Hex Fig.②a | PFR5A-11 PFR5K-11 BCPR5EP-8,-11,-13 PFR6A-11 PFR6H-10 PFR6K-11 BCPR6EP-8,N-8,-11,-N-11,-13 PFR7A-11 PFR7H-10 |
| Fig.③h ISO | FR4AP-10,-11 FR4BP-11 FR5AP-10,-11 FR5BP-11 FR5AP-11E FR6AP-10,-11 FR6BP-11 FR7AP-11 FR5EI-13 PFR4B-11 PFR4C-11 PFR5B,-9,-11,-11B PFR5C-11 PFR6B,-9,-11,-11B,-11C PFR6C-11 PFR6E-10 PFR7B,-9,-11,-11C PFR8B,-9 PFR4G-11 PFR5G-11,-13E PFR5J-11 PFR6G,-9,-11,-13,-13E PFR6H-10 PFR6J,-11 PFR7G,-9,-11 PFR5L-11 PFR5N-11 PFR4P PFR6L-11,-13 PFR6N-11 PFR5P,-11 PFR7N-D PFR6P,-11 PFR6Q PFR7Q PFR5R-11 BKR5EP-8,-11 BKR6EP-8,-11,-13,-N-8 |
| Fig.④c ISO | BKR6EKPA |
| Fig.④d ISO | BKR5EKUP |
| Fig.④e ISO | BKR5EKPB-11,-13 BKR6EKPB-11 |
| Fig.④j ISO | BKR5EQUPA BKR6EQUP BKR6EQUPA |
| Fig.③f ISO | PFR6M PFR7M |
| Fig.③g ISO | PZFR5B PZFR5F,-11,-13 PZFR6B PZFR6F,-11 PZFR7F |
| Fig.③h ISO | IFR5A11,-8N IFR5D10 IFR5E11 IFR6A11 IFR6C IFR6D10 IFR6E11 IFR5G11 IFR5J11 IFR5N10 IFR6S IFR5T-8N,11 IFR6J11 IFR6T11 IFR7F-D |
| Fig.②g | IZFR5B IZFR5F11 IZFR6B IZFR6F11 ZFR5LP-13G |
| 14mm ϕ \times 22.0mm 16.0 Hex Fig.⑩k | PZFR5C PZFR5D-11 |
| Fig.⑩k ISO | IZFR5C IZFR7E-D |
| 14mm ϕ \times 25.0mm conical seat 16.0 Hex Fig.⑥h | PTR5A-13 |



| | |
|---|---|
|  | RESISTOR MIT WIDERSTAND RÉSISTANCE RESISTOR RESISTOR |
| 14mm ϕ \times 17.5mm conical seat 16.0 Hex Fig. (9) (i) | PTR4B-15 PTR5C-13,-15 ITR4A15 ITR5F13 ITR6F13 |
| 14mm ϕ \times 17.5mm conical seat 16.0 Hex Fig. (3) (h) | PTR5D-10,-13 PTR6D-13,-13G |
| Fig. (9) (g) | PZTR5A-15 |
| 14mm ϕ \times 20.5mm 16.0 Hex Fig. (3) (a) | IZFR6K11,11E,13 IZFR6K-11S,IZFR6K11NS |
| 14mm ϕ \times 21.5mm 16.0 Hex Fig. (m) | PZFR5N-11T |
| 14mm ϕ \times 22.0mm 16.0 Hex Fig. | PZFR6J-11 |
| 14mm ϕ \times 26.5mm 16.0 Hex Fig. (11) (a) | PLFR4A-11 PLFR5A-9,-11 PLFR6A-9,-11 PLFR7A-9 |
| Fig. (11) (g) | ILZFR6A11 |
| 14mm ϕ \times 29.5mm 16.0 Hex Fig. (11) (j) | LZFR5AQP |
| 14mm ϕ \times 25.0mm conical seat 16.0 Hex | PLZTR4A-13,PLZTR5A-13 |
| 12mm ϕ \times 19.0mm 18.0 Hex Fig. (5) (h) | PJR6A PJR7A PJR8A |
| | IJR7A9 |
| 12mm ϕ \times 19.0mm 16.0 Hex Fig. (7) (i) | PKR7A PKR9B |
| 12mm ϕ \times 19.0mm 16.0 Hex Fig. (7) (c) | DCPR8EKP |
| 12mm ϕ \times 22.0mm 16.0 Hex Fig. | IZKR7A |
| 12mm ϕ \times 28.0mm 16.0 Hex | ILZKR7B11 ILZKR7B-11S ILZKR7B11GS |
| 10mm ϕ \times 19.0mm 16.0 Hex Fig. (8) (i) | PMR7A PMR8A PMR8B |
| 10mm ϕ \times 19.0mm 16.0 Hex Fig. (12) | IMR9C-9H IMR9C-9HE,IMR9C-9HES |
| 12mm ϕ \times 26.5mm Bi-Hex 14.0mm | ILZKBR7A-8G PLZKBR7A-G |

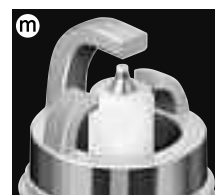
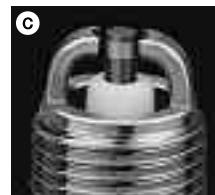

COMPACT TYPES

KOMPAKT STIFT
TIPOS COMPACTOS

TYPES CMPACTES
KOMPACTE TYPEN

|  | NON-RESISTOR NON-RÉSISTANCE ICKERESISTOR | OHNE WIDERSTAND NO-RESISTOR | RESISTOR RÉSISTANCE RESISTOR | MIT WIDERSTAND RESISTOR |
|---|--|--|--|---|
| 14mm ϕ \times 9.5mm 19.0 Hex Fig. ①(a) | BM4A BM6A BM7A | B2-LM* B4-LM* BM6* BM7* *Hex.20.8mm | BMR2A,-10 BMR4A BMR6A BMR7A | BR2-LM* BR4-LM* *Hex.20.8mm |
| Fig. ①(b) | BPM4A,-10 BPM6A,-10 BPM7A | | BPMR4A,-10 BPMR6A,-10 BPMR7A,-9 | |
| 14mm ϕ \times 12.7mm 20.8 Hex Fig. ②(a) | BL-6H | | | |
| 14mm ϕ \times 7.8mm Conical seat 16.0 Hex Fig. ③(a) | BM6F BM7F | BM6FY | BMR6F | |
| Fig. ③(b) | BPM6F BPM7F | | BPMR6F | |
| 10mm ϕ \times 8.6mm 14.0 Hex Fig. ④(a) | CM-6 | | | |
| 10mm ϕ \times 9.5mm 16.0 Hex Fig. ⑧(a) | | | CMR6A CMR7A | |
| 10mm ϕ \times 12.7mm 16.0 Hex Fig. ⑧(e) | | | CMR5H CMR6H CMR7H | |
| 14mm ϕ \times 9.5mm 19.0 Hex Fig. ①(c) | BPM6Y BPM7Y BPM8Y | | BPMR6Y BPMR8Y | |

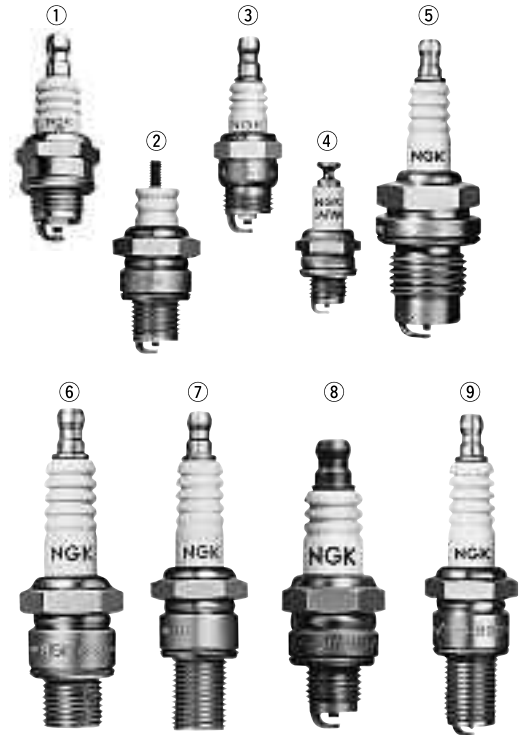

FARM EQUIPMENT TYPES

LANDMASCHINEN TYPEN
TIPOS MÁQUINAS AGRÍCOLAS

TYPES MACHINES AGRICOLES
FÖR JORDBRUKS-MASKINER

| | |
|---|----------------------------|
| PF1/2" \times 22.5mm 23.8 Hex Fig. ⑤(d) | G-27 G-2Z |
|---|----------------------------|

SURFACE DISCHARGE TYPES

GLEITFUNKENTYPEN

TYPE À DÉCHARGE SUPERFICIELLE

TIPO DESCARGA EN SUPERFICIE TÅNDSTIFT MED YTGNIKTGAP

| | | |
|--|---|--------------------------------|
| 14mm ϕ \times 12.7mm 20.8 Hex Fig. ⑥(f) | BUHX(Series gap) BUHXW-1(Series gap) | |
| | BUH | |
| | BUHW BUHW-2 | BUZHW BUZHW-2 |
| 14mm ϕ \times 19.0mm 20.8 Hex Fig. ⑦(f) | BUE | |

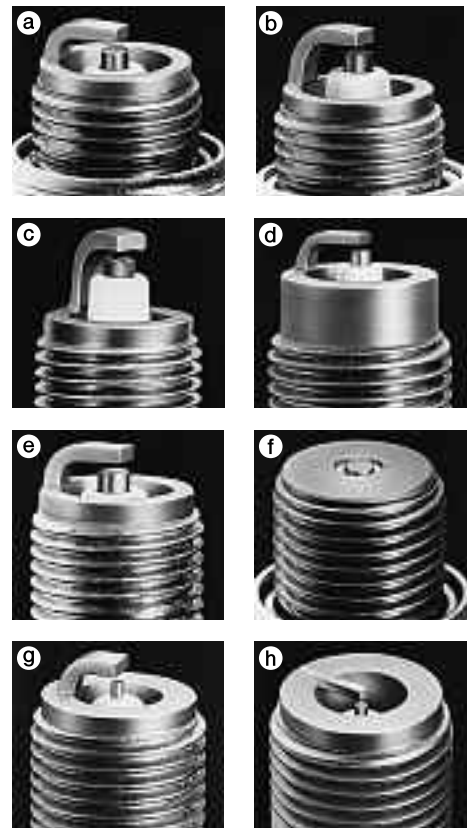

RACING TYPES

RENN-TYPEN

TYPES COURS

TIPOS DE CARRERAS

RACERSTIFT

|  | Nickel electrode Nickel Elektrode Electrodo de nickel Electrodo de níquel Nickel elektrod | Precious metal electrode Elektrode mit sonde-redel metall Electrode en metal precieux Electrodo de metal precioso Adelmetall elektrod | Platinum electrode Platinel Ektrode Electrode de platine Electrodo de platino Platina elektrod |
|---|--|---|--|
| 14mm ϕ \times 19.0mm 20.8 Hex | B8EG Fig. ⑨(g) BR8EG* B9EG BR9EG* B10EG BR10EG* B11EG | B8EGV Fig. ⑨(9) B85EGV B9EGV B95EGV B10EGV B105EGV B11EGV | B8EGP Fig. ⑨(h) B85EGP B9EGP B95EGP B10EGP |

*Resistor Type

IX TYPES

IX TYPEN
TIPOS IX

TYPES IX
IX-STIFT

| | | |
|---|--|--|
|  | RESISTOR RÉSISTANCE RESISTOR | MIT WIDERSTAND RESISTOR |
| 18mm ϕ \times 10.9mm 20.8 Hex Fig. ①(a) | WR5IX | |
| 14mm ϕ \times 19.0mm 20.8 Hex Fig. ②(b) | BPR5EIX, -11 GR4IX BPR6EIX, -11 GR5IX BPR7EIX BPR8EIX BPR9EIX | |
| | Fig. ②(c) | BR7EIX BR8EIX BR9EIX BR10EIX |
| | Fig. ②(d) | BR8ECSIX BR9ECSIX, -5 |
| | Fig. ③(d) | BR8ECMIX BR9ECMIX BR10ECMIX |
| 14mm ϕ \times 12.7mm 20.8 Hex Fig. ④(b) | BPR6HIX BPR7HIX BPR8HIX | |
| | Fig. ④(c) | BR6HIX BR7HIX BR8HIX BR9HIX BR10HIX |
| 14mm ϕ \times 9.5mm 20.8 Hex Fig. ⑤(a) | XR4IX XR5IX XR45IX | |
| 14mm ϕ \times 19.0mm 16.0 Hex Fig. ⑥(b) | BCPR7EDIX | |
| | Fig. ⑦(b) | BCPR5EIX, -11 BCPR6EIX, -11 BCPR7EIX, -11 |
| | Fig. ⑧(b) | BKR4EIX BKR5EIX, -11 BKR6EIX, -11 BKR7EIX, -11 BKR8EIX BKR9EIX |
| Fig. ⑧(e) | ZFR5FIX-11 ZFR6FIX-11 | |
| 14mm ϕ \times 26.5mm 16.0 Hex Fig. ⑨(b) | LFR5AIX-11 LFR6AIX-11 LFR7AIX | |
| 14mm ϕ \times 17.5mm Conical seat 16.0 Hex Fig. ⑩(b) | BPR6EFIX-10, -15 | |
| | Fig. ⑩(a) | TR4IX TR55IX TR5IX TR65IX TR6IX TR75IX TR7IX TR85IX TR8IX TR85IX |
| 14mm ϕ \times 20.5mm Conical seat 16.0 Hex Fig. ⑪(e) | TR5-1IX TR45-1IX TR55-1IX | |
| 14mm ϕ \times 11.2mm Conical seat 16.0 Hex Fig. ⑫(c) | YR5IX YR55IX | |
| | Fig. ⑫(a) | BR6FIX UR4IX UR45IX UR5IX UR55IX UR6IX |
| 14mm ϕ \times 25.0mm Conical seat 16.0Hex Fig. ⑬(b) | LTR5IX-11 LTR6IX-11 LTR7IX-11 | |
| | Fig. ⑬(e) | LZTR4AIX-11 LZTR5AIX-13 LZTR6AIX-13 LZTR7AIX-13 |

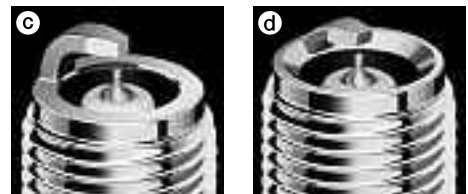
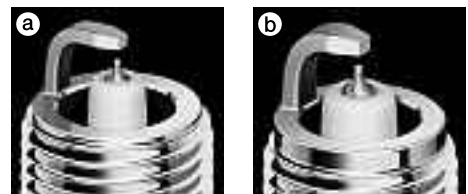

IX TYPES

IX TYPEN TYPES IX
 TIPOS IX IX-STIFT

| | |
|---|---|
|  | RESISTOR MIT WIDERSTAND RÉSISTANCE RESISTOR RESISTOR |
| 12mm ϕ \times 19.0mm 16.0 Hex Fig. ①(a) | DCPR6EIX DCPR7EIX DCPR8EIX DCPR9EIX |
| Fig. ①(b) | DCR7EIX DCR8EIX DCR9EIX |
| 12mm ϕ \times 19.0mm 18.0 Hex Fig. ②(a) | DPR7EIX-9 DPR8EIX-9 DPR9EIX-9 |
| Fig. ②(b) | DR7EIX DR8EIX DR9EIX |
| 12mm ϕ \times 21.0mm 18.0 Hex Fig. ③(a) | DPR8ZIX |
| 12mm ϕ \times 26.5mm Conical seat 14.0 Hex Fig. ④(d) | ZNAR7AIX ZNAR6AIX-11 |
| 10mm ϕ \times 19.0mm 16.0 Hex Fig. ⑤(a) | CPR7EAIX-9 |
| Fig. ⑤(c) | CR7EIX CR8EIX CR9EIX CR10EIX |
| Fig. ⑥(b) | CR8EHIX-9 CR9EHIX-9 |
| 10mm ϕ \times 12.7mm 16.0 Hex Fig. ⑦(b) | CR5HIX CR6HIX CR7HIX CR8HIX CR9HIX |
| 8mm ϕ \times 19.0mm 13.0 Hex Fig. ⑧(e) | ER8EHIX ER9EHIX |

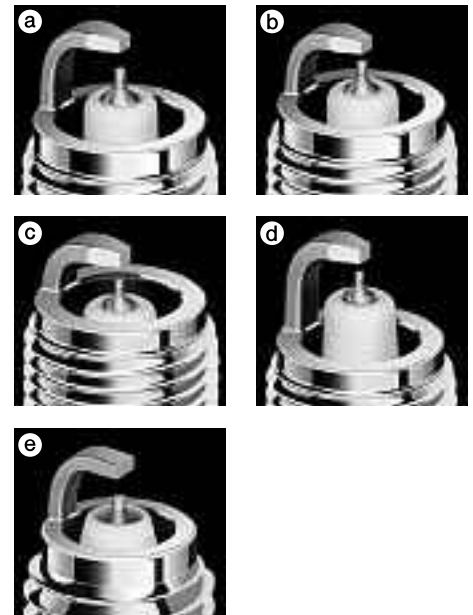

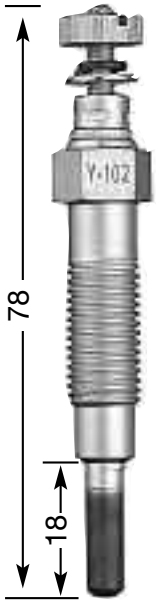

Y-102

M 10 x 1.25
12 Hex
10,5 V

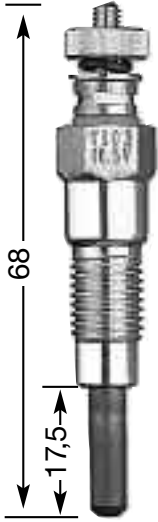

Y-103

M 10 x 1.25
12 Hex
10,5 V

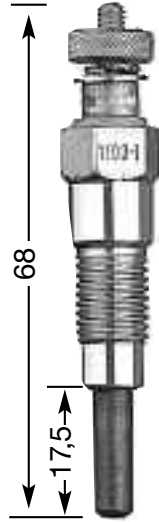

Y-103-1

M 10 x 1.25
12 Hex

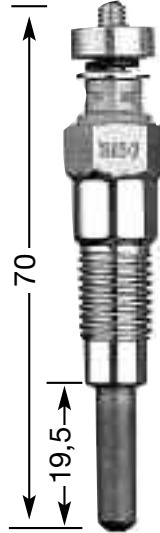

Y-103-2

M 10 x 1.25
12 Hex

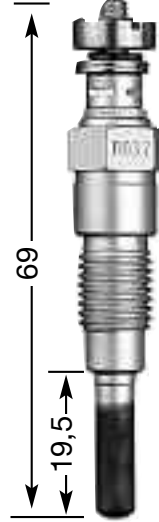

Y-103-2A

M 10 x 1.25
12 Hex

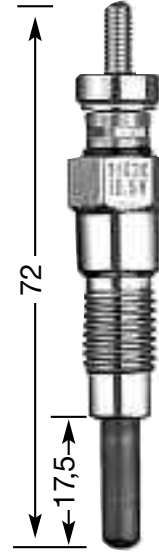

Y-103 K

M 10 x 1.25
12 Hex
10,5 V

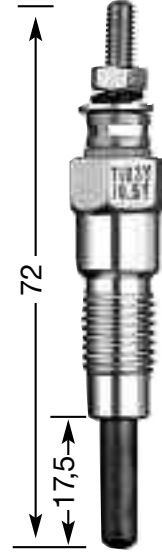

Y-103 V

M 10 x 1.25
12 Hex
10,5 V

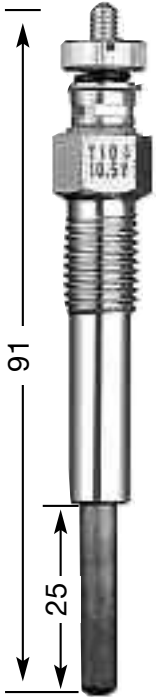

Y-104

M 10 x 1.25
12 Hex
10,5 V

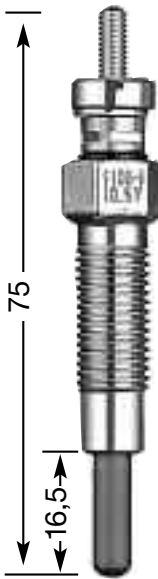

Y-106-1

M 10 x 1.25
12 Hex
10,5 V

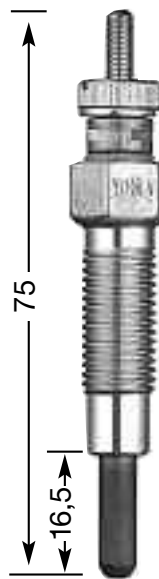

Y-106 V

M 10 x 1.25
12 Hex
10,5 V

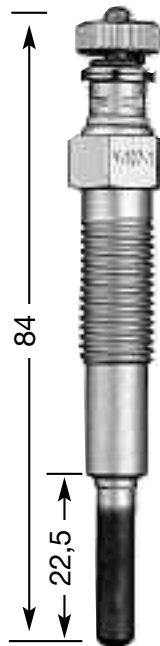

Y-107-1

M 10 x 1.25
12 Hex
10,5 V

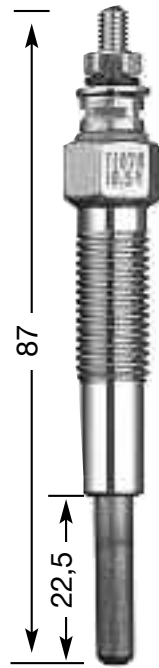

Y-107 R

M 10 x 1.25
12 Hex
10,5 V

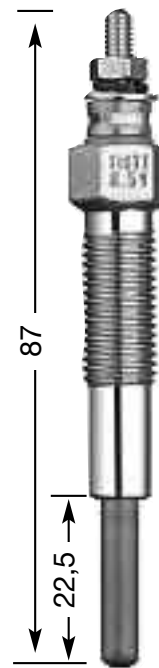

Y-107 T

M 10 x 1.25
12 Hex
8,5 V

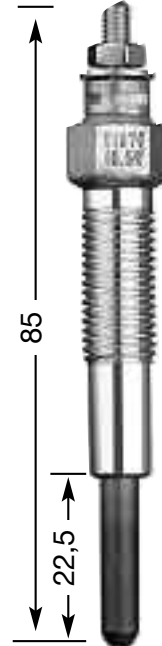

Y-107 V

M 10 x 1.25
12 Hex
10,5 V

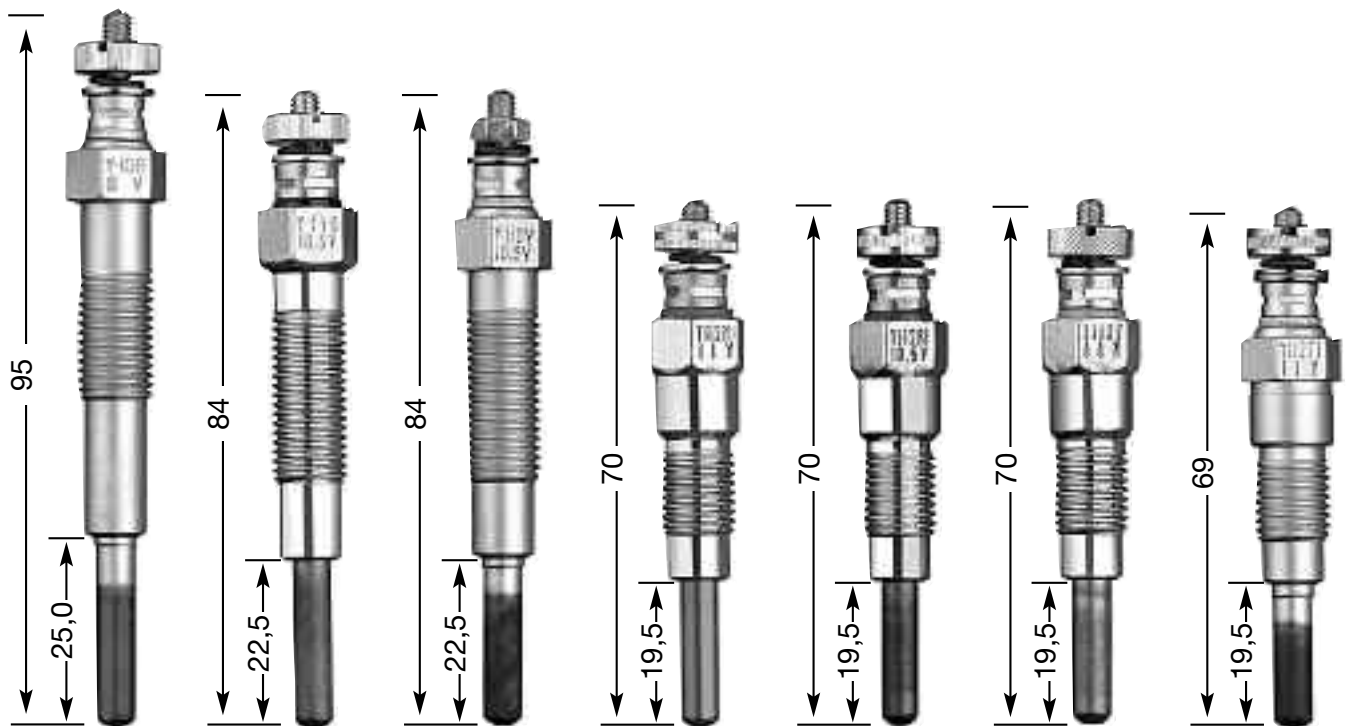

Y-108

M 10 x 1.25
12 Hex
8 V

Y-110

M 10 x 1.25
12 Hex
10,5 V

Y-110 V

M 10 x 1.25
12 Hex
10,5 V

Y-112 M1

M 10 x 1.25
12 Hex
11 V

Y-112 R1

M 10 x 1.25
12 Hex
10,5 V

Y-112 T

M 10 x 1.25
12 Hex
11 V

Y-112 T1

M 10 x 1.25
12 Hex
11 V

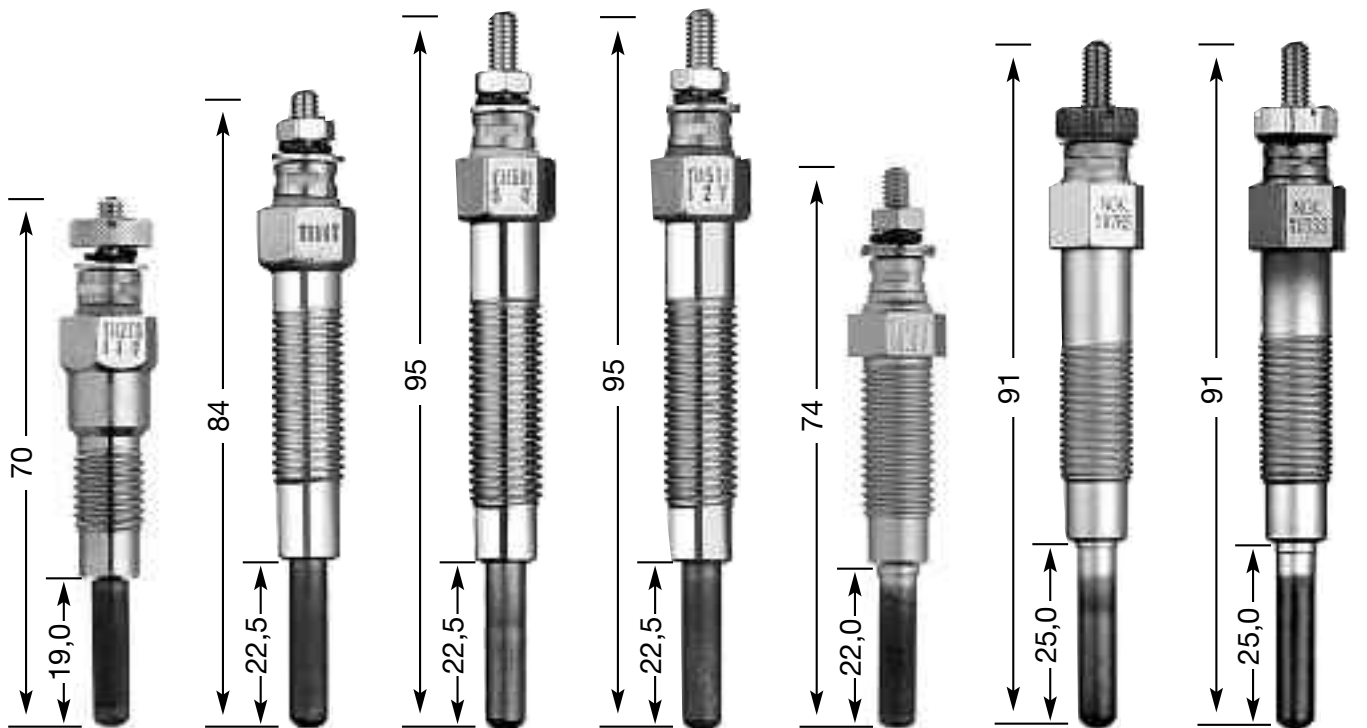

Y-112 TS

M 10 x 1.25
12 Hex
11 V

Y-114 T

M 10 x 1.25
12 Hex
10,5 V

Y-115 R1

M 10 x 1.25
12 Hex
6 V

Y-115 T1

M 10 x 1.25
12 Hex
12 V

Y-116 V

M 10 x 1.25
12 Hex
10,5 V

Y-117 RS

M 10 x 1
12 Hex
6,5 V

Y-117 SS

M 10 x 1
12 Hex
8,5 V

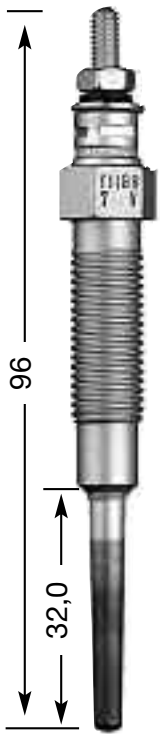

Y-118 R
M 10 x 1.25
12 Hex
7 V



Y-118 T1
M 10 x 1.25
12 Hex
11 V



Y-119 V
M 10 x 1.25
12 Hex
10,5 V

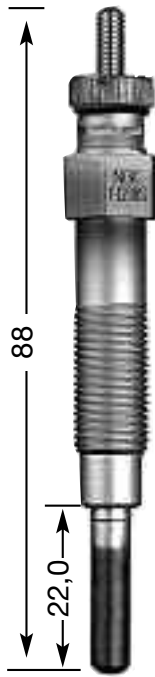

Y-120 RS
M 10 x 1.0
12 Hex
6,5 V

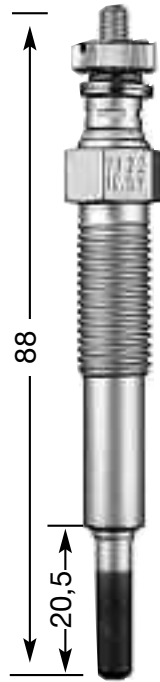

Y-122
M 10 x 1.25
12 Hex
10,5 V

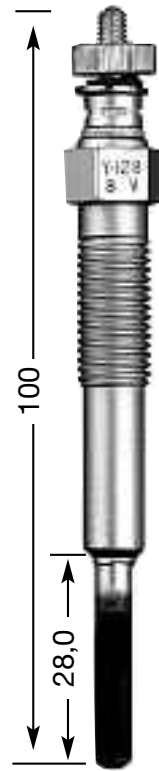

Y-128
M 10 x 1.25
12 Hex
8 V

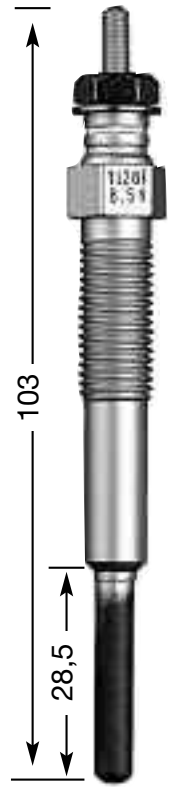

Y-128 T
M 10 x 1.25
12 Hex
8,5 V



Y-142 T
M 10 x 1.25
12 Hex

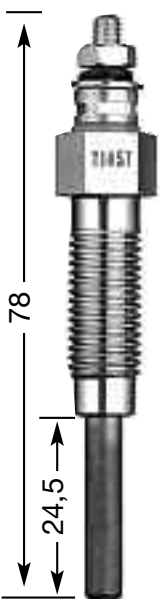

Y-145 T
M 10 x 1.25
12 Hex
10,5 V

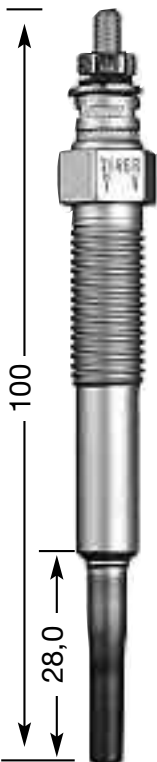

Y-146 R
M 10 x 1.25
12 Hex
7 V

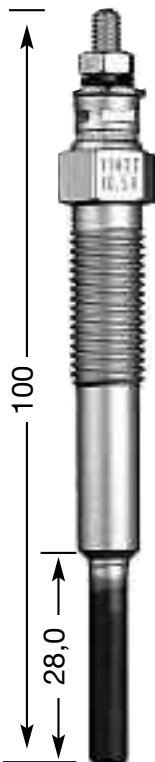

Y-147 T
M 10 x 1.25
12 Hex
10,5 V

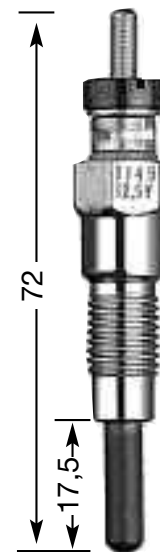

Y-149
M 10 x 1.25
12 Hex
12,5 V

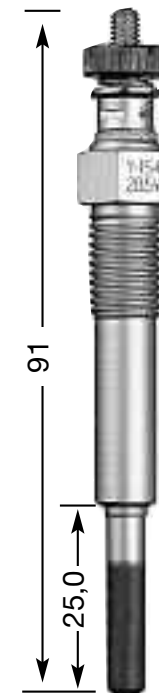

Y-154
M 10 x 1.25
12 Hex
20,5 V



Y-157 R
M 10 x 1.25
12 Hex
23 V

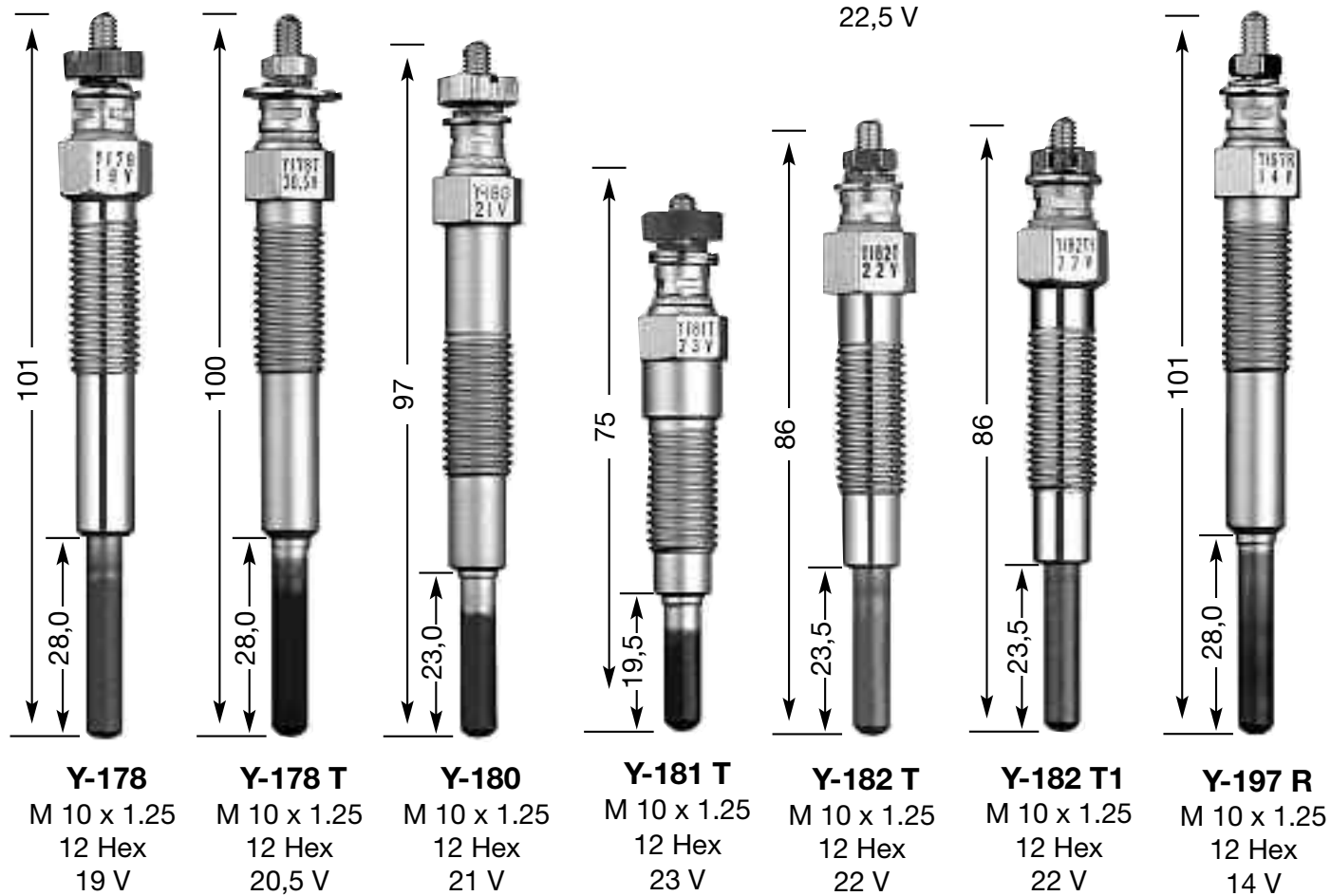
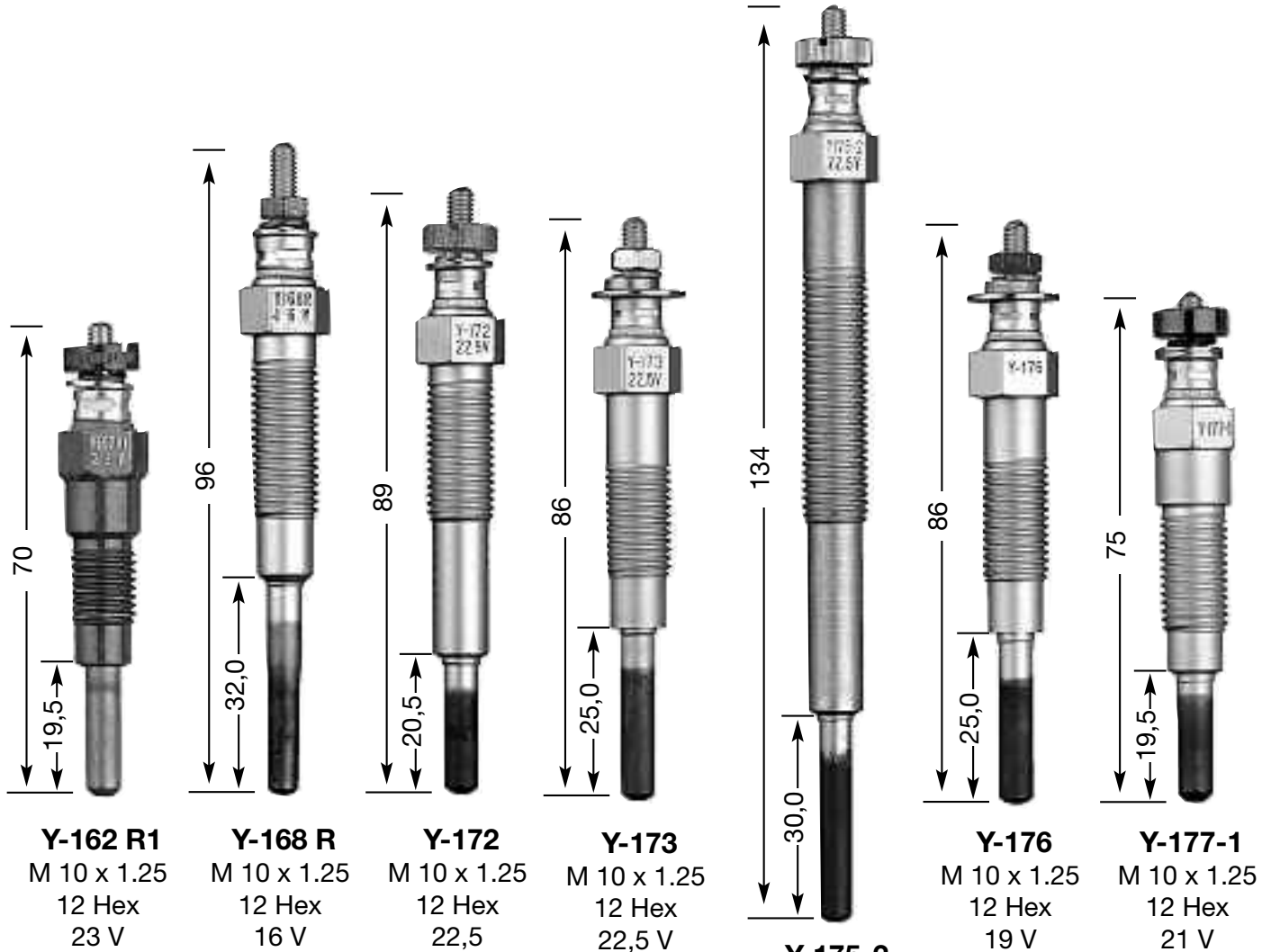

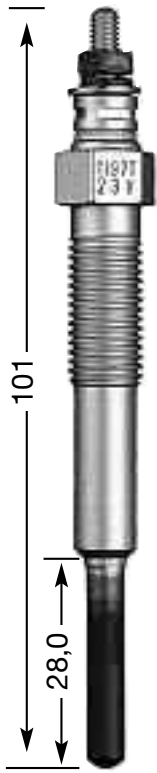

Y-197 T
M 10 x 1.25
12 Hex
23 V

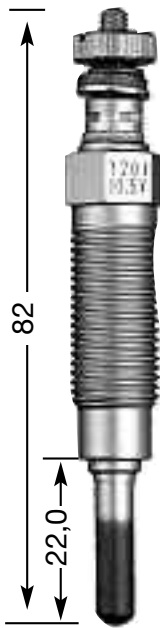

Y-201
M 12 x 1.25
12 Hex
10,5 V

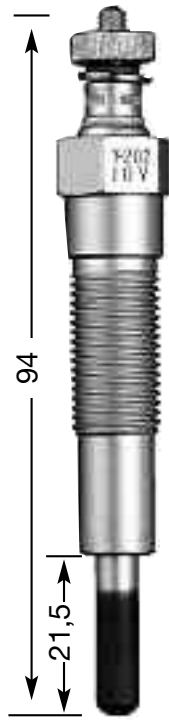

Y-202
M 12 x 1.25
14 Hex
10 V

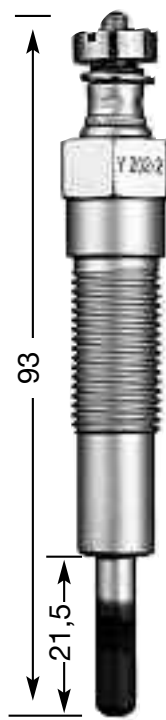

Y-202-2
M 12 x 1.25
14 Hex

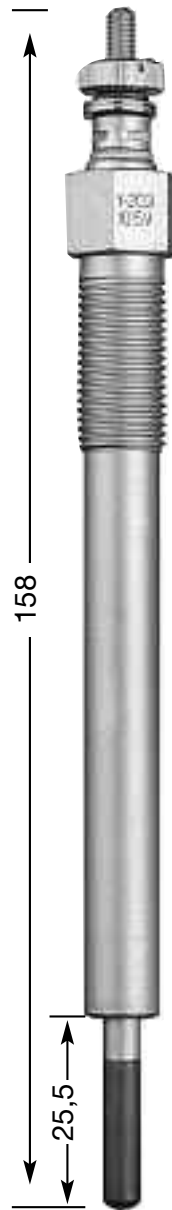

Y-203
M 12 x 1.25
14 Hex
10,5 V

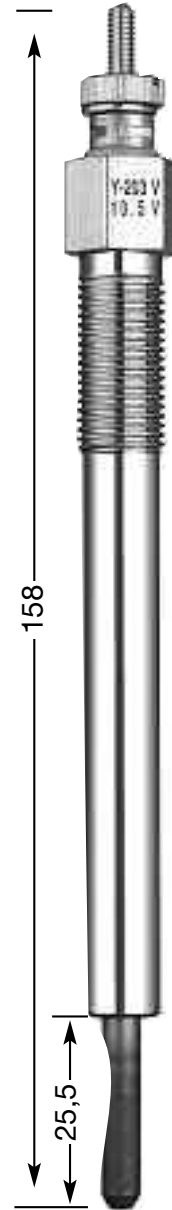

Y-203 V
M 12 x 1.25
14 Hex
10,5 V

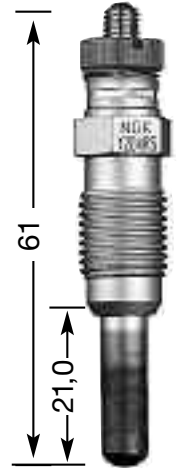

Y-204 RS
M 12 x 1.25
12 Hex
6,5 V

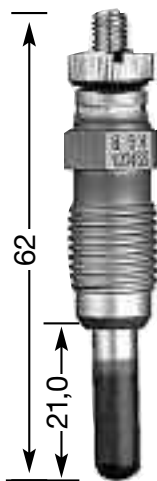

Y-204 SS
M 12 x 1.25
12 Hex
8,5 V

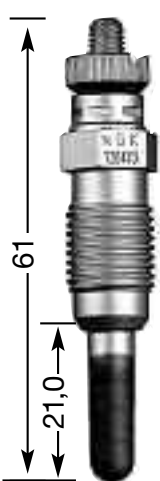

Y-204 TS1
M 12 x 1.25
12 Hex
11 V

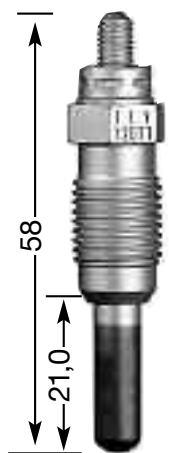

Y-207 T
M 12 x 1.25
12 Hex
11 V

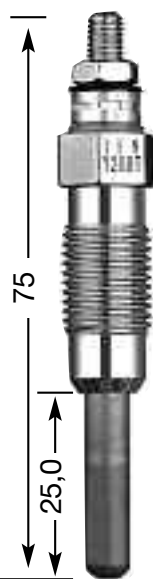

Y-208 T
M 12 x 1.25
12 Hex
11 V

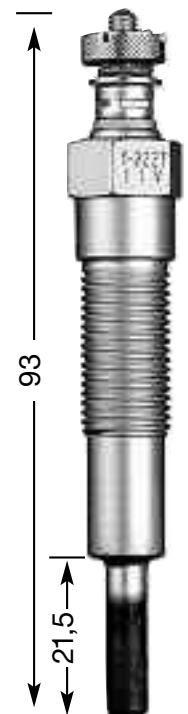

Y-222 T
M 12 x 1.25
14 Hex
11 V

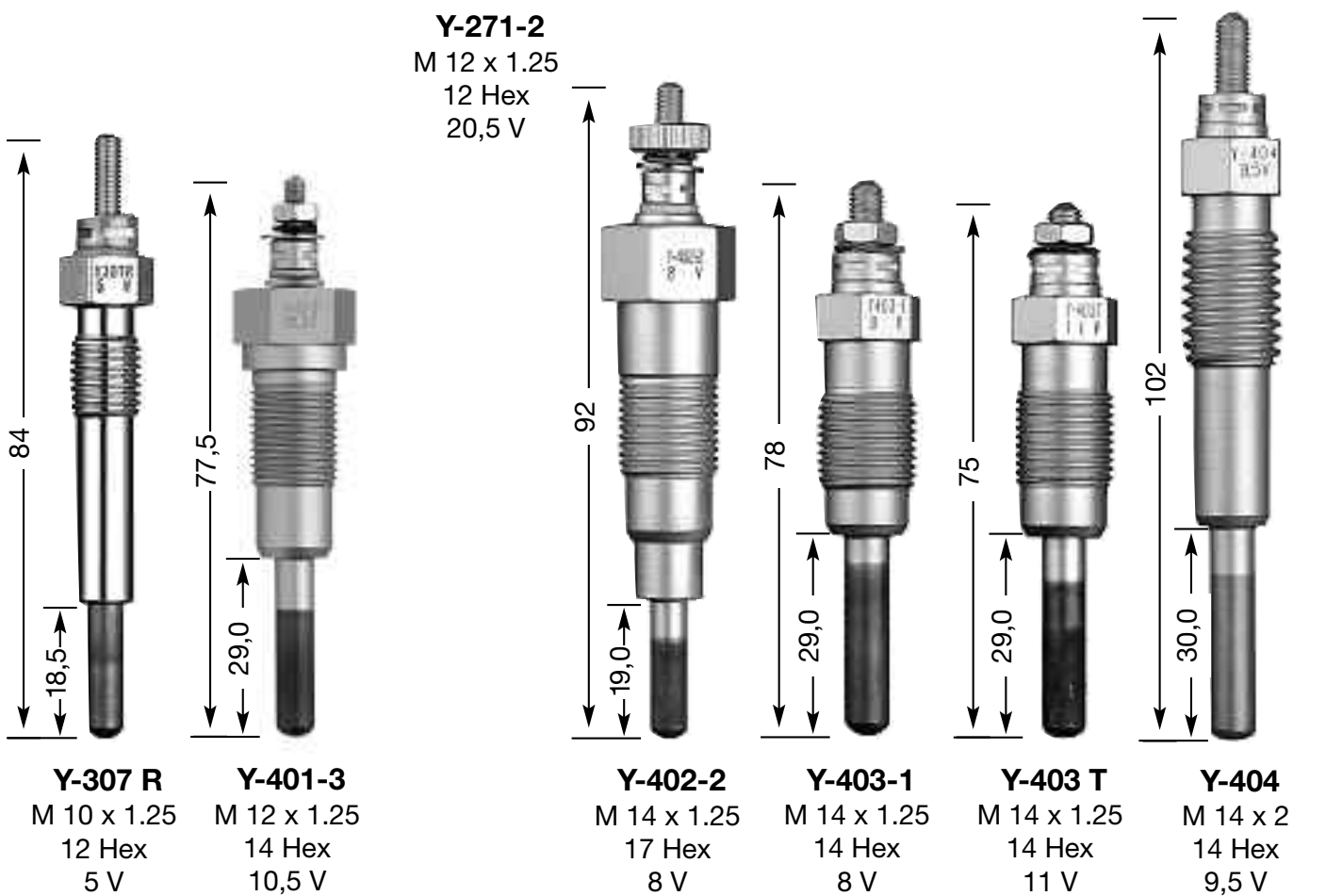
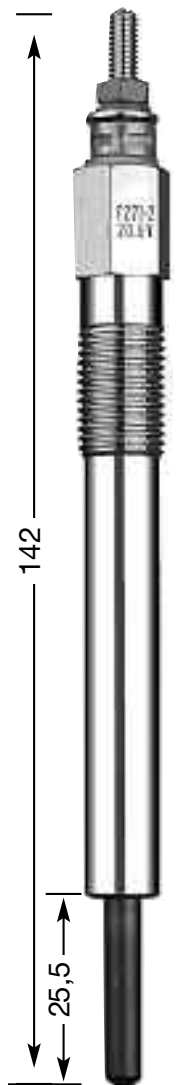
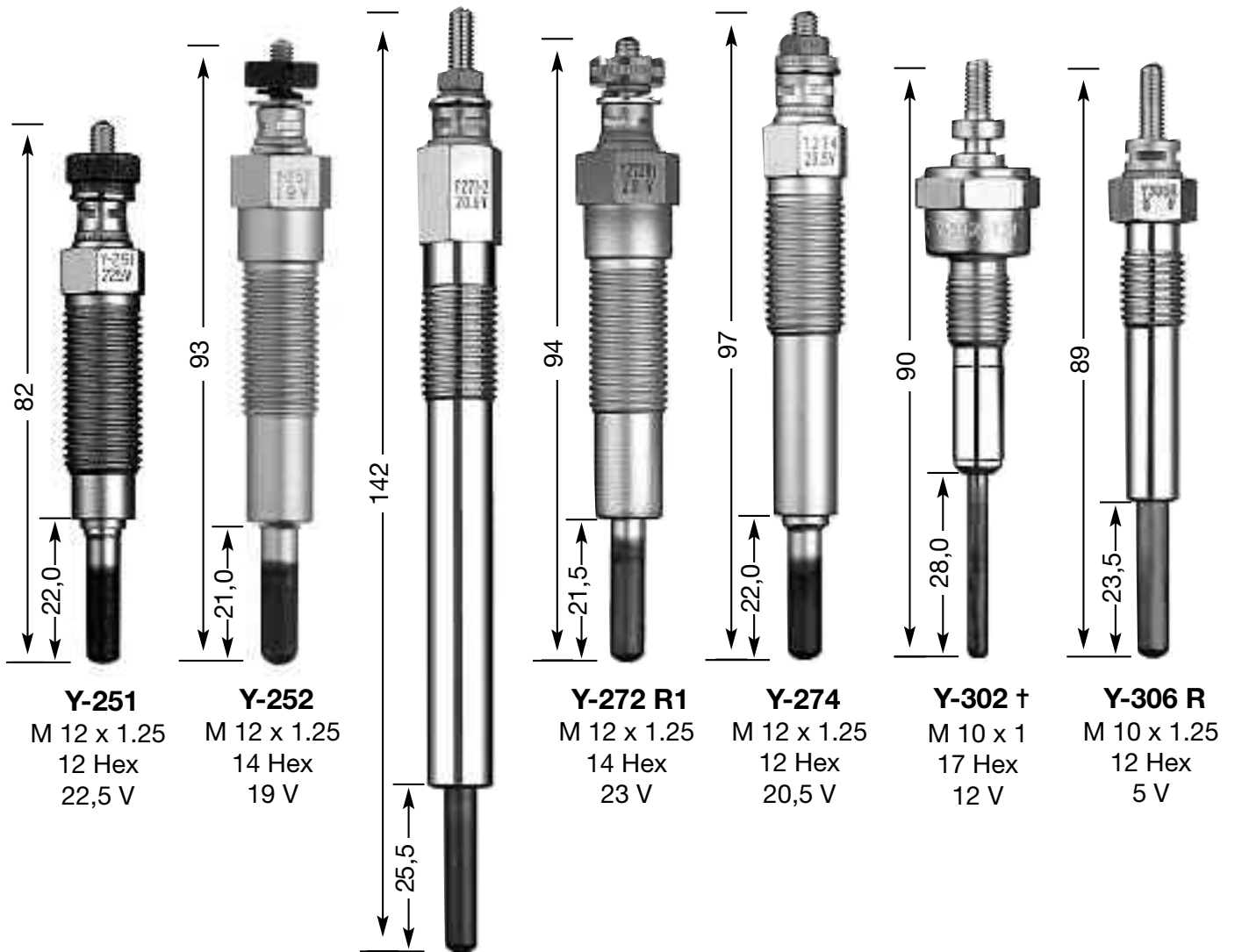

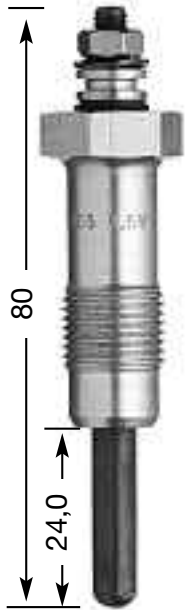

Y-405
M 14 x 1.25
17 Hex
9,5 V

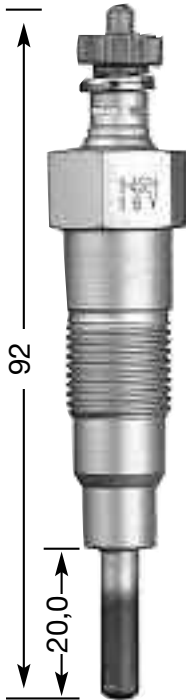

Y-452-1
M 14 x 1.25
17 Hex
19 V

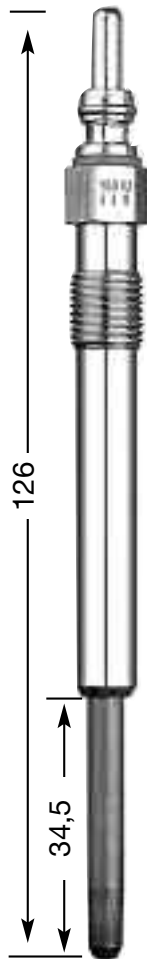

Y-501-U
M 10 x 1.0
10 Hex
11 V
DP 31

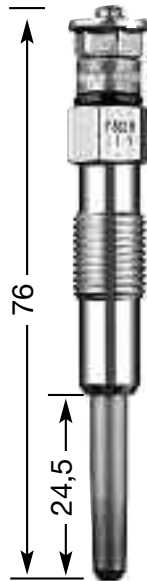

Y-502 R
M 10 x 1.0
10 Hex
11 V

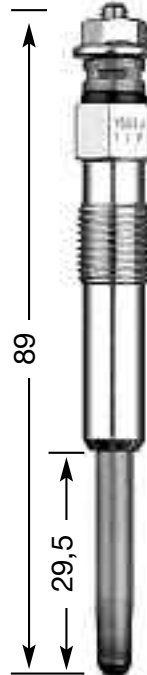

Y-503 J
M 10 x 1.0
10 Hex
11 V
DP 10

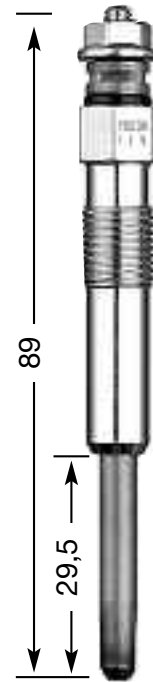

Y-503 R
M 10 x 1.0
10 Hex
11 V

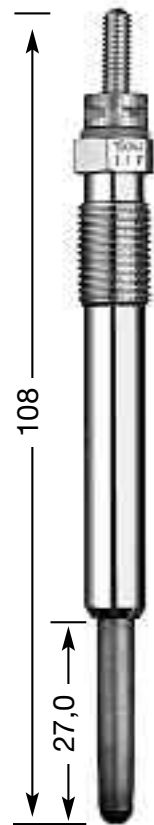

Y-504 J
M 10 x 1.0
10 Hex
11 V
DP 24

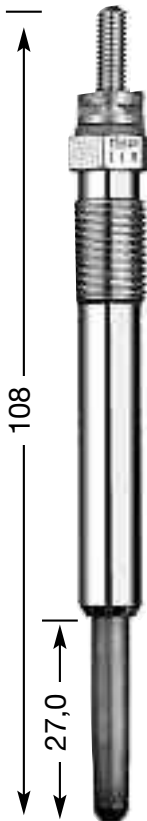

Y-504 R
M 10 x 1.0
10 Hex
11 V

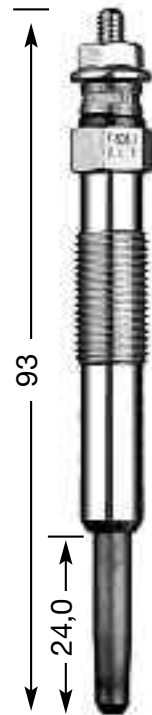

Y-506 J
M 10 x 1.0
10 Hex
11 V
DP 7

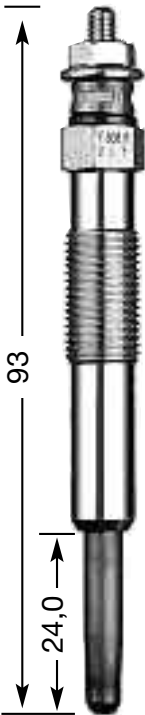

Y-506 R
M 10 x 1.0
10 Hex
11 V



Y-507 J
M 10 x 1.0
10 Hex
11 V
DP 32

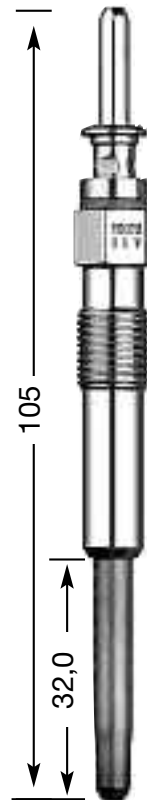

Y-507 R
M 10 x 1.0
10 Hex
11 V

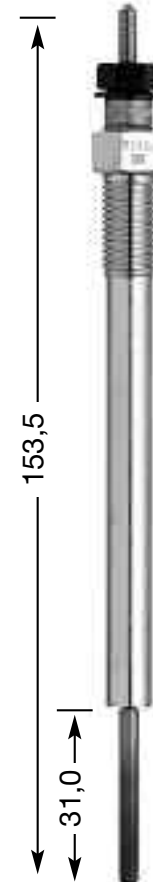

Y-508 J
M 10 x 1.25
12 Hex
11 V

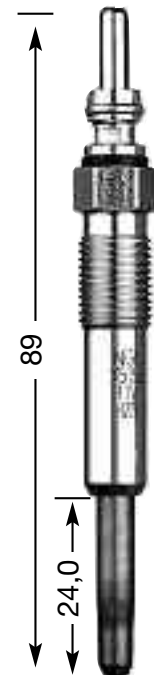

Y-515 J
M 10 x 1.0
10 Hex
11 V
DP 18

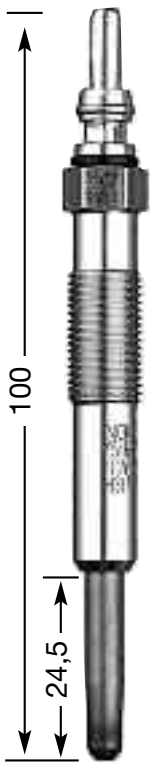

Y-516 J
 M 10 x 1.0
 10 Hex
 11 V
DP 12

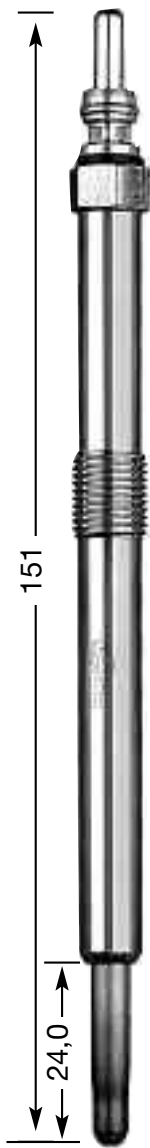

Y-517 J
 M 10 x 1.0
 10 Hex
 11 V

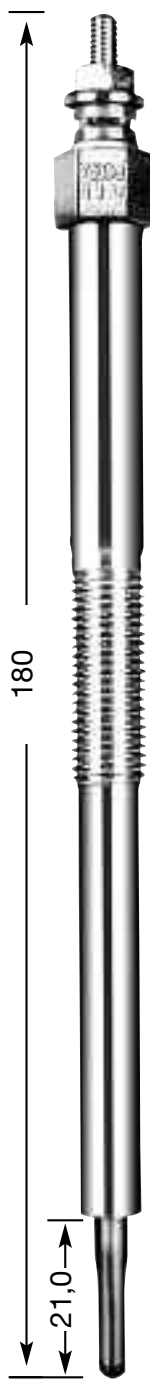

Y-519 J
 M 12 x 1.0
 10 Hex
 11 V
DP 61

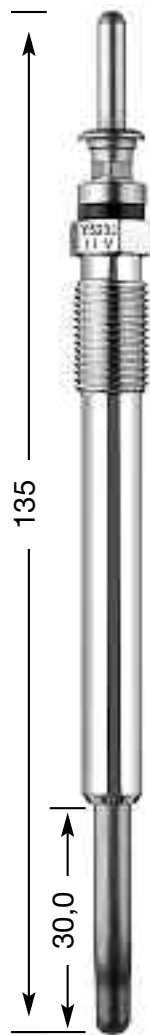

Y-523 J
 M 10 x 1.0
 10 Hex
 11 V
DP 37

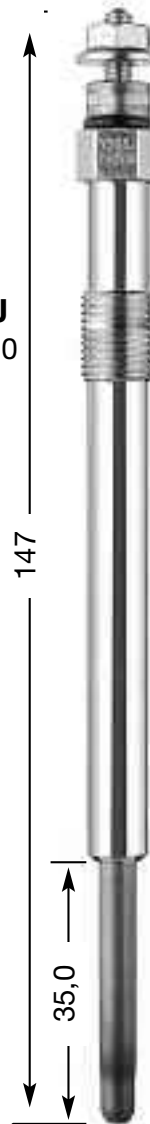

Y-525 J
 M 10 x 1,0
 10 Hex
 11,5 V
DP 35

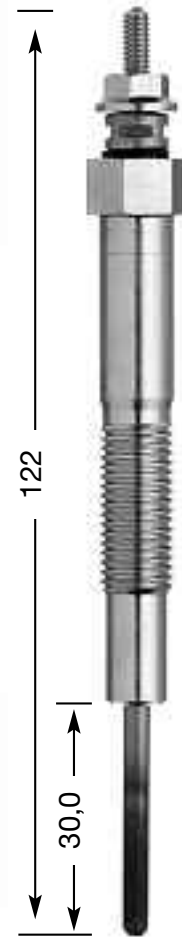

Y-529 J
 M 10 x 1.25
 12 Hex
 11 V



Y-524 J
 M 10 x 1.0
 10 Hex
 10 V
DP 27

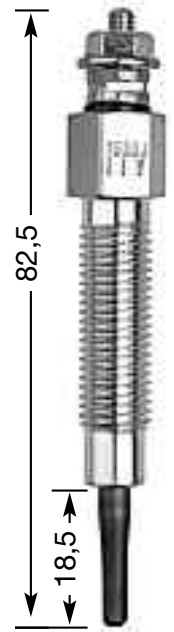

Y-530 J
 M 10 x 1.25
 12 Hex
 11 V

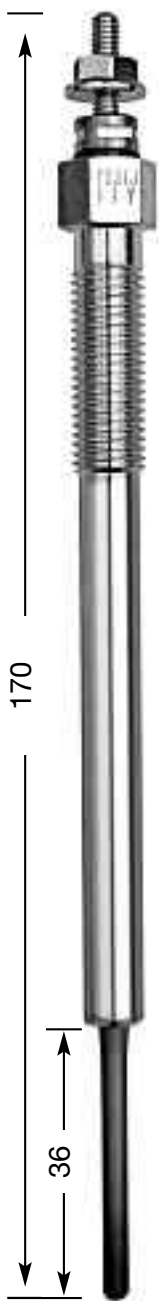

Y-531 J
M 10 x 1.25
12 Hex
11 V
DP 44

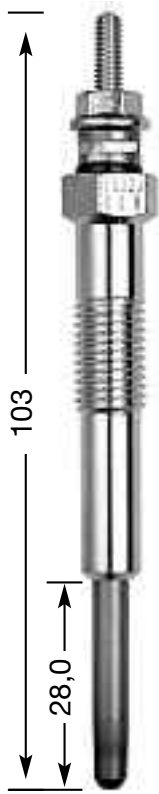

Y-532 J
M 10 x 1.25
12 Hex
11 V

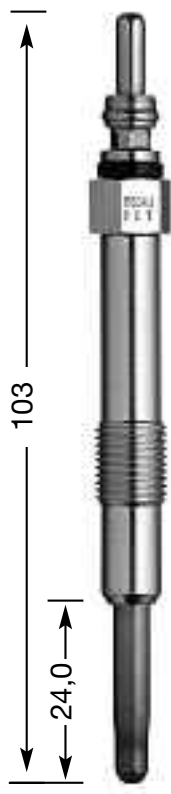

Y-534 J
M 10 x 1.0
10 Hex
11 V
DP 36

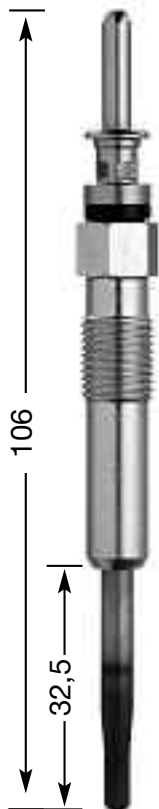

Y-547 AS
M 10 x 1.0
10 Hex
5 V
DP 47



Y-603 J
M 12 x 1.25
12 Hex
11 V
DP 60

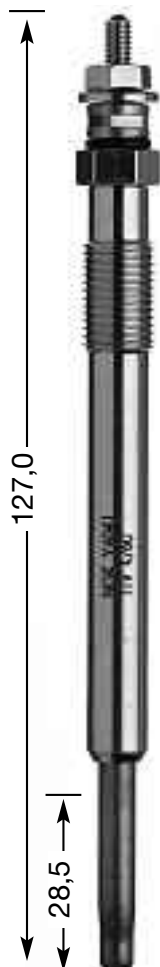

Y-604 J
M 10 x 1.0
10 Hex
11 V



Y-541 J
M 10 x 1.25
12 Hex
DP 42



Y-542 J
M 10 x 1.25
10 Hex
11 V
DP 45



Y-543 J
M 10 x 1.25
10 Hex
11 V
DP 46

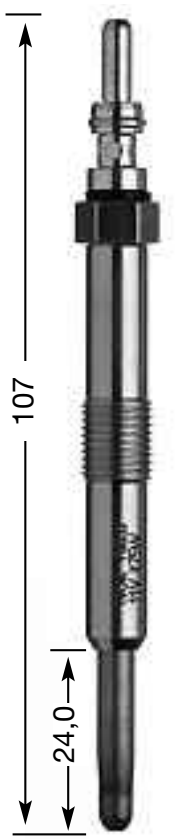

Y-605 J
M 10 x 1.0
10 Hex
11 V

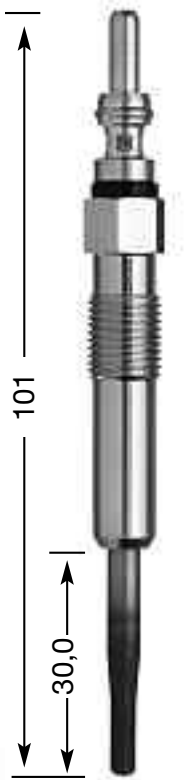

Y-607 AS
M 10 x 1.0
10 Hex
5 V
DP 50

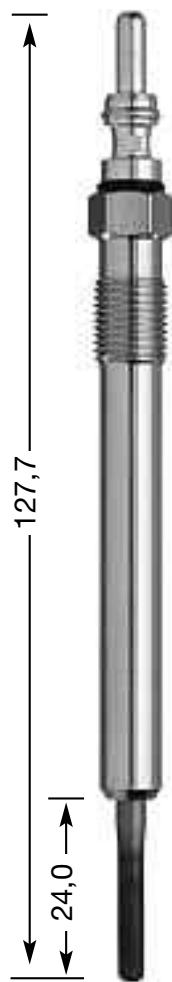

Y-609 AS
M 10 x 1.0
10 Hex
4,4 V
DP 49

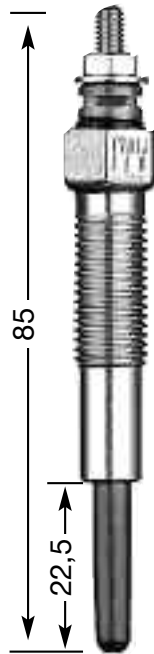

Y-701 J
M 10 x 1.25
12 Hex
11 V
DP 39

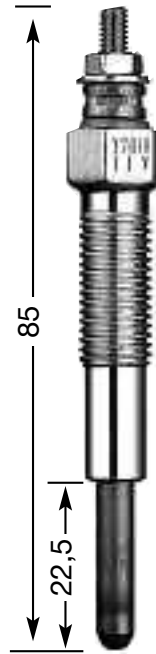

Y-701 R
M 10 x 1.25
12 Hex
11 V

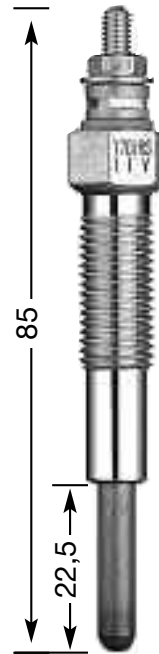

Y-701 RS
M 10 x 1.25
12 Hex
11 V



Y-701 U
M 10 x 1.25
12 Hex
10 V

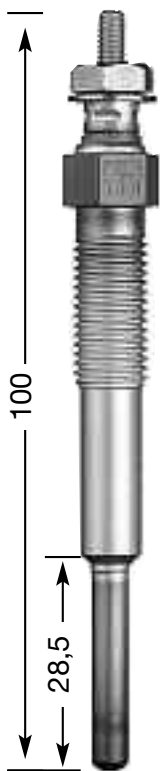

Y-703 R
M 10 x 1.25
12 Hex
11 V

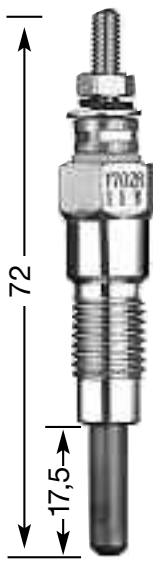

Y-702 R
M 10 x 1.25
12 Hex
11 V

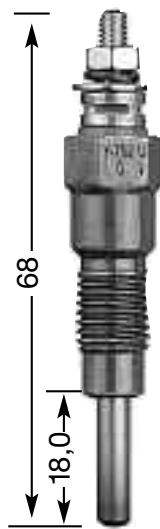

Y-702 U
M 10 x 1.25
12 Hex
10 V

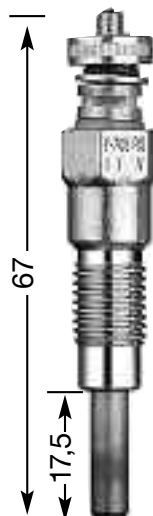

Y-705 RS
M 10 x 1.25
12 Hex
11 V

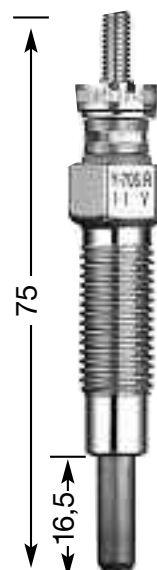

Y-706 R
M 10 x 1.25
12 Hex
11 V

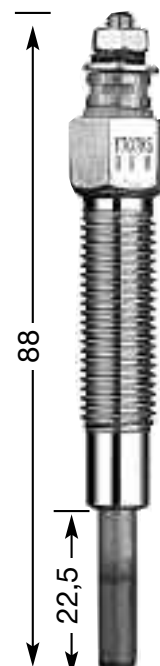

Y-707 RS
M 10 x 1.25
12 Hex
11 V

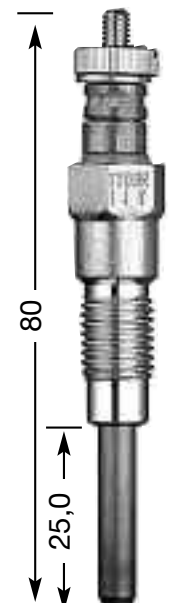

Y-709 R
M 10 x 1.25
12 Hex
11 V

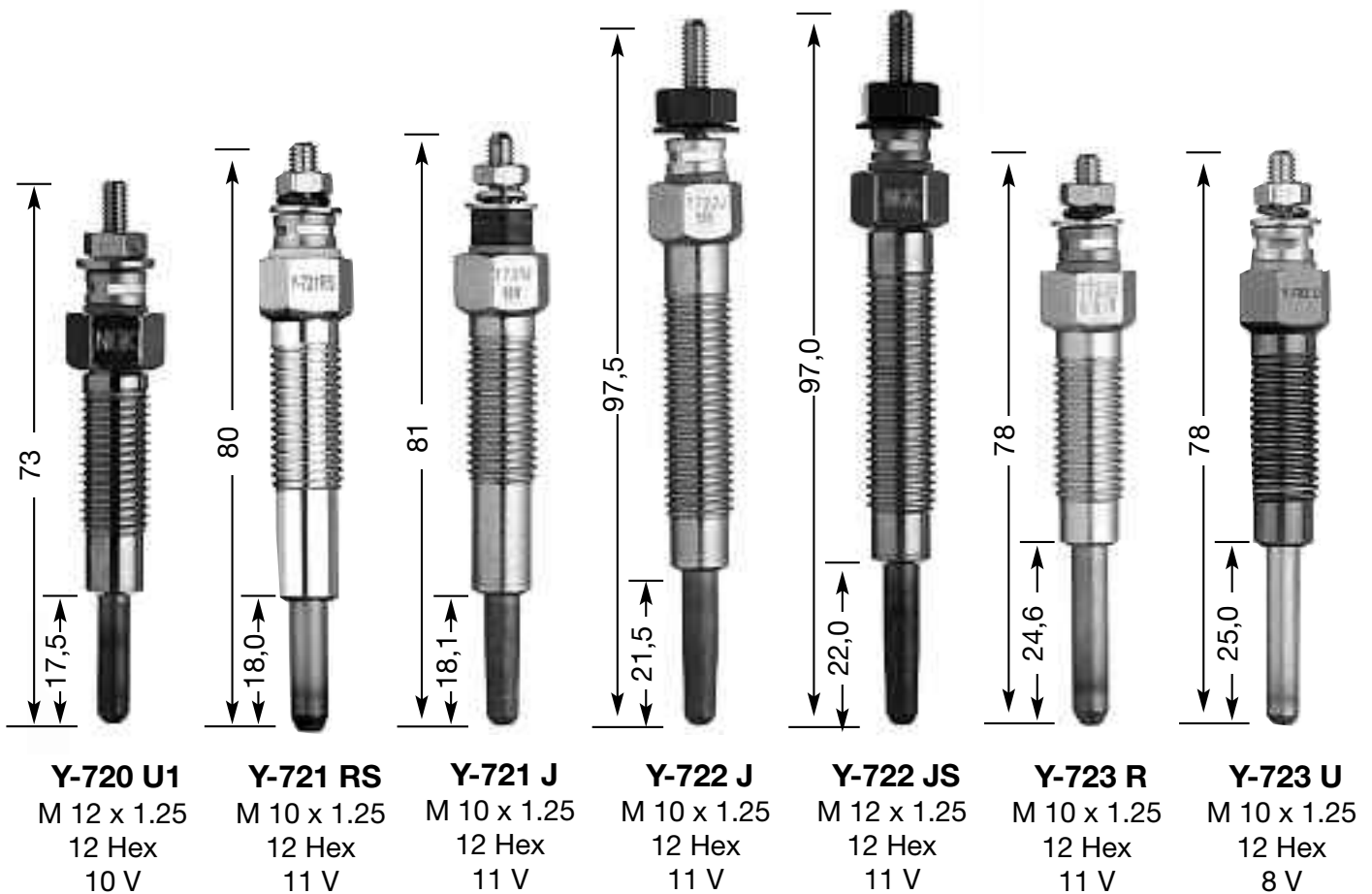
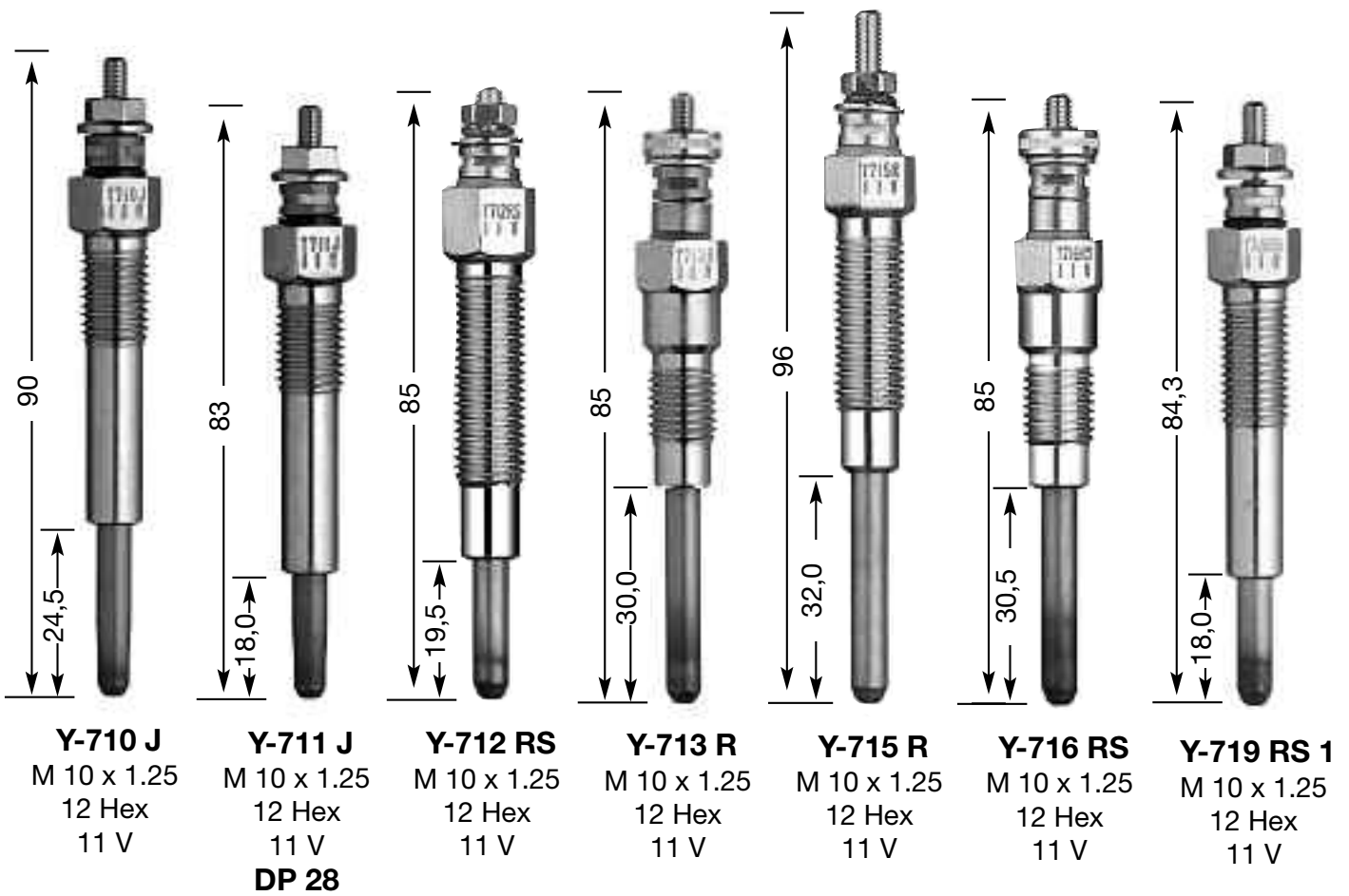

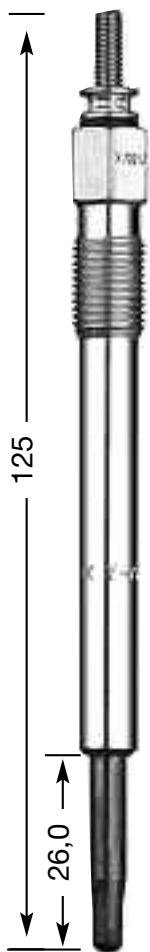

Y-729 U
M 10 x 1.0
10 Hex
11,5 V
DP 34

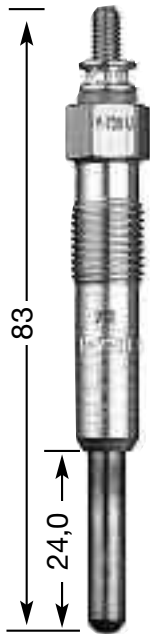

Y-730 U
M 10 x 1.0
10 Hex
11 V
DP 17

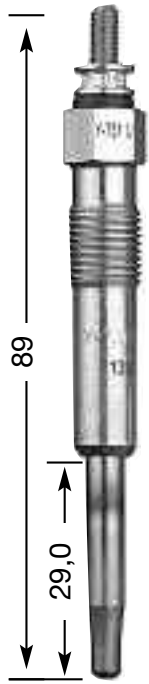

Y-731 U
M 10 x 1.0
10 Hex
11 V
DP 9

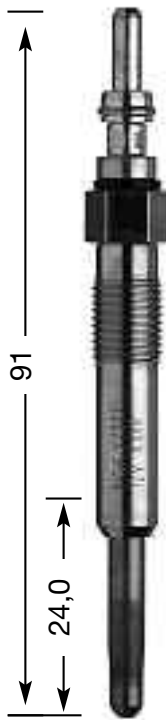

Y-732 J
M 10 x 1.0
10 Hex
12 V
DP 4

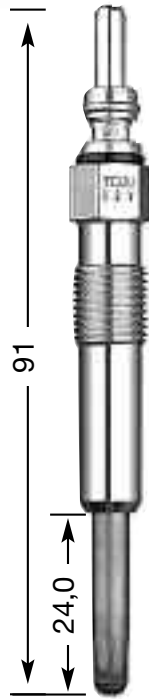

Y-732 U
M 10 x 1.0
10 Hex
12 V
DP 4

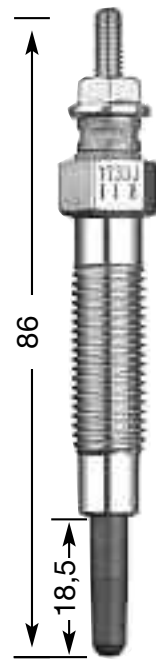

Y-733 J
M 10 x 1.25
12 Hex
11 V
DP 13

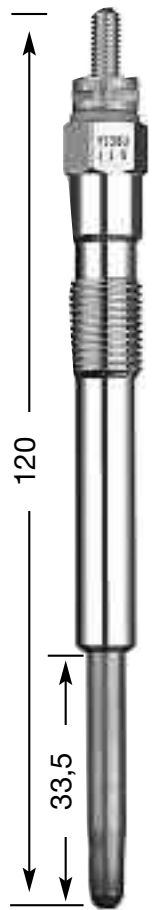

Y-738 U
M 10 x 1.0
10 Hex
11 V

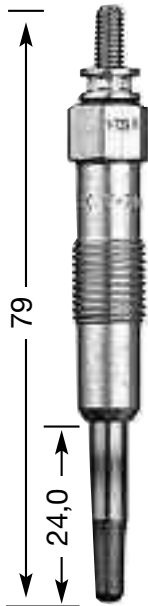

Y-739 R
M 10 x 1.0
10 Hex
11 V

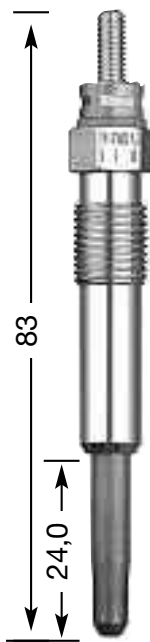

Y-740 U
M 10 x 1.0
10 Hex
11 V
DP 22

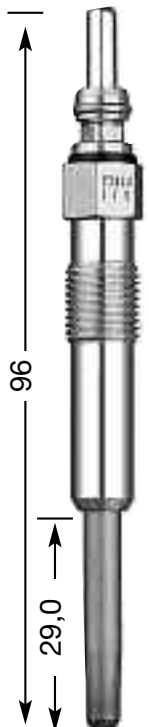

Y-741 U
M 10 x 1
10 Hex
11 V
DP 20

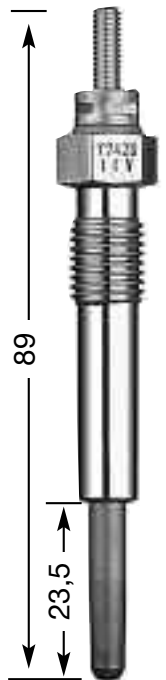

Y-742 U
M 10 x 1.25
12 Hex
11 V

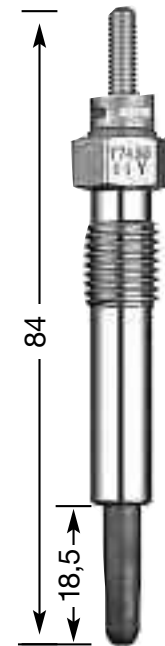

Y-743 U
M 10 x 1.25
12 Hex
11 V

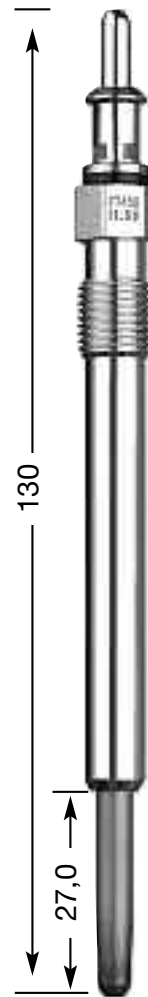

Y-745 U
M 10 x 1.0
10 Hex
11,5 V
DP 11

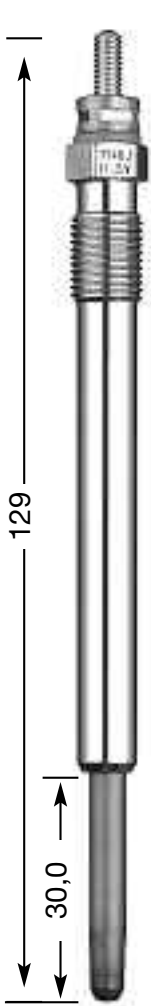

Y-746 J
M 10 x 1.0
10 Hex
11,5 V
DP 38

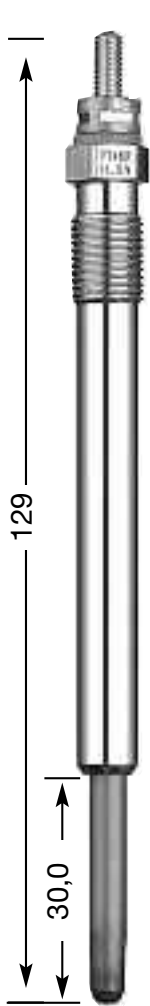

Y-746 R
M 10 x 1.0
10 Hex
11,5 V

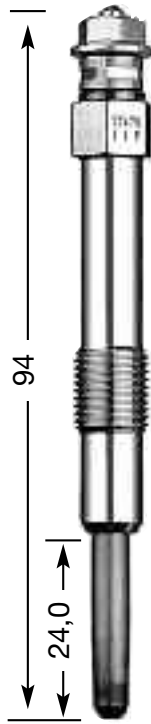

Y-747 U
M 10 x 1
10 Hex
11 V
DP 26

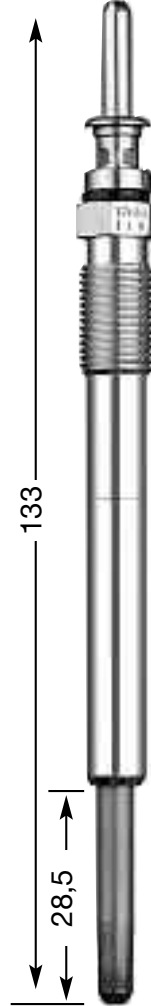

Y-748 U
M 10 x 1
10 Hex
11 V
DP 14



Y-749 J
M 10 x 1.0
10 Hex
11 V

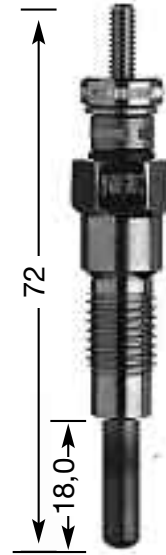

Y-752 M
M 12 x 1.25
12 Hex
23 V

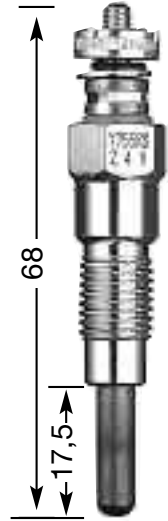

Y-755 RS
M 10 x 1.25
12 Hex
24 V

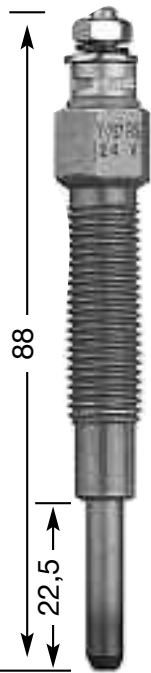

Y-757 RS
M 10 x 1.25
12 Hex
24 V



Y-766 MS
M 10 x 1.25
12 Hex
23 V

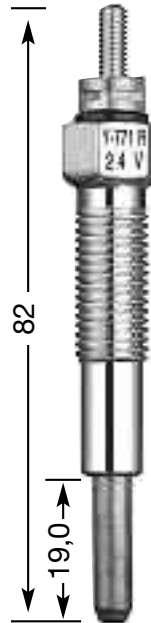

Y-771 R
M 10 x 1.25
12 Hex
24 V

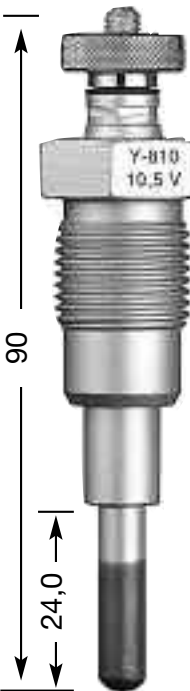

Y-810
M 18 x 1.5
20.6 Hex
10,5 V

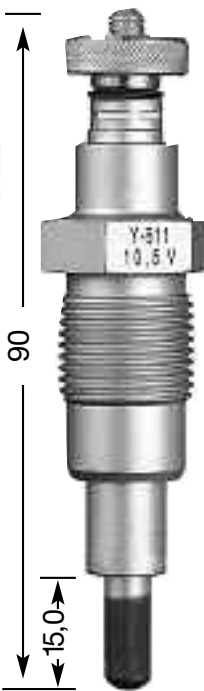

Y-811
M 18 x 1.5
20.6 Hex
10,5 V

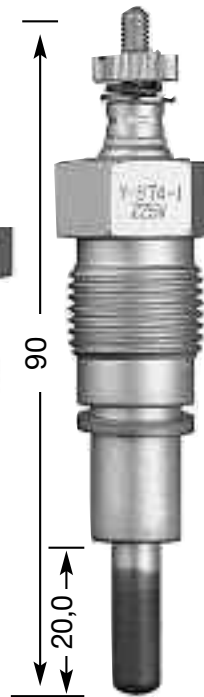

Y-874-1
M 18 x 1.5
19 Hex
22,5 V

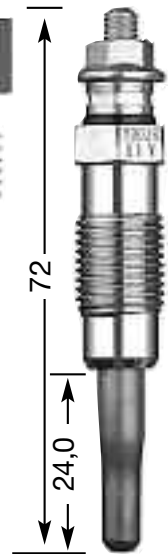

Y-902 R
M 12 x 1.25
12 Hex
11 V

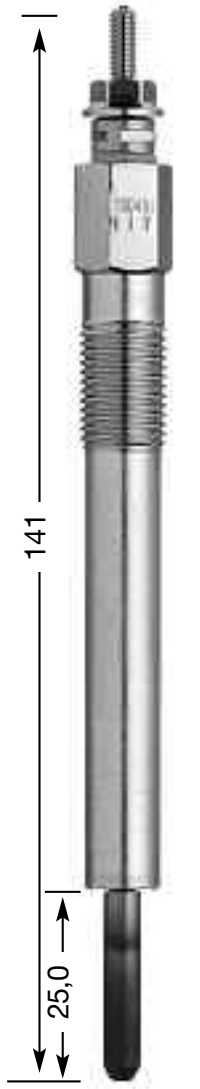

Y-904 M1
M 12 x 1.25
12 Hex
11 V

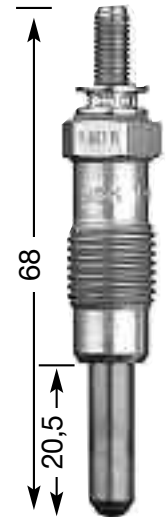

Y-907 R
M 12 x 1.25
12 Hex
11,5 V

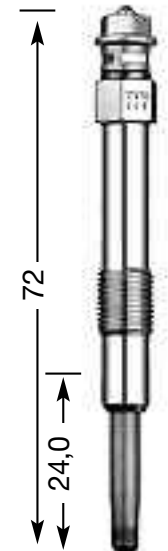

Y-908 R
M 12 x 1.25
12 Hex
11 V

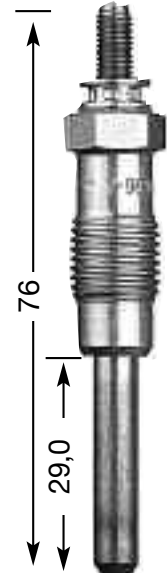

Y-909 R
M 12 x 1.25
12 Hex
11 V

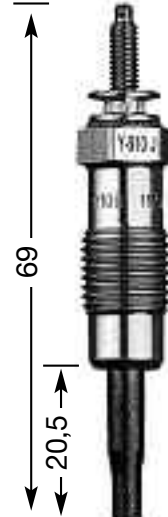

Y-910 J
M 12 x 1.25
12 Hex
11,5 V
DP 3

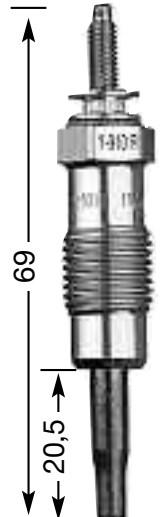

Y-910 R
M 12 x 1.25
12 Hex
11,5 V

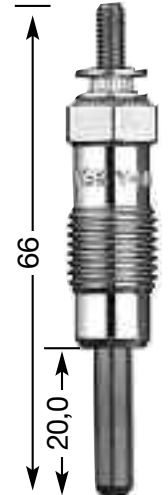

Y-911 J
M 12 x 1.25
12 Hex
11 V
DP 33

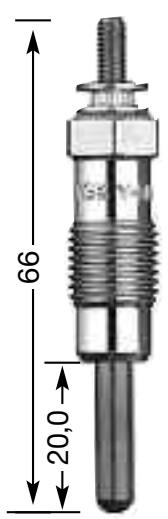

Y-911 R
M 12 x 1.25
12 Hex
11 V

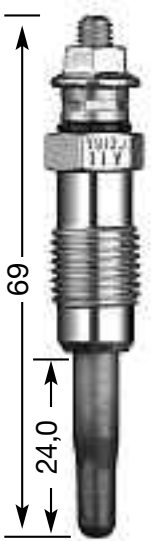

Y-913 J
M 12 x 1.25
12 Hex
11 V
DP 15

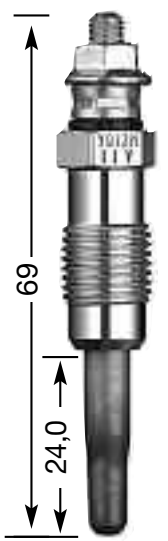

Y-913 M
M 12 x 1.25
12 Hex
11 V

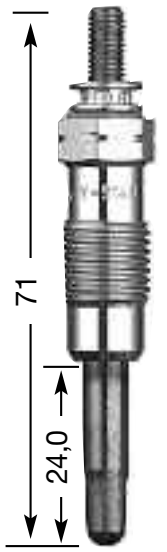

Y-914 U
M 12 x 1.25
12 Hex
11 V

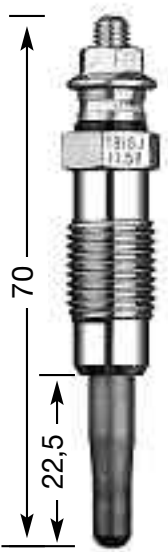

Y-916 J
M 12 x 1.25
12 Hex
11,5 V
DP 6

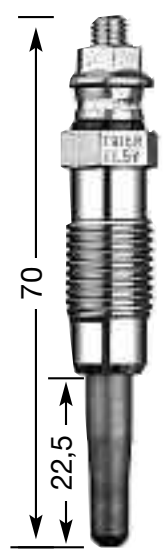

Y-916 R
M 12 x 1.25
12 Hex
11,5 V

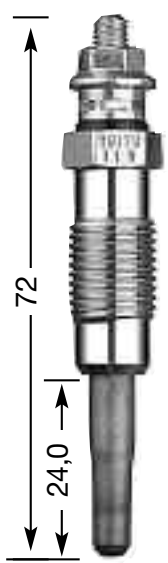

Y-917 U
M 12 x 1.25
12 Hex
11 V

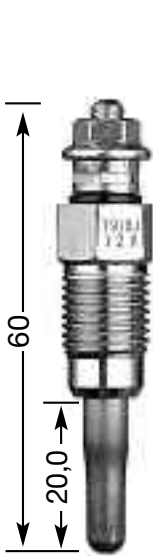

Y-918 J
M 12 x 1.25
12 Hex
12 V
DP 2

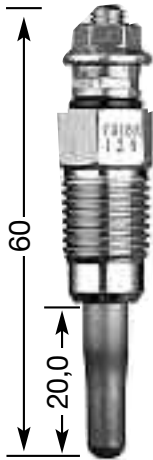

Y-918 R
M 12 x 1.25
12 Hex
12 V

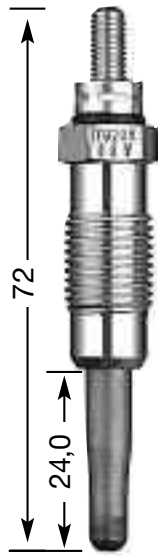

Y-920 R
M 12 x 1.25
12 Hex
11 V

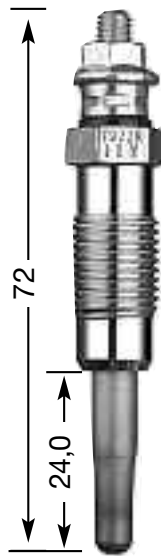

Y-922 R
M 12 x 1.25
12 Hex
11 V

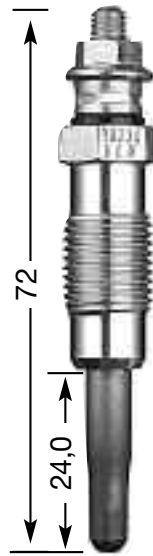

Y-923 U
M 12 x 1.25
12 Hex
11 V

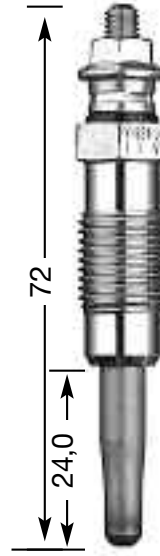

Y-924 J
M 12 x 1.25
12 Hex
11 V
DP 1

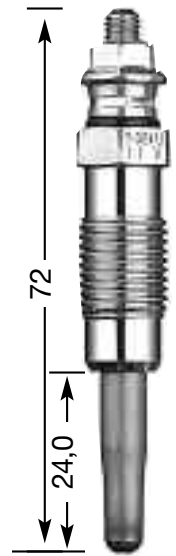

Y-924 U
M 12 x 1.25
12 Hex
11 V

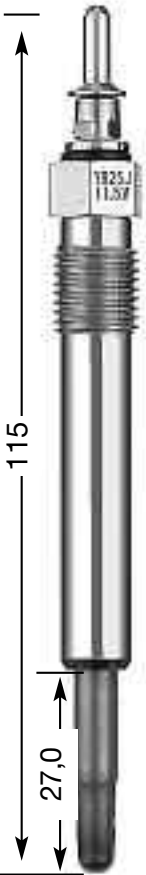

Y-925 J
M 12 x 1.25
12 Hex
11,5 V
DP 16

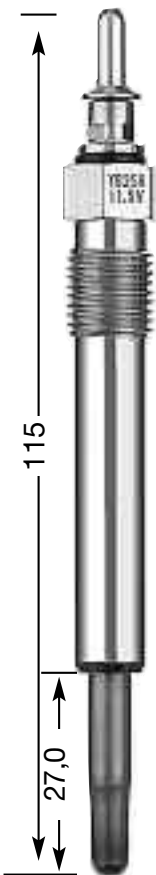

Y-925 R
M 12 x 1.25
12 Hex
11,5 V



Y-926 U
M 12 x 1.25
12 Hex
11 V

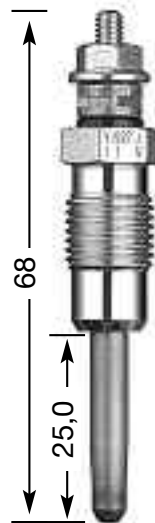

Y-927 J
M 12 x 1.25
12 Hex
11 V
DP 19

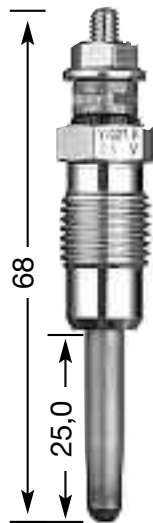

Y-927 R
M 12 x 1.25
12 Hex
11 V

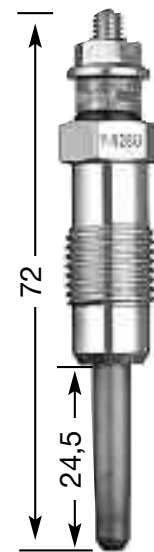

Y-928 U
M 12 x 1.25
12 Hex
11 V
DP 29

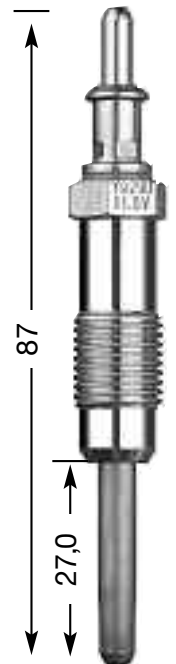

Y-929 U
M 12 x 1.25
12 Hex
11,5 V
DP 41

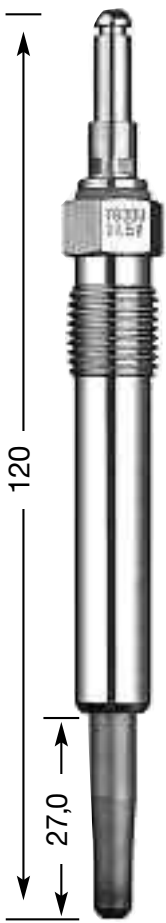

Y-930 U
M 12 x 1.25
12 Hex
11,5 V
DP 30

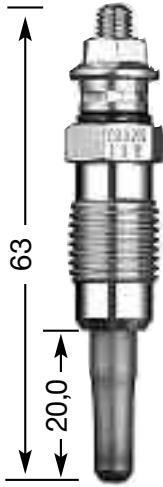

Y-932 R
M 12 x 1.25
12 Hex
11 V

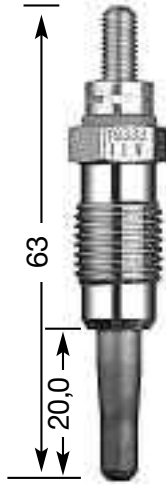

Y-933 J
M 12 x 1.25
12 Hex
11 V
DP 25

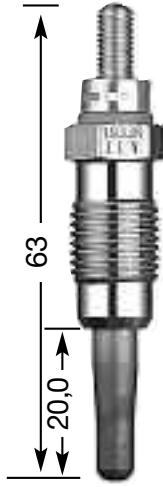

Y-933 R
M 12 x 1.25
12 Hex
11 V

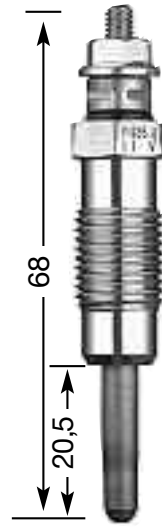

Y-935 U
M 12 x 1.25
12 Hex
11 V
DP 23

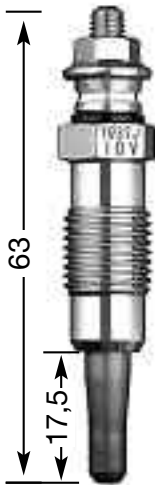

Y-937 J
M 12 x 1.25
12 Hex
10 V
DP 5

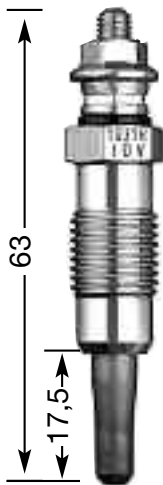

Y-937 R
M 12 x 1.25
12 Hex
10 V

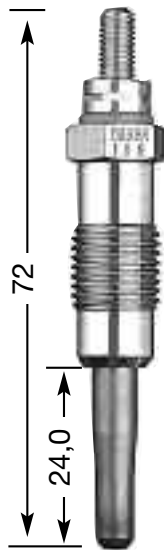

Y-938 R
M 12 x 1.25
12 Hex
11 V



Y-939 J
M 12 x 1.25
12 Hex
11 V
DP 43

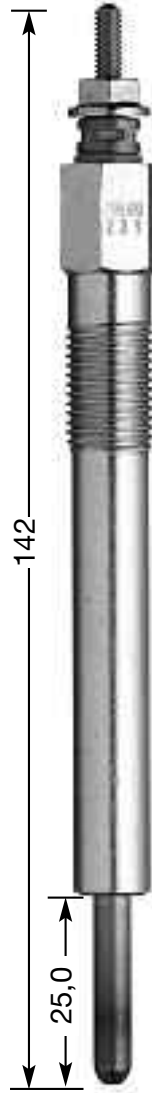

Y-954 M1
M 12 x 1.25
12 Hex
23 V

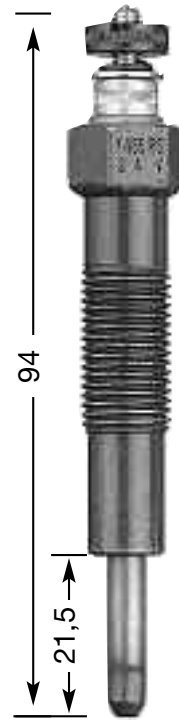

Y-955 RS
M 12 x 1.25
14 Hex
24 V

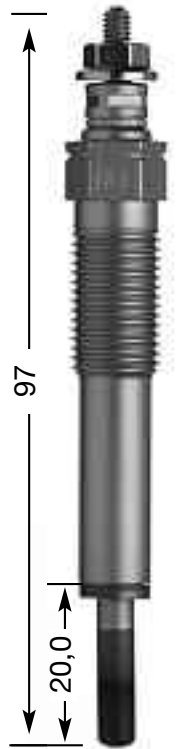

Y-971 M
M 12 x 1.25
12 Hex
23 V

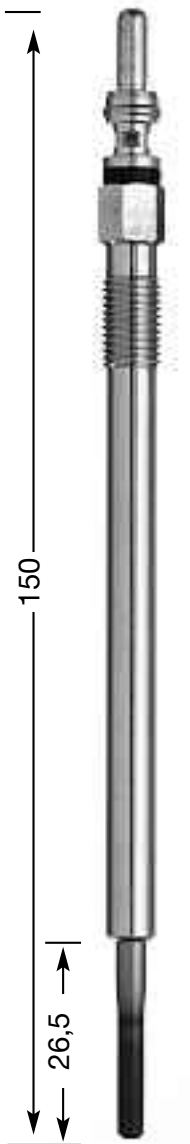

Y-8002 AS
M 8 x 1.0
8 Hex
4,4 V
DP 51

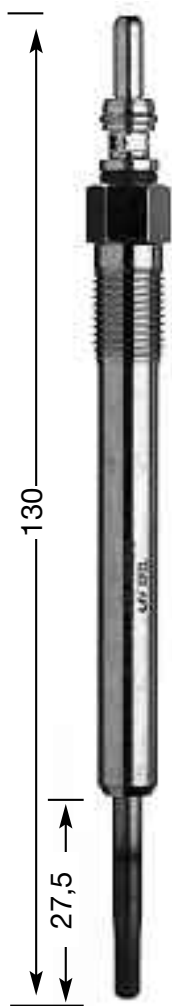

Y1002 AS
M 10 x 1.0
10 Hex
4,4 V
DP 57



Y1005 J
M 10 x 1.0
10 Hex
11 V
DP 56

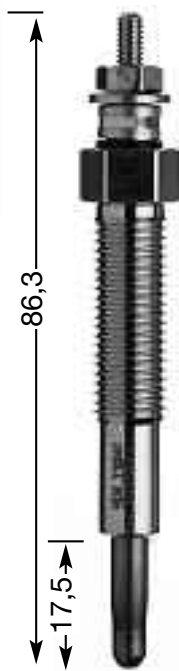

Y1006 J
M 12 x 1.25
12 Hex
11 V

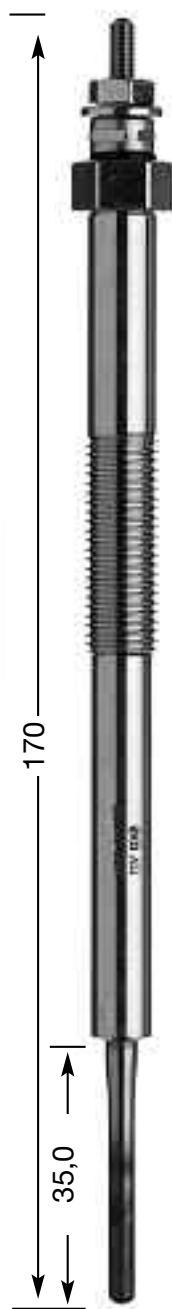

Y1007 J
M 12 x 1.25
12 Hex
11 V
DP 59



Y8001 AS
M 8 x 1.0
8 Hex
5 V
DP 58

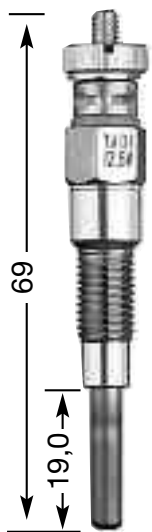

YA 01
M 8 x 1.0
10 Hex
12,5 V

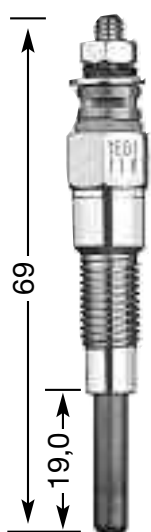

YE 01
M 8 x 1.0
10 Hex
11 V

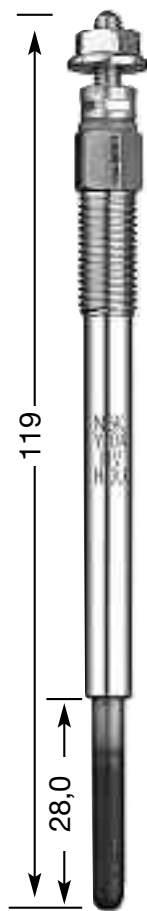

YE 04
M 8 x 1.0
8 Hex
11 V
DP 40

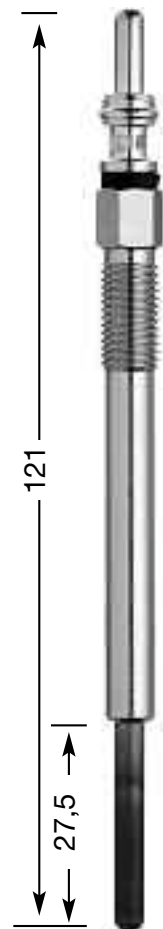

Y8003 J
M 8 x 1.0
8 Hex
11 V
DP 62

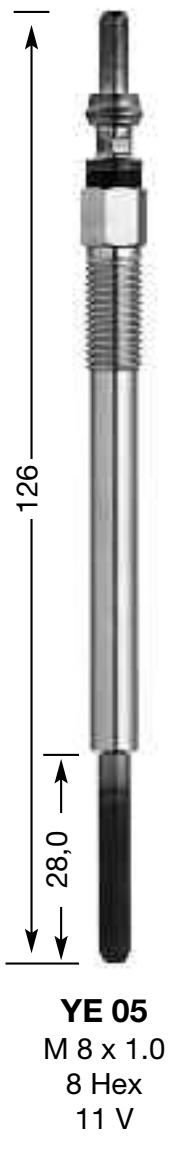

YE 05
M 8 x 1.0
8 Hex
11 V

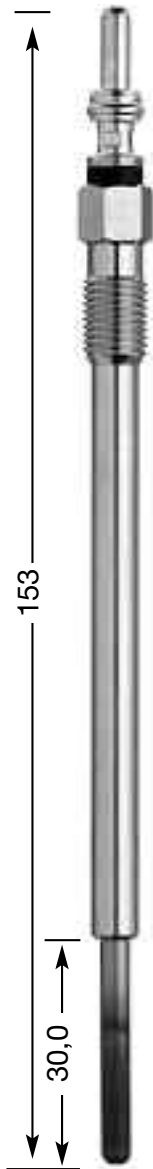

YE 07
M 9 x 1.0
9 Hex
11 V

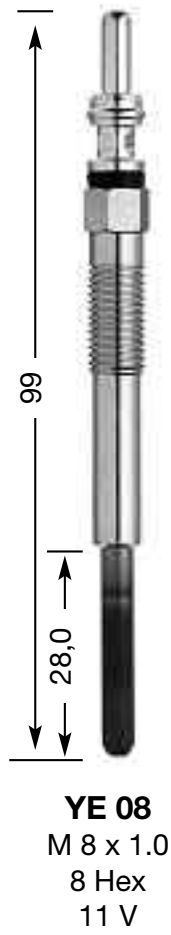

YE 08
M 8 x 1.0
8 Hex
11 V

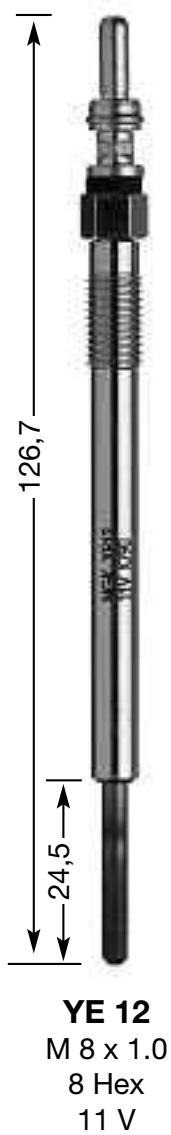

YE 12
M 8 x 1.0
8 Hex
11 V

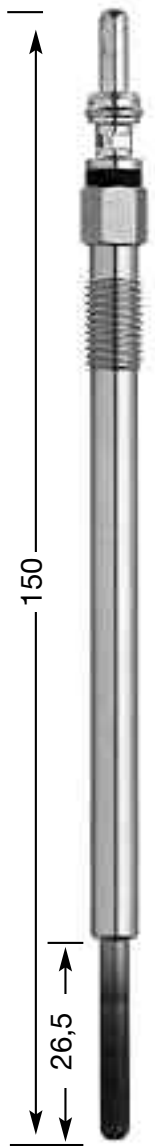

YE 13
M 8 x 1.0
8 Hex
11,5 V

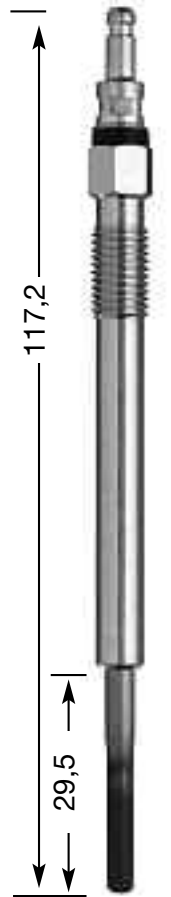

YE 14
M 8 x 1.0
8 Hex
4,4 V
DP 48

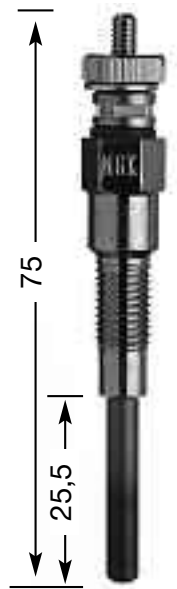

YE 52
M 10 x 1.0
10 Hex
23 V

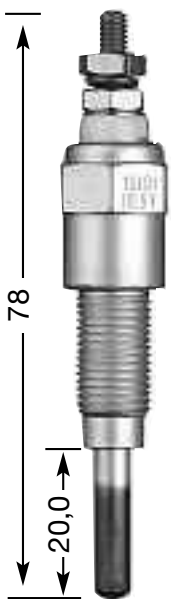

YS 101
M 10 x 1.0
14 Hex
10,5 V

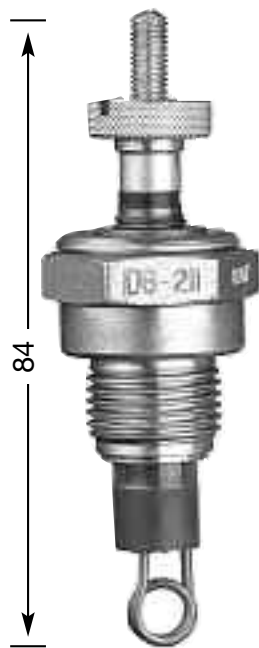

DG-211
M 18 x 1.5
25 Hex

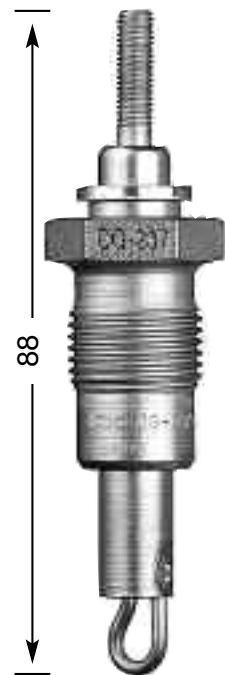

DG-237 +
M 18 x 1.5
21 Hex
0,9 V

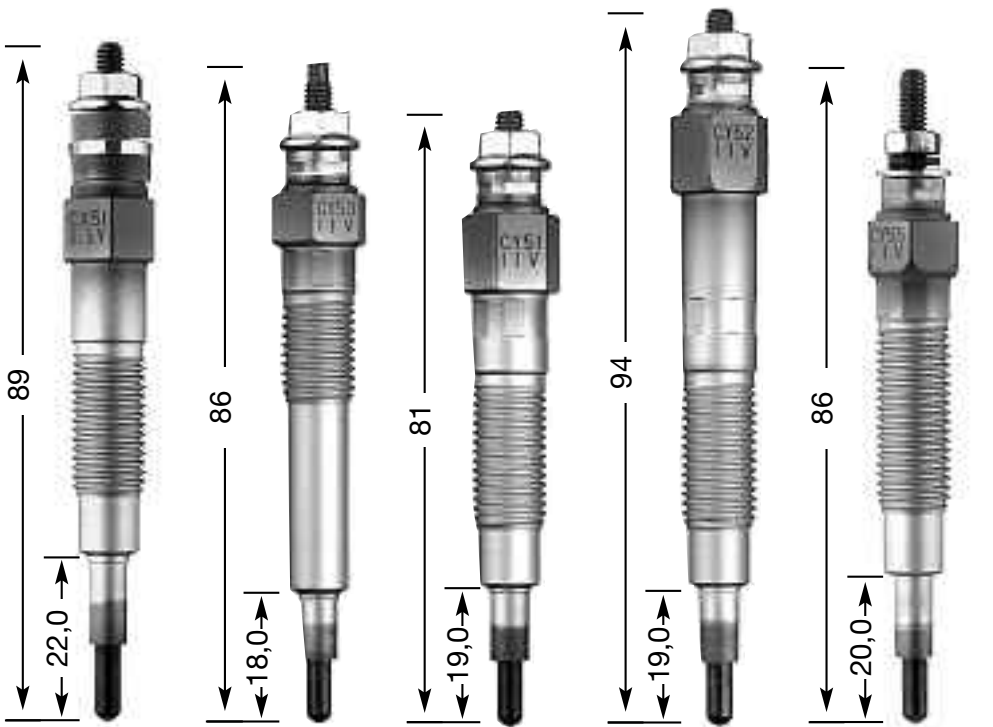

CX 51
M 10 x 1.25
10 Hex
6,5 V

CY 03
M 10 x 1.25
12 Hex
11 V
DP 8

CY 51
M 10 x 1.25
12 Hex
11 V

CY 52
M 10 x 1.25
12 Hex
11 V

CY 55
M 10 x 1.25
12 Hex
11 V

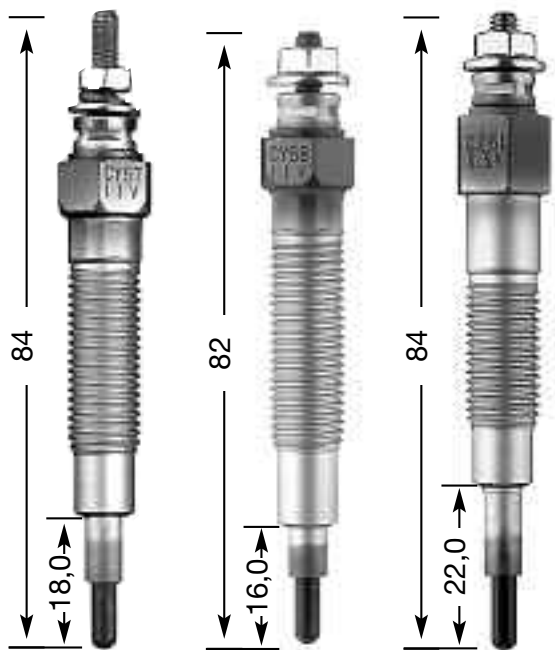

CY 57
M 10 x 1.25
12 Hex
11 V
DP 21

CY 58
M 10 x 1.25
12 Hex
11 V

CZ 51
M 10 x 1.25
12 Hex
6,5 V



CZ 104
M 10 x 1.0
10 Hex
7 V
DP 52

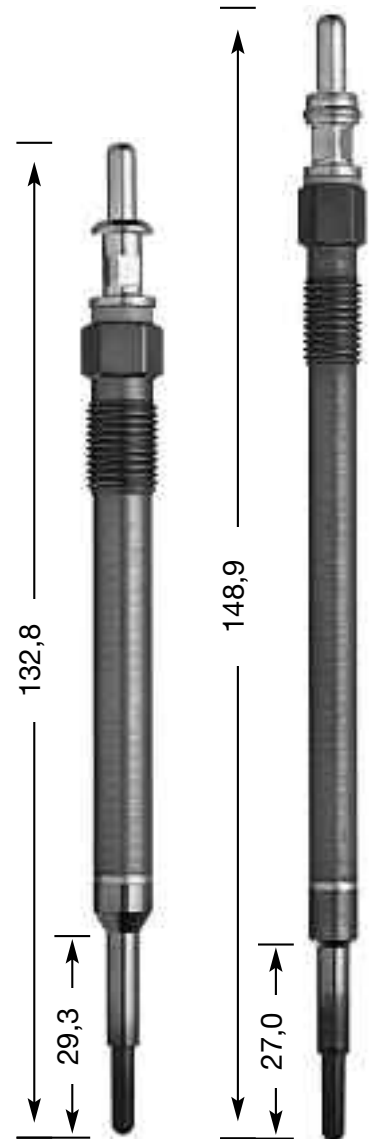

CZ 106
M 10 x 1.0
10 Hex
7 V
DP 53

CZ 303
M 8 x 1.0
8 Hex
7 V
DP 54

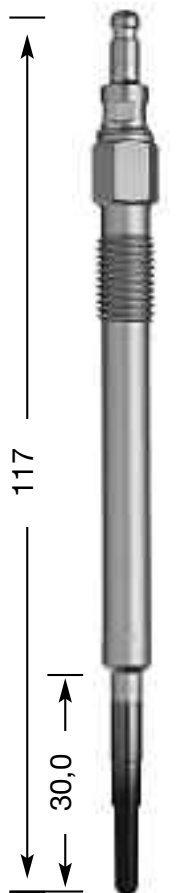

CZ 304
M 8 x 1.0
8 Hex
7 V
DP 55

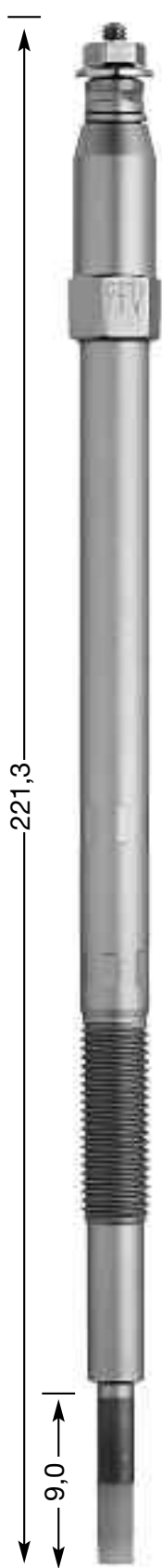

CZ 71
M 10 x 1.25
12 Hex
11 V



l kW

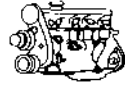

Cyl.

Order-
No. No.LPG/CNG
D-PowerOrder-
No.**ABARTH**

| | | | | | | | | | | | |
|-------------------------------------|-----|-----|--------|----------|---|-----|--------|------|--|--------|------|
| 500 1.4 T-Jet 16V | 1.4 | 99 | 08- | | 4 | 0,8 | IKR9F8 | 5756 | | IKR9F8 | 5756 |
| 500 Abarth | 1.4 | 103 | 06.10- | | 4 | 0,8 | IKR9F8 | 5756 | | IKR9F8 | 5756 |
| Grande Punto 1,4 T-Jet 16V 180CV SS | 1.4 | 132 | 09.09- | | 4 | 0,8 | IKR9F8 | 5756 | | IKR9F8 | 5756 |
| Grande Punto 1.4 T-Jet 16V | 1.4 | 114 | 07- | 199A8000 | 4 | 0,8 | IKR9F8 | 5756 | | IKR9F8 | 5756 |
| Punto EVO Abarth | 1.4 | 120 | 06.10- | | 4 | 0,8 | IKR9F8 | 5756 | | IKR9F8 | 5756 |

ACURA

| | | | | | | | | | | | |
|-----------|-----|-----|-------------|-------|---|-----|------------|------|----|------------|------|
| Legend LX | 2.5 | 122 | 01.86-12.87 | C25A1 | 6 | 1,1 | BCPR6E-11 | 3132 | 11 | LPG 3 | 1498 |
| RSX | 2.0 | 147 | 02-03 | K20A2 | 4 | 1,1 | IFR7G-11KS | 7746 | | IFR7G-11KS | 7746 |
| RSX | 2.0 | | 02-02 | K20A3 | 4 | 1,1 | IZFR6K11 | 6994 | | IZFR6K11 | 6994 |
| SLX | 3.2 | | 96-97 | 6VD1 | 6 | 1,1 | PFR5G-11 | 2647 | | PFR6G-11 | 5555 |
| SLX | 3.5 | | 98- | 6VE1 | 6 | 1,1 | PFR5G-11 | 2647 | | PFR6G-11 | 5555 |

ALFA ROMEO

| | | | | | | | | | | | |
|------------------------------------|-----|-----|-------------|---------------------------------------|---|-----|---------------------|---------------|---|------------|------|
| 10 AR 6, 13 AR 6 D | 2.5 | 53 | 04.85-02.86 | | 4 | █ | Y-208T | 1250 | | | |
| 145 16V T.S. (Brazil) | 2.0 | 110 | 12.96-04.01 | | 4 | | BKR6EKPA + PMR7A | 2513+ 4259 | | | |
| 145 i 2.0 16V T.S. | 2.0 | 114 | 03.98-04.01 | AR32.301 | 4 | | BKR6EKPA + PMR7A | 2513+ 4259 | | | |
| 145 i 16V T.S. Quadrifoglio | 2.0 | 110 | 10.95-04.01 | AR67.204 | 4 | | BKR6EKPA + PMR7A | 2513+ 4259 | | | |
| 145 i 16V Twin Spark | 1.8 | 106 | 03.98-12.01 | AR32.201 | 4 | | BKR6EKPA + PMR7A | 2513+ 4259 | | | |
| 145 i 16V Twin Spark L | 1.6 | 88 | 04.96-12.01 | AR67.601 | 4 | | BKR6EKPA + PMR7A | 2513+ 4259 | | | |
| 145 i 16V Twin Spark;L; Junior | 1.4 | 76 | 04.97-12.01 | AR33.503 | 4 | | BKR6EKPA + PMR7A | 2513+ 4259 | | | |
| 145 i Twin Spark 16V- L | 1.8 | 103 | 12.96-03.98 | AR67.106 | 4 | | BKR6EKPA + PMR7A | 2513+ 4259 | | | |
| 145 i.e 16V | 1.7 | 95 | 08.94-11.96 | AR33.401 | 4 | 0,9 | PFR6B | 3500 | | PFR7B | 4853 |
| 145 i.e L | 1.4 | 66 | 08.94-11.96 | AR33.501 | 4 | 0,7 | BP6ES | 7811 | 4 | LPG 2 | 1497 |
| 145 i.e L | 1.6 | 76 | 08.94-11.96 | AR33.201 | 4 | 0,7 | BP6ES | 7811 | 4 | LPG 2 | 1497 |
| 145 JTD | 1.9 | 77 | 11.99-01.01 | AR32.302 dal n. | | | | | | | |
| 145 JTD | 1.9 | 77 | 02.99-10.99 | AR32.302 fino a n. motore →1716458 | 4 | █ | Y-534J | 3413 | | D-POWER 36 | 3413 |
| 145 TD | 1.9 | 66 | 10.96-09.97 | AR33.601 | 4 | █ | Y-747U | 4694 | | D-POWER 26 | 4694 |
| 145 TD | 1.9 | 66 | 04.94-09.96 | AR67.501 | 4 | █ | Y-922R | 4356 | | D-POWER 1 | 7906 |
| 146 | 1.7 | 78 | 08.98-04.99 | AR32.201 | 4 | | BKR6EKPA + PMR7A | 2513+ 4259 | | | |
| 146 1.4i 16V Twin Spark; L; Junior | 1.4 | 76 | 04.98-12.01 | AR33.503 | 4 | | BKR6EKPA + PMR7A | 2513+ 4259 | | | |
| 146 i 2.0 16V T.S. | 2.0 | 114 | 03.98-12.01 | AR32.301 | 4 | | BKR6EKPA + PMR7A | 2513+ 4259 | | | |
| 146 i Twin Spark 16V; L | 1.4 | 76 | 02.97-03.98 | AR33.503 | 4 | | BKR6EKPA + PMR7A | 2513+ 4259 | | | |
| 146 i 16V Twin Spark L | 1.6 | 88 | 04.96-12.01 | AR67.601 | 4 | | BKR6EKPA + PMR7A | 2513+ 4259 | | | |
| 146 i 16V Twin Spark L | 1.8 | 103 | 02.97-12.01 | AR67.106 | 4 | | BKR6EKPA + PMR7A | 2513+ 4259 | | | |
| 146 i 16V Twin Spark | 1.8 | 106 | 12.96-04.01 | AR32.201 | 4 | | BKR6EKPA + PMR7A | 2513+ 4259 | | | |



ℓ kW

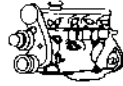

Cyl.

Order-
No.VLINE
No.LPG/CNG
D-PowerOrder-
No.**ALFA ROMEO**

| | | | | | | | | | | | |
|---------------------------|-----|-----|---------------|---------------------------------------|---|-----|----------------------|---------------|----|------------|------|
| 146 i. Twin Spark 16V- ti | 2.0 | 110 | 02.96 - 04.01 | AR67.204 | 4 | | BKR6EKPA + PMR7A | 2513+ 4259 | | | |
| 146 i.e 16V | 1.7 | 95 | 08.94 - 02.97 | AR33.401 | 4 | 0,9 | PFR6B | 3500 | | PFR7B | 4853 |
| 146 i.e L | 1.6 | 76 | 07.94 - 12.97 | AR33.201 | 4 | 0,7 | BP6ES | 7811 | 4 | LPG 2 | 1497 |
| 146 i.e- L | 1.4 | 66 | 08.94 - 02.97 | AR33.501 | 4 | 0,7 | BP6ES | 7811 | 4 | LPG 2 | 1497 |
| 146 i.e. | 1.3 | 66 | 07.95 - 11.97 | AR33.201 | 4 | 0,7 | BP6ES | 7811 | 4 | LPG 2 | 1497 |
| 146 JTD | 1.9 | 77 | 11.99 - 01.01 | AR32.302 dal n. motore 1716459 → | 4 | | Y-534J | 3413 | | D-POWER 36 | 3413 |
| 146 JTD | 1.9 | 77 | 02.99 - 10.99 | AR32.302 fino a n. motore →1716458 | 4 | | Y-747U | 4694 | | D-POWER 26 | 4694 |
| 146 T.S. | 1.4 | 76 | 11.96 - 12.01 | AR33.503 | 4 | | BKR6EKPA + PMR7A | 2513+ 4259 | | | |
| 146 TD | 1.9 | 66 | 10.96 - 09.97 | AR33.601 | 4 | | Y-922R | 4356 | | D-POWER 1 | 7906 |
| 146 TD | 1.9 | 66 | 02.95 - 09.96 | AR67 501 | 4 | | Y-922R | 4356 | | D-POWER 1 | 7906 |
| 147 1.6 T.S. 16V | 1.6 | 88 | 10.00 - | AR32.104 | 4 | | BKR6EKPA + PMR7A | 2513+ 4259 | | | |
| 147 1.6 T.S. 16V 105CV | 1.6 | 76 | 10.00 - | AR37.203 | 4 | | BKUR6ETB + CR7EKC | 6992+ 7004 | | | |
| 147 2.0 T.S. 16V | 2.0 | 110 | 10.00 - | AR 32310 | 4 | | BKR6EKPA + PMR7A | 2513+ 4259 | | | |
| 147 GTA | 3.2 | 184 | 11.02 - 05.06 | 932A.000 | 6 | 0,9 | PFR6B | 3500 | | PFR7B | 4853 |
| 147 JTD | 1.9 | 74 | 11.00 - 05.03 | 182B9000 | 4 | | Y-534J | 3413 | | D-POWER 36 | 3413 |
| 147 JTD | 1.9 | 85 | 06.03 - 06.05 | 937A2000 | 4 | | Y-534J | 3413 | | D-POWER 36 | 3413 |
| 147 JTD 16V | 1.9 | 103 | 11.03 - | 192A5000 | 4 | | YE07 | 6092 | | | |
| 155 i - Turbo- Turbo 4x4 | 2.0 | 137 | 08.92 - 04.98 | AR67.203 | 4 | | BP6ET | 1263 | | LPG 2 | 1497 |
| 155 i T.S. | 1.7 | 86 | 02.92 - 04.93 | AR67.103 | 4 | 0,7 | BCP6ES | 4930 | 17 | LPG 3 | 1498 |
| 155 i. | 2.5 | 120 | 02.92 - | AR67.301 | 6 | 0,8 | BPR7ES | 2023 | 19 | BPR8EIX | 6684 |
| 155 i. V6 | 2.5 | 120 | 02.92 - 04.95 | AR67.301 | 6 | 0,8 | BPR7ES | 2023 | 19 | BPR8EIX | 6684 |
| 155 i. V6 | 2.5 | 120 | 05.95 - 02.97 | AR67.301 | 6 | 0,7 | BP6ES | 7811 | 4 | LPG 2 | 1497 |
| 155 i.16V T.S. | 2.0 | 110 | 06.94 - 01.98 | AR67.204 | 4 | | BKR6EKPA + PMR7A | 2513+ 4259 | | | |
| 155 i.T.S. | 1.7 | 95 | 05.93 - 07.96 | AR67.105 | 4 | 0,7 | BCP6ES | 4930 | 17 | LPG 3 | 1498 |
| 155 i.T.S. | 1.8 | 93 | 04.94 - 07.96 | AR67.101-67.102 | 4 | 0,7 | BCP6ES | 4930 | 17 | LPG 3 | 1498 |
| 155 i.T.S.L | 2.0 | 104 | 06.94 - | | 4 | 0,7 | BCP6ES | 4930 | 17 | LPG 3 | 1498 |
| 155 i.T.S.L | 2.0 | 104 | 02.92 - 02.95 | AR67.201-67.202 | 4 | 0,7 | BCP6ES | 4930 | 17 | LPG 3 | 1498 |
| 155 i.Twin Spark | 1.8 | 93 | 02.92 - 07.96 | AR67.102 | 4 | 0,7 | BCP6ES | 4930 | 17 | LPG 3 | 1498 |
| 155 i.Twin Spark | 2.0 | 106 | 02.92 - 02.95 | AR67.202 | 4 | 0,7 | BCP6ES | 4930 | 17 | LPG 3 | 1498 |
| 155 TD | 1.9 | 68 | 04.93 - 04.96 | AR67.501 | 4 | | Y-924J | 7906 | | D-POWER 1 | 7906 |
| 155 TD | 2.0 | 66 | 08.93 - 04.96 | AR67.502 | 4 | | Y-922R | 4356 | | D-POWER 1 | 7906 |
| 155 TD | 2.5 | 92 | 04.93 - 04.95 | VM 425 CLIEA | 4 | | Y-922R | 4356 | | D-POWER 1 | 7906 |
| 155 TD | 2.5 | 92 | 05.95 - 10.97 | VM 425 CLIEA | 4 | | Y-741U | 6943 | | D-POWER 20 | 6943 |
| 156 16V T.S | 2.0 | 114 | 12.97 - 12.02 | AR32.301 | 4 | | BKR6EKPA + PMR7A | 2513+ 4259 | | | |
| 156 16V T.S. | 1.6 | 88 | 12.97 - 05.06 | AR32.101 | 4 | | BKR6EKPA + PMR7A | 2513+ 4259 | | | |
| 156 16V T.S. | 1.8 | 106 | 12.97 - 05.06 | AR32.201 | 4 | | BKR6EKPA + PMR7A | 2513+ 4259 | | | |
| 156 16V T.S. Selespeed | 2.0 | 114 | 05.99 - 12.02 | AR32.301 | 4 | | BKR6EKPA + PMR7A | 2513+ 4259 | | | |
| 156 24V | 2.5 | 140 | 10.97 - 05.06 | AR32.401 | 6 | 0,9 | PFR6B | 3500 | | PFR7B | 4853 |
| 156 GTA | 3.2 | 184 | 11.02 - 05.06 | 932A.000 | 6 | 0,9 | PFR6B | 3500 | | PFR7B | 4853 |
| 156 JTD | 1.9 | 77 | 10.97 - 09.00 | AR32.302 | 4 | | Y-747U | 4694 | | D-POWER 26 | 4694 |



ℓ kW



Cyl.

Order-
No. No.LPG/CNG
D-PowerOrder-
No.**ALFA ROMEO**

| | | | | | | | | | | |
|--------------------------------------|-----|-----|---------------|--------------------|---|------------|-------|----|------------|------|
| 156 JTD | 1.9 | 81 | 10.00 - 05.01 | AR37.101 | 4 | Y-534J | 3413 | | D-POWER 36 | 3413 |
| 156 JTD | 1.9 | 85 | 05.01 - 05 | 937A2000 | 4 | Y-534J | 3413 | | D-POWER 36 | 3413 |
| 156 JTD | 2.4 | 100 | 10.97 - 09.00 | AR32.501 | 5 | Y-747U | 4694 | | D-POWER 26 | 4694 |
| 156 JTD | 2.4 | 103 | 10.00 - 02.02 | 839A6000 | 5 | Y-534J | 3413 | | D-POWER 36 | 3413 |
| 156 JTD | 2.4 | 110 | 03.02 - 01.04 | 841C000 | 5 | Y-534J | 3413 | | D-POWER 36 | 3413 |
| 156 JTD 16V | 1.9 | 103 | 02 - 04 | 192A5000 | 4 | YE07 | 6092 | | | |
| 156 JTD 16V | 1.9 | 110 | 04 - 06 | 937A5000 | 4 | YE07 | 6092 | | | |
| 156 JTD 20V | 2.4 | 129 | 11.03 - 05.06 | 841G000 | 5 | YE07 | 6092 | | | |
| 156 JTS | 2.0 | 121 | 11.01 - 05.06 | 937A.1000 | 4 | BKR6EKPA | 2513 | | | |
| 159 1.9 JTDm 16V | 1.9 | 110 | 12.05 - | 939A2000 | 4 | YE07 | 6092 | | | |
| 159 1.9 JTS 16V | 1.9 | 118 | 07.05 - | 939A6000 | 4 | FR5CP | 6368 | | | |
| 159 2.2 JTS 16V | 2.2 | 136 | 07.05 - | 939A5000 | 4 | FR5CP | 6368 | | | |
| 159 2.4 JTDm 20V | 2.4 | 147 | 12.05 - 04.07 | 939A3000 | 5 | YE07 | 6092 | | | |
| 164 12V | 3.0 | | 06.87 - 09.93 | 06410, 06412 | 6 | 0,7 B7ES | 1111 | | BR8EIX | 5044 |
| 164 i. | 2.0 | | 03.91 - | | | 0,8 BP7ES | 2412 | | BPR8EIX | 6684 |
| 164 i. Q.4 | 3.0 | 171 | 01.90 - 10.98 | AR64.304 | 6 | 0,9 PFR6B | 3500 | | PFR7B | 4853 |
| 164 i. V6 12V | 3.0 | 138 | 01.90 - 10.98 | AR64.305 | 6 | 0,7 BP6ES | 7811 | 4 | LPG 2 | 1497 |
| 164 i. V6 12V | 3.0 | 155 | 92 - 10.98 | AR66.301 | 6 | 0,9 PFR6B | 3500 | | PFR7B | 4853 |
| 164 i. V6 24V CF2 | 3.0 | 155 | 01.87 - 92 | AR64.301 | 6 | 0,7 PGR6A | 4984 | | PGR7A | 3200 |
| 164 i. V6 24V Super | 3.0 | 155 | 07.94 - 10.98 | AR64.304-64.308 | 6 | 0,9 PFR6B | 3500 | | PFR7B | 4853 |
| 164 i. V6 QV | 3.0 | 169 | - 10.98 | AR16.102 | 6 | 0,7 PGR6A | 4984 | | PGR7A | 3200 |
| 164 i. V6 Super | 3.0 | 132 | 01.96 - | | 6 | 0,7 PGR6A | 4984 | | PGR7A | 3200 |
| 164 i. V6 turbo Super | 2.0 | 148 | 03.91 - 10.98 | AR64.102 | 6 | 0,8 BP7ES | 2412 | | BPR8EIX | 6684 |
| 164 i.e. Turbo | 2.0 | 126 | 01.88 - 09.92 | AR064.76 | 4 | 0,8 BPR7ES | 2023 | 19 | BPR8EIX | 6684 |
| 164 i.T.S Super / Super L | 2.0 | 106 | 07.94 - 10.98 | AR67.201-67202 | 4 | 0,7 BCP6ES | 4930 | 17 | LPG 3 | 1498 |
| 164 i.T.S. | 2.0 | 102 | 06.87 - 09.92 | AR064.16Cat-064.20 | 4 | 0,7 BCP6ES | 4930 | 17 | LPG 3 | 1498 |
| 164 TD | 2.5 | 85 | 06.87 - 08.92 | VM 84 A | 4 | Y-909R | 4602 | | | |
| 164 TD | 2.5 | 92 | 05.95 - 10.98 | VM 425 SLIRA | 4 | Y-741U | 6943 | | D-POWER 20 | 6943 |
| 164 TD Super | 2.5 | 92 | 09.92 - 04.95 | VM 425-SLIRA | 4 | Y-922R | 4356 | | D-POWER 1 | 7906 |
| 166 2.0 T.S. 16V | 2.0 | 114 | 11.98 - 06.06 | AR34.103 | 4 | BKR6EKPA + | 2513+ | | | |
| | | | | | | PMR7A | 4259 | | | |
| 166 2.0 TS | 2.0 | 125 | 11.03 - 06.06 | AR36301 | 4 | BKR6EKPA + | 2513+ | | | |
| | | | | | | PMR7A | 4259 | | | |
| 166 2.0 V6 Turbo Super;Prog.Distint. | 2.0 | 151 | 11.98 - 06.06 | AR34.102 | 6 | 0,8 BP6E | 5637 | 4 | BPR6EIX | 6637 |
| 166 2.5 I V6 24V | 2.5 | 140 | 11.98 - 06.06 | AR34.201 | 6 | 0,9 PFR6B | 3500 | | PFR7B | 4853 |
| 166 24V V6 (Brazil) | 2.0 | 151 | 10.98 - 06.06 | | 6 | 0,9 PFR6B | 3500 | | PFR7B | 4853 |
| 166 3.0 I V6 24V | 3.0 | 162 | 11.98 - 06.06 | AR34.301 | 6 | 0,9 PFR6B | 3500 | | PFR7B | 4853 |
| 166 3.2 V6 24V | 3.2 | 176 | 11.03 - 06.06 | 936A6000 | 6 | 0,9 PFR6B | 3500 | | PFR7B | 4853 |
| 166 JTD | 2.4 | 103 | 11.00 - 03.02 | 839A600 | 5 | Y-534J | 3413 | | D-POWER 36 | 3413 |
| 166 JTD | 2.4 | 103 | 10.98 - 10.00 | AR34.202 | 5 | Y-747U | 4694 | | D-POWER 26 | 4694 |
| 166 JTD | 2.4 | 110 | 04.02 - 10.03 | 841C000 | 5 | Y-534J | 3413 | | D-POWER 36 | 3413 |
| 166 JTD 20V M-JET | 2.4 | 132 | 07.06 - | 936B000 | 5 | YE07 | 6092 | | | |
| 30 AR 8, 35 AR 8, 40 AR 8 D | 2.5 | 53 | 02.80 - 06.82 | Sofim 8140.61.200 | 4 | Y-208T | 1250 | | | |
| 30 AR 8, 35 AR 8, 40 AR 8 D | 2.5 | 53 | 07.82 - 09.83 | Sofim 8140.61.200 | 4 | Y-208T | 1250 | | | |
| 30 AR 8, 35 AR 8, 40 AR 8 D | 2.5 | 53 | 10.83 - 12.89 | Sofim 8140.61.200 | 4 | Y-908R | 4585 | | D-POWER 1 | 7906 |
| 32 AR 8 D | 2.5 | 53 | 02.80 - 09.80 | Sofim 8140.61.200 | 4 | Y-208T | 1250 | | | |
| 33 - 1.3 L | 1.3 | | 87 - 01.94 | AR305.02-86-87 | 4 | 0,7 BP6ES | 7811 | 4 | LPG 2 | 1497 |
| 33 - 1.5 L | 1.5 | 77 | 84 - 93 | AR307.34-305.88 | 4 | 0,7 BP6ES | 7811 | 4 | LPG 2 | 1497 |
| 33 i.e | 1.3 | 65 | 02.94 - 10.94 | AR307.32 | 4 | 0,7 BP6ES | 7811 | 4 | LPG 2 | 1497 |
| 33 i.e Sport Wagon | 1.3 | 65 | 02.94 - 10.94 | AR307.32-301.68 | 4 | 0,7 BP6ES | 7811 | 4 | LPG 2 | 1497 |
| 33 i.e. | 1.4 | 66 | 01.92 - 12.93 | AR307.53 | 4 | 0,7 BP6ES | 7811 | 4 | LPG 2 | 1497 |
| 33 i.e. - 1.7 L | 1.7 | 85 | 88 - 93 | AR305.50 | 4 | 0,7 BP6ES | 7811 | 4 | LPG 2 | 1497 |



ℓ kW

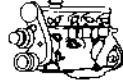

Cyl.

Order-
No.VLINE
No.LPG/CNG
D-PowerOrder-
No.**ALFA ROMEO**

| | | | | | | | | | | | |
|------------------------------|-----|-----|---------------|----------------------|---|-----|---------------------|---------------|----|---------|------|
| 33 i.e.- 1.7 Ltr.16V | 1.7 | 95 | 01.88 - 12.93 | AR307.36-37 | 4 | 0,9 | PFR6B | 3500 | | PFR7B | 4853 |
| 33 i.e. all 1.7 Ltr.cat. | 1.7 | 77 | 90 - 93 | AR307.46-47 | 4 | 0,9 | PFR6B | 3500 | | PFR7B | 4853 |
| 33 i.e.; Cat. | 1.5 | 74 | 12.90 - 93 | AR307.51 | 4 | 0,7 | BP6ES | 7811 | 4 | LPG 2 | 1497 |
| 33 TD | 1.8 | 55 | 09.86 - 03.94 | | 4 | █ | Y-909R | 4602 | | | |
| 33 TD | 1.8 | 62 | 02.90 - 03.94 | VM 82 A | 4 | █ | Y-909R | 4602 | | | |
| 33 TD | 1.8 | 62 | 09.86 - 03.94 | VM HR-392 | 3 | █ | Y-909R | 4602 | | | |
| 33 TD Sport Wagon | 1.8 | 62 | 01.90 - 03.94 | VM 96 A | 4 | █ | Y-909R | 4602 | | | |
| 6 | 2.0 | 100 | 09.83 - 12.86 | AR019.32 | 4 | 0,8 | BP7ES | 2412 | | BPR8EIX | 6684 |
| 6 / I Q.O. | 2.5 | 117 | 09.83 - 12.86 | AR019.28 | 6 | 0,8 | BP7ES | 2412 | | BPR8EIX | 6684 |
| 6 TD | 2.5 | 77 | 06.83 - 02.87 | VM HR 588HT | 6 | █ | Y-909R | 4602 | | | |
| 75 | 1.6 | 81 | 05.85 - 09.89 | AR061.00 | 4 | 0,7 | BP6ES | 7811 | 4 | LPG 2 | 1497 |
| 75 | 1.8 | 89 | 05.85 - 09.89 | AR062.02 | 4 | 0,7 | BP6ES | 7811 | 4 | LPG 2 | 1497 |
| 75 | 2.0 | 94 | 05.85 - 10.88 | AR062.12 | 4 | 0,7 | BP6ES | 7811 | 4 | LPG 2 | 1497 |
| 75 i. Turbo | 1.8 | 121 | 12.86 - 12.87 | AR061.58 | 4 | 0,7 | BP6ES | 7811 | 4 | LPG 2 | 1497 |
| 75 i. V6 | 2.5 | 110 | 09.85 - 02.92 | AR016.46-019.11 Cat. | 6 | 0,8 | BP7ES | 2412 | | BPR8EIX | 6684 |
| 75 i. V6 | 3.0 | 133 | 01.87 - 02.92 | AR061.20-061.24 Cat. | 6 | 0,7 | BP6ES | 7811 | 4 | LPG 2 | 1497 |
| 75 i. V6 | 3.0 | 139 | 02.90 - 02.92 | AR061.503 | 6 | 0,7 | PGR6A | 4984 | | PGR7A | 3200 |
| 75 i.Twin Spark | 2.0 | 106 | 01.87 - 02.92 | AR061.66 Cat.-062.24 | 4 | 0,7 | BCP6ES | 4930 | 17 | LPG 3 | 1498 |
| 75 TD | 2.0 | 70 | 05.85 - 02.92 | VM 80 A | 4 | █ | Y-909R | 4602 | | | |
| 75 TD | 2.4 | 81 | 10.88 - 02.92 | VM 81 A | 4 | █ | Y-909R | 4602 | | | |
| Alfa 90 / i. Super | 2.0 | 94 | 10.84 - 01.87 | AR017.13 | 4 | 0,7 | BP6ES | 7811 | 4 | LPG 2 | 1497 |
| Alfa 90 i. Super | 2.5 | 110 | 10.84 - 12.90 | AR016.46-019.11 cat | 6 | 0,7 | B7ES | 1111 | | BR8EIX | 5044 |
| Alfa 90 i. V6 Super | 2.0 | 97 | 05.85 - 01.87 | AR062.10/12 | 6 | 0,8 | BP7ES | 2412 | | BPR8EIX | 6684 |
| Alfa 90 Super | 1.8 | 89 | 10.84 - 01.87 | AR062.02 | 4 | 0,7 | BP6ES | 7811 | 4 | LPG 2 | 1497 |
| Alfa 90 TD | 2.4 | 81 | 10.84 - 01.87 | VM 81 A | 4 | █ | Y-909R | 4602 | | | |
| Alfasud / SC | 1.2 | 50 | 03.80 - 06.83 | AR301.04 | 4 | 0,7 | BP6ES | 7811 | 4 | LPG 2 | 1497 |
| Alfasud TI | 1.3 | 63 | 03.80 - 12.84 | AR301.68 | 4 | 0,7 | BP6ES | 7811 | 4 | LPG 2 | 1497 |
| Alfasud TI Q.V. / Q.O. | 1.5 | 70 | 03.80 - 12.84 | AR301.28 | 4 | 0,7 | BP6ES | 7811 | 4 | LPG 2 | 1497 |
| Alfetta TD | 2.4 | 69 | 04.83 - 12.84 | VM 4 HT 2.4 | 4 | █ | Y-909R | 4602 | | | |
| Arna L / SL | 1.2 | 44 | 09.83 - 12.86 | AR305.00-310.00 | 4 | 0,7 | BP6ES | 7811 | 4 | LPG 2 | 1497 |
| Arna TI | 1.3 | 63 | 09.83 - 12.86 | AR310.10 | 4 | 0,7 | BP6ES | 7811 | 4 | LPG 2 | 1497 |
| Brera 2.2 JTS | 2.2 | 136 | 09.05 - | 939A5000 | 4 | | FR5CP | 6368 | | | |
| Brera 2.4 JTDm 20V 200CV | 2.4 | 154 | 01.06 - | 939A3000 | 5 | █ | YE07 | 6092 | | | |
| Giulietta 1,4 Turbo | 1.4 | 88 | 03.10 - | | 4 | 0,8 | IKR9F8 | 5756 | | IKR9F8 | 5756 |
| Giulietta 1.4 Turbo MultiAir | 1.4 | 125 | 03.10 - | | 4 | 0,8 | IKR9F8 | 5756 | | IKR9F8 | 5756 |
| Giulietta TD | 2.0 | 61 | 03.83 - 04.85 | VM 4 HT | 4 | █ | Y-909R | 4602 | | | |
| GT | 3.2 | 176 | 12.03 - 12.04 | 936A.6000 | 6 | 0,9 | PFR6B | 3500 | | PFR7B | 4853 |
| GT 1.8 16V TS | 1.8 | 103 | 12.03 - | AR32205 | 4 | | BKR6EKPA + PMR7A | 2513+ 4259 | | | |
| GT 1.9 JTDm 16V | 1.9 | 110 | 12.03 - | 937A5000 | 4 | █ | YE07 | 6092 | | | |
| GT 2.0 JTS | 2.0 | 121 | 12.03 - | 937A1000 | 4 | | BKR6EKPA | 2513 | | | |
| GTV 2.0 L V6 turbo L | 2.0 | 148 | 06.98 - 12.99 | AR16.202 | 6 | 0,9 | BPR6E | 6464 | 2 | LPG 2 | 1497 |
| GTV V6 Turbo | 2.0 | 147 | 04.95 - 05.98 | AR16.202 | 6 | 0,8 | BP7ES | 2412 | | BPR8EIX | 6684 |
| GTV V6 12V | 2.0 | 151 | 09.97 - 12.00 | | 6 | 0,8 | BPR7ES | 2023 | 19 | BPR8EIX | 6684 |
| GTV V6 24V | 3.0 | 162 | 02.97 - 05.98 | AR67.601 | 6 | 0,9 | PFR6B | 3500 | | PFR7B | 4853 |
| GTV V6 24V | 3.2 | 176 | 06.03 - | 936A.6000 | 6 | 0,9 | PFR6B | 3500 | | PFR7B | 4853 |
| GTV V6 24V- L | 3.0 | 160 | 11.96 - 12.00 | AR16.102 | 6 | 0,9 | PFR6B | 3500 | | PFR7B | 4853 |
| GTV 2.0 JTS 16V | 2.0 | 121 | 06.03 - | 937A.1000 | 4 | | BKR6EKPA | 2513 | | | |
| GTV 2.0 L Twin Spark -16V | 2.0 | 110 | 06.98 - | AR32.301 | 4 | | BKR6EKPA + PMR7A | 2513+ 4259 | | | |
| GTV i 16V Twin Spark | 1.8 | 106 | 06.98 - 06.02 | AR32.201 | 4 | | BKR6EKPA + PMR7A | 2513+ 4259 | | | |



l kW



Cyl.

Order-
No. No.LPG/CNG
D-PowerOrder-
No.**ALFA ROMEO**

| | | | | | | | | | | | |
|--------------------------------|-----|-----|---------------|---------------------|---|-----|---------------------|---------------|---|------------|-------|
| GTV T.S. 16V | 2.0 | 110 | 04.95 - 05.98 | AR16.201 | 4 | | BKR6EKPA + PMR7A | 2513+ 4259 | | | |
| MITO 1,4 Turbo 170cv Mair Q.V. | 1.4 | 125 | 12.09 - | | 4 | 0,8 | IKR9F8 | 5756 | | IKR9F8 | 5756 |
| MITO 1,4 Turbo Multiair 135 CV | 1.4 | 99 | 08.09 - | 955A2000 | 4 | 0,8 | IKR9F8 | 5756 | | IKR9F8 | 5756 |
| MITO 1.3 JTDm 90CV | 1.3 | 66 | 10.08 - | | 4 | | Y8003J | 97256 | | D-POWER 62 | 97256 |
| MITO 1.4 78CV JUNIOR | 1.4 | 58 | 08 - | 955A1000 | 4 | 1,0 | ZKR7A-10 | 1691 | | ZKR7A-10 | 1691 |
| MITO 1.4 Multiair 105 CV | 1.4 | 77 | 10.09 - | 955A6000 | 4 | 1,0 | DCPR7E-N-10 | 4983 | | | |
| MITO 1.4 Turbo 120CV | 1.4 | 88 | 08 - | | 4 | 0,8 | IKR9F8 | 5756 | | IKR9F8 | 5756 |
| MITO 1.4 Turbo 155CV | 1.4 | 114 | 08 - | 199A8000 | 4 | 0,8 | IKR9F8 | 5756 | | IKR9F8 | 5756 |
| Spider 16V T.S. | 1.8 | 106 | 05.98 - 03.01 | AR32.201 | 4 | | BKR6EKPA + PMR7A | 2513+ 4259 | | | |
| Spider 16V T.S. | 2.0 | 110 | 04.95 - 05.98 | AR16.201 | 4 | | BKR6EKPA + PMR7A | 2513+ 4259 | | | |
| Spider 16V T.S. | 2.0 | 114 | 06.98 - | AR32.301 | 4 | | BKR6EKPA + PMR7A | 2513+ 4259 | | | |
| Spider 2.0 JTS 16V | 2.0 | 121 | 06.03 - | 937A.1000 | 4 | | BKR6EKPA | 2513 | | | |
| Spider 2.2 JTS | 2.2 | 136 | 01.06 - | 939A5000 | 4 | | FR5CP | 6368 | | | |
| Spider 2.4 JTDm 200CV | 2.4 | 147 | 09.06 - | 939A3000 | 5 | | YE07 | 6092 | | | |
| Spider 3.0 V6 24V | 3.0 | 165 | 06.98 - 04 | AR16.102 | 6 | 0,9 | PFR6B | 3500 | | PFR7B | 4853 |
| Spider 3.2 V6 24V | 3.2 | 176 | 06.03 - | 936A6000 | 6 | 0,9 | PFR6B | 3500 | | PFR7B | 4853 |
| Spider i V6 12V | 3.0 | 140 | 04.95 - 05.98 | AR16.101-16.199 | 6 | 0,8 | BPR6ES | 7822 | 2 | LPG 2 | 1497 |
| Spider i V6 turbo | 2.0 | 147 | 06.98 - 12.99 | AR16.202 | 6 | 0,9 | BPR6E | 6464 | 2 | LPG 2 | 1497 |
| Spider i. | 2.0 | 86 | 01.90 - 12.94 | AR015.44-88-90 Cat. | 4 | 0,7 | BP6ES | 7811 | 4 | LPG 2 | 1497 |
| Sprint Q.V. | 1.5 | 70 | 01.83 - 12.89 | AR301.28-46-98 | 4 | 0,7 | BP6ES | 7811 | 4 | LPG 2 | 1497 |
| Sprint Q.V. | 1.7 | 87 | 10.87 - 12.89 | AR305.50 | 4 | 0,7 | BP6ES | 7811 | 4 | LPG 2 | 1497 |
| Sprint Veloce | 1.3 | 64 | 01.90 - | AR301.68 | 4 | 0,7 | BP6ES | 7811 | 4 | LPG 2 | 1497 |
| SZ V6 / RZ V6 | 3.0 | 152 | 03.90 - 05.96 | AR64.304 | 6 | 0,7 | PGR6A | 4984 | | PGR7A | 3200 |
| 155 i.16 V T.S. | 1.6 | 88 | 07.96 - 01.98 | AR67.601 | 4 | | BKR6EKPA + PMR7A | 2513+ 4259 | | | |
| 155 i.16 V T.S. | 1.8 | 103 | 05.96 - 01.98 | AR67.106 | 4 | | BKR6EKPA + PMR7A | 2513+ 4259 | | | |

ALPINA

| | | | | | | | | | | | | |
|----------|-------------|-----|-----|---------------|-------------|---|-----|----------|------|----|-------|------|
| B 3 | E36 | 3.0 | 184 | 04.93 - 03.96 | M50B30 | 6 | | BKR6EK | 2288 | 20 | LPG 1 | 1496 |
| B 3 | E36 | 3.2 | 195 | 04.96 - 03.99 | S52B32 | 6 | | BKR6EK | 2288 | 20 | LPG 1 | 1496 |
| B 3 3.2 | E36 Cabrio | 3.2 | 195 | 04.96 - 03.99 | S52B32 | 6 | | BKR6EK | 2288 | 20 | LPG 1 | 1496 |
| B 3 3.3 | E46 | 3.3 | 206 | 03.99 - 01.05 | S52B33 | 6 | | BKR6EQUP | 3199 | 30 | LPG 1 | 1496 |
| B 3 S | E46 | 3.3 | 224 | 08.02 - 01.06 | S52B33 | 6 | | BKR6EQUP | 3199 | 30 | LPG 1 | 1496 |
| B 5 | E60 | 4.4 | 368 | 03.05 - | S62B44 H1/2 | 8 | | PFR7B | 4853 | | PFR8B | 2781 |
| B 5 S | E60 | 4.4 | 390 | 07 - | S62B44 H1/2 | 8 | | PFR7B | 4853 | | PFR8B | 2781 |
| B 6 | E64 Cabrio | 4.4 | 368 | 10.05 - | S62B44 H1/2 | 8 | | PFR7B | 4853 | | PFR8B | 2781 |
| B 6 S | E64 Cabrio | 4.4 | 390 | 07 - | S62B44 H1/2 | 8 | | PFR7B | 4853 | | PFR8B | 2781 |
| B 7 | E65 | 4.4 | 368 | 03.05 - | S62B44 H1/2 | 8 | | PFR7B | 4853 | | PFR8B | 2781 |
| B 8 | E36 | 4.6 | 245 | 01.95 - 11.98 | M62B46 | 8 | | BKR6EK | 2288 | 20 | LPG 1 | 1496 |
| B 10 3.2 | E39 | 3.2 | 191 | 08.97 - 12.98 | S52B32 | 6 | | BKR6EK | 2288 | 20 | LPG 1 | 1496 |
| B 10 3.3 | E39 | 3.3 | 206 | 02.99 - 10.03 | S52B33 | 6 | | BKR6EQUP | 3199 | 30 | LPG 1 | 1496 |
| B 10 3.5 | E34 | 3.5 | 187 | 04.88 - 12.92 | B11/3 | 6 | 0,8 | BPR6ES | 7822 | 2 | LPG 2 | 1497 |
| B 10 3.5 | E34 Biturbo | 3.5 | 265 | 08.89 - 03.94 | B7/5 | 6 | 0,8 | BPR6ES | 7822 | 2 | LPG 2 | 1497 |
| B 10 4.0 | E34 | 4.0 | 232 | 04.93 - 08.95 | F1 | 8 | | BKR6EQUP | 3199 | 30 | LPG 1 | 1496 |
| B 10 4.6 | E34 | 4.6 | 250 | 03.94 - 04.96 | F2 | 8 | | BKR6EQUP | 3199 | 30 | LPG 1 | 1496 |
| B 10 V8 | E39 | 4.6 | 250 | 12.96 - 10.98 | M62B46 | 8 | | BKR6EK | 2288 | 20 | LPG 1 | 1496 |
| B 10 V8 | E39 | 4.6 | 255 | 10.98 - 08.00 | M62B46 | 8 | | BKR6EQUP | 3199 | 30 | LPG 1 | 1496 |



ℓ kW



Cyl.

Order-
No.LPG/CNG
D-PowerOrder-
No.**ALPINA**

| | | | | | | | | | | | | |
|-------------|---------------|-----|-----|---------------|-----------|----|---|-----------|------|----|------------|------|
| B 10 V8S | E39 | 4.8 | 276 | 01.02 - 12.03 | M62B48 | 8 | | BKR6EQUIP | 3199 | 30 | LPG 1 | 1496 |
| B 12 | E38 5.7 E-Kat | 5.7 | 285 | 12.95 - 09.98 | M73B57 | 12 | | BKR6EK | 2288 | 20 | LPG 1 | 1496 |
| B 12 | E38 6.0 E-Kat | 6.0 | 316 | 06.99 - 07.01 | M73B60 | 12 | | BKR6EQUIP | 3199 | 30 | LPG 1 | 1496 |
| D 3 | E90 | 2.0 | 147 | 02.07 - | N47D20 L1 | 4 | ■ | Y-547AS | 5968 | | D-POWER 47 | 5968 |
| Roadster S | E85 | 3.4 | 221 | 07.03 - 12.05 | E5/2 | 6 | | BKR6EQUIP | 3199 | 30 | LPG 1 | 1496 |
| Roadster V8 | E52 | 4.8 | 280 | 06.02 - 10.03 | S62 B48 | 8 | | BKR6EQUIP | 3199 | 30 | LPG 1 | 1496 |

ALPINE

| | | | | | | | | | | | | |
|---------------------------|--|-----|--|--|---------------|---|------|---------|------|--|-------|------|
| A610 V6 GT | | 2.9 | | | Z6W 700 - 702 | 6 | 0,6 | BU6EFSZ | 3488 | | | |
| A610 V6 GT Turbo, Le Mans | | 2.5 | | | Z7U 730-734 | 6 | 0,65 | BP7EFVX | 3344 | | | |
| A610 V6 Turbo | | 3.0 | | | Z7X 744 | 6 | | BKUR7ET | 7873 | | PFR7Q | 7963 |

ARO

| | | | | | | | | | | | | |
|----------|--|-----|----|------|-------|---|-----|--------|------|--|-------|------|
| Spartana | | 1.2 | 40 | 97 - | C3GD7 | 4 | 0,9 | BP5ESZ | 4691 | | LPG 2 | 1497 |
|----------|--|-----|----|------|-------|---|-----|--------|------|--|-------|------|

ASIA MOTORS

| | | | | | | | | | | | | |
|--------|--|-----|----|---------------|----|---|-----|--------|------|---|-------|------|
| Rocsta | | 1.8 | 57 | 02.94 - 12.97 | F8 | 4 | 0,9 | BPR5ES | 7422 | 6 | LPG 2 | 1497 |
| Rocsta | | 2.2 | | 03.94 - 12.97 | R2 | 4 | ■ | Y-107R | 1229 | | | |

ASTON MARTIN

| | | | | | | | | | | | | |
|----------------------------|--|-----|-----|---------------|--------------------|----|-----|----------|------|----|----------|------|
| 48V V12 | | 6.0 | 420 | 04.00 - | | 12 | 1,0 | PTR5D-10 | 3784 | 31 | LPG 5 | 1516 |
| DB7 | | 3.2 | 250 | 09.94 - 06.99 | DOHC | 6 | 0,8 | BCPR7ES | 3330 | | BCPR7EIX | 5690 |
| DB7 | | 5.9 | | 07.99 - 11.00 | DOHC | 12 | 1,3 | PTR6D-13 | 5598 | | LPG 5 | 1516 |
| DB7 | | 5.9 | | 11.00 - | DOHC | 12 | 1,3 | PTR5D-13 | 6644 | | | |
| Lagonda | | 5.3 | | 01.86 - 06.90 | | 8 | 0,9 | BPR6EY | 6427 | | LPG 2 | 1497 |
| Turbo 24V Coupé, Cabriolet | | 3.2 | 246 | 95 - | | 6 | 0,7 | BCPR7ES | 3330 | | BCPR7EIX | 5690 |
| V8 / Vantage | | 5.3 | | 01.87 - 12.89 | V5805743X 9,25 | 8 | 0,9 | BPR8ES | 3923 | | | |
| V8 / Volante | | 5.3 | | 01.87 - 12.89 | V5805743x 9,25 | 8 | 0,9 | BPR8ES | 3923 | | | |
| Vanquish | | 5.9 | | 06.01 - | AM 702 | 12 | 1,3 | PTR6D-13 | 5598 | | LPG 5 | 1516 |
| Vantage | | 5.3 | 410 | 08.93 - | 10.2:1Comp(Zagato) | 8 | 0,8 | BCR8ES | 5430 | | | |
| Vantage | | 5.3 | | 03.86 - 12.89 | 9.3:1 Comp | 8 | 0,9 | BPR7EIX | 4055 | | | |
| Virage / Volante | | 5.3 | | 02.90 - 01.98 | V8 32V | 8 | 0,8 | BCPR6E | 1269 | 12 | LPG 3 | 1498 |

AUDI

| | | | | | | | | | | | | |
|----|--|-----|----|---------------|-----|---|-----|-----------|------|----|-----------|------|
| 80 | | 1.3 | 44 | 08.81 - 03.87 | EP | 4 | | BUR5ET-10 | 7264 | 21 | LPG 2 | 1497 |
| 80 | | 1.6 | 40 | 08.82 - 07.89 | JK | 4 | ■ | Y-918J | 6285 | | D-POWER 2 | 6285 |
| 80 | | 1.6 | 51 | 08.83 - 07.86 | DTA | 4 | | BUR5ET-10 | 7264 | 21 | LPG 2 | 1497 |
| 80 | | 1.6 | 51 | 08.89 - 12.91 | PP | 4 | | BUR5ET-10 | 7264 | 21 | LPG 2 | 1497 |
| 80 | | 1.6 | 51 | 02.86 - 07.86 | RNA | 4 | | BUR5ET-10 | 7264 | 21 | LPG 2 | 1497 |
| 80 | | 1.6 | 52 | 01.92 - 06.94 | ABM | 4 | | BUR5ET | 3377 | 22 | LPG 2 | 1497 |
| 80 | | 1.6 | 53 | 02.86 - 03.87 | SA | 4 | | BUR5ET-10 | 7264 | 21 | LPG 2 | 1497 |
| 80 | | 1.6 | 55 | 08.83 - 03.87 | DT | 4 | | BUR5ET-10 | 7264 | 21 | LPG 2 | 1497 |
| 80 | | 1.6 | 55 | 08.83 - 03.87 | JU | 4 | | BUR5ET-10 | 7264 | 21 | LPG 2 | 1497 |
| 80 | | 1.6 | 55 | 08.83 - 12.91 | RN | 4 | | BUR5ET-10 | 7264 | 21 | LPG 2 | 1497 |
| 80 | | 1.6 | 55 | 08.81 - 07.83 | WV | 4 | 0,7 | BP6ES | 7811 | 4 | LPG 2 | 1497 |
| 80 | | 1.6 | 74 | 06.93 - 07.95 | ADA | 4 | | BUR6ET | 3172 | 1 | LPG 2 | 1497 |
| 80 | | 1.6 | 75 | 08.90 - 05.93 | ABB | 4 | | BUR6ET | 3172 | 1 | LPG 2 | 1497 |
| 80 | | 1.7 | 58 | 08.80 - 07.83 | WT | 4 | 0,7 | BP6ES | 7811 | 4 | LPG 2 | 1497 |
| 80 | | 1.8 | 55 | 10.86 - 10.91 | RU | 4 | | BUR5ET-10 | 7264 | 21 | LPG 2 | 1497 |
| 80 | | 1.8 | 64 | 02.86 - 07.90 | SF | 4 | | BUR6ET | 3172 | 1 | LPG 2 | 1497 |
| 80 | | 1.8 | 66 | 01.83 - 03.87 | DS | 4 | | BUR6ET | 3172 | 1 | LPG 2 | 1497 |
| 80 | | 1.8 | 66 | 08.83 - 12.91 | JN | 4 | | BUR6ET | 3172 | 1 | LPG 2 | 1497 |



ℓ kW

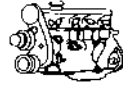

Cyl.

Order-
No. No.LPG/CNG
D-PowerOrder-
No.**AUDI**

| | | | | | | | | | | | |
|------------------|-----|-----|---------------|-----|---|-----|------------|------|----|-----------|------|
| 80 | 1.8 | 66 | 08.84 - 12.91 | NE | 4 | | BUR6ET | 3172 | 1 | LPG 2 | 1497 |
| 80 | 1.8 | 66 | 03.88 - 12.91 | PM | 4 | | BUR6ET | 3172 | 1 | LPG 2 | 1497 |
| 80 | 1.8 | 81 | 03.85 - 03.87 | PV | 4 | | BUR6ET | 3172 | 1 | LPG 2 | 1497 |
| 80 | 1.8 | 82 | 01.83 - 12.91 | DZ | 4 | | BUR6ET | 3172 | 1 | LPG 2 | 1497 |
| 80 | 1.8 | 82 | 06.84 - 03.87 | MU | 4 | | BUR6ET | 3172 | 1 | LPG 2 | 1497 |
| 80 | 1.9 | 47 | 08.89 - 12.91 | 1Y | 4 | ■ | Y-918J | 6285 | | D-POWER 2 | 6285 |
| 80 | 1.9 | 83 | 09.86 - 07.88 | SD | 4 | | BUR6ET | 3172 | 1 | LPG 2 | 1497 |
| 80 | 1.9 | 85 | 08.81 - 07.83 | WN | 4 | 0,8 | BP7ES | 2412 | | BPR8EIX | 6684 |
| 80 | 2.0 | 66 | 09.91 - 06.95 | ABT | 4 | | BUR6ET | 3172 | 1 | LPG 2 | 1497 |
| 80 | 2.0 | 74 | 12.90 - 10.94 | AAE | 4 | | BUR6ET | 3172 | 1 | LPG 2 | 1497 |
| 80 | 2.0 | 79 | 11.93 - 07.95 | ADW | 4 | | BUR6ET | 3172 | 1 | LPG 2 | 1497 |
| 80 | 2.0 | 81 | 09.83 - 07.84 | JL | 4 | | BUR6ET | 3172 | 1 | LPG 2 | 1497 |
| 80 | 2.0 | 83 | 08.88 - 10.90 | 3A | 4 | | BUR6ET | 3172 | 1 | LPG 2 | 1497 |
| 80 | 2.0 | 83 | 08.83 - 03.87 | SK | 4 | | BUR6ET | 3172 | 1 | LPG 2 | 1497 |
| 80 | 2.0 | 85 | 08.90 - 12.91 | AAD | 4 | | BUR6ET | 3172 | 1 | LPG 2 | 1497 |
| 80 | 2.0 | 85 | 09.91 - 07.95 | ABK | 4 | | BUR6ET | 3172 | 1 | LPG 2 | 1497 |
| 80 | 2.0 | 85 | 08.83 - 07.84 | HP | 4 | | BUR6ET | 3172 | 1 | LPG 2 | 1497 |
| 80 | 2.0 | 85 | 08.82 - 07.84 | JS | 5 | | BUR6ET | 3172 | 1 | LPG 2 | 1497 |
| 80 | 2.0 | 101 | 03.90 - 07.92 | 6A | 4 | | BKUR7ET | 7873 | | PFR7Q | 7963 |
| 80 | 2.0 | 103 | 08.92 - 07.95 | ACE | 4 | | BKUR7ET | 7873 | | PFR7Q | 7963 |
| 80 | 2.2 | 96 | 09.81 - 08.84 | KE | 5 | | BUR6ET | 3172 | 1 | LPG 2 | 1497 |
| 80 | 2.2 | 96 | 08.82 - 07.84 | KL | 5 | | BUR6ET | 3172 | 1 | LPG 2 | 1497 |
| 80 | 2.2 | 100 | 08.82 - 07.84 | KK | 5 | 0,8 | BP7ES | 2412 | | BPR8EIX | 6684 |
| 80 | 2.3 | 98 | 09.91 - 11.94 | NG | 5 | | BPR5EKU | 5685 | | LPG 2 | 1497 |
| 80 | 2.6 | 110 | 07.92 - 07.95 | ABC | 6 | | BKUR6ET-10 | 2397 | 24 | LPG 1 | 1496 |
| 80 | 2.8 | 128 | 09.91 - 07.95 | AAH | 6 | | BKUR6ET-10 | 2397 | 24 | LPG 1 | 1496 |
| 80 (China / GUS) | 2.6 | 102 | 05.93 - 07.95 | ACZ | 6 | | BKUR6ET-10 | 2397 | 24 | LPG 1 | 1496 |
| 80 (China) | 1.8 | 66 | 08.83 - 07.88 | JV | 4 | | BUR6ET | 3172 | 1 | LPG 2 | 1497 |
| 80 Avant RS2 | 2.2 | 232 | 03.94 - 07.95 | ADU | 5 | 0,6 | PFR7B | 4853 | | PFR8B | 2781 |
| 80 D,TD | 1.6 | 37 | 08.81 - 08.91 | | 4 | ■ | Y-918J | 6285 | | D-POWER 2 | 6285 |
| 80 D,TD | 1.6 | 40 | 08.80 - 07.82 | CR | 4 | ■ | Y-918J | 6285 | | D-POWER 2 | 6285 |
| 80 S2 | 2.2 | 169 | 02.93 - 07.95 | ABY | 5 | 0,6 | PFR7B | 4853 | | PFR8B | 2781 |
| 80 TD | 1.6 | 51 | 02.82 - 03.87 | CY | 4 | ■ | Y-918J | 6285 | | D-POWER 2 | 6285 |
| 80 TD | 1.6 | 59 | 04.89 - 12.91 | SB | 4 | ■ | Y-918J | 6285 | | D-POWER 2 | 6285 |
| 80 TD | 1.9 | 55 | 09.91 - 07.95 | AAZ | 4 | ■ | Y-918J | 6285 | | D-POWER 2 | 6285 |
| 80 TDI | 1.9 | 66 | 09.91 - 07.95 | 1Z | 4 | ■ | Y-732J | 5605 | | D-POWER 4 | 5605 |
| 90 | 1.8 | 66 | 06.84 - 03.87 | JN | 4 | | BUR6ET | 3172 | 1 | LPG 2 | 1497 |
| 90 | 1.8 | 82 | 08.89 - 12.91 | DZ | 4 | | BUR6ET | 3172 | 1 | LPG 2 | 1497 |
| 90 | 2.0 | 81 | 10.84 - 03.87 | JL | 4 | | BUR6ET | 3172 | 1 | LPG 2 | 1497 |
| 90 | 2.0 | 85 | 10.84 - 03.87 | HP | 4 | | BUR6ET | 3172 | 1 | LPG 2 | 1497 |
| 90 | 2.0 | 85 | 10.84 - 03.87 | JS | 5 | | BUR6ET | 3172 | 1 | LPG 2 | 1497 |
| 90 | 2.0 | 85 | 04.87 - 12.91 | PS | 5 | | BUR6ET | 3172 | 1 | LPG 2 | 1497 |
| 90 | 2.0 | 118 | 08.88 - 10.91 | NM | 4 | | BCPR7ET | 2164 | | BCPR7EIX | 5690 |
| 90 | 2.2 | 85 | 01.85 - 03.87 | KX | 5 | | BUR6ET | 3172 | 1 | LPG 2 | 1497 |
| 90 | 2.2 | 88 | 08.85 - 03.87 | JT | 5 | | BUR6ET | 3172 | 1 | LPG 2 | 1497 |
| 90 | 2.2 | 100 | 06.84 - 03.87 | HY | 5 | | BUR6ET | 3172 | 1 | LPG 2 | 1497 |
| 90 | 2.2 | 100 | 06.84 - 12.91 | KV | 5 | | BUR6ET | 3172 | 1 | LPG 2 | 1497 |
| 90 | 2.3 | 98 | 04.87 - 12.91 | NG | 5 | | BPR5EKU | 5685 | | LPG 2 | 1497 |
| 90 | 2.3 | 125 | 06.88 - 12.91 | 7A | 5 | | BKUR7ET | 7873 | | PFR7Q | 7963 |
| 90 TD | 1.6 | 59 | 07.87 - 12.91 | SB | 4 | ■ | Y-918J | 6285 | | D-POWER 2 | 6285 |
| 100 | 1.6 | 75 | 03.92 - 07.93 | ABB | 4 | | BUR6ET | 3172 | 1 | LPG 2 | 1497 |
| 100 | 1.8 | 55 | 05.82 - 10.86 | DR | 4 | 0,7 | BP6ESZ | 7639 | | LPG 2 | 1497 |



ℓ kW

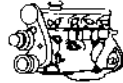

Cyl.

Order-
No.VLINE
No.LPG/CNG
D-PowerOrder-
No.**AUDI**

| | | | | | | | | | | | |
|-------------------|-----|-----|-------------|------|---|-----|------------|------|----|------------|------|
| 100 | 1.8 | 55 | 10.86-12.87 | RS | 4 | | BUR5ET-10 | 7264 | 21 | LPG 2 | 1497 |
| 100 | 1.8 | 65 | 02.86-07.90 | SH | 4 | | BUR6ET | 3172 | 1 | LPG 2 | 1497 |
| 100 | 1.8 | 66 | 10.84-12.90 | 4B | 4 | | BUR6ET | 3172 | 1 | LPG 2 | 1497 |
| 100 | 1.8 | 66 | 05.83-07.89 | DS | 4 | | BUR6ET | 3172 | 1 | LPG 2 | 1497 |
| 100 | 1.8 | 66 | 10.84-12.90 | NP | 4 | | BUR6ET | 3172 | 1 | LPG 2 | 1497 |
| 100 | 1.8 | 66 | 04.85-12.90 | PH | 4 | | BUR6ET | 3172 | 1 | LPG 2 | 1497 |
| 100 | 1.9 | 74 | 08.80-07.84 | WH | 4 | 0,7 | BP6ES | 7811 | 4 | LPG 2 | 1497 |
| 100 | 2.0 | 74 | 12.90-07.94 | AAE | 4 | | BUR6ET | 3172 | 1 | LPG 2 | 1497 |
| 100 | 2.0 | 79 | 12.93-07.94 | ADW | 4 | | BUR6ET | 3172 | 1 | LPG 2 | 1497 |
| 100 | 2.0 | 83 | 02.86-12.87 | SL | 4 | | BUR6ET | 3172 | 1 | LPG 2 | 1497 |
| 100 | 2.0 | 85 | 12.90-12.92 | AAD | 4 | | BUR6ET | 3172 | 1 | LPG 2 | 1497 |
| 100 | 2.0 | 85 | 01.93-07.94 | ABK | 4 | | BUR6ET | 3172 | 1 | LPG 2 | 1497 |
| 100 | 2.0 | 85 | 08.84-12.87 | KP | 5 | | BUR6ET | 3172 | 1 | LPG 2 | 1497 |
| 100 | 2.0 | 103 | 01.92-07.94 | ACE | 4 | | BKUR7ET | 7873 | | PFR7Q | 7963 |
| 100 | 2.2 | 85 | 08.84-09.86 | KZ | 5 | | BUR6ET | 3172 | 1 | LPG 2 | 1497 |
| 100 | 2.2 | 88 | 08.85-07.88 | PX | 5 | | BUR6ET | 3172 | 1 | LPG 2 | 1497 |
| 100 | 2.2 | 96 | 02.82-07.84 | KF | 5 | 0,7 | BP6ESZ | 7639 | | LPG 2 | 1497 |
| 100 | 2.2 | 101 | 08.84-07.86 | HX | 5 | | BUR6ET | 3172 | 1 | LPG 2 | 1497 |
| 100 | 2.2 | 101 | 08.84-12.90 | KU | 5 | | BUR6ET | 3172 | 1 | LPG 2 | 1497 |
| 100 | 2.2 | 121 | 03.86-12.90 | MC | 5 | | BUR6ET | 3172 | 1 | LPG 2 | 1497 |
| 100 | 2.3 | 98 | 12.90-07.94 | AAR | 5 | | BPR5EKU | 5685 | | LPG 2 | 1497 |
| 100 | 2.3 | 100 | 08.86-12.90 | NF | 5 | | BPR5EKU | 5685 | | LPG 2 | 1497 |
| 100 | 2.4 | 60 | 05.91-07.94 | AAS | 5 | ■ | Y-918J | 6285 | | D-POWER 2 | 6285 |
| 100 | 2.8 | 128 | 12.90-07.94 | AAH | 6 | | BKUR6ET-10 | 2397 | 24 | LPG 1 | 1496 |
| 100 (China / GUS) | 2.6 | 102 | 01.93-07.94 | ACZ | 6 | | BKUR6ET-10 | 2397 | 24 | LPG 1 | 1496 |
| 100 (China) | 1.8 | 66 | 03.83-12.90 | JW | 4 | | BUR6ET | 3172 | 1 | LPG 2 | 1497 |
| 100 (China) | 2.0 | 85 | 01.88-12.92 | RT | 5 | | BUR6ET | 3172 | 1 | LPG 2 | 1497 |
| 100 (China) | 2.6 | 110 | 03.92-07.94 | ABC | 5 | | BKUR6ET-10 | 2397 | 24 | LPG 1 | 1496 |
| 100 D | 2.4 | 60 | 08.89-12.90 | 3D | 5 | ■ | Y-918J | 6285 | | D-POWER 2 | 6285 |
| 100 D,TD | 2.0 | 51 | 08.82-11.90 | | 4 | ■ | Y-918J | 6285 | | D-POWER 2 | 6285 |
| 100 TDI | 2.5 | 85 | 08.91-07.94 | AAT | 5 | ■ | Y-732J | 5605 | | D-POWER 4 | 5605 |
| 100 TDI | 2.5 | 85 | 04.91-07.92 | ABP | 5 | ■ | Y-732J | 5605 | | D-POWER 4 | 5605 |
| 100 TDI | 2.5 | 88 | 01.90-12.90 | 1T | 5 | ■ | Y-732J | 5605 | | D-POWER 4 | 5605 |
| 200 | 2.2 | 101 | 08.84-07.85 | KU | 5 | | BUR6ET | 3172 | 1 | LPG 2 | 1497 |
| 200 | 2.2 | 121 | 01.85-11.90 | MC | 5 | | BUR6ET | 3172 | 1 | LPG 2 | 1497 |
| 200 | 2.2 | 125 | 08.80-12.81 | WS | 5 | 0,8 | BP7EVX | 7270 | | BPR8EIX | 6684 |
| 200 | 2.2 | 134 | 08.83-01.87 | JY | 5 | | BUR6ET | 3172 | 1 | LPG 2 | 1497 |
| 200 | 2.2 | 134 | 08.83-12.87 | KG | 5 | | BUR6ET | 3172 | 1 | LPG 2 | 1497 |
| 200 | 2.2 | 147 | 02.88-11.90 | 1B | 5 | | BUR6ET | 3172 | 1 | LPG 2 | 1497 |
| 200 | 2.2 | 162 | 03.89-11.90 | 3B | 5 | 0,6 | PFR7B | 4853 | | PFR8B | 2781 |
| 200 | 2.3 | 140 | 02.88-11.90 | 2B | 5 | | BUR6ET | 3172 | 1 | LPG 2 | 1497 |
| A 1 TFSI | 1.4 | 90 | 05.10- | CAXA | 4 | | PZFR6R | 5758 | | PZFR6R | 5758 |
| A 1 TDI | 1.6 | 66 | 11.10- | CAYB | 4 | ■ | Y1002AS | 8888 | | D-POWER 57 | 8888 |
| A 1 TDI | 1.6 | 77 | 05.10- | CAYC | 4 | ■ | Y1002AS | 8888 | | D-POWER 57 | 8888 |
| A 2 | 1.4 | 55 | 06.00-04.02 | AUA | 4 | | BKUR6ET-10 | 2397 | 24 | LPG 1 | 1496 |
| A 2 | 1.4 | 55 | 05.02-08.05 | BBY | 4 | | BKUR6ET-10 | 2397 | 24 | LPG 1 | 1496 |
| A 2 FSI | 1.6 | 81 | 05.02-08.05 | BAD | 4 | | ZFR6S-Q | 6449 | | ZFR6S-Q | 6449 |
| A 2 TDI | 1.2 | 45 | 03.01-08.05 | ANY | 3 | ■ | Y-741U | 6943 | | D-POWER 20 | 6943 |
| A 2 TDI | 1.4 | 55 | 06.00-08.03 | AMF | 3 | ■ | Y-741U | 6943 | | D-POWER 20 | 6943 |
| A 2 TDI | 1.4 | 55 | 09.03-08.05 | BHC | 3 | ■ | Y-741U | 6943 | | D-POWER 20 | 6943 |
| A 2 TDI | 1.4 | 66 | 11.03-08.05 | ATL | 3 | ■ | Y-607AS | 7560 | | D-POWER 50 | 7560 |
| A 3 | 1.6 | 74 | 09.96-06.01 | AEH | 4 | | BKUR6ET-10 | 2397 | 24 | LPG 1 | 1496 |



l kW



Cyl.

Order-
No. No.LPG/CNG
D-PowerOrder-
No.**AUDI**

| | | | | | | | | | | | |
|---------|-----|-----|---------------|------|---|-----|------------|------|----|------------|------|
| A 3 | 1.6 | 74 | 08.97 - 06.03 | AKL | 4 | | BKUR6ET-10 | 2397 | 24 | LPG 1 | 1496 |
| A 3 | 1.6 | 74 | 06.99 - 08.00 | APF | 4 | | BKUR6ET-10 | 2397 | 24 | LPG 1 | 1496 |
| A 3 | 1.6 | 74 | 05.00 - 04.02 | AVU | 4 | | BKUR6ET-10 | 2397 | 24 | LPG 1 | 1496 |
| A 3 | 1.6 | 75 | 05.02 - 06.03 | BFQ | 4 | | BKUR6ET-10 | 2397 | 24 | LPG 1 | 1496 |
| A 3 | 1.6 | 75 | 05.03 - 05.05 | BGU | 4 | | BKUR6ET-10 | 2397 | 24 | LPG 1 | 1496 |
| A 3 | 1.6 | 75 | 06.05 - | BSE | 4 | | BKUR6ET-10 | 2397 | 24 | LPG 1 | 1496 |
| A 3 | 1.6 | 75 | 06.05 - | BSF | 4 | | BKUR6ET-10 | 2397 | 24 | LPG 1 | 1496 |
| A 3 | 1.6 | 75 | 07.08 - | CCSA | 4 | | BKUR6ET-10 | 2397 | 24 | LPG 1 | 1496 |
| A 3 | 1.6 | 75 | 05.10 - | CMXA | 4 | | BKUR6ET-10 | 2397 | 24 | LPG 1 | 1496 |
| A 3 | 1.8 | 92 | 09.96 - 08.00 | AGN | 4 | | BKUR6ET-10 | 2397 | 24 | LPG 1 | 1496 |
| A 3 | 1.8 | 92 | 11.99 - 06.03 | APG | 4 | | BKUR6ET-10 | 2397 | 24 | LPG 1 | 1496 |
| A 3 | 1.8 | 110 | 12.96 - 06.03 | AGU | 4 | 0,8 | PFR6Q | 6458 | 37 | LPG 1 | 1496 |
| A 3 | 1.8 | 110 | 08.98 - 04.01 | AQA | 4 | 0,8 | PFR6Q | 6458 | 37 | LPG 1 | 1496 |
| A 3 | 1.8 | 110 | 09.00 - 06.03 | ARX | 4 | 0,8 | PFR6Q | 6458 | 37 | LPG 1 | 1496 |
| A 3 | 1.8 | 110 | 07.99 - 04.00 | ARZ | 4 | 0,8 | PFR6Q | 6458 | 37 | LPG 1 | 1496 |
| A 3 | 1.8 | 110 | 05.00 - 06.03 | AUM | 4 | 0,8 | PFR6Q | 6458 | 37 | LPG 1 | 1496 |
| A 3 | 1.8 | 118 | 01.07 - 05.07 | BYT | 4 | 0,8 | PFR7S8EG | 1675 | | | |
| A 3 | 1.8 | 118 | 07.08 - | CDA | 4 | 0,8 | PFR7S8EG | 1675 | | | |
| A 3 | 1.8 | 132 | 11.98 - 08.00 | AJQ | 4 | 0,8 | PFR6Q | 6458 | 37 | LPG 1 | 1496 |
| A 3 | 1.8 | 132 | 07.99 - 05.00 | APP | 4 | 0,8 | PFR6Q | 6458 | 37 | LPG 1 | 1496 |
| A 3 | 1.8 | 132 | 09.00 - 06.03 | ARY | 4 | 0,8 | PFR6Q | 6458 | 37 | LPG 1 | 1496 |
| A 3 | 1.8 | 132 | 05.00 - 06.03 | AUQ | 4 | 0,8 | PFR6Q | 6458 | 37 | LPG 1 | 1496 |
| A 3 | 2.0 | 147 | 07.08 - | CBFA | 4 | 0,8 | PFR7S8EG | 1675 | | | |
| A 3 | 2.0 | 147 | 07.08 - | CCZA | 4 | 0,8 | PFR7S8EG | 1675 | | | |
| A 3 | 3.2 | 184 | 07.03 - 08.04 | BDB | 6 | 0,9 | IZKR7B | 7563 | | IZKR7B | 7563 |
| A 3 | 3.2 | 184 | 09.04 - 10.05 | BMJ | 6 | 0,9 | IZKR7B | 7563 | | IZKR7B | 7563 |
| A 3 | 3.2 | 184 | 11.05 - | BUB | 6 | 0,9 | IZKR7B | 7563 | | IZKR7B | 7563 |
| A 3 FSI | 1.6 | 85 | 08.03 - 05.04 | BAG | 4 | | ZFR6S-Q | 6449 | | ZFR6S-Q | 6449 |
| A 3 FSI | 1.6 | 85 | 01.05 - 05.07 | BLF | 4 | | ZFR6S-Q | 6449 | | ZFR6S-Q | 6449 |
| A 3 FSI | 1.6 | 85 | 06.04 - 12.04 | BLP | 4 | | ZFR6S-Q | 6449 | | ZFR6S-Q | 6449 |
| A 3 FSI | 2.0 | 110 | 05.03 - 05.04 | AXW | 4 | | PZFR5N-11T | 7742 | | PZFR5N-11T | 7742 |
| A 3 FSI | 2.0 | 110 | 01.05 - 11.05 | BLR | 4 | | PZFR5N-11T | 7742 | | PZFR5N-11T | 7742 |
| A 3 FSI | 2.0 | 110 | 06.04 - 01.05 | BLX | 4 | | PZFR5N-11T | 7742 | | PZFR5N-11T | 7742 |
| A 3 FSI | 2.0 | 110 | 06.04 - 11.05 | BLY | 4 | 0,9 | BKR6E | 6962 | 28 | LPG 1 | 1496 |
| A 3 FSI | 2.0 | 110 | 01.04 - 01.05 | BMB | 4 | 0,9 | BKR6E | 6962 | 28 | LPG 1 | 1496 |
| A 3 FSI | 2.0 | 110 | 11.05 - 01.07 | BVY | 4 | | PZFR5N-11T | 7742 | | PZFR5N-11T | 7742 |
| A 3 FSI | 2.0 | 110 | 11.05 - | BVZ | 4 | 0,9 | BKR6E | 6962 | 28 | LPG 1 | 1496 |
| A 3 FSI | 2.0 | 147 | 02.08 - 01.09 | CAWB | 4 | 0,8 | PFR7S8EG | 1675 | | | |
| A 3 S 3 | 1.8 | 154 | 09.00 - 04.02 | AMK | 4 | 0,8 | PFR6Q | 6458 | 37 | LPG 1 | 1496 |
| A 3 S 3 | 1.8 | 154 | 11.98 - 08.00 | APY | 4 | 0,8 | PFR6Q | 6458 | 37 | LPG 1 | 1496 |
| A 3 S 3 | 1.8 | 154 | 09.99 - 04.01 | AUL | 4 | 0,8 | PFR6Q | 6458 | 37 | LPG 1 | 1496 |
| A 3 S 3 | 1.8 | 165 | 08.01 - 06.03 | BAM | 4 | 0,8 | PFR6Q | 6458 | 37 | LPG 1 | 1496 |
| A 3 S 3 | 2.0 | 188 | 02.07 - | BZC | 4 | 0,8 | PFR7S8EG | 1675 | | | |
| A 3 S 3 | 2.0 | 188 | 07.08 - | CDLC | 4 | 0,8 | PFR7S8EG | 1675 | | | |
| A 3 S 3 | 2.0 | 195 | 11.06 - 05.07 | BHZ | 4 | 0,8 | PFR7S8EG | 1675 | | | |
| A 3 S 3 | 2.0 | 195 | 07.08 - | CDLA | 4 | 0,8 | PFR7S8EG | 1675 | | | |
| A 3 TDI | 1.6 | 66 | 05.09 - | CAYB | 4 | █ | Y1002AS | 8888 | | D-POWER 57 | 8888 |
| A 3 TDI | 1.6 | 77 | 05.09 - | CAYC | 4 | █ | Y1002AS | 8888 | | D-POWER 57 | 8888 |
| A 3 TDI | 1.9 | 66 | 09.96 - 08.00 | AGR | 4 | █ | Y-732J | 5605 | | D-POWER 4 | 5605 |
| A 3 TDI | 1.9 | 66 | 08.97 - 06.01 | ALH | 4 | █ | Y-732J | 5605 | | D-POWER 4 | 5605 |
| A 3 TDI | 1.9 | 77 | 06.03 - 05.06 | BKC | 4 | █ | Y-607AS | 7560 | | D-POWER 50 | 7560 |
| A 3 TDI | 1.9 | 77 | 10.05 - 05.07 | BLS | 4 | █ | Y-607AS | 7560 | | D-POWER 50 | 7560 |



ℓ kW

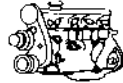

Cyl.

Order-
No.VLINE
No.LPG/CNG
D-PowerOrder-
No.**AUDI**

| | | | | | | | | | | | |
|-----------------------------|-----|-----|--------------|------|---|-----|------------|------|----|------------|------|
| A 3 TDI | 1.9 | 77 | 06.06 - | BXE | 4 | █ | Y-607AS | 7560 | | D-POWER 50 | 7560 |
| A 3 TDI | 1.9 | 81 | 01.97 -04.02 | AHF | 4 | █ | Y-732J | 5605 | | D-POWER 4 | 5605 |
| A 3 TDI | 1.9 | 81 | 09.99 -06.01 | ASV | 4 | █ | Y-732J | 5605 | | D-POWER 4 | 5605 |
| A 3 TDI | 2.0 | 100 | 05.03 -05.07 | AZV | 4 | █ | YE14 | 7768 | | D-POWER 48 | 7768 |
| A 3 TDI | 2.0 | 100 | 04.08 -05.10 | CBAA | 4 | █ | Y-609AS | 5849 | | D-POWER 49 | 5849 |
| A 3 TDI | 2.0 | 100 | 11.09 - | CFFA | 4 | █ | Y1002AS | 8888 | | D-POWER 57 | 8888 |
| A 3 TDI | 2.0 | 103 | 05.03 -05.07 | BKD | 4 | █ | YE14 | 7768 | | D-POWER 48 | 7768 |
| A 3 TDI | 2.0 | 103 | 06.05 -05.07 | BMM | 4 | █ | CZ104 | 9826 | | D-POWER 52 | 9826 |
| A 3 TDI | 2.0 | 103 | 04.08 -05.10 | CBAB | 4 | █ | Y-609AS | 5849 | | D-POWER 49 | 5849 |
| A 3 TDI | 2.0 | 103 | 11.09 - | CFFB | 4 | █ | Y1002AS | 8888 | | D-POWER 57 | 8888 |
| A 3 TDI | 2.0 | 103 | 02.10 - | CLJA | 4 | █ | Y1002AS | 8888 | | D-POWER 57 | 8888 |
| A 3 TDI | 2.0 | 120 | 06.06 -05.07 | BUY | 4 | █ | CZ304 | 9864 | | D-POWER 55 | 9864 |
| A 3 TDI | 2.0 | 125 | 03.06 - | BMN | 4 | █ | CZ304 | 9864 | | D-POWER 55 | 9864 |
| A 3 TDI | 2.0 | 125 | 07.08 -05.10 | CBBB | 4 | █ | Y-609AS | 5849 | | D-POWER 49 | 5849 |
| A 3 TDI | 2.0 | 125 | 05.10 - | CFGB | 4 | █ | Y1002AS | 8888 | | D-POWER 57 | 8888 |
| A 3 TDI Fgst → 8L-2-037-877 | 1.9 | 74 | 01.01 -06.03 | ATD | 4 | █ | Y-732J | 5605 | | D-POWER 4 | 5605 |
| A 3 TDI Fgst → 8L-2-037-877 | 1.9 | 74 | 11.01 -06.03 | AXR | 4 | █ | Y-732J | 5605 | | D-POWER 4 | 5605 |
| A 3 TDI Fgst → 8L-2-037-877 | 1.9 | 96 | 05.00 -06.03 | ASZ | 4 | █ | Y-732J | 5605 | | D-POWER 4 | 5605 |
| A 3 TDI Fgst 8L-2-037-878 → | 1.9 | 74 | 01.01 -06.03 | ATD | 4 | █ | Y-741U | 6943 | | D-POWER 20 | 6943 |
| A 3 TDI Fgst 8L-2-037-878 → | 1.9 | 74 | 11.01 -06.03 | AXR | 4 | █ | Y-741U | 6943 | | D-POWER 20 | 6943 |
| A 3 TDI Fgst 8L-2-037-878 → | 1.9 | 96 | 05.00 -06.03 | ASZ | 4 | █ | Y-741U | 6943 | | D-POWER 20 | 6943 |
| A 3 TFSI | 1.4 | 92 | 09.07 - | CAXC | 4 | 0,9 | PZFR6R | 5758 | | PZFR6R | 5758 |
| A 3 TFSI | 1.8 | 118 | 06.07 -05.08 | BZB | 4 | 0,8 | PFR7S8EG | 1675 | | | |
| A 3 TFSI | 2.0 | 147 | 09.04 -10.05 | AXX | 4 | 0,8 | PFR7S8EG | 1675 | | | |
| A 3 TFSI | 2.0 | 147 | 09.05 - | BWA | 4 | 0,8 | PFR7S8EG | 1675 | | | |
| A 4 | 1.6 | 74 | 11.94 -10.96 | ADP | 4 | | BKUR6ET-10 | 2397 | 24 | LPG 1 | 1496 |
| A 4 | 1.6 | 74 | 10.96 -07.99 | AHL | 4 | | BKUR6ET-10 | 2397 | 24 | LPG 1 | 1496 |
| A 4 | 1.6 | 74 | 08.98 -06.00 | ANA | 4 | | BKUR6ET-10 | 2397 | 24 | LPG 1 | 1496 |
| A 4 | 1.6 | 74 | 08.98 -09.01 | ARM | 4 | | BKUR6ET-10 | 2397 | 24 | LPG 1 | 1496 |
| A 4 | 1.6 | 75 | 06.00 -06.08 | ALZ | 4 | | BKUR6ET-10 | 2397 | 24 | LPG 1 | 1496 |
| A 4 | 1.8 | 85 | 07.95 -12.98 | AFY | 4 | | BKUR6ET-10 | 2397 | 24 | LPG 1 | 1496 |
| A 4 | 1.8 | 88 | 01.08 -05.08 | CABA | 4 | 0,8 | PFR7S8EG | 1675 | | | |
| A 4 | 1.8 | 88 | 06.08 - | CDHA | 4 | 0,8 | PFR7S8EG | 1675 | | | |
| A 4 | 1.8 | 92 | 11.94 -04.99 | ADR | 4 | | BKUR6ET-10 | 2397 | 24 | LPG 1 | 1496 |
| A 4 | 1.8 | 92 | 02.99 -09.01 | APT | 4 | | BKUR6ET-10 | 2397 | 24 | LPG 1 | 1496 |
| A 4 | 1.8 | 92 | 07.98 -09.01 | ARG | 4 | | BKUR6ET-10 | 2397 | 24 | LPG 1 | 1496 |
| A 4 | 1.8 | 92 | 06.00 -09.01 | AVV | 4 | | BKUR6ET-10 | 2397 | 24 | LPG 1 | 1496 |
| A 4 | 1.8 | 110 | 01.96 -12.98 | AEB | 4 | 0,8 | PFR6Q | 6458 | 37 | LPG 1 | 1496 |
| A 4 | 1.8 | 110 | 05.99 -06.00 | ANB | 4 | 0,8 | PFR6Q | 6458 | 37 | LPG 1 | 1496 |
| A 4 | 1.8 | 110 | 08.98 -09.01 | APU | 4 | 0,8 | PFR6Q | 6458 | 37 | LPG 1 | 1496 |
| A 4 | 1.8 | 110 | 07.98 -07.99 | ARK | 4 | 0,8 | PFR6Q | 6458 | 37 | LPG 1 | 1496 |
| A 4 | 1.8 | 110 | 12.00 -06.02 | AVJ | 4 | 0,8 | PFR6Q | 6458 | 37 | LPG 1 | 1496 |
| A 4 | 1.8 | 110 | 06.00 -09.01 | AWT | 4 | 0,8 | PFR6Q | 6458 | 37 | LPG 1 | 1496 |
| A 4 | 1.8 | 118 | 11.07 -05.08 | CABB | 4 | 0,8 | PFR7S8EG | 1675 | | | |
| A 4 | 1.8 | 118 | 06.08 - | CDHB | 4 | 0,8 | PFR7S8EG | 1675 | | | |
| A 4 | 1.8 | 132 | 08.97 -09.01 | AJL | 4 | 0,8 | PFR6Q | 6458 | 37 | LPG 1 | 1496 |
| A 4 | 1.8 | 140 | 11.02 -12.04 | BEX | 4 | 0,8 | PFR6Q | 6458 | 37 | LPG 1 | 1496 |
| A 4 | 2.0 | 96 | 12.00 - | ALT | 4 | | BKUR5ET-10 | 7553 | | LPG 1 | 1496 |
| A 4 | 2.0 | 132 | 06.08 - | CDNB | 4 | 0,8 | PFR7S8EG | 1675 | | | |
| A 4 | 2.0 | 155 | 06.08 - | CDNC | 4 | 0,8 | PFR7S8EG | 1675 | | | |
| A 4 | 2.0 | 162 | 06.05 - | BUL | 4 | 0,8 | PFR7S8EG | 1675 | | | |
| A 4 | 2.4 | 120 | 08.97 -07.98 | AJG | 6 | | BKR6EKUB | 3584 | | LPG 1 | 1496 |

Fgst = Chassis No.



ℓ kW

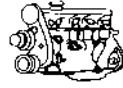

Cyl.

Order-
No. No.LPG/CNG
D-PowerOrder-
No.**AUDI**

| | | | | | | | | | | | |
|-------------------|-----|-----|---------------|------|---|-----|------------|------|----|------------|------|
| A 4 | 2.4 | 120 | 06.00 - 09.01 | AMM | 6 | | BKR6EKUB | 3584 | | LPG 1 | 1496 |
| A 4 | 2.4 | 120 | 08.98 - 06.00 | APZ | 6 | | BKR6EKUB | 3584 | | LPG 1 | 1496 |
| A 4 | 2.4 | 121 | 08.97 - 07.98 | AGA | 6 | | BKR6EKUB | 3584 | | LPG 1 | 1496 |
| A 4 | 2.4 | 121 | 08.97 - 07.98 | ALF | 6 | | BKR6EKUB | 3584 | | LPG 1 | 1496 |
| A 4 | 2.4 | 121 | 08.98 - 09.01 | AML | 6 | | BKR6EKUB | 3584 | | LPG 1 | 1496 |
| A 4 | 2.4 | 121 | 08.98 - 06.00 | ARJ | 6 | | BKR6EKUB | 3584 | | LPG 1 | 1496 |
| A 4 | 2.8 | 128 | 11.94 - 07.97 | AAH | 6 | | BKUR6ET-10 | 2397 | 24 | LPG 1 | 1496 |
| A 4 | 2.8 | 142 | 05.97 - 07.98 | ALG | 6 | | BKR6EKUB | 3584 | | LPG 1 | 1496 |
| A 4 | 2.8 | 142 | 07.98 - 09.01 | AMX | 6 | | BKR6EKUB | 3584 | | LPG 1 | 1496 |
| A 4 | 2.8 | 142 | 08.98 - 06.00 | APR | 6 | | BKR6EKUB | 3584 | | LPG 1 | 1496 |
| A 4 | 2.8 | 142 | 08.98 - 06.00 | AQD | 6 | | BKR6EKUB | 3584 | | LPG 1 | 1496 |
| A 4 | 3.0 | 162 | 12.00 - 12.05 | ASN | 6 | | BKR6EKUB | 3584 | | LPG 1 | 1496 |
| A 4 | 3.0 | 162 | 09.01 - 06.02 | AVK | 6 | 1,1 | PFR6U-11G | 5874 | | PFR6U-11G | 5874 |
| A 4 | 3.2 | 195 | 11.07 - | CALA | 6 | 1,1 | PFR6X-11 | 5757 | | PFR6X-11 | 5757 |
| A 4 (USA) | 2.8 | 128 | 08.94 - 07.98 | AFC | 6 | | BKUR6ET-10 | 2397 | 24 | LPG 1 | 1496 |
| A 4 China | 2.0 | 147 | 09.05 - | BWE | 4 | 0,8 | PFR7S8EG | 1675 | | | |
| A 4 (China / GUS) | 2.6 | 102 | 06.94 - 10.97 | ACZ | 6 | | BKUR6ET-10 | 2397 | 24 | LPG 1 | 1496 |
| A 4 China | 1.8 | 120 | 07.02 - | BFB | 4 | 0,8 | PFR6Q | 6458 | 37 | LPG 1 | 1496 |
| A 4 China | 2.4 | 110 | 07.95 - 07.97 | AFM | 6 | | BKUR6ET-10 | 2397 | 24 | LPG 1 | 1496 |
| A 4 China | 2.4 | 121 | 08.98 - 09.01 | APS | 6 | | BKR6EKUB | 3584 | | LPG 1 | 1496 |
| A 4 China | 2.4 | 125 | 09.01 - 12.05 | BDV | 6 | | BKR6EKUB | 3584 | | LPG 1 | 1496 |
| A 4 China | 2.6 | 110 | 11.94 - 07.97 | ABC | 6 | | BKUR6ET-10 | 2397 | 24 | LPG 1 | 1496 |
| A 4 China | 3.0 | 160 | 04.01 - 05.06 | BBJ | 6 | | BKR6EKUB | 3584 | | LPG 1 | 1496 |
| A 4 (B6) (USA) | 1.8 | 110 | 08.99 - 05.00 | ATW | 4 | 0,8 | PFR6Q | 6458 | 37 | LPG 1 | 1496 |
| A 4 30V | 2.8 | 142 | 03.96 - 07.98 | ACK | 6 | | BKR6EKUB | 3584 | | LPG 1 | 1496 |
| A 4 FSI | 2.0 | 110 | 07.02 - 12.04 | AWA | 4 | | PZFR5N-11T | 7742 | | PZFR5N-11T | 7742 |
| A 4 FSI | 3.2 | 188 | 01.05 - | AUK | 6 | | PFR7W-T | 6840 | | PFR7W-T | 6840 |
| A 4 RS 4 biturbo | 2.7 | 280 | 06.00 - 10.00 | ASJ | 6 | | PFR7Q | 7963 | | PFR7Q | 7963 |
| A 4 RS 4 V8 FSI | 4.2 | 309 | 11.05 - | BNS | 8 | | PFR7W-TG | 5592 | | PFR7W-TG | 5592 |
| A 4 RS4 | 2.8 | 280 | 11.00 - 09.01 | AZR | 6 | | PFR7Q | 7963 | | PFR7Q | 7963 |
| A 4 S 4 | 2.2 | 169 | 08.91 - 07.94 | AAN | 5 | 0,6 | PFR7B | 4853 | | PFR8B | 2781 |
| A 4 S 4 | 2.7 | 195 | 11.00 - 09.01 | AZB | 6 | 0,8 | PFR6Q | 6458 | 37 | LPG 1 | 1496 |
| A 4 S 4 | 4.2 | 206 | 10.92 - 07.94 | ABH | 8 | 0,8 | BUR6EFSZ | 6837 | | | |
| A 4 S 4 | 4.2 | 253 | 03.03 - | BBK | 8 | | BKR6EQUA | 6872 | | LPG 1 | 1496 |
| A 4 S 4 | 4.2 | 253 | 03.06 - | BHF | 8 | | BKR6EQUA | 6872 | | LPG 1 | 1496 |
| A 4 S 4 biturbo | 2.7 | 169 | 07.98 - 08.00 | AJK | 6 | 0,8 | PFR6Q | 6458 | 37 | LPG 1 | 1496 |
| A 4 S 4 biturbo | 2.7 | 184 | 07.98 - 12.98 | APB | 6 | 0,8 | PFR6Q | 6458 | 37 | LPG 1 | 1496 |
| A 4 S 4 biturbo | 2.7 | 195 | 10.97 - 09.01 | AGB | 6 | 0,8 | PFR6Q | 6458 | 37 | LPG 1 | 1496 |
| A 4 TDI | 1.9 | 55 | 03.96 - 06.00 | AFF | 4 | | Y-732J | 5605 | | D-POWER 4 | 5605 |
| A 4 TDI | 1.9 | 66 | 11.94 - 07.96 | 1Z | 4 | | Y-732J | 5605 | | D-POWER 4 | 5605 |
| A 4 TDI | 1.9 | 66 | 04.97 - 09.01 | AHH | 4 | | Y-732J | 5605 | | D-POWER 4 | 5605 |
| A 4 TDI | 1.9 | 66 | 08.96 - 06.00 | AHU | 4 | | Y-732J | 5605 | | D-POWER 4 | 5605 |
| A 4 TDI | 1.9 | 81 | 02.96 - 07.99 | AFN | 4 | | Y-732J | 5605 | | D-POWER 4 | 5605 |
| A 4 TDI | 1.9 | 81 | 08.99 - 06.00 | AVG | 4 | | Y-732J | 5605 | | D-POWER 4 | 5605 |
| A 4 TDI | 1.9 | 85 | 08.98 - 09.01 | AJM | 4 | | Y-732J | 5605 | | D-POWER 4 | 5605 |
| A 4 TDI | 1.9 | 85 | 01.00 - 09.01 | ATJ | 4 | | Y-732J | 5605 | | D-POWER 4 | 5605 |
| A 4 TDI | 1.9 | 85 | 11.05 - | BRB | 4 | | CZ104 | 9826 | | D-POWER 52 | 9826 |
| A 4 TDI | 2.0 | 88 | 06.08 - | CAGC | 4 | | Y-609AS | 5849 | | D-POWER 49 | 5849 |
| A 4 TDI | 2.0 | 89 | 01.06 - 09.06 | BVG | 4 | | CZ304 | 9864 | | D-POWER 55 | 9864 |
| A 4 TDI | 2.0 | 93 | 11.05 - 11.06 | BVF | 4 | | CZ304 | 9864 | | D-POWER 55 | 9864 |
| A 4 TDI | 2.0 | 100 | 11.04 - 10.05 | BNA | 4 | | YE14 | 7768 | | D-POWER 48 | 7768 |
| A 4 TDI | 2.0 | 100 | 11.05 - | BRF | 4 | | CZ304 | 9864 | | D-POWER 55 | 9864 |



ℓ kW

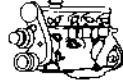

Cyl.

Order-
No. No.

VLINE

LPG/CNG
D-PowerOrder-
No.**AUDI**

| | | | | | | | | | | |
|-----------------------------|-----|-----|---------------|------|---|--------------|------|--|------------|------|
| A 4 TDI | 2.0 | 100 | 11.07 - | CAGB | 4 | Y-609AS | 5849 | | D-POWER 49 | 5849 |
| A 4 TDI | 2.0 | 100 | 11.10 - | CJCB | 4 | Y1002AS | 8888 | | D-POWER 57 | 8888 |
| A 4 TDI | 2.0 | 103 | 11.04 - 11.05 | BLB | 4 | YE14 | 7768 | | D-POWER 48 | 7768 |
| A 4 TDI | 2.0 | 103 | 11.04 - | BPW | 4 | CZ104 | 9826 | | D-POWER 52 | 9826 |
| A 4 TDI | 2.0 | 103 | 10.05 - | BRE | 4 | CZ304 | 9864 | | D-POWER 55 | 9864 |
| A 4 TDI | 2.0 | 105 | 11.07 - | CAGA | 4 | Y-609AS | 5849 | | D-POWER 49 | 5849 |
| A 4 TDI | 2.0 | 105 | 05.10 - | CMEA | 4 | Y1002AS | 8888 | | D-POWER 57 | 8888 |
| A 4 TDI | 2.0 | 120 | 06.06 - | BVA | 4 | CZ304 | 9864 | | D-POWER 55 | 9864 |
| A 4 TDI | 2.0 | 120 | 08.08 - | CAHB | 4 | Y-609AS | 5849 | | D-POWER 49 | 5849 |
| A 4 TDI | 2.0 | 125 | 06.06 - | BRD | 4 | CZ304 | 9864 | | D-POWER 55 | 9864 |
| A 4 TDI | 2.0 | 125 | 08.08 - | CAHA | 4 | Y-609AS | 5849 | | D-POWER 49 | 5849 |
| A 4 TDI | 2.5 | 110 | 11.97 - 06.00 | AFB | 6 | Y-501U | 3786 | | D-POWER 31 | 4187 |
| A 4 TDI | 2.5 | 110 | 07.98 - 09.01 | AKN | 6 | Y-501U | 3786 | | D-POWER 31 | 4187 |
| A 4 TDI | 2.5 | 114 | 04.01 - 06.02 | AYM | 6 | Y-501U | 3786 | | D-POWER 31 | 4187 |
| A 4 TDI | 2.5 | 120 | 06.03 - 12.05 | BCZ | 6 | Y-501U | 3786 | | D-POWER 31 | 4187 |
| A 4 TDI | 2.5 | 120 | 06.03 - 05.06 | BDG | 6 | Y-501U | 3786 | | D-POWER 31 | 4187 |
| A 4 TDI | 2.5 | 120 | 07.02 - 05.03 | BFC | 6 | Y-501U | 3786 | | D-POWER 31 | 4187 |
| A 4 TDI | 2.5 | 132 | 12.00 - 05.03 | AKE | 6 | Y-501U | 3786 | | D-POWER 31 | 4187 |
| A 4 TDI | 2.5 | 132 | 06.03 - 12.04 | BAU | 6 | Y-501U | 3786 | | D-POWER 31 | 4187 |
| A 4 TDI | 2.5 | 132 | 06.03 - 12.04 | BDH | 6 | Y-501U | 3786 | | D-POWER 31 | 4187 |
| A 4 TDI | 2.7 | 120 | 11.05 - 06.08 | BSG | 6 | Y-609AS | 5849 | | D-POWER 49 | 5849 |
| A 4 TDI | 2.7 | 120 | 11.07 - 05.08 | CAMB | 6 | Y-609AS | 5849 | | D-POWER 49 | 5849 |
| A 4 TDI | 2.7 | 130 | 01.06 - 03.09 | BPP | 6 | Y-609AS | 5849 | | D-POWER 49 | 5849 |
| A 4 TDI | 2.7 | 140 | 11.07 - 05.08 | CAMA | 6 | Y-609AS | 5849 | | D-POWER 49 | 5849 |
| A 4 TDI | 3.0 | 155 | 06.08 - 05.10 | CCWB | 6 | Y-609AS | 5849 | | D-POWER 49 | 5849 |
| A 4 TDI | 3.0 | 171 | 01.06 - 03.09 | ASB | 6 | Y-609AS | 5849 | | D-POWER 49 | 5849 |
| A 4 TDI | 3.0 | 176 | 04.08 - | CCWA | 6 | Y-609AS | 5849 | | D-POWER 49 | 5849 |
| A 4 TDI | 3.0 | 177 | 11.07 - 05.08 | CAPA | 6 | Y-609AS | 5849 | | D-POWER 49 | 5849 |
| A 4 TDI China | 3.0 | 150 | 11.04 - 03.09 | BKN | 6 | Y-609AS | 5849 | | D-POWER 49 | 5849 |
| A 4 TDI Fgst 8E-5-070251 → | 1.9 | 85 | 06.04 - 12.05 | BKE | 4 | Y-607AS | 7560 | | D-POWER 50 | 7560 |
| A 4 TDI Fgst → 8E-2-148-697 | 1.9 | 74 | 04.01 - 05.04 | AVB | 4 | Y-732J | 5605 | | D-POWER 4 | 5605 |
| A 4 TDI Fgst → 8E-2-148-697 | 1.9 | 96 | 11.00 - 12.04 | AVF | 4 | Y-732J | 5605 | | D-POWER 4 | 5605 |
| A 4 TDI Fgst → 8E-2-148-697 | 1.9 | 96 | 12.00 - 06.03 | AWX | 4 | Y-732J | 5605 | | D-POWER 4 | 5605 |
| A 4 TDI Fgst 8E-2-148-698 → | 1.9 | 74 | 04.01 - 05.04 | AVB | 4 | Y-741U | 6943 | | D-POWER 20 | 6943 |
| A 4 TDI Fgst 8E-2-148-698 → | 1.9 | 96 | 11.00 - 12.04 | AVF | 4 | Y-741U | 6943 | | D-POWER 20 | 6943 |
| A 4 TDI Fgst 8E-2-148-698 → | 1.9 | 96 | 12.00 - 06.03 | AWX | 4 | Y-741U | 6943 | | D-POWER 20 | 6943 |
| A 4 TFSI | 2.0 | 125 | 03.07 - | BPJ | 4 | 0,8 PFR7S8EG | 1675 | | | |
| A 4 TFSI China | 2.0 | 147 | 11.04 - 08.05 | BGB | 4 | 0,8 PFR7S8EG | 1675 | | | |
| A 4 (China,SA) | 2.8 | 140 | 03.99 - 09.01 | ATX | 6 | BKR6EKUB | 3584 | | LPG 1 | 1496 |
| A 5 | 1.8 | 118 | 05.09 - | CDHB | 4 | 0,8 PFR7S8EG | 1675 | | | |
| A 5 | 1.8 | 125 | 10.07 - 11.08 | CABD | 4 | 0,8 PFR7S8EG | 1675 | | | |
| A 5 | 2.0 | 132 | 09.08 - | CDNB | 4 | 0,8 PFR7S8EG | 1675 | | | |
| A 5 | 2.0 | 155 | 06.08 - | CAEB | 4 | 0,8 PFR7S8EG | 1675 | | | |
| A 5 | 2.0 | 155 | 06.08 - | CDNC | 4 | 0,8 PFR7S8EG | 1675 | | | |
| A 5 | 3.2 | 195 | 06.07 - | CALA | 6 | 1,1 PFR6X-11 | 5757 | | PFR6X-11 | 5757 |
| A 5 S5 | 4.2 | 258 | 06.07 - | CAUA | 8 | PFR6W-TG | 5547 | | | |
| A 5 TDI | 2.0 | 100 | 09.09 - | CAGB | 4 | Y-609AS | 5849 | | D-POWER 49 | 5849 |
| A 5 TDI | 2.0 | 105 | 09.09 - | CAGA | 4 | Y-609AS | 5849 | | D-POWER 49 | 5849 |
| A 5 TDI | 2.0 | 105 | 05.10 - | CMEA | 4 | Y1002AS | 8888 | | D-POWER 57 | 8888 |
| A 5 TDI | 2.0 | 120 | 08.08 - | CAHB | 4 | Y-609AS | 5849 | | D-POWER 49 | 5849 |
| A 5 TDI | 2.0 | 125 | 08.08 - | CAHA | 4 | Y-609AS | 5849 | | D-POWER 49 | 5849 |
| A 5 TDI | 2.7 | 120 | 09.07 - 05.08 | CAMB | 6 | Y-609AS | 5849 | | D-POWER 49 | 5849 |

Fgst = Chassis No.



ℓ kW

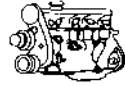

Cyl.

Order-
No. No.LPG/CNG
D-PowerOrder-
No.**AUDI**

| | | | | | | | | | | | | |
|---------|-----|-----|---------------|------|---|-----|------------|------|----|--|------------|------|
| A 5 TDI | 2.7 | 120 | 05.08 - | CGKB | 6 | █ | Y-609AS | 5849 | | | D-POWER 49 | 5849 |
| A 5 TDI | 2.7 | 140 | 07.07 - 05.08 | CAMA | 6 | █ | Y-609AS | 5849 | | | D-POWER 49 | 5849 |
| A 5 TDI | 2.7 | 140 | 05.08 - | CGKA | 6 | █ | Y-609AS | 5849 | | | D-POWER 49 | 5849 |
| A 5 TDI | 3.0 | 155 | 03.08 - 05.10 | CCWB | 6 | █ | Y-609AS | 5849 | | | D-POWER 49 | 5849 |
| A 5 TDI | 3.0 | 176 | 03.08 - | CCWA | 6 | █ | Y-609AS | 5849 | | | D-POWER 49 | 5849 |
| A 5 TDI | 3.0 | 177 | 06.07 - 05.08 | CAPA | 6 | █ | Y-609AS | 5849 | | | D-POWER 49 | 5849 |
| A 5 RS5 | 4.2 | 331 | 03.10 - | CFSA | 8 | 0,8 | PFR7S8EG | 1675 | | | | |
| A 6 | 1.8 | 92 | 10.95 - 10.97 | ADR | 4 | | BKUR6ET-10 | 2397 | 24 | | LPG 1 | 1496 |
| A 6 | 1.8 | 92 | 12.97 - 07.99 | AJP | 4 | | BKUR6ET-10 | 2397 | 24 | | LPG 1 | 1496 |
| A 6 | 1.8 | 92 | 01.99 - 04.01 | AQE | 4 | | BKUR6ET-10 | 2397 | 24 | | LPG 1 | 1496 |
| A 6 | 1.8 | 92 | 01.99 - 04.01 | ARH | 4 | | BKUR6ET-10 | 2397 | 24 | | LPG 1 | 1496 |
| A 6 | 1.8 | 110 | 04.97 - 01.99 | AEB | 4 | 0,8 | PFR6Q | 6458 | 37 | | LPG 1 | 1496 |
| A 6 | 1.8 | 110 | 01.99 - 05.01 | ANB | 4 | 0,8 | PFR6Q | 6458 | 37 | | LPG 1 | 1496 |
| A 6 | 1.8 | 110 | 11.98 - 05.01 | APU | 4 | 0,8 | PFR6Q | 6458 | 37 | | LPG 1 | 1496 |
| A 6 | 1.8 | 110 | 01.99 - 05.99 | ARK | 4 | 0,8 | PFR6Q | 6458 | 37 | | LPG 1 | 1496 |
| A 6 | 1.8 | 110 | 05.00 - 01.05 | AWT | 4 | 0,8 | PFR6Q | 6458 | 37 | | LPG 1 | 1496 |
| A 6 | 1.8 | 132 | 11.97 - 10.00 | AJL | 4 | 0,8 | PFR6Q | 6458 | 37 | | LPG 1 | 1496 |
| A 6 | 2.0 | 74 | 06.94 - 06.96 | AAE | 4 | | BUR6ET | 3172 | 1 | | LPG 2 | 1497 |
| A 6 | 2.0 | 79 | 06.96 - 10.97 | ADW | 4 | | BUR6ET | 3172 | 1 | | LPG 2 | 1497 |
| A 6 | 2.0 | 85 | 06.94 - 06.96 | ABK | 4 | | BUR6ET | 3172 | 1 | | LPG 2 | 1497 |
| A 6 | 2.0 | 96 | 06.01 - 01.05 | ALT | 4 | | BKUR5ET-10 | 7553 | | | LPG 1 | 1496 |
| A 6 | 2.0 | 103 | 06.94 - 10.97 | ACE | 4 | | BKUR7ET | 7873 | | | PFR7Q | 7963 |
| A 6 | 2.3 | 98 | 06.94 - 06.96 | AAR | 5 | | BPR5EKU | 5685 | | | LPG 2 | 1497 |
| A 6 | 2.4 | 99 | 08.97 - 01.99 | ALW | 6 | | BKR6EKUB | 3584 | | | LPG 1 | 1496 |
| A 6 | 2.4 | 100 | 02.99 - 05.00 | ARN | 6 | | BKR6EKUB | 3584 | | | LPG 1 | 1496 |
| A 6 | 2.4 | 100 | 06.00 - 01.05 | ASM | 6 | | BKR6EKUB | 3584 | | | LPG 1 | 1496 |
| A 6 | 2.4 | 120 | 04.97 - 01.99 | AJG | 6 | | BKR6EKUB | 3584 | | | LPG 1 | 1496 |
| A 6 | 2.4 | 120 | 06.00 - 04.01 | AMM | 6 | | BKR6EKUB | 3584 | | | LPG 1 | 1496 |
| A 6 | 2.4 | 120 | 11.98 - 05.01 | APZ | 6 | | BKR6EKUB | 3584 | | | LPG 1 | 1496 |
| A 6 | 2.4 | 121 | 04.97 - 01.99 | AGA | 6 | | BKR6EKUB | 3584 | | | LPG 1 | 1496 |
| A 6 | 2.4 | 121 | 06.97 - 01.99 | ALF | 6 | | BKR6EKUB | 3584 | | | LPG 1 | 1496 |
| A 6 | 2.4 | 121 | 06.00 - 05.01 | AML | 6 | | BKR6EKUB | 3584 | | | LPG 1 | 1496 |
| A 6 | 2.4 | 121 | 04.98 - 05.01 | APC | 6 | | BKR6EKUB | 3584 | | | LPG 1 | 1496 |
| A 6 | 2.4 | 121 | 11.98 - 05.01 | ARJ | 6 | | BKR6EKUB | 3584 | | | LPG 1 | 1496 |
| A 6 | 2.4 | 130 | 04.04 - | BDW | 6 | 1,1 | PFR6X-11 | 5757 | | | PFR6X-11 | 5757 |
| A 6 | 2.6 | 110 | 06.94 - 10.97 | ABC | 6 | | BKUR6ET-10 | 2397 | 24 | | LPG 1 | 1496 |
| A 6 | 2.7 | 169 | 09.00 - 05.01 | AZA | 6 | 0,8 | PFR6Q | 6458 | 37 | | LPG 1 | 1496 |
| A 6 | 2.7 | 184 | 07.02 - 08.05 | BES | 6 | 0,8 | PFR6Q | 6458 | 37 | | LPG 1 | 1496 |
| A 6 | 2.8 | 128 | 06.94 - 10.97 | AAH | 6 | | BKUR6ET-10 | 2397 | 24 | | LPG 1 | 1496 |
| A 6 | 2.8 | 128 | 08.94 - 06.95 | AFC | 6 | | BKUR6ET-10 | 2397 | 24 | | LPG 1 | 1496 |
| A 6 | 2.8 | 132 | 02.98 - 05.01 | AGE | 6 | | BKR6EKUB | 3584 | | | LPG 1 | 1496 |
| A 6 | 2.8 | 140 | 10.08 - | CCDA | 6 | 1,1 | PFR6X-11 | 5757 | | | PFR6X-11 | 5757 |
| A 6 | 2.8 | 142 | 10.95 - 07.98 | ACK | 6 | | BKR6EKUB | 3584 | | | LPG 1 | 1496 |
| A 6 | 2.8 | 142 | 06.97 - 01.99 | ALG | 6 | | BKR6EKUB | 3584 | | | LPG 1 | 1496 |
| A 6 | 2.8 | 142 | 06.00 - 05.01 | AMX | 6 | | BKR6EKUB | 3584 | | | LPG 1 | 1496 |
| A 6 | 2.8 | 142 | 11.98 - 05.01 | APR | 6 | | BKR6EKUB | 3584 | | | LPG 1 | 1496 |
| A 6 | 2.8 | 142 | 11.98 - 05.01 | AQD | 6 | | BKR6EKUB | 3584 | | | LPG 1 | 1496 |
| A 6 | 2.8 | 154 | 11.06 - | BDX | 6 | 1,1 | PFR6X-11 | 5757 | | | PFR6X-11 | 5757 |
| A 6 | 2.8 | 162 | 10.08 - | CCEA | 6 | 1,1 | PFR6X-11 | 5757 | | | PFR6X-11 | 5757 |
| A 6 | 3.0 | 162 | 06.01 - 01.05 | ASN | 6 | | BKR6EKUB | 3584 | | | LPG 1 | 1496 |
| A 6 | 3.2 | 188 | 10.08 - | BKH | 6 | 1,1 | PFR6X-11 | 5757 | | | PFR6X-11 | 5757 |
| A 6 | 3.2 | 195 | 05.09 - | CALA | 6 | 1,1 | PFR6X-11 | 5757 | | | PFR6X-11 | 5757 |



ℓ kW

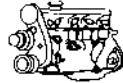

Cyl.

Order-
No.VLINE
No.LPG/CNG
D-PowerOrder-
No.**AUDI**

| | | | | | | | | | | | |
|-------------------|-----|-----|-------------|------|----|-----|------------|------|----|------------|------|
| A 6 | 3.7 | 191 | 10.98-02.01 | AQG | 8 | | BKR6EQU | 3199 | 30 | LPG 1 | 1496 |
| A 6 | 4.2 | 220 | 06.00-01.05 | ASG | 8 | | BKR6EQU | 3199 | 30 | LPG 1 | 1496 |
| A 6 | 4.2 | 220 | 04.03-08.05 | BAS | 8 | | BKR6EQUA | 6872 | | LPG 1 | 1496 |
| A 6 | 4.2 | 246 | 04.04-05.06 | BAT | 8 | | BKR6EQUA | 6872 | | LPG 1 | 1496 |
| A 6 | 4.2 | 257 | 05.06- | BVJ | 8 | | PFR6W-TG | 5547 | | | |
| A 6 (USA) | 2.8 | 142 | 08.97-07.99 | AHA | 6 | | BKR6EKUB | 3584 | | LPG 1 | 1496 |
| A 6 (USA) | 4.2 | 220 | 04.99-05.00 | ART | 8 | | BKR6EQU | 3199 | 30 | LPG 1 | 1496 |
| A 6 (China / GUS) | 2.6 | 102 | 06.94-10.97 | ACZ | 6 | | BKUR6ET-10 | 2397 | 24 | LPG 1 | 1496 |
| A 6 China | 2.4 | 110 | 07.95-10.97 | AFM | 6 | | BKUR6ET-10 | 2397 | 24 | LPG 1 | 1496 |
| A 6 China | 2.4 | 121 | 11.98-05.01 | APS | 6 | | BKR6EKUB | 3584 | | LPG 1 | 1496 |
| A 6 China | 2.4 | 125 | 06.01-01.05 | BDV | 6 | | BKR6EKUB | 3584 | | LPG 1 | 1496 |
| A 6 China | 2.8 | 140 | 07.99-05.01 | ATX | 6 | | BKR6EKUB | 3584 | | LPG 1 | 1496 |
| A 6 China | 3.0 | 160 | 06.01-05.06 | BBJ | 6 | | BKR6EKUB | 3584 | | LPG 1 | 1496 |
| A 6 (GUS) | 1.8 | 85 | 05.97-05.00 | AFY | 4 | | BKUR6ET-10 | 2397 | 24 | LPG 1 | 1496 |
| A 6 (GUS) | 2.8 | 120 | 07.96-10.97 | AEJ | 6 | 0,8 | PFR5B | 5341 | | PFR6B | 3500 |
| A 6 4.2 | 4.2 | 221 | 04.99-05.01 | ARS | 8 | | BKR6EQU | 3199 | 30 | LPG 1 | 1496 |
| A 6 FSI | 3.2 | 188 | 04.04- | AUK | 6 | | PFR7W-T | 6840 | | PFR7W-T | 6840 |
| A 6 RS 6 | 4.2 | 331 | 07.02-09.04 | BCY | 8 | | PFR7Q | 7963 | | PFR7Q | 7963 |
| A 6 RS 6 | 4.2 | 353 | 04.04-09.04 | BRV | 8 | | PFR7Q | 7963 | | PFR7Q | 7963 |
| A 6 S 6 | 2.2 | 169 | 06.94-07.97 | AAN | 5 | 0,6 | PFR7B | 4853 | | PFR8B | 2781 |
| A 6 S 6 | 4.2 | 250 | 09.00-01.05 | ANK | 8 | | BKR6EQU | 3199 | 30 | LPG 1 | 1496 |
| A 6 S 6 | 4.2 | 250 | 09.99-05.01 | AQJ | 8 | | BKR6EQU | 3199 | 30 | LPG 1 | 1496 |
| A 6 S 6 | 5.2 | 320 | 06.06- | BXA | 10 | | PFR6W-TG | 5547 | | | |
| A 6 S 6 4.2 | 4.2 | 213 | 09.94-10.97 | AEC | 8 | 0,8 | BUR6EFSZ | 6837 | | | |
| A 6 S 6 Plus | 4.2 | 235 | 06.96-10.97 | AHK | 8 | 0,8 | BUR6EFSZ | 6837 | | | |
| A 6 TDI | 1.9 | 66 | 07.94-06.96 | 1Z | 4 | █ | Y-732J | 5605 | | D-POWER 4 | 5605 |
| A 6 TDI | 1.9 | 66 | 07.96-10.97 | AHU | 4 | █ | Y-732J | 5605 | | D-POWER 4 | 5605 |
| A 6 TDI | 1.9 | 81 | 04.97-04.01 | AFN | 4 | █ | Y-732J | 5605 | | D-POWER 4 | 5605 |
| A 6 TDI | 1.9 | 81 | 08.99-10.00 | AVG | 4 | █ | Y-732J | 5605 | | D-POWER 4 | 5605 |
| A 6 TDI | 1.9 | 85 | 11.00-04.01 | AJM | 4 | █ | Y-741U | 6943 | | D-POWER 20 | 6943 |
| A 6 TDI | 1.9 | 96 | 06.01-01.05 | AVF | 4 | █ | Y-732J | 5605 | | D-POWER 4 | 5605 |
| A 6 TDI | 1.9 | 96 | 06.01-01.05 | AWX | 4 | █ | Y-741U | 6943 | | D-POWER 20 | 6943 |
| A 6 TDI | 2.0 | 89 | 09.05-06.06 | BVG | 4 | █ | CZ304 | 9864 | | D-POWER 55 | 9864 |
| A 6 TDI | 2.0 | 100 | 07.04-11.05 | BNA | 4 | █ | YE14 | 7768 | | D-POWER 48 | 7768 |
| A 6 TDI | 2.0 | 100 | 09.05- | BRF | 4 | █ | CZ304 | 9864 | | D-POWER 55 | 9864 |
| A 6 TDI | 2.0 | 100 | 10.08- | CAGB | 4 | █ | Y-609AS | 5849 | | D-POWER 49 | 5849 |
| A 6 TDI | 2.0 | 103 | 07.04-11.05 | BLB | 4 | █ | YE14 | 7768 | | D-POWER 48 | 7768 |
| A 6 TDI | 2.0 | 103 | 09.05- | BRE | 4 | █ | CZ304 | 9864 | | D-POWER 55 | 9864 |
| A 6 TDI | 2.0 | 120 | 04.09- | CAHB | 4 | █ | Y-609AS | 5849 | | D-POWER 49 | 5849 |
| A 6 TDI | 2.0 | 125 | 11.08- | CAHA | 4 | █ | Y-609AS | 5849 | | D-POWER 49 | 5849 |
| A 6 TDI | 2.5 | 85 | 06.94-10.97 | AAT | 5 | █ | Y-732J | 5605 | | D-POWER 4 | 5605 |
| A 6 TDI | 2.5 | 103 | 10.94-10.97 | AEL | 5 | █ | Y-732J | 5605 | | D-POWER 4 | 5605 |
| A 6 TDI | 2.5 | 110 | 04.97-05.00 | AFB | 6 | █ | Y-501U | 3786 | | D-POWER 31 | 4187 |
| A 6 TDI | 2.5 | 110 | 10.98-05.01 | AKN | 6 | █ | Y-501U | 3786 | | D-POWER 31 | 4187 |
| A 6 TDI | 2.5 | 114 | 06.01-06.02 | AYM | 6 | █ | Y-501U | 3786 | | D-POWER 31 | 4187 |
| A 6 TDI | 2.5 | 120 | 02.03-08.05 | BCZ | 6 | █ | Y-501U | 3786 | | D-POWER 31 | 4187 |
| A 6 TDI | 2.5 | 120 | 02.03-01.05 | BDG | 6 | █ | Y-501U | 3786 | | D-POWER 31 | 4187 |
| A 6 TDI | 2.5 | 120 | 07.02-08.03 | BFC | 6 | █ | Y-501U | 3786 | | D-POWER 31 | 4187 |
| A 6 TDI | 2.5 | 132 | 11.99-08.03 | AKE | 6 | █ | Y-501U | 3786 | | D-POWER 31 | 4187 |
| A 6 TDI | 2.5 | 132 | 02.03-08.05 | BAU | 6 | █ | Y-501U | 3786 | | D-POWER 31 | 4187 |
| A 6 TDI | 2.5 | 132 | 02.03-01.05 | BDH | 6 | █ | Y-501U | 3786 | | D-POWER 31 | 4187 |
| A 6 TDI | 2.7 | 120 | 10.08- | CANB | 6 | █ | Y-609AS | 5849 | | D-POWER 49 | 5849 |



ℓ kW

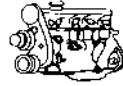

Cyl.

Order-
No. No.LPG/CNG
D-PowerOrder-
No.**AUDI**

| | | | | | | | | | | |
|-------------------|-----|-----|---------------|------|----|---------------|------|----|------------|------|
| A 6 TDI | 2.7 | 120 | 10.08 - | CAND | 6 | Y-609AS | 5849 | | D-POWER 49 | 5849 |
| A 6 TDI | 2.7 | 130 | 11.04 - | BPP | 6 | Y-609AS | 5849 | | D-POWER 49 | 5849 |
| A 6 TDI | 2.7 | 140 | 10.08 - | CANA | 6 | Y-609AS | 5849 | | D-POWER 49 | 5849 |
| A 6 TDI | 2.7 | 140 | 10.08 - | CANC | 6 | Y-609AS | 5849 | | D-POWER 49 | 5849 |
| A 6 TDI | 3.0 | 155 | 03.05 - 10.08 | BNG | 6 | Y-609AS | 5849 | | D-POWER 49 | 5849 |
| A 6 TDI | 3.0 | 155 | 10.08 - | CDYB | 6 | Y-609AS | 5849 | | D-POWER 49 | 5849 |
| A 6 TDI | 3.0 | 165 | 04.04 - 05.06 | BMK | 6 | Y-609AS | 5849 | | D-POWER 49 | 5849 |
| A 6 TDI | 3.0 | 171 | 05.06 - | ASB | 6 | Y-609AS | 5849 | | D-POWER 49 | 5849 |
| A 6 TDI | 3.0 | 176 | 10.08 - | CDYA | 6 | Y-609AS | 5849 | | D-POWER 49 | 5849 |
| A 6 TDI | 3.0 | 176 | 10.08 - | CDYC | 6 | Y-609AS | 5849 | | D-POWER 49 | 5849 |
| A 6 TDI (B) | 2.7 | 120 | 06.05 - | BSG | 6 | Y-609AS | 5849 | | D-POWER 49 | 5849 |
| A 6 TFSI China | 2.0 | 125 | 06.05 - | BPJ | 4 | 0,8 PFR7S8EG | 1675 | | | |
| A 6 biturbo | 2.7 | 169 | 02.99 - 08.00 | AJK | 6 | 0,8 PFR6Q | 6458 | 37 | LPG 1 | 1496 |
| A 6 biturbo | 2.7 | 184 | 05.00 - 06.02 | ARE | 6 | 0,8 PFR6Q | 6458 | 37 | LPG 1 | 1496 |
| A 6 biturbo (USA) | 2.7 | 187 | 05.99 - 06.02 | APB | 6 | 0,8 PFR6Q | 6458 | 37 | LPG 1 | 1496 |
| A 8 | 2.8 | 120 | 07.95 - 03.96 | AEJ | 6 | 0,8 PFR5B | 5341 | | PFR6B | 3500 |
| A 8 | 2.8 | 128 | 06.94 - 03.96 | AAH | 6 | BKUR6ET-10 | 2397 | 24 | LPG 1 | 1496 |
| A 8 | 2.8 | 142 | 04.96 - 09.98 | ACK | 6 | BKR6EKUB | 3584 | | LPG 1 | 1496 |
| A 8 | 2.8 | 142 | 05.00 - 09.02 | AMX | 6 | BKR6EKUB | 3584 | | LPG 1 | 1496 |
| A 8 | 2.8 | 142 | 01.99 - 02.01 | APR | 6 | BKR6EKUB | 3584 | | LPG 1 | 1496 |
| A 8 | 2.8 | 142 | 01.99 - 02.01 | AQD | 6 | BKR6EKUB | 3584 | | LPG 1 | 1496 |
| A 8 | 2.8 | 154 | 09.07 - | BDX | 6 | 1,1 PFR6X-11 | 5757 | | PFR6X-11 | 5757 |
| A 8 | 3.0 | 160 | 07.03 - 05.06 | BBJ | 6 | BKR6EKUB | 3584 | | LPG 1 | 1496 |
| A 8 | 3.0 | 162 | 07.03 - 05.05 | ASN | 6 | BKR6EKUB | 3584 | | LPG 1 | 1496 |
| A 8 | 3.2 | 191 | 06.05 - | BPK | 6 | PFR7W-T | 6840 | | PFR7W-T | 6840 |
| A 8 | 3.7 | 169 | 07.95 - 12.98 | AEW | 8 | 0,8 BUR6EFSZ | 6837 | | | |
| A 8 | 3.7 | 169 | 05.97 - 12.98 | AKJ | 8 | 0,8 BUR6EFSZ | 6837 | | | |
| A 8 | 3.7 | 191 | 05.00 - 09.02 | AKC | 8 | BKR6EQUP | 3199 | 30 | LPG 1 | 1496 |
| A 8 | 3.7 | 191 | 10.98 - 02.01 | AQG | 8 | BKR6EQUP | 3199 | 30 | LPG 1 | 1496 |
| A 8 | 3.7 | 206 | 11.02 - 05.06 | BFL | 8 | BKR6EQUA | 6872 | | LPG 1 | 1496 |
| A 8 | 4.2 | 175 | 02.99 - 04.00 | ARU | 8 | BKR6EQUP | 3199 | 30 | LPG 1 | 1496 |
| A 8 | 4.2 | 210 | 06.94 - 12.98 | AGH | 8 | 0,8 BUR6EFSZ | 6837 | | | |
| A 8 | 4.2 | 220 | 06.97 - 12.98 | AKG | 8 | 0,8 BUR6EFSZ | 6837 | | | |
| A 8 | 4.2 | 228 | 10.98 - 02.01 | AQF | 8 | BKR6EQUP | 3199 | 30 | LPG 1 | 1496 |
| A 8 | 4.2 | 228 | 05.00 - 09.02 | AUW | 8 | BKR6EQUP | 3199 | 30 | LPG 1 | 1496 |
| A 8 | 4.2 | 246 | 11.02 - 05.06 | BFM | 8 | BKR6EQUA | 6872 | | LPG 1 | 1496 |
| A 8 | 4.2 | 257 | 08.98 - | AKD | 8 | BKR6EQUP | 3199 | 30 | LPG 1 | 1496 |
| A 8 | 4.2 | 257 | 06.06 - | BVJ | 8 | PFR6W-TG | 5547 | | | |
| A 8 | 4.2 | 273 | 11.09 - | CDRA | 8 | PFR6W-TG | 5547 | | | |
| A 8 | 6.0 | 309 | 03.01 - 09.02 | AZC | 12 | 1,1 PZFR6J-11 | 3586 | | LPG 6 | 1565 |
| A 8 | 6.0 | 331 | 02.04 - | BHT | 12 | 1,1 PZFR6J-11 | 3586 | | LPG 6 | 1565 |
| A 8 (CH) | 6.0 | 331 | 02.05 - | BTE | 12 | 1,1 PZFR6J-11 | 3586 | | LPG 6 | 1565 |
| A 8 (USA) | 4.2 | 228 | 05.99 - 05.00 | AKB | 8 | BKR6EQUP | 3199 | 30 | LPG 1 | 1496 |
| A 8 4.2 | 4.2 | 180 | 06.94 - 07.96 | AEM | 8 | 0,8 BUR6EFSZ | 6837 | | | |
| A 8 4.2 | 4.2 | 220 | 06.94 - 05.99 | ABZ | 8 | 0,8 BUR6EFSZ | 6837 | | | |
| A 8 S 8 | 4.2 | 250 | 09.96 - 12.98 | AHC | 8 | 0,8 BUR6EFSZ | 6837 | | | |
| A 8 S 8 | 4.2 | 250 | 08.97 - 12.98 | AKH | 8 | 0,8 BUR6EFSZ | 6837 | | | |
| A 8 S 8 | 4.2 | 265 | 05.99 - 02.01 | AQH | 8 | BKR6EQUP | 3199 | 30 | LPG 1 | 1496 |
| A 8 S 8 | 4.2 | 265 | 09.00 - 09.02 | AVP | 8 | BKR6EQUP | 3199 | 30 | LPG 1 | 1496 |
| A 8 S 8 | 4.2 | 265 | 02.01 - 09.02 | AYS | 8 | BKR6EQUP | 3199 | 30 | LPG 1 | 1496 |
| A 8 S 8 | 4.2 | 265 | 09.00 - 02.01 | BCS | 8 | BKR6EQUP | 3199 | 30 | LPG 1 | 1496 |
| A 8 S 8 | 5.2 | 331 | 06.06 - | BSM | 10 | PFR6W-TG | 5547 | | | |



ℓ kW

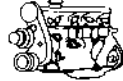

Cyl.

Order-
No.VLINE
No.LPG/CNG
D-PowerOrder-
No.**AUDI**

| | | | | | | | | | | | |
|-----------------------------|-----|-----|--------------|------|---|-----|------------|------|----|------------|------|
| A 8 TDI | 2.5 | 110 | 06.97 -04.00 | AFB | 6 | █ | Y-501U | 3786 | | D-POWER 31 | 4187 |
| A 8 TDI | 2.5 | 110 | 11.97 -09.02 | AKN | 6 | █ | Y-501U | 3786 | | D-POWER 31 | 4187 |
| A 8 TDI | 2.5 | 132 | 11.99 -09.02 | AKE | 6 | █ | Y-501U | 3786 | | D-POWER 31 | 4187 |
| A 8 TDI | 3.3 | 165 | 12.99 -09.02 | AKF | 8 | █ | Y-501U | 3786 | | D-POWER 31 | 4187 |
| A 8 TDI | 4.0 | 202 | 05.03 -07.05 | ASE | 8 | █ | Y-501U | 3786 | | D-POWER 31 | 4187 |
| A 8 TDI | 4.2 | 235 | 01.05 -06.05 | BMC | 8 | █ | Y-609AS | 5849 | | D-POWER 49 | 5849 |
| A 8 TDI | 4.2 | 240 | 07.05 - | BVN | 8 | █ | Y-609AS | 5849 | | D-POWER 49 | 5849 |
| A 8 TDI | 4.2 | 258 | 11.09 - | CDSB | 8 | █ | Y-609AS | 5849 | | D-POWER 49 | 5849 |
| A 8 TDI Fgst 4E-5-003 301 → | 3.0 | 155 | 11.03 - | BNG | 6 | █ | Y-609AS | 5849 | | D-POWER 49 | 5849 |
| A 8 TDI Fgst 4E-5-003 301 → | 3.0 | 171 | 01.04 - | ASB | 6 | █ | Y-609AS | 5849 | | D-POWER 49 | 5849 |
| A 8 V6 | 2.8 | 142 | 10.97 -12.98 | ALG | 6 | | BKR6EKUB | 3584 | | LPG 1 | 1496 |
| Cabrio | 1.8 | 92 | 04.97 -08.00 | ADR | 4 | | BKUR6ET-10 | 2397 | 24 | LPG 1 | 1496 |
| Cabrio | 1.9 | 66 | 07.95 -07.96 | 1Z | 4 | █ | Y-732J | 5605 | | D-POWER 4 | 5605 |
| Cabrio | 1.9 | 66 | 07.96 -08.00 | AHU | 4 | █ | Y-732J | 5605 | | D-POWER 4 | 5605 |
| Cabrio | 2.0 | 85 | 01.93 -09.98 | ABK | 4 | | BUR6ET | 3172 | 1 | LPG 2 | 1497 |
| Cabrio | 2.0 | 103 | 05.95 -07.96 | ACE | 4 | | BKUR7ET | 7873 | | PFR7Q | 7963 |
| Cabrio | 2.3 | 98 | 06.91 -07.94 | NG | 5 | | BPR5EKU | 5685 | | LPG 2 | 1497 |
| Cabrio | 2.6 | 110 | 01.94 -08.00 | ABC | 6 | | BKUR6ET-10 | 2397 | 24 | LPG 1 | 1496 |
| Cabrio | 2.8 | 128 | 11.92 -08.00 | AAH | 6 | | BKUR6ET-10 | 2397 | 24 | LPG 1 | 1496 |
| Cabrio (China / GUS) | 2.6 | 102 | 05.95 -12.99 | ACZ | 6 | | BKUR6ET-10 | 2397 | 24 | LPG 1 | 1496 |
| Coupe | 1.6 | 55 | 08.81 -07.82 | DD | 4 | 0,7 | BP6ES | 7811 | 4 | LPG 2 | 1497 |
| Coupe | 1.8 | 64 | 02.86 -07.87 | SF | 4 | | BUR6ET | 3172 | 1 | LPG 2 | 1497 |
| Coupe | 1.8 | 66 | 08.82 -07.88 | DS | 4 | | BUR6ET | 3172 | 1 | LPG 2 | 1497 |
| Coupe | 1.8 | 66 | 01.85 -07.88 | JN | 4 | | BUR6ET | 3172 | 1 | LPG 2 | 1497 |
| Coupe | 1.8 | 81 | 08.86 -07.88 | PV | 4 | | BUR6ET | 3172 | 1 | LPG 2 | 1497 |
| Coupe | 1.8 | 82 | 08.86 -07.91 | DZ | 4 | | BUR6ET | 3172 | 1 | LPG 2 | 1497 |
| Coupe | 1.9 | 85 | 10.80 -07.83 | WN | 4 | 0,8 | BP7ES | 2412 | | BPR8EIX | 6684 |
| Coupe | 2.0 | 81 | 08.83 -07.88 | JL | 4 | | BUR6ET | 3172 | 1 | LPG 2 | 1497 |
| Coupe | 2.0 | 83 | 05.89 -07.90 | 3A | 4 | | BUR6ET | 3172 | 1 | LPG 2 | 1497 |
| Coupe | 2.0 | 83 | 02.86 -07.86 | SK | 4 | | BUR6ET | 3172 | 1 | LPG 2 | 1497 |
| Coupe | 2.0 | 85 | 08.90 -07.91 | AAD | 4 | | BUR6ET | 3172 | 1 | LPG 2 | 1497 |
| Coupe | 2.0 | 85 | 08.91 -12.95 | ABK | 4 | | BUR6ET | 3172 | 1 | LPG 2 | 1497 |
| Coupe | 2.0 | 85 | 08.83 -07.86 | HP | 4 | | BUR6ET | 3172 | 1 | LPG 2 | 1497 |
| Coupe | 2.0 | 85 | 08.83 -07.86 | JS | 5 | | BUR6ET | 3172 | 1 | LPG 2 | 1497 |
| Coupe | 2.0 | 101 | 03.90 -07.92 | 6A | 4 | | BKUR7ET | 7873 | | PFR7Q | 7963 |
| Coupe | 2.0 | 103 | 08.92 -12.95 | ACE | 4 | | BKUR7ET | 7873 | | PFR7Q | 7963 |
| Coupe | 2.0 | 118 | 11.88 -07.91 | NM | 4 | | BCPR7ET | 2164 | | BCPR7EIX | 5690 |
| Coupe | 2.2 | 85 | 01.85 -07.88 | KX | 5 | | BUR6ET | 3172 | 1 | LPG 2 | 1497 |
| Coupe | 2.2 | 96 | 08.81 -07.84 | KE | 5 | | BUR6ET | 3172 | 1 | LPG 2 | 1497 |
| Coupe | 2.2 | 96 | 08.82 -07.84 | KL | 5 | | BUR6ET | 3172 | 1 | LPG 2 | 1497 |
| Coupe | 2.2 | 100 | 08.84 -07.88 | HY | 5 | | BUR6ET | 3172 | 1 | LPG 2 | 1497 |
| Coupe | 2.2 | 100 | 08.84 -07.91 | KV | 5 | | BUR6ET | 3172 | 1 | LPG 2 | 1497 |
| Coupe | 2.3 | 98 | 08.86 -07.94 | NG | 5 | | BPR5EKU | 5685 | | LPG 2 | 1497 |
| Coupe | 2.3 | 125 | 11.88 -07.91 | 7A | 5 | | BKUR7ET | 7873 | | PFR7Q | 7963 |
| Coupe | 2.6 | 110 | 08.92 -12.95 | ABC | 6 | | BKUR6ET-10 | 2397 | 24 | LPG 1 | 1496 |
| Coupe | 2.8 | 128 | 08.91 -12.95 | AAH | 6 | | BKUR6ET-10 | 2397 | 24 | LPG 1 | 1496 |
| Coupe (China) | 1.8 | 66 | 01.85 -07.87 | JV | 4 | | BUR6ET | 3172 | 1 | LPG 2 | 1497 |
| Coupe S2 | 2.2 | 162 | 09.90 -09.92 | 3B | 5 | 0,6 | PFR7B | 4853 | | PFR8B | 2781 |
| Coupe S2 | 2.2 | 169 | 10.92 -12.95 | ABY | 5 | 0,6 | PFR7B | 4853 | | PFR8B | 2781 |
| Q 5 | 2.0 | 132 | 08.09 - | CDNB | 4 | 0,8 | PFR7S8EG | 1675 | | | |
| Q 5 | 2.0 | 155 | 05.10 - | CAEB | 4 | 0,8 | PFR7S8EG | 1675 | | | |
| Q 5 TDI | 2.0 | 100 | 08.09 - | CAGB | 4 | █ | Y-609AS | 5849 | | D-POWER 49 | 5849 |

Fgst = Chassis No.



ℓ kW



Cyl.

Order-
No. No.LPG/CNG
D-PowerOrder-
No.**AUDI**

| | | | | | | | | | | |
|----------------|-----|-----|---------------|------|----|--------------|------|----|------------|------|
| Q 5 TDI | 2.0 | 105 | 08.09 - | CAGA | 4 | Y-609AS | 5849 | | D-POWER 49 | 5849 |
| Q 5 TDI | 2.0 | 100 | 05.10 - | CJCB | 4 | Y1002AS | 8888 | | D-POWER 57 | 8888 |
| Q 5 TDI | 2.0 | 105 | 05.10 - | CJCA | 4 | Y1002AS | 8888 | | D-POWER 57 | 8888 |
| Q 5 TDI | 2.0 | 120 | 11.08 - 09.10 | CAHB | 4 | Y-609AS | 5849 | | D-POWER 49 | 5849 |
| Q 5 TDI | 2.0 | 120 | 05.10 - | CGLA | 4 | Y1002AS | 8888 | | D-POWER 57 | 8888 |
| Q 5 TDI | 2.0 | 125 | 11.08 - 09.10 | CAHA | 4 | Y-609AS | 5849 | | D-POWER 49 | 5849 |
| Q 5 TDI | 2.0 | 125 | 05.10 - | CGLB | 4 | Y1002AS | 8888 | | D-POWER 57 | 8888 |
| Q 5 TDI | 2.0 | 125 | 11.10 - | CMGA | 4 | Y1002AS | 8888 | | D-POWER 57 | 8888 |
| Q 5 TDI | 3.0 | 155 | 11.08 - | CCWB | 6 | Y-609AS | 5849 | | D-POWER 49 | 5849 |
| Q 5 TDI | 3.0 | 176 | 11.08 - | CCWA | 6 | Y-609AS | 5849 | | D-POWER 49 | 5849 |
| Q 5 TFSI | 2.0 | 130 | 09.09 - | CDNA | 4 | 0,8 PFR7S8EG | 1675 | | | |
| Q 5 TFSI | 2.0 | 155 | 11.08 - | CDNC | 4 | 0,8 PFR7S8EG | 1675 | | | |
| Q 7 FSI | 3.6 | 206 | 08.06 - | BHK | 6 | 0,9 ILZKR7A | 1961 | | ILZKR7A | 1961 |
| Q 7 FSI | 4.2 | 257 | 03.06 - | BAR | 8 | PFR6W-TG | 5547 | | | |
| Q 7 TDI | 3.0 | 155 | 03.06 - | BUN | 6 | Y-609AS | 5849 | | D-POWER 49 | 5849 |
| Q 7 TDI | 3.0 | 155 | 11.07 - 05.10 | CASB | 6 | Y-609AS | 5849 | | D-POWER 49 | 5849 |
| Q 7 TDI | 3.0 | 171 | 03.06 - | BUG | 6 | Y-609AS | 5849 | | D-POWER 49 | 5849 |
| Q 7 TDI | 3.0 | 177 | 11.07 - 05.10 | CASA | 6 | Y-609AS | 5849 | | D-POWER 49 | 5849 |
| Q 7 TDI | 4.2 | 230 | 03.07 - | BTR | 8 | Y-609AS | 5849 | | D-POWER 49 | 5849 |
| Q 7 TDI | 4.2 | 250 | 06.09 - 05.10 | CCFA | 8 | Y-609AS | 5849 | | D-POWER 49 | 5849 |
| Q 7 TDI | 6.0 | 368 | 09.08 - | CCGA | 12 | Y-609AS | 5849 | | D-POWER 49 | 5849 |
| Quattro | 2.2 | 147 | 07.80 - 07.87 | GV | 5 | 0,6 PFR7B | 4853 | | PFR8B | 2781 |
| Quattro | 2.2 | 147 | 08.87 - 07.89 | MB | 5 | BUR6ET | 3172 | 1 | LPG 2 | 1497 |
| Quattro | 2.2 | 147 | 07.80 - 07.87 | WR | 5 | 0,6 PFR7B | 4853 | | PFR8B | 2781 |
| Quattro | 2.2 | 162 | 08.89 - 07.91 | RR | 5 | 0,6 PFR7B | 4853 | | PFR8B | 2781 |
| R 8 | 4.2 | 309 | 04.07 - | BYH | 8 | PFR7W-TG | 5592 | | PFR7W-TG | 5592 |
| R 8 | 5.2 | 386 | 04.09 - | BUJ | 10 | PFR7W-TG | 5592 | | PFR7W-TG | 5592 |
| TT / TTS | 1.8 | 110 | 01.01 - 06.06 | AUM | 4 | 0,8 PFR6Q | 6458 | 37 | LPG 1 | 1496 |
| TT / TTS | 1.8 | 118 | 06.08 - | CDAA | 4 | 0,8 PFR7S8EG | 1675 | | | |
| TT / TTS | 1.8 | 120 | 09.05 - 06.06 | BVP | 4 | 0,8 PFR6Q | 6458 | 37 | LPG 1 | 1496 |
| TT / TTS | 1.8 | 132 | 10.98 - 08.00 | AJQ | 4 | 0,8 PFR6Q | 6458 | 37 | LPG 1 | 1496 |
| TT / TTS | 1.8 | 132 | 09.99 - 09.00 | APP | 4 | 0,8 PFR6Q | 6458 | 37 | LPG 1 | 1496 |
| TT / TTS | 1.8 | 132 | 09.00 - 05.05 | ARY | 4 | 0,8 PFR6Q | 6458 | 37 | LPG 1 | 1496 |
| TT / TTS | 1.8 | 132 | 09.00 - 06.06 | AUQ | 4 | 0,8 PFR6Q | 6458 | 37 | LPG 1 | 1496 |
| TT / TTS | 1.8 | 140 | 09.05 - 06.06 | BVR | 4 | 0,8 PFR6Q | 6458 | 37 | LPG 1 | 1496 |
| TT / TTS | 1.8 | 165 | 10.98 - 08.01 | APX | 4 | 0,8 PFR6Q | 6458 | 37 | LPG 1 | 1496 |
| TT / TTS | 1.8 | 165 | 09.00 - 05.05 | BAM | 4 | 0,8 PFR6Q | 6458 | 37 | LPG 1 | 1496 |
| TT / TTS | 1.8 | 180 | 03.05 - 05.05 | BFV | 4 | 0,8 PFR6Q | 6458 | 37 | LPG 1 | 1496 |
| TT / TTS | 2.0 | 125 | 06.08 - 06.10 | CBBB | 4 | Y-609AS | 5849 | | D-POWER 49 | 5849 |
| TT / TTS | 2.0 | 125 | 05.10 - | CFGB | 4 | Y1002AS | 8888 | | D-POWER 57 | 8888 |
| TT / TTS | 2.0 | 147 | 08.06 - | BWA | 4 | 0,8 PFR7S8EG | 1675 | | | |
| TT / TTS | 2.0 | 147 | 06.08 - 06.10 | CCZA | 4 | 0,8 PFR7S8EG | 1675 | | | |
| TT / TTS | 2.0 | 155 | 05.10 - | CESA | 4 | 0,8 PFR7S8EG | 1675 | | | |
| TT / TTS | 2.0 | 155 | 05.10 - | CETA | 4 | 0,8 PFR7S8EG | 1675 | | | |
| TT / TTS | 2.0 | 195 | 05.08 - | CDLA | 4 | 0,8 PFR7S8EG | 1675 | | | |
| TT / TTS | 2.0 | 195 | 05.10 - | CDMA | 4 | 0,8 PFR7S8EG | 1675 | | | |
| TT / TTS | 2.0 | 200 | 05.08 - | CDLB | 4 | 0,8 PFR7S8EG | 1675 | | | |
| TT / TTS | 3.2 | 184 | 07.03 - 06.06 | BHE | 6 | 0,9 IZKR7B | 7563 | | IZKR7B | 7563 |
| TT / TTS | 3.2 | 184 | 08.06 - | BUB | 6 | 0,9 IZKR7B | 7563 | | IZKR7B | 7563 |
| TT / TTS (USA) | 1.8 | 132 | 09.00 - 06.06 | AWP | 4 | 0,8 PFR6Q | 6458 | 37 | LPG 1 | 1496 |
| TT / TTS (USA) | 1.8 | 165 | 03.00 - 08.02 | AMU | 4 | 0,8 PFR6Q | 6458 | 37 | LPG 1 | 1496 |
| TT Quattro | 2.0 | 125 | 06.08 - | CBBB | 4 | Y1002AS | 8888 | | D-POWER 57 | 8888 |



ℓ kW



Cyl.

Order-
No. No.LPG/CNG
D-PowerOrder-
No.**AUDI**

| | | | | | | | | | | | | |
|---------|-----|-----|---------------|-----|---|-----|----------|------|--|--|--|--|
| V 8 3.6 | 3.6 | 184 | 10.88 - 11.93 | PT | 8 | 0,8 | BUR6EFSZ | 6837 | | | | |
| V 8 4.2 | 4.2 | 206 | 08.91 - 11.93 | ABH | 8 | 0,8 | BUR6EFSZ | 6837 | | | | |

AUSTIN

| | | | | | | | | | | | | |
|-------------|-----|----|---------------|-----------|---|-----|---------|------|----|----------|--|------|
| Austin TAXI | | | 08.83 - | | 4 | █ | Y-208T | 1250 | | | | |
| Ital | 1.3 | | 80 - 84 | | 4 | 0,7 | BP6ES | 7811 | 4 | LPG 2 | | 1497 |
| Ital | 1.7 | | 80 - 84 | | 4 | 0,9 | BP6EF | 4666 | | | | |
| Ital | 2.0 | | 80 - 84 | | 4 | 0,9 | BP6EF | 4666 | | | | |
| Maestro | 1.3 | | 03.83 - 07.89 | A-PLUS | 4 | 0,8 | BPR6ES | 7822 | 2 | LPG 2 | | 1497 |
| Maestro | 1.6 | | 03.83 - 05.84 | R-Serie | 4 | 0,7 | BP6ES | 7811 | 4 | LPG 2 | | 1497 |
| Maestro | 1.6 | | 05.84 - 07.89 | S-Serie | 4 | 0,8 | BCPR6ES | 2330 | 12 | LPG 3 | | 1498 |
| Maestro (D) | 1.6 | | 05.84 - 07.89 | S-Serie | 4 | 0,9 | BCP7ES | 5030 | | BCPR7EIX | | 5690 |
| Metro | | | 10.84 - 04.90 | | 4 | 0,7 | BP6ES | 7811 | 4 | LPG 2 | | 1497 |
| Metro | 1.0 | | 01.87 - 01.90 | | 4 | 0,8 | BP5ES | 6511 | 8 | LPG 2 | | 1497 |
| Metro | 1.0 | | 01.90 - 09.90 | | 4 | 0,9 | BPR5ES | 7422 | 6 | LPG 2 | | 1497 |
| Metro | 1.0 | | 10.80 - 12.86 | | 4 | 0,7 | BP6ES | 7811 | 4 | LPG 2 | | 1497 |
| Metro | 1.3 | | 10.80 - 04.92 | | 4 | 0,8 | BPR6ES | 7822 | 2 | LPG 2 | | 1497 |
| Metro 310 | 1.0 | | 09.89 - 04.92 | | 4 | 0,7 | BP6ES | 7811 | 4 | LPG 2 | | 1497 |
| Metro 310 | 1.3 | | 09.89 - 04.92 | | 4 | 0,8 | BPR6ES | 7822 | 2 | LPG 2 | | 1497 |
| Mini | | | 07.89 - 10.89 | ERA Turbo | 4 | 0,8 | BPR7ES | 2023 | 19 | BPR7EIX | | 4055 |
| Mini | | | 01.87 - 10.89 | not Turbo | 4 | 0,8 | BP5ES | 6511 | 8 | LPG 2 | | 1497 |
| Mini | 1.0 | 31 | 09.86 - 08.88 | | 4 | 0,7 | BP6ES | 7811 | 4 | LPG 2 | | 1497 |

AUTOBIANCHI

| | | | | | | | | | | | | |
|------------------------------|------|----|---------------|----------------|---|-----|---------|------|----|--------|--|------|
| Y10 Fire | 1.0 | 32 | 10.87 - 09.92 | 156A2.100 Cat. | 4 | 0,8 | BCPR6ES | 2330 | 12 | LPG 3 | | 1498 |
| Y10 Fire IE alle Modelle | 1.1 | 41 | 01.89 - 10.96 | 156C000 | 4 | 0,8 | BCPR6ES | 2330 | 12 | LPG 3 | | 1498 |
| Y10 Fire/Fire LX/Fire 4WD | 1.0 | 37 | 09.86 - 12.88 | 156A3.. | 4 | 0,8 | BCPR6ES | 2330 | 12 | LPG 3 | | 1498 |
| Y10 i.e Igloo | 1.1 | 37 | 03.94 - 10.96 | 156C046 | 4 | 0,8 | BCPR6ES | 2330 | 12 | LPG 3 | | 1498 |
| Y10 i.e Junior | 1.1 | 37 | 03.94 - 10.96 | 156C046 | 4 | 0,8 | BCPR6ES | 2330 | 12 | LPG 3 | | 1498 |
| Y10 i.e Mia | 1.1 | 37 | 01.94 - 10.96 | 156C046 | 4 | 0,8 | BCPR6ES | 2330 | 12 | LPG 3 | | 1498 |
| Y10 i.e 4WD Sestrieres | 1.1 | 37 | 03.94 - 10.96 | 156C046 | 4 | 0,8 | BCPR6ES | 2330 | 12 | LPG 3 | | 1498 |
| Y10 i.e GT/i.e GT Kat./Elite | 1.3 | 53 | 11.87 - 09.92 | 156C5.046 | 4 | 0,8 | BPR6ES | 7822 | 2 | LPG 2 | | 1497 |
| Y10 i.e Selectronic Ville | 1.1 | 37 | 03.94 - 01.95 | 156C046 | 4 | 0,8 | BCPR6ES | 2330 | 12 | LPG 3 | | 1498 |
| Y10 i.e. | 1.1 | 40 | 03.95 - | | 4 | 0,8 | BCPR6ES | 2330 | 12 | LPG 3 | | 1498 |
| Y10 Touring | 1.05 | 38 | 03.85 - 02.89 | 156A0.. | 4 | 0,8 | BPR6ES | 7822 | 2 | LPG 2 | | 1497 |
| Y10 Turbo | 1.05 | 63 | 03.85 - 02.89 | 156A1.. | 4 | 0,6 | BR8ES | 5422 | | BR9EIX | | 3981 |

AVIA

| | | | | | | | | | | | | |
|---------|--|--|---------|--|---|---|--------|------|--|--|--|--|
| A21.1 D | | | 10.90 - | | 4 | █ | Y-208T | 1250 | | | | |
|---------|--|--|---------|--|---|---|--------|------|--|--|--|--|

AZLK (MOSKWITCZ)

| | | | | | | | | | | | | |
|----------|-----|----|---------------|---------|---|-----|--------|------|---|-------|--|------|
| Aleko | 1.8 | 70 | 12.86 - 12.00 | | 4 | 0,8 | BPR6ES | 7822 | 2 | LPG 2 | | 1497 |
| Aleko | 2.0 | 83 | 01.86 - 12.00 | REN-F3R | 4 | 0,9 | BPR5ES | 7422 | 6 | LPG 2 | | 1497 |
| Ish 2126 | 1.5 | | 09.87 - | | 4 | 0,7 | BP6ES | 7811 | 4 | LPG 2 | | 1497 |

BEDFORD

| | | | | | | | | | | | | |
|------------------|-----|----|---------------|--------------|---|-----|--------|------|---|-----------|--|------|
| Astra Max D | 1.6 | | 02.85 - | 16D OHC | 4 | █ | Y-924J | 7906 | | D-POWER 1 | | 7906 |
| Astra Van D | 1.6 | | 03.82 - | 16D OHC | 4 | █ | Y-924J | 7906 | | D-POWER 1 | | 7906 |
| Brava Pickup 4x4 | 2.2 | | 12.98 - | | | █ | Y-306R | 6244 | | | | |
| CF D | 2.3 | | 81 - | | 4 | █ | Y-924J | 7906 | | D-POWER 1 | | 7906 |
| CF D Van | 2.3 | | 09.80 - | Opel 23D OHC | 6 | █ | Y-208T | 1250 | | | | |
| CF2 Van | 2.0 | 57 | 08.84 - 07.87 | | 4 | 0,7 | BPR6HS | 7022 | 3 | BPR6HIX | | 4085 |



l kW



Cyl.

Order-
No. No.LPG/CNG
D-PowerOrder-
No.**BEDFORD**

| | | | | | | | | | | | |
|------------|-----|----|---------------|------|---|-----|---------|------|---|---------|------|
| HA | 1.3 | | 81 - | | 4 | 0,7 | BP6ES | 7811 | 4 | LPG 2 | 1497 |
| KB26/41 | 1.6 | | 01.84 - 01.88 | | 4 | 0,8 | BPR6ES | 7822 | 2 | BPR6EIX | 6637 |
| Midi | 1.8 | 55 | 02.85 - 05.90 | 4ZB1 | 4 | 0,8 | BPR6ES | 7822 | 2 | BPR6EIX | 6637 |
| Midi | 2.0 | 60 | 03.88 - 05.90 | | 4 | 0,8 | BPR6ES | 7822 | 2 | BPR6EIX | 6637 |
| Midi 2.0TD | 2.0 | 50 | 03.88 - 05.90 | | 4 | █ | Y-307R | 5837 | | | |
| Midi 2.0TD | 2.0 | | 03.88 - 05.90 | | 4 | █ | Y-711RS | 4444 | | | |
| Midi 2.2D | 2.2 | 44 | 03.88 - 05.90 | | 4 | █ | Y-307R | 5837 | | | |
| Midi 2.2D | 2.2 | | 03.88 - 05.90 | | 4 | █ | Y-711RS | 4444 | | | |
| Rascal | 1.0 | 32 | 02.86 - 05.90 | | 4 | 0,9 | BPR5ES | 7422 | 6 | LPG 2 | 1497 |

BENTLEY

| | | | | | | | | | | | |
|-------------------------------|-----|-----|---------------|-------------|----|-----|------------|------|----|---------|------|
| Arnage | 4.4 | 210 | 04.98 - 08.98 | BMW M62B44 | 8 | | BKR6EK | 2288 | 20 | LPG 1 | 1496 |
| Arnage | 4.4 | 210 | 08.98 - | BMW M62B44 | 8 | | BKR6EQUP | 3199 | 30 | LPG 1 | 1496 |
| Arnage | 4.4 | | 09.99 - 01 | BMW | 8 | | BKR6EQUP | 3199 | 30 | LPG 1 | 1496 |
| Arnage Green Label V8 Biturbo | 4.4 | 260 | 08.99 - 12.01 | | 8 | | BKR6EQUP | 3199 | 30 | LPG 1 | 1496 |
| Arnage Red Label V8 6.8 turbo | 6.8 | | 09.99 - | RR | 8 | | BKR5EVX | 2546 | | BKR5EIX | 6341 |
| Arnage Le Mans | 6.8 | | 03.01 - | RR | 8 | 0,9 | BKR4EVX | 4870 | | | |
| Azure | 6.7 | | | | 8 | 0,9 | BKR4EVX | 4870 | | | |
| Azure | 6.8 | | 03.95 - | | 8 | | BKR5EVX | 2546 | | BKR5EIX | 6341 |
| Azure Mulliner | 6.8 | | 03.99 - | | 8 | | BKR5EVX | 2546 | | BKR5EIX | 6341 |
| Brooklands | 6.8 | | 09.92 - 09.99 | | 8 | | BKR5EVX | 2546 | | BKR5EIX | 6341 |
| Continental | 6.8 | | 89 - | L4101 Cat. | 8 | 1,0 | BPR4EVX | 3436 | | | |
| Continental / Mulliner | 6.8 | | 02.97 - | | 8 | | BKR5EVX | 2546 | | BKR5EIX | 6341 |
| Continental Flying Spur | 6.0 | | 05 - | | 12 | 0,8 | PFR6Q | 6458 | 37 | LPG 1 | 1496 |
| Continental GT | 6.0 | | 03 - | | 12 | 0,8 | PFR6Q | 6458 | 37 | LPG 1 | 1496 |
| Continental R | 6.8 | | 12.91 - | | 8 | | BKR5EVX | 2546 | | BKR5EIX | 6341 |
| Continental R | 6.8 | | 03.92 - | L4101T Cat. | 8 | 1,0 | BPR4EVX | 3436 | | | |
| Continental R Le Mans | 6.8 | | 03.01 - | | 8 | | BKR5EVX | 2546 | | BKR5EIX | 6341 |
| Continental R Mulliner | 6.8 | | 03.99 - | | 8 | | BKR5EVX | 2546 | | BKR5EIX | 6341 |
| Continental SC / Mulliner | 6.8 | | 03.99 - 09.00 | | 8 | | BKR5EVX | 2546 | | BKR5EIX | 6341 |
| Corniche 71—>02 | 6.8 | | 01.89 - 06.93 | | 8 | 0,9 | BPR4EVX | 3436 | | | |
| Corniche 71—>02 | 6.8 | | 03.87 - 12.88 | | 8 | 0,7 | BPR5EV | 4728 | | BPR5EIX | 6597 |
| Corniche 71—>02 | 6.8 | | 07.93 - 08.95 | | 8 | 0,9 | BKR4EVX | 4870 | | | |
| Corniche 71—>02 | 6.8 | | 09.95 - | | 8 | | BKR5EVX | 2546 | | BKR5EIX | 6341 |
| Eight | 6.8 | | 89 - | L4101 Cat. | 8 | 1,0 | BPR4EVX | 3436 | | | |
| Mulsanne / S / Eight | 6.8 | | 01.89 - 06.93 | | 8 | 0,9 | BPR4EVX | 3436 | | | |
| Mulsanne / S / Eight | 6.8 | | 07.93 - | | 8 | 0,9 | BKR4EVX | 4870 | | | |
| Mulsanne / S / Eight | 6.8 | | 10.80 - 11.86 | | 8 | 0,9 | BPR5ES | 7422 | 6 | LPG 2 | 1497 |
| Mulsanne / S / Eight | 6.8 | | 12.86 - 12.88 | | 8 | 0,7 | BPR5EV | 4728 | | BPR5EIX | 6597 |
| Mulsanne TURBO —>85 | 6.8 | | 01.82 - 09.85 | | 8 | 0,9 | BPR5ES | 7422 | 6 | LPG 2 | 1497 |
| Mulsanne S | 6.8 | | 89 - | L4101 Cat. | 8 | 1,0 | BPR4EVX | 3436 | | | |
| Tous types | | | 87 - 89 | | | 1,1 | BPR5EIX-11 | 2115 | | LPG 2 | 1497 |
| Turbo R 85—>96 | 6.8 | | 01.87 - 12.88 | | 8 | 0,7 | BPR5EV | 4728 | | BPR5EIX | 6597 |
| Turbo R 85—>96 | 6.8 | | 01.89 - 09.96 | | 8 | | BKR5EVX | 2546 | | BKR5EIX | 6341 |
| Turbo R 85—>96 | 6.8 | | 03.85 - 09.86 | | 8 | 0,9 | BPR5ES | 7422 | 6 | LPG 2 | 1497 |
| Turbo R | 6.8 | | 89 - | L4101T Cat. | 8 | 1,0 | BPR4EVX | 3436 | | | |

BERTONE

| | | | | | | | | | | | |
|----------------------|-----|----|---------|---------|---|-----|--------|------|----|-------|------|
| Freeclimber 1.6i | 1.6 | 74 | 02.92 - | M40 B16 | 4 | | BKR6EK | 2288 | 20 | LPG 1 | 1496 |
| Freeclimber 2.0i 4x4 | 2.0 | 95 | 01.91 - | M20 B20 | 6 | 0,8 | ZGR5A | 5839 | 15 | | |
| Freeclimber 2.7i 4x4 | 2.7 | 95 | 01.91 - | M20 B27 | 6 | 0,8 | ZGR5A | 5839 | 15 | | |



ℓ kW

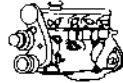

Cyl.

Order-
No.VLINE
No.LPG/CNG
D-PowerOrder-
No.**BMW**

| | | | | | | | | | | | | |
|----------------|-------|-----|-----|--------------|------------|---|---|------------|-------|----|------------|-------|
| 116i | E81 | 1.6 | 85 | 08.07 - | N45 B16 | 4 | | BKR6EQU | 6002 | | LPG 1 | 1496 |
| 116i | E81 | 1.6 | 90 | 08.07 - | N43 B16 | 4 | | ZKBR7A-HTU | 91785 | | ZKBR7A-HTU | 91785 |
| 116i | E87 | 1.6 | 85 | 09.04 - | N45 B16 | 4 | | BKR6EQU | 6002 | | LPG 1 | 1496 |
| 116i | E87 | 1.6 | 90 | 08.07 - | N43 B16 | 4 | | ZKBR7A-HTU | 91785 | | ZKBR7A-HTU | 91785 |
| 118 d | E87 | 2.0 | 90 | 09.04 - | M47 N204D4 | 4 | ▣ | Y-547AS | 5968 | | D-POWER 47 | 5968 |
| 118 i | E81 | 2.0 | 95 | 04.07 - | N46 B20 | 4 | | IZFR6H11 | 4294 | | IZFR6H11 | 4294 |
| 118 i | E81 | 2.0 | 105 | 05.07 - | N43 B20 | 4 | | ZKBR7A-HTU | 91785 | | ZKBR7A-HTU | 91785 |
| 118 i | E87 | 2.0 | 95 | 09.04 - | N46 B20 | 4 | | IZFR6H11 | 4294 | | IZFR6H11 | 4294 |
| 118 i | E87 | 2.0 | 105 | 05.07 - | N43 B20 | 4 | | ZKBR7A-HTU | 91785 | | ZKBR7A-HTU | 91785 |
| 118 i Cabrio | E88 | 2.0 | 105 | 04.08 - | N43 B20 | 4 | | ZKBR7A-HTU | 91785 | | ZKBR7A-HTU | 91785 |
| 120 d | E87 | 2.0 | 120 | 09.04 - | M47 N204D4 | 4 | ▣ | Y-547AS | 5968 | | D-POWER 47 | 5968 |
| 120 i | E81 | 2.0 | 125 | 03.07 - | N43 B20 | 4 | | ZKBR7A-HTU | 91785 | | ZKBR7A-HTU | 91785 |
| 120 i | E87 | 2.0 | 110 | 09.04 - | N46 B20 | 4 | | IZFR6H11 | 4294 | | IZFR6H11 | 4294 |
| 120 i | E87 | 2.0 | 125 | 12.06 - | N43 B20 | 4 | | ZKBR7A-HTU | 91785 | | ZKBR7A-HTU | 91785 |
| 120 i Cabrio | E88 | 2.0 | 125 | 04.08 - | N43 B20 | 4 | | ZKBR7A-HTU | 91785 | | ZKBR7A-HTU | 91785 |
| 125 i Cabrio | E88 | 3.0 | 160 | 04.08 - | N52 B30 | 4 | | PLZFR6A11S | 5987 | | | |
| 125 i Coupè | E82 | 3.0 | 160 | 09.07 - | N52 B30 | 6 | | PLZFR6A11S | 5987 | | | |
| 130 i | E81 | 3.0 | 195 | 09.06 - | N52 B30 | 6 | | ILZFR6D11 | 1208 | | ILZFR6D11 | 1208 |
| 130 i | E87 | 3.0 | 195 | 09.05 - | N52 B30 | 6 | | ILZFR6D11 | 1208 | | ILZFR6D11 | 1208 |
| 315 | E21 | 1.6 | 55 | 03.81 -03.84 | M10 B16 | 4 | | BP5ES | 6511 | 8 | LPG 2 | 1497 |
| 316 | E21 | 1.8 | 66 | 09.80 -08.87 | M10 B18 | 4 | | BP5ES | 6511 | 8 | LPG 2 | 1497 |
| 316 Ci Coupe | E46/2 | 1.6 | 75 | 04.99 -02.02 | M43 B16 | 4 | | BKR6EQU | 3199 | 30 | LPG 1 | 1496 |
| 316 Ci Coupe | E46/2 | 1.8 | 85 | 03.02 -02.04 | N40 B18 | 4 | | BKR6EQU | 3199 | 30 | LPG 1 | 1496 |
| 316 Ci Coupe | E46/2 | 1.8 | 85 | 03.04 -05.06 | N45 B18 | 4 | | IZFR6H11 | 4294 | | IZFR6H11 | 4294 |
| 316 g Compact | E36/5 | 1.6 | 65 | 02.96 -07.00 | M43 B16 | 4 | | BKR6EK | 2288 | 20 | LPG 1 | 1496 |
| 316 i | E30 | 1.6 | 73 | 09.88 -09.94 | M40 B16 | 4 | | BKR6EK | 2288 | 20 | LPG 1 | 1496 |
| 316 i | E30 | 1.8 | 75 | 09.87 -08.88 | M10 B18 | 4 | | BP5ES | 6511 | 8 | LPG 2 | 1497 |
| 316 i | E36 | 1.6 | 73 | 05.91 -08.93 | M40 B16 | 4 | | BKR6EK | 2288 | 20 | LPG 1 | 1496 |
| 316 i | E36 | 1.6 | 75 | 08.93 -05.99 | M43 B16 | 4 | | BKR6EK | 2288 | 20 | LPG 1 | 1496 |
| 316 i | E46/4 | 1.6 | 85 | 09.03 -01.05 | N45 B16 | 4 | | IZFR6H11 | 4294 | | IZFR6H11 | 4294 |
| 316 i | E46/4 | 1.8 | 85 | 10.01 -02.04 | N42 B18 | 4 | | BKR6EQU | 3199 | 30 | LPG 1 | 1496 |
| 316 i | E46/4 | 1.8 | 85 | 09.03 -01.05 | N46 B18 | 4 | | IZFR6H11 | 4294 | | IZFR6H11 | 4294 |
| 316 i | E46/4 | 1.9 | 77 | 01.99 -09.01 | M43 B19 | 4 | | BKR6EQU | 3199 | 30 | LPG 1 | 1496 |
| 316 i Compact | E36/5 | 1.6 | 75 | 04.94 -12.98 | M43 B16 | 4 | | BKR6EK | 2288 | 20 | LPG 1 | 1496 |
| 316 i Compact | E36/5 | 1.9 | 77 | 04.98 -08.00 | M43 B19 | 4 | | BKR6EK | 2288 | 20 | LPG 1 | 1496 |
| 316 i Coupe | E92 | 2.0 | 90 | 08.07 - | N43 B16 | 4 | | ZKBR7A-HTU | 91785 | | ZKBR7A-HTU | 91785 |
| 316 i Touring | E46/3 | 1.8 | 85 | 10.01 -02.04 | N42 B18 | 4 | | BKR6EQU | 3199 | 30 | LPG 1 | 1496 |
| 316 i Touring | E46/3 | 1.8 | 85 | 10.03 -07.05 | N46 B18 | 4 | | IZFR6H11 | 4294 | | IZFR6H11 | 4294 |
| 316 ti Compact | E46/5 | 1.8 | 85 | 05.01 -02.04 | N42 B18 | 4 | | BKR6EQU | 3199 | 30 | LPG 1 | 1496 |
| 316 ti Compact | E46/5 | 1.8 | 85 | 09.03 -12.04 | N46 B18 | 4 | | IZFR6H11 | 4294 | | IZFR6H11 | 4294 |
| 318 Ci Cabrio | E46/C | 2.0 | 105 | 12.00 -03.05 | N42 B20 | 4 | | BKR6EQU | 3199 | 30 | LPG 1 | 1496 |
| 318 Ci Cabrio | E46/C | 2.0 | 110 | 04.05 -08.06 | N46 B20 | 4 | | IZFR6H11 | 4294 | | IZFR6H11 | 4294 |
| 318 Ci Coupe | E46/2 | 1.9 | 87 | 09.99 -08.01 | M43 B19 | 4 | | BKR6EQU | 3199 | 30 | LPG 1 | 1496 |
| 318 Ci Coupe | E46/2 | 2.0 | 105 | 09.01 -02.04 | N42 B20 | 4 | | BKR6EQU | 3199 | 30 | LPG 1 | 1496 |
| 318 Ci Coupe | E46/2 | 2.0 | 110 | 10.03 -05.06 | N46 B20 | 4 | | IZFR6H11 | 4294 | | IZFR6H11 | 4294 |
| 318 d | E46/4 | 2.0 | 85 | 09.01 -11.03 | M47 D20 | 4 | ▣ | Y-507J | 2691 | | D-POWER 32 | 2691 |
| 318 d | E46/4 | 2.0 | 85 | 08.02 -01.05 | M47 N D20 | 4 | ▣ | Y-547AS | 5968 | | D-POWER 47 | 5968 |
| 318 d | E90 | 2.0 | 90 | 09.05 -09.07 | M47 N204D4 | 4 | ▣ | Y-547AS | 5968 | | D-POWER 47 | 5968 |
| 318 d Touring | E91 | 2.0 | 90 | 09.05 -09.07 | M47 N204D4 | 4 | ▣ | Y-547AS | 5968 | | D-POWER 47 | 5968 |
| 318 d Touring | E46/3 | 2.0 | 85 | 09.01 -11.03 | M47 D20 | 4 | ▣ | Y-507J | 2691 | | D-POWER 32 | 2691 |
| 318 d Touring | E46/3 | 2.0 | 85 | 08.02 -07.05 | M47 N D20 | 4 | ▣ | Y-547AS | 5968 | | D-POWER 47 | 5968 |
| 318 i | E30 | 1.8 | 75 | 12.84 -08.87 | M10 B18 | 4 | | BP5ES | 6511 | 8 | LPG 2 | 1497 |



l kW



Cyl.

Order-
No. No.LPG/CNG
D-PowerOrder-
No.**BMW**

| | | | | | | | | | | | | |
|----------------|-------|-----|-----|---------------|--------------|---|---|------------|-------|----|------------|-------|
| 318 i | E30 | 1.8 | 77 | 09.82 - 08.87 | M10 B18 | 4 | | BP5ES | 6511 | 8 | LPG 2 | 1497 |
| 318 i | E30 | 1.8 | 83 | 09.87 - 04.91 | M40 B18 | 4 | | BKR6EK | 2288 | 20 | LPG 1 | 1496 |
| 318 i | E36 | 1.8 | 83 | 10.90 - 09.93 | M40 B18 | 4 | | BKR6EK | 2288 | 20 | LPG 1 | 1496 |
| 318 i | E36 | 1.8 | 85 | 08.93 - 09.99 | M43 B18 | 4 | | BKR6EK | 2288 | 20 | LPG 1 | 1496 |
| 318 i | E46/4 | 1.9 | 87 | 04.98 - 08.01 | M43 B19 | 4 | | BKR6EQUP | 3199 | 30 | LPG 1 | 1496 |
| 318 i | E46/4 | 2.0 | 105 | 09.01 - 02.04 | N42 B20 | 4 | | BKR6EQUP | 3199 | 30 | LPG 1 | 1496 |
| 318 i | E46/4 | 2.0 | 105 | 10.03 - 02.05 | N46 B20 | 4 | | IZFR6H11 | 4294 | | IZFR6H11 | 4294 |
| 318 i | E90 | 2.0 | 95 | 09.04 - | N46 B20 | 4 | | IZFR6H11 | 4294 | | IZFR6H11 | 4294 |
| 318 i | E90 | 2.0 | 105 | 07.07 - | N43 B20 | 4 | | ZKBR7A-HTU | 91785 | | ZKBR7A-HTU | 91785 |
| 318 i Touring | E91 | 2.0 | 105 | 09.07 - | N43 B20 | 4 | | ZKBR7A-HTU | 91785 | | ZKBR7A-HTU | 91785 |
| 318 i Touring | E91 | 2.0 | 95 | 03.06 - | N46 B20 | 4 | | IZFR6H11 | 4294 | | IZFR6H11 | 4294 |
| 318 i Touring | E36/3 | 1.8 | 85 | 09.94 - 09.99 | M43 B18 | 4 | | BKR6EK | 2288 | 20 | LPG 1 | 1496 |
| 318 i Touring | E30 | 1.8 | 82 | 04.89 - 09.94 | M40 B18 | 4 | | BKR6EK | 2288 | 20 | LPG 1 | 1496 |
| 318 i Touring | E46/3 | 1.9 | 87 | 09.00 - 08.01 | M43 B19 | 4 | | BKR6EQUP | 3199 | 30 | LPG 1 | 1496 |
| 318 i Touring | E46/3 | 2.0 | 105 | 12.00 - 02.04 | N42 B20 | 4 | | BKR6EQUP | 3199 | 30 | LPG 1 | 1496 |
| 318 iS | E30 | 1.8 | 103 | 09.89 - 10.90 | M42 B18 | 4 | | BKR6EK | 2288 | 20 | LPG 1 | 1496 |
| 318 iS | E36 | 1.8 | 103 | 10.91 - 03.96 | M42 B18 | 4 | | BKR6EK | 2288 | 20 | LPG 1 | 1496 |
| 318 iS Coupe | E36 | 1.9 | 103 | 01.96 - 09.99 | M44 B19 | 4 | | BKR6EK | 2288 | 20 | LPG 1 | 1496 |
| 318 td Compact | E46/5 | 2.0 | 85 | 08.02 - 12.04 | M47 N D20 | 4 | ▣ | Y-547AS | 5968 | | D-POWER 47 | 5968 |
| 318 Tds | E36 | 1.8 | 66 | 11.94 - 02.98 | M41 D18 | 4 | ▣ | Y-924J | 7906 | | D-POWER 1 | 7906 |
| 318 ti Compact | E36/5 | 1.8 | 103 | 11.94 - 02.96 | M42 B18 | 4 | | BKR6EK | 2288 | 20 | LPG 1 | 1496 |
| 318 ti Compact | E36/5 | 1.9 | 103 | 02.95 - 12.98 | M44 B19 | 4 | | BKR6EK | 2288 | 20 | LPG 1 | 1496 |
| 318 ti Compact | E46/5 | 2.0 | 105 | 03.01 - 02.04 | N42 B20 | 4 | | BKR6EQUP | 3199 | 30 | LPG 1 | 1496 |
| 318 ti Compact | E46/5 | 2.0 | 105 | 09.03 - 12.04 | N46 B20 | 4 | | IZFR6H11 | 4294 | | IZFR6H11 | 4294 |
| 320 Cd | E46/2 | 2.0 | 110 | 03.03 - 05.06 | M47 N D20 | 4 | ▣ | Y-547AS | 5968 | | D-POWER 47 | 5968 |
| 320 Cd Cabrio | E46/C | 2.0 | 110 | 06.04 - 08.06 | M47 N D20 | 4 | ▣ | Y-547AS | 5968 | | D-POWER 47 | 5968 |
| 320 Ci Cabrio | E46/C | 2.2 | 125 | 02.00 - 08.06 | M54 B22 | 6 | | BKR6EQUP | 3199 | 30 | LPG 1 | 1496 |
| 320 Ci Coupe | E46/2 | 2.0 | 110 | 11.98 - 08.01 | M52 B20 | 6 | | BKR6EQUP | 3199 | 30 | LPG 1 | 1496 |
| 320 Ci Coupe | E46/2 | 2.2 | 125 | 01.00 - 03.03 | M54 B22 | 6 | | BKR6EQUP | 3199 | 30 | LPG 1 | 1496 |
| 320 d | E46/4 | 2.0 | 100 | 07.97 - 08.01 | M47 D20 | 4 | ▣ | Y-507J | 2691 | | D-POWER 32 | 2691 |
| 320 d | E46/4 | 2.0 | 110 | 10.00 - 01.05 | M47 N D20 | 4 | ▣ | Y-547AS | 5968 | | D-POWER 47 | 5968 |
| 320 d | E90 | 2.0 | 120 | 03.05 - 05.07 | M47 N204D4 | 4 | ▣ | Y-547AS | 5968 | | D-POWER 47 | 5968 |
| 320 d Touring | E46/3 | 2.0 | 100 | 02.99 - 08.01 | M47 D20 | 4 | ▣ | Y-507J | 2691 | | D-POWER 32 | 2691 |
| 320 d Touring | E46/3 | 2.0 | 110 | 06.99 - 07.05 | M47 N D20 | 4 | ▣ | Y-547AS | 5968 | | D-POWER 47 | 5968 |
| 320 d Touring | E91 | 2.0 | 120 | 09.05 - 11.07 | M47 N204D4 | 4 | ▣ | Y-547AS | 5968 | | D-POWER 47 | 5968 |
| 320 i | E30 | 2.0 | 90 | 12.86 - 12.90 | M20 B20 Cat. | 6 | | ZGR5A | 5839 | 15 | | |
| 320 i | E30 | 2.0 | 92 | 01.88 - 08.88 | M20 B20 | 6 | | ZGR5A | 5839 | 15 | | |
| 320 i | E30 | 2.0 | 92 | 09.82 - 12.87 | M20 B20 | 6 | | BP5ES | 6511 | 8 | LPG 2 | 1497 |
| 320 i | E36 | 2.0 | 110 | 01.90 - 07.95 | M50 B20 | 6 | | BKR6EK | 2288 | 20 | LPG 1 | 1496 |
| 320 i | E36 | 2.0 | 110 | 09.94 - 09.99 | M52 B20 | 6 | | BKR6EK | 2288 | 20 | LPG 1 | 1496 |
| 320 i | E46/4 | 2.0 | 110 | 07.97 - 07.01 | M52 B20 | 6 | | BKR6EQUP | 3199 | 30 | LPG 1 | 1496 |
| 320 i | E46/4 | 2.2 | 125 | 06.00 - 01.05 | M54 B22 | 6 | | BKR6EQUP | 3199 | 30 | LPG 1 | 1496 |
| 320 i | E90 | 2.0 | 110 | 03.05 - | N46 B20 | 4 | | IZFR6H11 | 4294 | | IZFR6H11 | 4294 |
| 320 i | E90 | 2.0 | 125 | 05.07 - | N43 B20 | 4 | | ZKBR7A-HTU | 91785 | | ZKBR7A-HTU | 91785 |
| 320 i Cabrio | E93 | 2.0 | 125 | 04.07 - | N46 B20 | 4 | | IZFR6H11 | 4294 | | IZFR6H11 | 4294 |
| 320 i Coupe | E92 | 2.0 | 115 | 10.06 - | N46 B20 | 4 | | IZFR6H11 | 4294 | | IZFR6H11 | 4294 |
| 320 i Coupe | E92 | 2.0 | 125 | 03.07 - | N43 B20 | 4 | | ZKBR7A-HTU | 91785 | | ZKBR7A-HTU | 91785 |
| 320 i Touring | E91 | 2.0 | 110 | 10.05 - | N46 B20 | 4 | | IZFR6H11 | 4294 | | IZFR6H11 | 4294 |
| 320 i Touring | E91 | 2.0 | 125 | 09.07 - | N43 B20 | 4 | | ZKBR7A-HTU | 91785 | | ZKBR7A-HTU | 91785 |
| 320 i Touring | E36/3 | 2.0 | 110 | 04.94 - 05.99 | M52 B20 | 6 | | BKR6EK | 2288 | 20 | LPG 1 | 1496 |
| 320 i Touring | E30 | 2.0 | 90 | 01.88 - 08.91 | M20 B20 | 6 | | ZGR5A | 5839 | 15 | | |
| 320 i Touring | E46/3 | 2.0 | 110 | 05.98 - 08.01 | M52 B20 | 6 | | BKR6EQUP | 3199 | 30 | LPG 1 | 1496 |



ℓ kW



Cyl.

Order-
No.VLINE
No.LPG/CNG
D-PowerOrder-
No.**BMW**

| | | | | | | | | | | | | |
|----------------|-------|-----|-----|---------------|------------|---|---|------------|-------|----|------------|-------|
| 320 i Touring | E46/3 | 2.2 | 125 | 05.01 - 07.05 | M54 B22 | 6 | | BKR6EQUIP | 3199 | 30 | LPG 1 | 1496 |
| 320 td Compact | E46/5 | 2.0 | 110 | 05.00 - 12.04 | M47 N D20 | 4 | ▣ | Y-547AS | 5968 | | D-POWER 47 | 5968 |
| 323 Ci Cabrio | E46/C | 2.5 | 125 | 11.98 - 09.00 | M52 B25 | 6 | | BKR6EQUIP | 3199 | 30 | LPG 1 | 1496 |
| 323 Ci Coupe | E46/2 | 2.5 | 125 | 03.98 - 08.00 | M52 B25 | 6 | | BKR6EQUIP | 3199 | 30 | LPG 1 | 1496 |
| 323 i | E30 | 2.3 | 105 | 09.82 - 08.86 | M20 B23 | 6 | | BP5ES | 6511 | 8 | LPG 2 | 1497 |
| 323 i | E36 | 2.5 | 125 | 06.95 - 04.99 | M52 B25 | 6 | | BKR6EK | 2288 | 20 | LPG 1 | 1496 |
| 323 i | E46/4 | 2.5 | 125 | 07.97 - 10.00 | M52 B25 | 6 | | BKR6EQUIP | 3199 | 30 | LPG 1 | 1496 |
| 323 i Touring | E36/3 | 2.5 | 125 | 12.95 - 05.99 | M52 B25 | 6 | | BKR6EK | 2288 | 20 | LPG 1 | 1496 |
| 323 ti Compact | E36/5 | 2.5 | 125 | 10.97 - 12.98 | M52 B25 | 6 | | BKR6EK | 2288 | 20 | LPG 1 | 1496 |
| 324 d | E30 | 2.4 | 63 | 09.85 - 08.91 | M21 D24 | 6 | ▣ | Y-924J | 7906 | | D-POWER 1 | 7906 |
| 324 Td | E30 | 2.4 | 85 | 09.87 - 12.93 | M21 D24 | 6 | ▣ | Y-924J | 7906 | | D-POWER 1 | 7906 |
| 325 Ci Cabrio | E46/C | 2.5 | 141 | 02.00 - 08.06 | M54 B25 | 6 | | BKR6EQUIP | 3199 | 30 | LPG 1 | 1496 |
| 325 Ci Coupe | E46/2 | 2.5 | 141 | 01.00 - 05.06 | M54 B25 | 6 | | BKR6EQUIP | 3199 | 30 | LPG 1 | 1496 |
| 325 d | E90 | 3.0 | 145 | 03.06 - | M57 N2 D30 | 6 | ▣ | Y-547AS | 5968 | | D-POWER 47 | 5968 |
| 325 d Coupe | E92 | 3.0 | 145 | 03.06 - | M57 N2 D30 | 6 | ▣ | Y-547AS | 5968 | | D-POWER 47 | 5968 |
| 325 d Touring | E91 | 3.0 | 145 | 03.06 - | M57 N2 D30 | 6 | ▣ | Y-547AS | 5968 | | D-POWER 47 | 5968 |
| 325 e | E30 | 2.7 | 90 | 01.85 - 08.87 | M20 B27 | 6 | | ZGR5A | 5839 | 15 | | |
| 325 i | E90 | 2.5 | 160 | 03.05 - | N52 B25 | 6 | | ILZFR6D11 | 1208 | | ILZFR6D11 | 1208 |
| 325 i | E90 | 3.0 | 160 | 09.07 - | N53 B30 | 6 | | ZKBR7A-HTU | 91785 | | ZKBR7A-HTU | 91785 |
| 325 i | E30 | 2.5 | 125 | 12.86 - 12.90 | M20 B25 | 6 | | ZGR5A | 5839 | 15 | | |
| 325 i | E30 | 2.5 | 126 | 09.85 - 12.86 | M20 B25 | 6 | | BPR6ES | 7822 | 2 | LPG 2 | 1497 |
| 325 i | E36 | 2.5 | 141 | 12.89 - 12.94 | M50 B25 | 6 | | BKR6EK | 2288 | 20 | LPG 1 | 1496 |
| 325 i | E46/4 | 2.5 | 141 | 01.00 - 01.05 | M54 B25 | 6 | | BKR6EQUIP | 3199 | 30 | LPG 1 | 1496 |
| 325 i Cabrio | E93 | 2.5 | 160 | 04.07 - | N52 B25 | 6 | | ILZFR6D11 | 1208 | | ILZFR6D11 | 1208 |
| 325 i Cabrio | E93 | 3.0 | 160 | 09.07 - | N53 B30 | 6 | | ZKBR7A-HTU | 91785 | | ZKBR7A-HTU | 91785 |
| 325 i Coupe | E92 | 2.5 | 160 | 09.06 - | N52 B25 | 6 | | ILZFR6D11 | 1208 | | ILZFR6D11 | 1208 |
| 325 i Coupe | E92 | 3.0 | 160 | 09.07 - | N53 B30 | 6 | | ZKBR7A-HTU | 91785 | | ZKBR7A-HTU | 91785 |
| 325 i Touring | E91 | 2.5 | 160 | 09.05 - | N52 B25 | 6 | | ILZFR6D11 | 1208 | | ILZFR6D11 | 1208 |
| 325 i Touring | E91 | 3.0 | 160 | 09.07 - | N53 B30 | 6 | | ZKBR7A-HTU | 91785 | | ZKBR7A-HTU | 91785 |
| 325 i Touring | E30 | 2.5 | 125 | 07.87 - 91 | M20 B25 | 6 | | ZGR5A | 5839 | 15 | | |
| 325 i Touring | E46/3 | 2.5 | 141 | 02.00 - 07.05 | M54 B25 | 6 | | BKR6EQUIP | 3199 | 30 | LPG 1 | 1496 |
| 325 iX | E30 | 2.5 | 125 | 12.86 - 01.91 | M20 B25 | 6 | | ZGR5A | 5839 | 15 | | |
| 325 iX | E30 | 2.5 | 126 | 03.86 - 12.86 | M20 B25 | 6 | | BPR6ES | 7822 | 2 | LPG 2 | 1497 |
| 325 iX Touring | E30 | 2.5 | 125 | 06.88 - 91 | M20 B25 | 6 | | ZGR5A | 5839 | 15 | | |
| 325 Td | E36 | 2.5 | 85 | 01.91 - 02.98 | M51 D25 | 6 | ▣ | Y-924J | 7906 | | D-POWER 1 | 7906 |
| 325 Tds | E36 | 2.5 | 105 | 06.93 - 05.99 | M51 D25 | 6 | ▣ | Y-924J | 7906 | | D-POWER 1 | 7906 |
| 325 ti Compact | E46/5 | 2.5 | 141 | 03.00 - 12.04 | M54 B25 | 6 | | BKR6EQUIP | 3199 | 30 | LPG 1 | 1496 |
| 325 Xi | E46/4 | 2.5 | 141 | 01.00 - 12.04 | M54 B25 | 6 | | BKR6EQUIP | 3199 | 30 | LPG 1 | 1496 |
| 325 Xi Touring | E46/3 | 2.5 | 141 | 02.00 - 05.05 | M54 B25 | 6 | | BKR6EQUIP | 3199 | 30 | LPG 1 | 1496 |
| 328 Ci Coupe | E46/2 | 2.8 | 142 | 03.98 - 06.00 | M52 B28 | 6 | | BKR6EQUIP | 3199 | 30 | LPG 1 | 1496 |
| 328 i | E36 | 2.8 | 142 | 01.95 - 09.99 | M52 B28 | 6 | | BKR6EK | 2288 | 20 | LPG 1 | 1496 |
| 328 i | E46/4 | 2.8 | 142 | 04.97 - 05.00 | M52 B28 | 6 | | BKR6EQUIP | 3199 | 30 | LPG 1 | 1496 |
| 328 i Touring | E36/3 | 2.8 | 142 | 05.95 - 05.99 | M52 B28 | 6 | | BKR6EK | 2288 | 20 | LPG 1 | 1496 |
| 328 i Touring | E46/3 | 2.8 | 142 | 05.98 - 06.00 | M52 B28 | 6 | | BKR6EQUIP | 3199 | 30 | LPG 1 | 1496 |
| 330 Cd | E92 | 3.0 | 170 | 09.06 - | M57 N2 D30 | 6 | ▣ | Y-547AS | 5968 | | D-POWER 47 | 5968 |
| 330 Cd Cabrio | E46/C | 3.0 | 150 | 11.04 - 08.06 | M57 N D30 | 6 | ▣ | Y-547AS | 5968 | | D-POWER 47 | 5968 |
| 330 Cd Coupe | E46/2 | 3.0 | 150 | 08.02 - 05.06 | M57 N D30 | 6 | ▣ | Y-547AS | 5968 | | D-POWER 47 | 5968 |
| 330 Ci Cabrio | E46/C | 3.0 | 170 | 12.99 - 08.06 | M54 B30 | 6 | | BKR6EQUIP | 3199 | 30 | LPG 1 | 1496 |
| 330 Ci Coupe | E46/2 | 3.0 | 170 | 09.99 - 05.06 | M54 B30 | 6 | | BKR6EQUIP | 3199 | 30 | LPG 1 | 1496 |
| 330 d | E46/4 | 3.0 | 135 | 09.00 - 11.03 | M57 D30 | 6 | ▣ | Y-507J | 2691 | | D-POWER 32 | 2691 |
| 330 d | E46/4 | 3.0 | 150 | 03.03 - 02.05 | M57 N D30 | 6 | ▣ | Y-547AS | 5968 | | D-POWER 47 | 5968 |
| 330 d | E90 | 3.0 | 170 | 01.06 - | M57 N2 D30 | 6 | ▣ | Y-547AS | 5968 | | D-POWER 47 | 5968 |



ℓ kW



Cyl.

Order-
No. No.LPG/CNG
D-PowerOrder-
No.**BMW**

| | | | | | | | | | | | |
|----------------|-------|-----|-----|---------------|--------------|---|------------|-------|----|------------|-------|
| 330 d Cabrio | E93 | 3.0 | 170 | 04.07 - | M57 N2 D30 | 6 | Y-547AS | 5968 | | D-POWER 47 | 5968 |
| 330 d Touring | E46/3 | 3.0 | 135 | 06.98 - 03.03 | M57 D30 | 6 | Y-507J | 2691 | | D-POWER 32 | 2691 |
| 330 d Touring | E46/3 | 3.0 | 150 | 09.02 - 07.05 | M57 N D30 | 6 | Y-547AS | 5968 | | D-POWER 47 | 5968 |
| 330 d Touring | E91 | 3.0 | 170 | 09.05 - | M57 N2 D30 | 6 | Y-547AS | 5968 | | D-POWER 47 | 5968 |
| 330 i | E46/4 | 3.0 | 170 | 09.99 - 01.05 | M54 B30 | 6 | BKR6EQUP | 3199 | 30 | LPG 1 | 1496 |
| 330 i | E90 | 3.0 | 190 | 03.05 - | N52 B30 | 6 | ILZFR6D11 | 1208 | | ILZFR6D11 | 1208 |
| 330 i | E90 | 3.0 | 200 | 07.07 - | N53 B30 | 6 | ZKBR7A-HTU | 91785 | | ZKBR7A-HTU | 91785 |
| 330 i Cabrio | E93 | 3.0 | 200 | 04.07 - | N52 B30 | 6 | ILZFR6D11 | 1208 | | ILZFR6D11 | 1208 |
| 330 i Cabrio | E93 | 3.0 | 200 | 09.07 - | N53 B30 | 6 | ZKBR7A-HTU | 91785 | | ZKBR7A-HTU | 91785 |
| 330 i Coupe | E92 | 3.0 | 200 | 09.06 - | N52 B30 | 6 | ILZFR6D11 | 1208 | | ILZFR6D11 | 1208 |
| 330 i Coupe | E92 | 3.0 | 200 | 09.07 - | N53 B30 | 6 | ZKBR7A-HTU | 91785 | | ZKBR7A-HTU | 91785 |
| 330 i Touring | E46/3 | 3.0 | 170 | 09.99 - 07.05 | M54 B30 | 6 | BKR6EQUP | 3199 | 30 | LPG 1 | 1496 |
| 330 i Touring | E91 | 3.0 | 190 | 09.05 - | N52 B30 | 6 | ILZFR6D11 | 1208 | | ILZFR6D11 | 1208 |
| 330 i Touring | E91 | 3.0 | 200 | 09.07 - | N53 B30 | 6 | ZKBR7A-HTU | 91785 | | ZKBR7A-HTU | 91785 |
| 330 Xd | E46/4 | 3.0 | 135 | 01.00 - 02.03 | M57 D30 | 6 | Y-507J | 2691 | | D-POWER 32 | 2691 |
| 330 Xd | E46/4 | 3.0 | 150 | 09.02 - 12.04 | M57 N D30 | 6 | Y-547AS | 5968 | | D-POWER 47 | 5968 |
| 330 Xd Touring | E46/3 | 3.0 | 135 | 01.00 - 03.03 | M57 D30 | 6 | Y-507J | 2691 | | D-POWER 32 | 2691 |
| 330 Xd Touring | E46/3 | 3.0 | 150 | 08.02 - 05.05 | M57 N D30 | 6 | Y-547AS | 5968 | | D-POWER 47 | 5968 |
| 330 Xi | E46/4 | 3.0 | 170 | 09.99 - 12.04 | M54 B30 | 6 | BKR6EQUP | 3199 | 30 | LPG 1 | 1496 |
| 330 Xi Touring | E46/3 | 3.0 | 170 | 09.99 - 05.05 | M54 B30 | 6 | BKR6EQUP | 3199 | 30 | LPG 1 | 1496 |
| 335 d | E90 | 3.0 | 210 | 09.06 - | M57 N2 D30 | 6 | Y-547AS | 5968 | | D-POWER 47 | 5968 |
| 335 d Coupe | E92 | 3.0 | 210 | 09.06 - | M57 N2 D30 | 6 | Y-547AS | 5968 | | D-POWER 47 | 5968 |
| 335 d Touring | E91 | 3.0 | 210 | 09.06 - | M57 N2 D30 | 6 | Y-547AS | 5968 | | D-POWER 47 | 5968 |
| 518 g Touring | E34/2 | 1.8 | 75 | 11.95 - 06.96 | M43 B18 | 4 | BKR6EK | 2288 | 20 | LPG 1 | 1496 |
| 518 i | E28 | 1.8 | 77 | 09.84 - 12.87 | M10 B18 | 4 | BP5ES | 6511 | 8 | LPG 2 | 1497 |
| 518 i | E34 | 1.8 | 83 | 09.89 - 04.94 | M40 B18 | 4 | BKR6EK | 2288 | 20 | LPG 1 | 1496 |
| 518 i | E34 | 1.8 | 85 | 05.94 - 06.96 | M43 B18 | 4 | BKR6EK | 2288 | 20 | LPG 1 | 1496 |
| 520 d | E39 | 2.0 | 100 | 09.99 - 08.03 | M47 D20 | 4 | Y-507J | 2691 | | D-POWER 32 | 2691 |
| 520 d | E60 | 2.0 | 120 | 02.05 - 09.07 | M47 N204D4 | 4 | Y-547AS | 5968 | | D-POWER 47 | 5968 |
| 520 d Touring | E61 | 2.0 | 120 | 11.05 - | M47 N204D4 | 4 | Y-547AS | 5968 | | D-POWER 47 | 5968 |
| 520 d Touring | E39/2 | 2.0 | 100 | 09.99 - 08.03 | M47 D20 | 4 | Y-507J | 2691 | | D-POWER 32 | 2691 |
| 520 i | E28 | 2.0 | 90 | 12.86 - 12.87 | M20 B20 Cat. | 6 | ZGR5A | 5839 | 15 | | |
| 520 i | E28 | 2.0 | 92 | 06.81 - 08.82 | M20 B20 | 6 | BP5ES | 6511 | 8 | LPG 2 | 1497 |
| 520 i | E28 | 2.0 | 92 | 09.82 - 12.87 | M20 B20 | 6 | BP5ES | 6511 | 8 | LPG 2 | 1497 |
| 520 i | E34 | 2.0 | 95 | 01.88 - 08.91 | M20 B20 | 6 | ZGR5A | 5839 | 15 | | |
| 520 i | E34 | 2.0 | 110 | 03.89 - 06.96 | M50 B20 | 6 | BKR6EK | 2288 | 20 | LPG 1 | 1496 |
| 520 i | E39 | 2.0 | 110 | 01.96 - 08.98 | M52 B20 | 6 | BKR6EK | 2288 | 20 | LPG 1 | 1496 |
| 520 i | E39 | 2.0 | 110 | 09.98 - 06.03 | M52 B20 | 6 | BKR6EQUP | 3199 | 30 | LPG 1 | 1496 |
| 520 i | E39 | 2.2 | 125 | 08.00 - 09.03 | M54 B22 | 6 | BKR6EQUP | 3199 | 30 | LPG 1 | 1496 |
| 520 i | E39 | 2.2 | 125 | 08.00 - 06.03 | M54 B22 | 6 | BKR6EQUP | 3199 | 30 | LPG 1 | 1496 |
| 520 i | E60 | 2.0 | 125 | 05.07 - | N43 B20 | 4 | ZKBR7A-HTU | 91785 | | ZKBR7A-HTU | 91785 |
| 520 i | E60 | 2.2 | 125 | 02.02 - 02.05 | M54 B22 | 6 | BKR6EQUP | 3199 | 30 | LPG 1 | 1496 |
| 520 i Touring | E39/2 | 2.0 | 110 | 03.97 - 08.98 | M52 B20 | 6 | BKR6EK | 2288 | 20 | LPG 1 | 1496 |
| 520 i Touring | E39/2 | 2.0 | 110 | 09.98 - 07.01 | M52 B20 | 6 | BKR6EQUP | 3199 | 30 | LPG 1 | 1496 |
| 520 i Touring | E39/2 | 2.2 | 125 | 04.00 - 12.03 | M54 B22 | 6 | BKR6EQUP | 3199 | 30 | LPG 1 | 1496 |
| 520 i Touring | E39/2 | 2.2 | 125 | 08.00 - 05.04 | M54 B22 | 6 | BKR6EQUP | 3199 | 30 | LPG 1 | 1496 |
| 523 i | E39 | 2.5 | 125 | 09.98 - 12.00 | M52 B25 | 6 | BKR6EQUP | 3199 | 30 | LPG 1 | 1496 |
| 523 i | E39 | 2.5 | 125 | 12.95 - 08.98 | M52 B25 | 6 | BKR6EK | 2288 | 20 | LPG 1 | 1496 |
| 523 i | E60 | 2.5 | 130 | 07.04 - 11.06 | N52 B25 | 6 | ILZFR6D11 | 1208 | | ILZFR6D11 | 1208 |
| 523 i | E60 | 2.5 | 140 | 02.07 - | N53 B25 | 6 | ZKBR7A-HTU | 91785 | | ZKBR7A-HTU | 91785 |
| 523 i | F10 | 3.0 | 150 | 03.10 - | N53 B30 | 6 | ZKBR7A-HTU | 91785 | | ZKBR7A-HTU | 91785 |
| 523 i Touring | E61 | 2.5 | 130 | 03.05 - | N52 B25 | 6 | ILZFR6D11 | 1208 | | ILZFR6D11 | 1208 |



ℓ kW

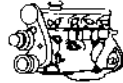

Cyl.

Order-
No.VLINE
No.LPG/CNG
D-PowerOrder-
No.**BMW**

| | | | | | | | | | | | |
|----------------|-------|-----|-----|--------------|------------|---|------------|-------|----|------------|-------|
| 523 i Touring | E61 | 2.5 | 140 | 03.07 - | N53 B25 | 6 | ZKBR7A-HTU | 91785 | | ZKBR7A-HTU | 91785 |
| 523 i Touring | F11 | 3.0 | 150 | 08.10 - | N53 B30 | 6 | ZKBR7A-HTU | 91785 | | ZKBR7A-HTU | 91785 |
| 523 i Touring | E39/2 | 2.5 | 125 | 03.97 -08.98 | M52 B25 | 6 | BKR6EK | 2288 | 20 | LPG 1 | 1496 |
| 523 i Touring | E39/2 | 2.5 | 125 | 09.98 -12.00 | M52 B25 | 6 | BKR6EQUIP | 3199 | 30 | LPG 1 | 1496 |
| 524 d | E28 | 2.4 | 63 | 09.83 -12.87 | M21 D24 | 6 | Y-924J | 7906 | | D-POWER 1 | 7906 |
| 524 Td | E28 | 2.4 | 85 | 09.83 -12.87 | M21 D24 | 6 | Y-924J | 7906 | | D-POWER 1 | 7906 |
| 524 Td | E34 | 2.4 | 85 | 03.88 -08.91 | M21 D24 | 6 | Y-924J | 7906 | | D-POWER 1 | 7906 |
| 525 d | E39 | 2.5 | 120 | 03.00 -12.03 | M57 D25 | 6 | Y-507J | 2691 | | D-POWER 32 | 2691 |
| 525 d | E60 | 2.5 | 130 | 03.04 -11.06 | M57 N D25 | 6 | Y-547AS | 5968 | | D-POWER 47 | 5968 |
| 525 d | E60 | 2.5 | 145 | 12.06 - | M57 N2 D25 | 6 | Y-547AS | 5968 | | D-POWER 47 | 5968 |
| 525 d Touring | E61 | 2.5 | 130 | 05.04 - | M57 N D25 | 6 | Y-547AS | 5968 | | D-POWER 47 | 5968 |
| 525 d Touring | E39/2 | 2.5 | 120 | 03.00 -12.03 | M57 D25 | 6 | Y-507J | 2691 | | D-POWER 32 | 2691 |
| 525 e | E28 | 2.7 | 90 | 05.83 -12.87 | M20 B27 | 6 | ZGR5A | 5839 | 15 | | |
| 525 e | E28 | 2.7 | 92 | 05.83 -12.87 | M20 B27 | 6 | BP5ES | 6511 | 8 | LPG 2 | 1497 |
| 525 i | E28 | 2.5 | 110 | 06.81 -12.87 | M20 B25 | 6 | BP5ES | 6511 | 8 | LPG 2 | 1497 |
| 525 i | E34 | 2.5 | 125 | 01.88 -08.91 | M20 B25 | 6 | ZGR5A | 5839 | 15 | | |
| 525 i | E34 | 2.5 | 141 | 01.89 -06.96 | M50 B25 | 6 | BKR6EK | 2288 | 20 | LPG 1 | 1496 |
| 525 i | E39 | 2.5 | 141 | 11.99 -11.03 | M54 B25 | 6 | BKR6EQUIP | 3199 | 30 | LPG 1 | 1496 |
| 525 i | E60 | 2.5 | 141 | 09.03 -12.04 | M54 B25 | 6 | BKR6EQUIP | 3199 | 30 | LPG 1 | 1496 |
| 525 i | E60 | 2.5 | 160 | 09.04 - | N52 B25 | 6 | ILZFR6D11 | 1208 | | ILZFR6D11 | 1208 |
| 525 i | E60 | 2.5 | 160 | 03.07 - | N53 B25 | 6 | ZKBR7A-HTU | 91785 | | ZKBR7A-HTU | 91785 |
| 525 i Touring | E61 | 2.5 | 141 | 05.04 -12.04 | M54 B25 | 6 | BKR6EQUIP | 3199 | 30 | LPG 1 | 1496 |
| 525 i Touring | E61 | 2.5 | 160 | 09.04 - | N52 B25 | 6 | ILZFR6D11 | 1208 | | ILZFR6D11 | 1208 |
| 525 i Touring | E61 | 2.5 | 160 | 03.07 - | N53 B25 | 6 | ZKBR7A-HTU | 91785 | | ZKBR7A-HTU | 91785 |
| 525 i Touring | E39/2 | 2.5 | 141 | 04.00 -12.03 | M54 B25 | 6 | BKR6EQUIP | 3199 | 30 | LPG 1 | 1496 |
| 525 iX | E34 | 2.5 | 141 | 01.92 -09.95 | M50 B25 | 6 | BKR6EK | 2288 | 20 | LPG 1 | 1496 |
| 525 iX Touring | E34/2 | 2.5 | 141 | 01.92 -09.96 | M50 B25 | 6 | BKR6EK | 2288 | 20 | LPG 1 | 1496 |
| 525 Td | E34 | 2.5 | 85 | 06.92 -06.96 | M51 D25 | 6 | Y-924J | 7906 | | D-POWER 1 | 7906 |
| 525 Tds | E34 | 2.5 | 105 | 01.90 -06.96 | M51 D25 | 6 | Y-924J | 7906 | | D-POWER 1 | 7906 |
| 525 Tds | E39 | 2.5 | 105 | 03.95 -10.00 | M51 D25 | 6 | Y-924J | 7906 | | D-POWER 1 | 7906 |
| 528 i | E28 | 2.8 | 135 | 06.81 -12.87 | M30 B28 | 6 | BP5ES | 6511 | 8 | LPG 2 | 1497 |
| 528 i | E39 | 2.8 | 142 | 09.98 -11.00 | M52 B28 | 6 | BKR6EQUIP | 3199 | 30 | LPG 1 | 1496 |
| 528 i | E39 | 2.8 | 142 | 12.95 -08.98 | M52 B28 | 6 | BKR6EK | 2288 | 20 | LPG 1 | 1496 |
| 528 i | F10 | 3.0 | 190 | 03.10 - | N53 B30 | 6 | ZKBR7A-HTU | 91785 | | ZKBR7A-HTU | 91785 |
| 528 i Touring | E39/2 | 2.8 | 142 | 03.97 -08.98 | M52 B28 | 6 | BKR6EK | 2288 | 20 | LPG 1 | 1496 |
| 528 i Touring | E39/2 | 2.8 | 142 | 09.98 -12.00 | M52 B28 | 6 | BKR6EQUIP | 3199 | 30 | LPG 1 | 1496 |
| 530 d | E39 | 3.0 | 142 | 09.98 -12.03 | M57 D30 | 6 | Y-507J | 2691 | | D-POWER 32 | 2691 |
| 530 d | E60 | 3.0 | 160 | 08.02 -10.05 | M57 N D30 | 6 | Y-547AS | 5968 | | D-POWER 47 | 5968 |
| 530 d | E60 | 3.0 | 170 | 02.05 - | M57 N2 D30 | 6 | Y-547AS | 5968 | | D-POWER 47 | 5968 |
| 530 d Touring | E61 | 3.0 | 160 | 11.02 -10.05 | M57 N D30 | 6 | Y-547AS | 5968 | | D-POWER 47 | 5968 |
| 530 d Touring | E61 | 3.0 | 173 | 02.05 - | M57 N2 D30 | 6 | Y-547AS | 5968 | | D-POWER 47 | 5968 |
| 530 d Touring | E61 | 3.0 | 180 | 02.10 - | M57 N2 D30 | 6 | Y-547AS | 5968 | | D-POWER 47 | 5968 |
| 530 d Touring | E39/2 | 3.0 | 142 | 02.99 -03.04 | M57 D30 | 6 | Y-507J | 2691 | | D-POWER 32 | 2691 |
| 530 i | E34 | 3.0 | 138 | 01.88 -08.91 | M30 B30 | 6 | ZGR5A | 5839 | 15 | | |
| 530 i | E34 | 3.0 | 155 | 04.92 -06.96 | M60 B30 | 8 | BKR6EK | 2288 | 20 | LPG 1 | 1496 |
| 530 i | E39 | 3.0 | 170 | 04.00 -06.03 | M54 B30 | 6 | BKR6EQUIP | 3199 | 30 | LPG 1 | 1496 |
| 530 i | E60 | 3.0 | 170 | 07.03 -12.04 | M54 B30 | 6 | BKR6EQUIP | 3199 | 30 | LPG 1 | 1496 |
| 530 i | E60 | 3.0 | 190 | 10.04 - | N52 B30 | 6 | ILZFR6D11 | 1208 | | ILZFR6D11 | 1208 |
| 530 i | E60 | 3.0 | 200 | 01.07 - | N53 B30 | 6 | ZKBR7A-HTU | 91785 | | ZKBR7A-HTU | 91785 |
| 530 i Touring | E61 | 3.0 | 190 | 10.05 - | N52 B30 | 6 | ILZFR6D11 | 1208 | | ILZFR6D11 | 1208 |
| 530 i Touring | E61 | 3.0 | 200 | 01.07 - | N53 B30 | 6 | ZKBR7A-HTU | 91785 | | ZKBR7A-HTU | 91785 |
| 530 i Touring | E39/2 | 3.0 | 170 | 11.99 -12.03 | M54 B30 | 6 | BKR6EQUIP | 3199 | 30 | LPG 1 | 1496 |



ℓ kW



Cyl.

Order-
No. No.LPG/CNG
D-PowerOrder-
No.**BMW**

| | | | | | | | | | | | | | |
|---------------|-------|-----|-----|---------------|------------|---|---|------------|-------|----|--|------------|-------|
| 530 Xd | E60 | 3.0 | 160 | 10.05 - | M57 N D30 | 6 | ▣ | Y-547AS | 5968 | | | D-POWER 47 | 5968 |
| 535 d | E60 | 3.0 | 200 | 09.04 - 02.05 | M57 N D30 | 6 | ▣ | Y-547AS | 5968 | | | D-POWER 47 | 5968 |
| 535 d | E60 | 3.0 | 210 | 09.05 - | M57 N2 D30 | 6 | ▣ | Y-547AS | 5968 | | | D-POWER 47 | 5968 |
| 535 d Touring | E61 | 3.0 | 200 | 09.04 - | M57 N D30 | 6 | ▣ | Y-547AS | 5968 | | | D-POWER 47 | 5968 |
| 535 i | E28 | 3.4 | 136 | 01.85 - 12.87 | M30 B35 | 6 | | ZGR5A | 5839 | 15 | | | |
| 535 i | E28 | 3.4 | 155 | 09.84 - 12.87 | M30 B35 | 6 | | BP5ES | 6511 | 8 | | LPG 2 | 1497 |
| 535 i | E34 | 3.5 | 155 | 01.88 - 08.92 | M30 B35 | 6 | | ZGR5A | 5839 | 15 | | | |
| 535 i | E39 | 3.5 | 180 | 06.96 - 08.98 | M62 B35 | 8 | | BKR6EK | 2288 | 20 | | LPG 1 | 1496 |
| 535 i | E39 | 3.5 | 180 | 09.98 - 09.03 | M62 B35 | 8 | | BKR6EQUP | 3199 | 30 | | LPG 1 | 1496 |
| 540 i | E60 | 4.0 | 225 | 10.05 - | N62 B40 | 8 | | IZFR6H11 | 4294 | | | IZFR6H11 | 4294 |
| 540 i | E34 | 4.0 | 210 | 03.92 - 06.96 | M60 B40 | 8 | | BKR6EK | 2288 | 20 | | LPG 1 | 1496 |
| 540 i | E39 | 4.4 | 210 | 04.96 - 08.98 | M62 B44 | 8 | | BKR6EK | 2288 | 20 | | LPG 1 | 1496 |
| 540 i | E39 | 4.4 | 210 | 09.98 - 11.03 | M62 B44 | 8 | | BKR6EQUP | 3199 | 30 | | LPG 1 | 1496 |
| 540 i Touring | E39/2 | 4.4 | 210 | 03.97 - 08.98 | M62 B44 | 8 | | BKR6EK | 2288 | 20 | | LPG 1 | 1496 |
| 540 i Touring | E39/2 | 4.4 | 210 | 09.98 - 12.03 | M62 B44 | 8 | | BKR6EQUP | 3199 | 30 | | LPG 1 | 1496 |
| 545 i | E60 | 4.4 | 245 | 09.03 - 10.05 | N62 B44 | 8 | | BKR6EQUP | 3199 | 30 | | LPG 1 | 1496 |
| 545 i Touring | E61 | 4.4 | 245 | 05.04 - 08.05 | N62 B44 | 8 | | BKR6EQUP | 3199 | 30 | | LPG 1 | 1496 |
| 550 i | E60 | 4.8 | 270 | 02.05 - | N62 B48 | 8 | | IZFR6H11 | 4294 | | | IZFR6H11 | 4294 |
| 550 i Touring | E61 | 4.8 | 270 | 02.05 - | N62 B48 | 8 | | IZFR6H11 | 4294 | | | IZFR6H11 | 4294 |
| 630 Ci | E63 | 3.0 | 190 | 02.04 - | N52 B30 | 6 | | ILZFR6D11 | 1208 | | | ILZFR6D11 | 1208 |
| 630 Ci | E63 | 3.0 | 200 | 04.06 - | N53 B30 | 6 | | ZKBR7A-HTU | 91785 | | | ZKBR7A-HTU | 91785 |
| 630 Ci Cabrio | E64 | 3.0 | 190 | 09.04 - | N52 B30 | 6 | | ILZFR6D11 | 1208 | | | ILZFR6D11 | 1208 |
| 635 Cd | E63 | 3.0 | 210 | 05.06 - | M57 N2 D30 | 6 | ▣ | Y-547AS | 5968 | | | D-POWER 47 | 5968 |
| 635 Ci | E63 | 3.6 | 200 | 09.04 - | N62 B36 | 8 | | BKR6EQUP | 3199 | 30 | | LPG 1 | 1496 |
| 635 CSi | E24 | 3.4 | 136 | 01.85 - 05.89 | M30 B35 | 6 | | ZGR5A | 5839 | 15 | | | |
| 635 CSi | E24 | 3.4 | 150 | 05.82 - 05.87 | M30 B35 | 6 | | BP5ES | 6511 | 8 | | LPG 2 | 1497 |
| 635 CSi | E24 | 3.4 | 150 | 06.87 - 08.88 | M30 B35 | 6 | | ZGR5A | 5839 | 15 | | | |
| 645 Ci | E63 | 4.4 | 245 | 09.02 - 08.05 | N62 B44 | 8 | | BKR6EQUP | 3199 | 30 | | LPG 1 | 1496 |
| 645 Ci Cabrio | E64 | 4.4 | 245 | 02.04 - 09.05 | N62 B44 | 8 | | BKR6EQUP | 3199 | 30 | | LPG 1 | 1496 |
| 650 Ci | E63 | 4.8 | 270 | 10.05 - | N62 B48 | 8 | | IZFR6H11 | 4294 | | | IZFR6H11 | 4294 |
| 650 Ci Cabrio | E64 | 4.8 | 270 | 03.05 - | N62 B48 | 8 | | IZFR6H11 | 4294 | | | IZFR6H11 | 4294 |
| 725 Tds | E38 | 2.5 | 105 | 09.95 - 11.00 | M51 D25 | 6 | ▣ | Y-924J | 7906 | | | D-POWER 1 | 7906 |
| 728 i | E38 | 2.8 | 142 | 09.95 - 08.98 | M52 B28 | 6 | | BKR6EK | 2288 | 20 | | LPG 1 | 1496 |
| 728 i | E38 | 2.8 | 142 | 09.98 - 11.01 | M52 B28 | 6 | | BKR6EQUP | 3199 | 30 | | LPG 1 | 1496 |
| 730 d | E38 | 3.0 | 142 | 09.98 - 12.01 | M57 D30 | 6 | ▣ | Y-507J | 2691 | | | D-POWER 32 | 2691 |
| 730 d | E65 | 3.0 | 150 | 11.01 - 02.05 | M57 N D30 | 6 | ▣ | Y-547AS | 5968 | | | D-POWER 47 | 5968 |
| 730 d | E65 | 3.0 | 170 | 07.04 - | M57 N2 D30 | 6 | ▣ | Y-547AS | 5968 | | | D-POWER 47 | 5968 |
| 730 i | E32 | 3.0 | 136 | 09.86 - 08.92 | M30 B30 | 6 | | ZGR5A | 5839 | 15 | | | |
| 730 i | E32 | 3.0 | 160 | 04.92 - 09.94 | M60 B30 | 8 | | BKR6EK | 2288 | 20 | | LPG 1 | 1496 |
| 730 i | E38 | 3.0 | 160 | 09.94 - 09.95 | M60 B30 | 8 | | BKR6EK | 2288 | 20 | | LPG 1 | 1496 |
| 730 i | E65 | 3.0 | 170 | 10.02 - 02.05 | M54 B30 | 6 | | BKR6EQUP | 3199 | 30 | | LPG 1 | 1496 |
| 730 i | E65 | 3.0 | 190 | 03.05 - | N52 B30 | 6 | | ILZFR6D11 | 1208 | | | ILZFR6D11 | 1208 |
| 735 i | E32 | 3.4 | 136 | 01.85 - 08.86 | M30 B35 | 6 | | ZGR5A | 5839 | 15 | | | |
| 735 i | E32 | 3.4 | 155 | 09.86 - 07.92 | M30 B35 | 6 | | ZGR5A | 5839 | 15 | | | |
| 735 i | E32 | 3.4 | 160 | 09.82 - 08.86 | M30 B35 | 6 | | BP5ES | 6511 | 8 | | LPG 2 | 1497 |
| 735 i | E38 | 3.5 | 175 | 03.96 - 08.98 | M62 B35 | 8 | | BKR6EK | 2288 | 20 | | LPG 1 | 1496 |
| 735 i | E38 | 3.5 | 175 | 09.98 - | M62 B35 | 8 | | BKR6EQUP | 3199 | 30 | | LPG 1 | 1496 |
| 735 i | E65 | 3.6 | 200 | 07.01 - 02.05 | N62 B36 | 8 | | BKR6EQUP | 3199 | 30 | | LPG 1 | 1496 |
| 740 i | E32 | 4.0 | 210 | 04.92 - 09.94 | M60 B40 | 8 | | BKR6EK | 2288 | 20 | | LPG 1 | 1496 |
| 740 i | E38 | 4.0 | 210 | 09.94 - 05.95 | M60 B40 | 8 | | BKR6EK | 2288 | 20 | | LPG 1 | 1496 |
| 740 i | E38 | 4.4 | 210 | 05.95 - 08.98 | M62 B44 | 8 | | BKR6EK | 2288 | 20 | | LPG 1 | 1496 |
| 740 i | E38 | 4.4 | 210 | 09.99 - 11.01 | M62 B44 | 8 | | BKR6EQUP | 3199 | 30 | | LPG 1 | 1496 |



ℓ kW

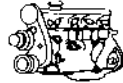

Cyl.

Order-
No.VLINE
No.LPG/CNG
D-PowerOrder-
No.**BMW**

| | | | | | | | | | | | |
|--------------------|-----|-----|-----|--------------|--------------|----|---------------|------|----|------------|------|
| 740 i | E65 | 4.0 | 225 | 01.05 - | N62 B40 | 8 | IZFR6H11 | 4294 | | IZFR6H11 | 4294 |
| 745 i | E32 | 3.2 | 185 | 04.80 -04.83 | M30 B32 | 6 | BP5ES | 6511 | 8 | LPG 2 | 1497 |
| 745 i | E32 | 3.4 | 185 | 05.83 -08.86 | M30 B34 | 6 | BP5ES | 6511 | 8 | LPG 2 | 1497 |
| 745 i | E65 | 4.4 | 245 | 07.01 -02.05 | N62 B44 | 8 | BKR6EQUP | 3199 | 30 | LPG 1 | 1496 |
| 750 i | E32 | 5.0 | 220 | 09.87 -09.94 | M70 B50 | 12 | ZFR5F | 5165 | | LPG 6 | 1565 |
| 750 i | E38 | 5.4 | 240 | 11.94 - | M73 B54 | 12 | BKR6EQUP | 3199 | 30 | LPG 1 | 1496 |
| 750 i | E65 | 4.8 | 270 | 01.05 - | N62 B48 | 8 | IZFR6H11 | 4294 | | IZFR6H11 | 4294 |
| 760 i | E65 | 6.0 | 327 | 01.03 - | N73 B60 | 12 | BKR6EQUP | 3199 | 30 | LPG 1 | 1496 |
| 840 Ci | E31 | 4.0 | 210 | 12.93 -02.96 | M60 B40 | 8 | BKR6EK | 2288 | 20 | LPG 1 | 1496 |
| 840 Ci | E31 | 4.4 | 210 | 03.96 -05.99 | M62 B44 | 8 | BKR6EK | 2288 | 20 | LPG 1 | 1496 |
| 850 Ci | E31 | 5.0 | 220 | 05.89 -10.94 | M70 B50 | 12 | ZFR5F | 5165 | | LPG 6 | 1565 |
| 850 Ci | E31 | 5.4 | 240 | 10.94 -05.99 | M73 B54 | 12 | BKR6EQUP | 3199 | 30 | LPG 1 | 1496 |
| 850 CSI | E31 | 5.6 | 280 | 02.93 -11.96 | S70 B56 | 12 | ZFR5F | 5165 | | LPG 6 | 1565 |
| M3 | E30 | 2.3 | 143 | 07.86 -12.90 | S14 B23 | 4 | only OES | | | | |
| M3 | E36 | 3.0 | 210 | 11.92 -07.95 | S50 B30 | 6 | only OES | | | | |
| M3 | E36 | 3.2 | 236 | 11.95 -10.99 | S50 B32 | 6 | PKR7A | 3641 | | PKR7A | 3641 |
| M3 | E46 | 3.2 | 252 | 07.99 -08.06 | S54 B32 | 6 | DCPR8EKP | 7415 | | | |
| M3 | E90 | 4.0 | 309 | 09.07 - | S65 B40 | 8 | LKR8AP | 4471 | | LKR8AP | 4471 |
| M3 | E92 | 4.0 | 309 | 03.07 - | S65 B40 | 8 | LKR8AP | 4471 | | LKR8AP | 4471 |
| M3 | E93 | 4.0 | 309 | 09.07 - | S65 B40 | 8 | LKR8AP | 4471 | | LKR8AP | 4471 |
| M3 CSL | E46 | 3.2 | 265 | 09.02 -12.03 | S54 B32 | 6 | DCPR8EKP | 7415 | | | |
| M3 Sport Evolution | E30 | 2.5 | 175 | 11.89 -08.91 | S14 B25 | 4 | only OES | | | | |
| M5 | E28 | 3.5 | 191 | 01.85 -12.87 | S38 B35 | 6 | only OES | | | | |
| M5 | E34 | 3.5 | 232 | 10.88 -12.92 | S38 B35 | 6 | only OES | | | | |
| M5 | E34 | 3.8 | 250 | 01.92 -07.95 | S38 B38 | 6 | only OES | | | | |
| M5 | E39 | 5.0 | 294 | 09.98 -07.03 | S62 B50 | 8 | BKR6EQUP | 3199 | 30 | LPG 1 | 1496 |
| M5 | E60 | 5.0 | 373 | 11.04 - | S85 B50 | 10 | LKR8AP | 4471 | | LKR8AP | 4471 |
| M535 i | E12 | 3.4 | 160 | 04.80 -05.81 | M30 B35 | 6 | BP6ES | 7811 | 4 | LPG 2 | 1497 |
| M535 i | E28 | 3.4 | 136 | 01.85 -12.87 | M30 B35 | 6 | ZGR5A | 5839 | 15 | | |
| M535 i | E28 | 3.4 | 155 | 09.84 -09.87 | M30 B35 | 6 | BP5ES | 6511 | 8 | LPG 2 | 1497 |
| M535 i | E28 | 3.4 | 160 | 04.80 -05.81 | M30 B35 | 6 | BP5ES | 6511 | 8 | LPG 2 | 1497 |
| M6 | E63 | 5.0 | 373 | 09.04 - | S85 B50 | 10 | LKR8AP | 4471 | | LKR8AP | 4471 |
| M6 Cabrio | E64 | 5.0 | 373 | 07.05 - | S85 B50 | 10 | LKR8AP | 4471 | | LKR8AP | 4471 |
| M635 CSI | E24 | 3.5 | 191 | 01.85 -05.89 | S38 B35 Kat. | 6 | only OES | | | | |
| X 1 Xdrive18i | E84 | 2.0 | 110 | 09.08 - | N46 B20 | 4 | IZFR6H11 | 4294 | | IZFR6H11 | 4294 |
| X 1 Xdrive25i | E84 | 3.0 | 160 | 09.08 - | N52 B30 | 6 | PLZFR6A11S | 5987 | | | |
| X 1 Xdrive28i | E84 | 3.0 | 190 | 09.08 - | N52 B30 | 6 | PLZFR6A11S | 5987 | | | |
| X 3 xDrive20d 4x4 | E83 | 2.0 | 110 | 09.04 - | M47 N D20 | 4 | Y-547AS | 5968 | | D-POWER 47 | 5968 |
| X 3 xDrive20i 4X4 | E83 | 2.0 | 110 | 09.05 - | N46 B20 | 4 | 1,1 IZFR6H11 | 4294 | | IZFR6H11 | 4294 |
| X 3 xDrive25i 4x4 | E83 | 2.5 | 141 | 01.04 - | M54 B25 | 6 | BKR6EQUP | 3199 | 30 | LPG 1 | 1496 |
| X 3 xDrive25i 4x4 | E83 | 2.5 | 160 | 08.06 - | N52 B25 | 6 | 1,1 ILZFR6D11 | 1208 | | ILZFR6D11 | 1208 |
| X 3 xDrive30d 4x4 | E83 | 3.0 | 150 | 01.03 -09.05 | M57 N D30 | 6 | Y-547AS | 5968 | | D-POWER 47 | 5968 |
| X 3 xDrive30d 4x4 | E83 | 3.0 | 160 | 10.04 - | M57 N2 D30 | 6 | Y-547AS | 5968 | | D-POWER 47 | 5968 |
| X 3 xDrive30i 4x4 | E83 | 3.0 | 170 | 01.04 - | M54 B30 | 6 | BKR6EQUP | 3199 | 30 | LPG 1 | 1496 |
| X 3 xDrive30i 4x4 | E83 | 3.0 | 200 | 06.06 - | N52 B30 | 6 | 1,1 ILZFR6D11 | 1208 | | ILZFR6D11 | 1208 |
| X 3 xDrive35d 4x4 | E83 | 3.0 | 210 | 09.06 - | M57 N2 D30 | 6 | Y-547AS | 5968 | | D-POWER 47 | 5968 |
| X 5 3.0 sd 4x4 | E70 | 3.0 | 210 | 07 - | M57 N2 D30 | 6 | Y-547AS | 5968 | | D-POWER 47 | 5968 |
| X 5 4.6 iS 4x4 | E53 | 4.6 | 255 | 01.01 -09.03 | M62 B46 | 8 | BKR6EQUP | 3199 | 30 | LPG 1 | 1496 |
| X 5 4.8 iS 4x4 | E53 | 4.8 | 265 | 11.03 -09.06 | N62 B48 | 8 | IZFR6H11 | 4294 | | IZFR6H11 | 4294 |
| X 5 4.8 iS 4x4 | E70 | 4.8 | 261 | 02.07 - | N62 B48 | 8 | IZFR6H11 | 4294 | | IZFR6H11 | 4294 |
| X 5d 4x4 | E70 | 3.0 | 173 | 07 - | M57 N2 D30 | 6 | Y-547AS | 5968 | | D-POWER 47 | 5968 |
| X 5d 4x4 | E53 | 3.0 | 142 | 08.01 -11.03 | M57 D30 | 6 | Y-507J | 2691 | | D-POWER 32 | 2691 |



ℓ kW



Cyl.

Order-
No. No.LPG/CNG
D-PowerOrder-
No.**BMW**

| | | | | | | | | | | | | | |
|--------------|-----|--------|-----|-----|---------------|-----------|---|-----|------------|------|----|------------|------|
| X 5d | 4x4 | E53 | 3.0 | 160 | 01.03 - 09.06 | M57 N D30 | 6 | ■ | Y-547AS | 5968 | | D-POWER 47 | 5968 |
| X 5i | 4x4 | E53 | 3.0 | 170 | 08.99 - 09.06 | M54 B30 | 6 | | BKR6EQUP | 3199 | 30 | LPG 1 | 1496 |
| X 5i | 4x4 | E53 | 4.4 | 210 | 10.98 - 09.03 | M62 B44 | 8 | | BKR6EQUP | 3199 | 30 | LPG 1 | 1496 |
| X 5i | 4x4 | E53 | 4.4 | 235 | 01.03 - 09.06 | N62 B44 | 8 | | BKR6EQUP | 3199 | 30 | LPG 1 | 1496 |
| X 5i 3.0 si | 4x4 | E70 | 3.0 | 200 | 02.07 - | N52 B30 | 6 | | ILZFR6D11 | 1208 | | ILZFR6D11 | 1208 |
| Z 1 | | | 2.5 | 125 | 11.88 - 06.91 | M20 B25 | 6 | 0,8 | ZGR5A | 5839 | 15 | | |
| Z 3 | | E36/7 | 1.8 | 85 | 01.98 - 02.99 | M43 B18 | 4 | | BKR6EQUP | 3199 | 30 | LPG 1 | 1496 |
| Z 3 | | E36/7 | 1.8 | 85 | 02.96 - 09.98 | M43 B18 | 4 | | BKR6EK | 2288 | 20 | LPG 1 | 1496 |
| Z 3 | | E36/7 | 1.9 | 87 | 03.99 - 06.02 | M43 B19 | 4 | | BKR6EQUP | 3199 | 30 | LPG 1 | 1496 |
| Z 3 | | E36/7 | 1.9 | 103 | 11.95 - 03.99 | M44 B19 | 4 | | BKR6EK | 2288 | 20 | LPG 1 | 1496 |
| Z 3 | | E36/7 | 2.0 | 110 | 09.98 - 12.00 | M52 B20 | 6 | | BKR6EQUP | 3199 | 30 | LPG 1 | 1496 |
| Z 3 | | E36/7 | 2.2 | 125 | 12.99 - 06.02 | M54 B22 | 6 | | BKR6EQUP | 3199 | 30 | LPG 1 | 1496 |
| Z 3 | | E36/7 | 2.8 | 142 | 01.98 - 05.00 | M52 B28 | 6 | | BKR6EQUP | 3199 | 30 | LPG 1 | 1496 |
| Z 3 | | E36/7 | 2.8 | 142 | 06.96 - 09.98 | M52 B28 | 6 | | BKR6EK | 2288 | 20 | LPG 1 | 1496 |
| Z 3 | | E36/7 | 3.0 | 170 | 09.99 - 06.02 | M54 B30 | 6 | | BKR6EQUP | 3199 | 30 | LPG 1 | 1496 |
| Z 3 Coupè | | E36/7C | 2.8 | 142 | 01.98 - 12.00 | M52 B28 | 6 | | BKR6EQUP | 3199 | 30 | LPG 1 | 1496 |
| Z 3 Coupè | | E36/7C | 3.0 | 170 | 09.99 - 06.02 | M54 B30 | 6 | | BKR6EQUP | 3199 | 30 | LPG 1 | 1496 |
| Z 3 M | | E36/7 | 3.2 | 236 | 04.96 - 06.00 | S50 B32 | 6 | | PKR7A | 3641 | | PKR7A | 3641 |
| Z 3 M | | E36/7 | 3.2 | 239 | 03.00 - 05.02 | S54 B32 | 6 | | DCPR8EKP | 7415 | | | |
| Z 3 M Coupè | | E36/7C | 3.2 | 236 | 09.97 - 07.00 | S50 B32 | 6 | | PKR7A | 3641 | | PKR7A | 3641 |
| Z 3 M Coupè | | E36/7C | 3.2 | 239 | 03.00 - 05.02 | S54 B32 | 6 | | DCPR8EKP | 7415 | | | |
| Z 4 | | E85 | 2.0 | 110 | 09.04 - | N46 B20 | 4 | | IZFR6H11 | 4294 | | IZFR6H11 | 4294 |
| Z 4 | | E85 | 2.2 | 125 | 09.03 - | M54 B22 | 6 | | BKR6EQUP | 3199 | 30 | LPG 1 | 1496 |
| Z 4 | | E85 | 2.5 | 130 | 07 - | N52 B25 | 6 | | ILZFR6D11 | 1208 | | ILZFR6D11 | 1208 |
| Z 4 | | E85 | 2.5 | 141 | 04.03 - | M54 B25 | 6 | | BKR6EQUP | 3199 | 30 | LPG 1 | 1496 |
| Z 4 | | E85 | 3.0 | 170 | 04.03 - | M54 B30 | 6 | | BKR6EQUP | 3199 | 30 | LPG 1 | 1496 |
| Z 4 23i | | E89 | 2.5 | 150 | 08 - | N52 B25 | 6 | | PLZFR6A11S | 5987 | | | |
| Z 4 30i | | E89 | 3.0 | 190 | 08 - | N52 B30 | 6 | | PLZFR6A11S | 5987 | | | |
| Z 4 M | | E85 | 3.2 | 252 | 03.06 - | S54 B32 | 6 | | DCPR8EKP | 7415 | | | |
| Z 4 M Coupè | | E86 | 3.2 | 252 | 10.05 - | S54 B32 | 6 | | DCPR8EKP | 7415 | | | |
| Z 4 si | | E85 | 3.0 | 195 | 10.05 - | N52 B30 | 6 | | ILZFR6D11 | 1208 | | ILZFR6D11 | 1208 |
| Z 4 si Coupè | | E86 | 3.0 | 195 | 10.05 - | N52 B30 | 6 | | ILZFR6D11 | 1208 | | ILZFR6D11 | 1208 |
| Z 4si | | E85 | 2.5 | 160 | 10.04 - | N52 B25 | 6 | | ILZFR6D11 | 1208 | | ILZFR6D11 | 1208 |
| Z 8 | | E52 | 5.0 | 294 | 06.00 - 07.03 | S62 B50 | 8 | | BKR6EQUP | 3199 | 30 | LPG 1 | 1496 |

BRISTOL

| | | | | | | | | | | | | | |
|----------------------|--|--|-----|-----|---------------|-----------------|---|-----|--------|------|---|-------|------|
| Beaufighter | | | 5.9 | | 01.80 - 12.89 | | 8 | 0,9 | BPR5ES | 7422 | 6 | LPG 2 | 1497 |
| Beaufighter V8 Turbo | | | 5.9 | | 01.80 - 12.89 | | 8 | 0,9 | BPR5ES | 7422 | 6 | LPG 2 | 1497 |
| Blenheim | | | 5.9 | 170 | 03.94 - | 360 V8 Chrysler | 8 | 0,9 | BPR5ES | 7422 | 6 | LPG 2 | 1497 |
| Brigand Turbo | | | 5.9 | | | | 8 | 0,9 | BPR5ES | 7422 | 6 | LPG 2 | 1497 |
| Britannia Turbo | | | 5.9 | | 10.82 - 12.89 | | 8 | 0,9 | BPR5ES | 7422 | 6 | LPG 2 | 1497 |

BUICK

| | | | | | | | | | | | | | |
|---------|--|--|-----|--|---------|----------------|---|-----|--------|------|--|----------|------|
| Century | | | 2.2 | | 93 - 94 | 4 | 4 | 1,0 | TR4 | 4392 | | LPG 5 | 1516 |
| Century | | | 2.2 | | 95 - 96 | 4 | 4 | 1,5 | TR55-1 | 6674 | | TR55-1IX | 7316 |
| Century | | | 2.5 | | 82 - 83 | 5 | 4 | 1,5 | UR45 | 2451 | | UR5IX | 7177 |
| Century | | | 2.5 | | 82 - 83 | R | 4 | 1,5 | UR45 | 2451 | | UR5IX | 7177 |
| Century | | | 2.5 | | 84 - 92 | R | 4 | 1,5 | UR55 | 6950 | | UR55IX | 7272 |
| Century | | | 2.8 | | 87 - 89 | W V6 | 6 | 1,0 | TR4 | 4392 | | LPG 5 | 1516 |
| Century | | | 2.8 | | 83 - | X 2 bbl CID173 | 6 | 1,3 | UR5 | 2139 | | UR6IX | 7348 |
| Century | | | 2.8 | | 83 - 86 | X V6 | 6 | 1,3 | UR5 | 2139 | | UR6IX | 7348 |
| Century | | | 3.0 | | 82 - | E 2 bbl CID181 | 6 | 2,0 | UR40 | 4386 | | | |



ℓ kW

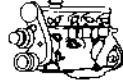

Cyl.

Order-
No.VLINE
No.LPG/CNG
D-PowerOrder-
No.**BUICK**

| | | | | | | | | | | | |
|-------------|-----|--|--------|----------------------|---|-----|------------|------|--|------------|------|
| Century | 3.0 | | 83- | E 2 bbl CID181 | 6 | 1,5 | UR45 | 2451 | | UR5IX | 7177 |
| Century | 3.0 | | 82- | E V6 | 6 | 2,0 | UR40 | 4386 | | | |
| Century | 3.0 | | 83- 85 | E V6 | 6 | 1,5 | UR45 | 2451 | | UR5IX | 7177 |
| Century | 3.1 | | 00- | J OHV V6 | 6 | 1,3 | TR55IX | 7164 | | LPG 5 | 1516 |
| Century | 3.1 | | 94- 99 | M OHV V6 | 6 | 1,3 | TR55IX | 7164 | | LPG 5 | 1516 |
| Century | 3.3 | | 89- 93 | N V6 | 6 | 1,5 | TR55 | 1048 | | LPG 5 | 1516 |
| Century | 3.8 | | 84- 85 | 3 V6 | 6 | 2,0 | UR40 | 4386 | | | |
| Century | 3.8 | | 86- 88 | 3 V6 | 6 | 1,0 | TR5 | 2238 | | LPG 5 | 1516 |
| Century | 3.8 | | 81- | A 2 bbl CID231 | 6 | 2,0 | UR40 | 4386 | | | |
| Century | 3.8 | | 86- | B V6 | 6 | 1,0 | TR5 | 2238 | | LPG 5 | 1516 |
| Century | 4.3 | | 80- 81 | S 2 bbl CID265 | 8 | 1,5 | UR45 | 2451 | | UR5IX | 7177 |
| Electra | 4.1 | | 80- | 4 4 bbl CID252 | 6 | 1,5 | UR45 | 2451 | | UR5IX | 7177 |
| Electra | 4.1 | | 81- 83 | 4 4 bbl CID252 | 6 | 2,0 | UR40 | 4386 | | | |
| Electra | 4.9 | | 80- | W 4 bbl CID301 | 8 | 1,5 | UR45 | 2451 | | UR5IX | 7177 |
| Electra | 5.0 | | 81- 83 | Y 4 bbl CID307 | 8 | 1,5 | XR40 | 2990 | | | |
| Electra | 5.7 | | 80- | R 4 bbl CID350 | 8 | 1,5 | XR40 | 2990 | | | |
| Lacrosse | 3.6 | | 05- | V6 2 FI | 6 | 1,5 | TR55 | 1048 | | LPG 5 | 1516 |
| Lacrosse | 3.6 | | 05- | V6 7 FI 217 | 6 | 1,0 | PLTR6A-10G | 3587 | | PLTR6A-10G | 3587 |
| LeSabre | 3.0 | | 86- | L V6 | 6 | 1,0 | TR5 | 2238 | | LPG 5 | 1516 |
| LeSabre | 3.8 | | 86- 88 | 3 V6 | 6 | 1,0 | TR5 | 2238 | | LPG 5 | 1516 |
| LeSabre | 3.8 | | 81- 83 | A 2 bbl CID231 | 6 | 2,0 | UR40 | 4386 | | | |
| LeSabre | 3.8 | | 81- 83 | A V6 | 6 | 2,0 | UR40 | 4386 | | | |
| LeSabre | 3.8 | | 88- 91 | C V6 | 6 | 1,5 | PTR4B-15 | 5146 | | LPG 5 | 1516 |
| LeSabre | 3.8 | | 96- 01 | K V6 | 6 | 1,5 | PTR4B-15 | 5146 | | LPG 5 | 1516 |
| LeSabre | 3.8 | | 02- | K V6 | 6 | 1,5 | PTR4B-15 | 5146 | | LPG 5 | 1516 |
| LeSabre | 3.8 | | 92- 95 | L V6 | 6 | 1,5 | PTR4B-15 | 5146 | | LPG 5 | 1516 |
| LeSabre | 4.1 | | 80- 83 | 4 4 bbl CID252 | 6 | 1,5 | UR45 | 2451 | | UR5IX | 7177 |
| LeSabre | 4.1 | | 81- | 4 4 bbl CID252 | 6 | 2,0 | UR40 | 4386 | | | |
| LeSabre | 4.1 | | 80- 84 | 4 V6 | 6 | 1,5 | UR45 | 2451 | | UR5IX | 7177 |
| LeSabre | 4.1 | | 81- 81 | 4 V6 | 6 | 2,0 | UR40 | 4386 | | | |
| LeSabre | 4.4 | | 81- | J 2 bbl CID267 | 8 | 1,1 | UR4 | 4762 | | UR5IX | 7177 |
| LeSabre | 4.4 | | 81- 81 | J V6 | 6 | 1,1 | UR4 | 4762 | | UR5IX | 7177 |
| LeSabre | 5.0 | | 81- 83 | Y 4 bbl CID307 | 8 | 1,5 | XR40 | 2990 | | | |
| LeSabre | 5.0 | | 81- 84 | Y V8 | 8 | 1,5 | XR40 | 2990 | | | |
| LeSabre | 5.0 | | 85- 90 | Y V8 | 8 | 1,5 | FR45 | 4636 | | | |
| LeSabre | 5.7 | | 80- | R 4 bbl CID350 | 8 | 1,5 | XR40 | 2990 | | | |
| LeSabre | 4.9 | | 80- | W 4 bbl CID301 | 8 | 1,5 | UR45 | 2451 | | UR5IX | 7177 |
| Park Avenue | 3.8 | | 92- 97 | 1 V6 Super Charged | 6 | 1,5 | PTR4B-15 | 5146 | | LPG 5 | 1516 |
| Park Avenue | 3.8 | | 91- | K V6 | 6 | 1,5 | PTR4B-15 | 5146 | | LPG 5 | 1516 |
| Park Avenue | 3.8 | | 02- | V6 1 FI Supercharged | 6 | 1,5 | TR55 | 1048 | | LPG 5 | 1516 |
| Park Avenue | 3.8 | | 02- | V6 K FI | 6 | 1,5 | TR55 | 1048 | | LPG 5 | 1516 |
| Regal | 3.8 | | 82- | 3 4 bbl CID231 | 6 | 1,5 | UR45 | 2451 | | UR5IX | 7177 |
| Regal | 3.8 | | 83- | 8 4 bbl CID231 | 6 | 1,5 | UR45 | 2451 | | UR5IX | 7177 |
| Regal | 3.8 | | 81- 83 | A 2 bbl CID231 | 6 | 2,0 | UR40 | 4386 | | | |
| Regal | 3.8 | | 96- | K V6 MFI | 6 | 1,5 | PTR4B-15 | 5146 | | LPG 5 | 1516 |
| Regal | 3.8 | | 96- | SC V6 MFI 1 | 6 | 1,5 | PTR4B-15 | 5146 | | LPG 5 | 1516 |
| Regal | 4.1 | | 82- 83 | 4 4 bbl CID252 | 6 | 2,0 | UR40 | 4386 | | | |
| Regal | 4.3 | | 80- 81 | S 2 bbl CID265 | 8 | 1,5 | UR45 | 2451 | | UR5IX | 7177 |
| Regal | 4.4 | | 81- 82 | J 2 bbl CID267 | 8 | 1,1 | UR4 | 4762 | | UR5IX | 7177 |
| Riviera | 3.8 | | 96- 97 | K V6 MFI | 6 | 1,5 | PTR4B-15 | 5146 | | LPG 5 | 1516 |
| Riviera | 3.8 | | 96- | SC V6 MFI 1 | 6 | 1,5 | PTR4B-15 | 5146 | | LPG 5 | 1516 |
| Riviera | 3.8 | | 82- | 3 4 bbl CID231 | 6 | 2,0 | UR40 | 4386 | | | |



ℓ kW



Cyl.

Order-
No. No.LPG/CNG
D-PowerOrder-
No.**BUICK**

| | | | | | | | | | | |
|---------|-----|--|---------|----------------|-------|------|------|--|-------|------|
| Riviera | 3.8 | | 83 - | 8 4 bbl CID231 | 6 1,5 | UR45 | 2451 | | UR5IX | 7177 |
| Riviera | 4.1 | | 81 - 83 | 4 4 bbl CID252 | 6 2,0 | UR40 | 4386 | | | |
| Riviera | 5.0 | | 80 - 83 | Y 4 bbl CID307 | 8 1,5 | XR40 | 2990 | | | |
| Skylark | 2.8 | | 80 - | 7 2 bbl CID173 | 6 1,1 | UR4 | 4762 | | UR5IX | 7177 |
| Skylark | 2.8 | | 81 - 83 | X 2 bbl CID173 | 6 1,3 | UR5 | 2139 | | UR6IX | 7348 |
| Skylark | 2.8 | | 82 - 83 | Z 2 bbl CID173 | 6 1,3 | UR5 | 2139 | | UR6IX | 7348 |

CADILLAC

| | | | | | | | | | | |
|------------------|-----|-----|---------|----------------|-------|--------|------|----|-------|------|
| Allante | 4.6 | | 87 - 90 | 7 DFI / 8 MFI | 8 1,5 | TR55 | 1048 | | LPG 5 | 1516 |
| Allante | 4.6 | | 91 - 94 | 8 / 9 MFI | 8 1,5 | TR55 | 1048 | | LPG 5 | 1516 |
| BLS 1.9D | 1.9 | 110 | 06 - | Z19DTH Fiat | 4 | YE07 | 6092 | | | |
| Brougham | 5.0 | | 91 - 92 | E TBI | 8 1,1 | UR4 | 4762 | | UR5IX | 7177 |
| Brougham | 5.7 | | 91 - 92 | 7 TBI | 8 1,3 | UR5 | 2139 | | UR6IX | 7348 |
| Brougham | 5.7 | | 93 - | 7 TBI | 8 1,1 | UR4 | 4762 | | UR5IX | 7177 |
| Catera | 3.0 | | 97 - 01 | R DOHC MFI | 6 | BKR5EK | 7956 | 23 | LPG 1 | 1496 |
| Concours | 4.6 | | 96 - 98 | 9 MFI | 8 1,5 | TR55 | 1048 | | LPG 5 | 1516 |
| Concours | 4.6 | | 95 - 95 | Y MFI | 8 1,5 | TR55 | 1048 | | LPG 5 | 1516 |
| Concours | 4.6 | | 94 - 94 | Y SFI | 8 1,5 | TR55 | 1048 | | LPG 5 | 1516 |
| CTS-V | 5.7 | 298 | 05 - | | 8 1,5 | TR55 | 1048 | | LPG 5 | 1516 |
| De Ville | 4.5 | | 90 - 90 | 3 MFI | 8 1,5 | TR55 | 1048 | | LPG 5 | 1516 |
| De Ville | 4.6 | | 01 - | 9 MFI | 8 1,5 | TR55 | 1048 | | LPG 5 | 1516 |
| De Ville | 4.6 | | 96 - 98 | Y MFI | 8 1,5 | TR55 | 1048 | | LPG 5 | 1516 |
| De Ville | 4.6 | | 99 - | Y MFI | 8 1,5 | TR55 | 1048 | | LPG 5 | 1516 |
| De Ville | 4.9 | | 91 - 91 | B MFI | 8 1,5 | TR55 | 1048 | | LPG 5 | 1516 |
| De Ville | 4.9 | | 92 - 95 | B MFI | 8 1,5 | TR55 | 1048 | | LPG 5 | 1516 |
| DeVille | 4.1 | | 80 - | 4 4 bbl CID252 | 6 1,5 | UR45 | 2451 | | UR5IX | 7177 |
| DeVille | 4.1 | | 81 - 82 | 4 4 bbl CID252 | 6 2,0 | UR40 | 4386 | | | |
| DeVille | 4.1 | | 82 - 83 | 8 EFI CID250 | 8 1,5 | TR55 | 1048 | | LPG 5 | 1516 |
| DeVille | 6.0 | | 80 - | 6 4 bbl CID368 | 8 1,2 | GR45 | 2822 | | GR5IX | 7214 |
| DeVille | 6.0 | | 81 - | 9 EFI CID368 | 8 1,2 | GR45 | 2822 | | GR5IX | 7214 |
| Eldorado | 4.1 | | 81 - 82 | 4 4 bbl CID252 | 6 1,5 | UR45 | 2451 | | UR5IX | 7177 |
| Eldorado | 4.1 | | 82 - 83 | 8 EFI CID250 | 8 1,5 | TR55 | 1048 | | LPG 5 | 1516 |
| Eldorado | 4.6 | | 93 - 93 | 9 / Y MFI | 8 1,5 | TR55 | 1048 | | LPG 5 | 1516 |
| Eldorado | 4.6 | | 94 - 98 | 9 MFI / SFI | 8 1,5 | TR55 | 1048 | | LPG 5 | 1516 |
| Eldorado | 4.6 | | 99 - | V8 MFI 9 | 8 1,5 | TR55 | 1048 | | LPG 5 | 1516 |
| Eldorado | 4.6 | | 99 - | V8 MFI Y | 8 1,5 | TR55 | 1048 | | LPG 5 | 1516 |
| Eldorado | 4.6 | | 94 - 98 | Y MFI / SFI | 8 1,5 | TR55 | 1048 | | LPG 5 | 1516 |
| Eldorado | 4.9 | | 92 - 93 | B MFI | 8 1,5 | TR55 | 1048 | | LPG 5 | 1516 |
| Eldorado | 5.7 | | 80 - | 8 EFI CID350 | 8 1,5 | XR45 | 7055 | | XR5IX | 7355 |
| Eldorado | 6.0 | | 80 - 81 | 9 EFI CID368 | 8 1,2 | GR45 | 2822 | | GR5IX | 7214 |
| Fleetwood | 4.1 | | 80 - 82 | 4 4 bbl CID252 | 6 1,5 | UR45 | 2451 | | UR5IX | 7177 |
| Fleetwood | 4.1 | | 82 - 83 | 8 EFI CID250 | 8 1,5 | TR55 | 1048 | | LPG 5 | 1516 |
| Fleetwood | 6.0 | | 80 - 82 | 6 4 bbl CID368 | 8 1,2 | GR45 | 2822 | | GR5IX | 7214 |
| Fleetwood | 6.0 | | 81 - 83 | 9 EFI CID368 | 8 1,2 | GR45 | 2822 | | GR5IX | 7214 |
| Seville | 4.1 | | 81 - 82 | 4 4 bbl CID252 | 6 1,5 | UR45 | 2451 | | UR5IX | 7177 |
| Seville | 4.1 | | 82 - 83 | 8 EFI CID250 | 8 1,5 | TR55 | 1048 | | LPG 5 | 1516 |
| Seville | 4.6 | | 99 - | V8 MFI 9 | 8 1,5 | TR55 | 1048 | | LPG 5 | 1516 |
| Seville | 4.6 | | 99 - | V8 MFI Y | 8 1,5 | TR55 | 1048 | | LPG 5 | 1516 |
| Seville | 5.7 | | 80 - | 8 EFI CID350 | 8 1,5 | XR45 | 7055 | | XR5IX | 7355 |
| Seville | 6.0 | | 80 - 81 | 9 EFI CID368 | 8 1,2 | GR45 | 2822 | | GR5IX | 7214 |
| SRX Sport Luxury | 4.6 | 239 | 10.04 - | A V8 FI | 8 1,5 | TR55 | 1048 | | LPG 5 | 1516 |
| XLR | 4.6 | 239 | 05 - | A V8 FI | 8 1,5 | TR55 | 1048 | | LPG 5 | 1516 |



ℓ kW

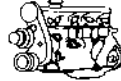

Cyl.

Order-
No. No.LPG/CNG
D-PowerOrder-
No.**CARBODIES**

| | | | | | | | | | | |
|----------------|-----|--|---------|--|---|--------|------|--|--|--|
| FL2/R Hire Car | | | 08.83 - | | | Y-208T | 1250 | | | |
| FX4R 2.25 Taxi | 2.2 | | 08.83 - | | 4 | Y-208T | 1250 | | | |

CATERHAM

| | | | | | | | | | | | |
|---------------------|-----|-----|---------|-------------|---|-----|-----------|------|----|----------|------|
| 21 | 1.6 | 85 | | K SERIES | 4 | 0,9 | BKR6E | 6962 | 28 | LPG 1 | 1496 |
| 21 Superlight/Sport | 1.6 | 100 | | K SERIES | 4 | 0,8 | BCPR7ES | 3330 | | BCPR7EIX | 5690 |
| 7 | 1.6 | 85 | | K SERIES | 4 | 0,9 | BKR6E | 6962 | 28 | LPG 1 | 1496 |
| 7 Superlight/Sport | 1.6 | 101 | | K SERIES | 4 | 0,8 | BCPR7ES | 3330 | | BCPR7EIX | 5690 |
| Seven | 1.1 | | | Honda | 4 | 0,9 | CR9EHVX-9 | 3872 | | | |
| Seven | 1.4 | | | K Series | 4 | 0,8 | BKR6ES | 3783 | 28 | LPG 1 | 1496 |
| Seven | 1.7 | 125 | | BDR | 4 | 0,6 | B8ECS | 2821 | | | |
| Seven R500 | 1.8 | | | | 4 | 0,7 | BKR7E | 6097 | | BKR7EVX | 3544 |
| Seven Super Sprint | 1.7 | 99 | | | 4 | 0,6 | B8ECS | 2821 | | | |
| Super Seven | | | 85 - | | 4 | 0,6 | B8ECS | 2841 | | | |
| Super Seven GT | 1.6 | | | FORD Kent S | 4 | 0,8 | BPR7ES | 2023 | 19 | BPR7EIX | 4055 |
| Super Seven HPC | 2.0 | 110 | 07.91 - | Opel 16V | 4 | 0,8 | BCPR7ES | 3330 | | BCPR7EIX | 5690 |
| Super Seven Sprint | 1.6 | | | Ford Kent T | 4 | 0,8 | BP7ES | 2412 | | BPR7EIX | 4055 |

CHEVROLET

| | | | | | | | | | | | |
|-----------------|-----|----|------------|-----------------------|---|-----|-----------|------|----|--------|------|
| Alero | 3.4 | | 03.99 - | LA1 | 6 | 1,5 | TR55 | 1048 | | LPG 5 | 1516 |
| Aveo 1.2 | 1.2 | 53 | 02.05 - 08 | SOHC 8V | 4 | 1,1 | BPR5EY-11 | 3028 | | LPG 2 | 1497 |
| Aveo 1.2 | 1.2 | 62 | 08 - | LMU | 4 | 0,9 | DCPR8E | 4339 | | LPG 8 | 6806 |
| Aveo 1.4 | 1.4 | 69 | 02.05 - 08 | DOHC 16V | 4 | 1,1 | BKR6E-11 | 2756 | 14 | LPG 1 | 1496 |
| Aveo 1.4 | 1.4 | 74 | 08 - | MFI DOHC | 4 | 1,1 | BKR6E-11 | 2756 | 14 | LPG 1 | 1496 |
| Aveo 1.4 16V SX | 1.4 | 69 | 12.05 - 08 | F14D3 DOHC | 4 | 1,1 | BKR6E-11 | 2756 | 14 | LPG 1 | 1496 |
| Blazer | 4.1 | | 81 - 82 | L6 D 2bbl | 6 | 1,1 | UR4 | 4762 | | UR5IX | 7177 |
| Blazer | 4.3 | | 03 - 03 | V6 X EFI | 6 | 1,0 | TR5 | 2238 | | LPG 5 | 1516 |
| Blazer | 4.3 | | 95 - 05 | V6 W EFI | 6 | 1,3 | UR5 | 2139 | | UR6IX | 7348 |
| Blazer | 4.3 | | 96 - 02 | V6 W EFI | 6 | 1,0 | TR5 | 2238 | | LPG 5 | 1516 |
| Blazer | 5.0 | | 81 - 82 | V8 F 4bbl | 8 | 1,1 | UR4 | 4762 | | UR5IX | 7177 |
| Blazer | 5.0 | | 80 - 81 | V8 G 2bbl | 8 | 1,1 | UR4 | 4762 | | UR5IX | 7177 |
| Blazer | 5.0 | | 81 - 83 | V8 H 4bbl | 8 | 1,1 | UR4 | 4762 | | UR5IX | 7177 |
| Blazer | 5.0 | | 84 - 86 | V8 H 4bbl | 8 | 1,3 | UR5 | 2139 | | UR6IX | 7348 |
| Blazer | 5.7 | | 87 - 93 | V8 K EFI | 8 | 1,3 | UR5 | 2139 | | UR6IX | 7348 |
| Blazer | 5.7 | | 94 - 94 | V8 K EFI | 8 | 1,3 | UR6 | 4079 | | UR6IX | 7348 |
| Blazer | 5.7 | | 87 - 93 | V8 K TBI | 8 | 1,3 | UR5 | 2139 | | UR6IX | 7348 |
| Blazer | 5.7 | | 94 - | V8 K TBI | 8 | 1,3 | UR6 | 4079 | | UR6IX | 7348 |
| Blazer | 5.7 | | 82 - 83 | V8 L 4bbl | 8 | 1,1 | UR4 | 4762 | | UR5IX | 7177 |
| Blazer | 5.7 | | 84 - 86 | V8 L 4bbl | 8 | 1,3 | UR5 | 2139 | | UR6IX | 7348 |
| Camaro | 2.5 | | 82 - 83 | 2 L4 EFI | 4 | 1,5 | UR45 | 2451 | | UR5IX | 7177 |
| Camaro | 2.5 | | 84 - 86 | 2 L4 EFI | 4 | 1,5 | UR55 | 6950 | | UR55IX | 7272 |
| Camaro | 2.8 | | 82 - | 1 2 bbl CID173 | 6 | 1,3 | UR5 | 2139 | | UR6IX | 7348 |
| Camaro | 2.8 | | 82 - 84 | 1 V6 2BBL/ Carburator | 6 | 1,3 | UR5 | 2139 | | UR6IX | 7348 |
| Camaro | 2.8 | | 85 - 89 | S V6 EFI | 6 | 1,3 | UR5 | 2139 | | UR6IX | 7348 |
| Camaro | 3.1 | | 90 - 92 | T V6 EFI | 6 | 1,3 | UR5 | 2139 | | UR6IX | 7348 |
| Camaro | 3.4 | | 93 - 95 | S V6 EFI | 6 | 1,3 | UR5 | 2139 | | UR6IX | 7348 |
| Camaro | 3.8 | | 01 - | | 6 | 1,5 | PTR4B-15 | 5146 | | LPG 5 | 1516 |
| Camaro | 3.8 | | 80 - 81 | A 2 bbl CID231 | 6 | 2,0 | UR40 | 4386 | | | |
| Camaro | 3.8 | | 80 - 81 | A V8 2BBL/ Carburator | 6 | 1,1 | UR40 | 4386 | | | |
| Camaro | 3.8 | | 80 - 81 | K 2 bbl CID229 | 6 | 1,1 | UR4 | 4762 | | UR5IX | 7177 |
| Camaro | 3.8 | | 80 - 81 | K V8 2BBL/ Carburator | 6 | 1,1 | UR4 | 4762 | | UR5IX | 7177 |
| Camaro | 3.8 | | 96 - | V6 MFI K | 6 | 1,5 | TR55 | 1048 | | LPG 5 | 1516 |



ℓ kW



Cyl.

Order-
No. No.LPG/CNG
D-PowerOrder-
No.**CHEVROLET**

| | | | | | | | | | | | |
|-------------|-----|-----|---------|---------------------------------------|---|-----|-----------|------|----|-----------|------|
| Camaro | 4.4 | | 80 - 81 | J 2 bbl CID267 | 8 | 1,1 | UR4 | 4762 | | UR5IX | 7177 |
| Camaro | 5.0 | | 82 - | 7 EFI CID305 | 8 | 1,1 | UR4 | 4762 | | UR5IX | 7177 |
| Camaro | 5.0 | | 82 - 83 | 7 V8 EFI | 8 | 1,1 | UR4 | 4762 | | UR5IX | 7177 |
| Camaro | 5.0 | | 88 - 92 | E V8 EFI | 8 | 1,1 | UR4 | 4762 | | UR5IX | 7177 |
| Camaro | 5.0 | | 85 - 92 | F V8 EFI | 8 | 1,1 | UR4 | 4762 | | UR5IX | 7177 |
| Camaro | 5.0 | | 86 - 86 | G V8 4BBL/ Carburator | 8 | 1,3 | UR5 | 2139 | | UR6IX | 7348 |
| Camaro | 5.0 | | 80 - 83 | H 4 bbl CID305 | 8 | 1,1 | UR4 | 4762 | | UR5IX | 7177 |
| Camaro | 5.0 | | 80 - 83 | H V8 4BBL/ Carburator | 8 | 1,1 | UR4 | 4762 | | UR5IX | 7177 |
| Camaro | 5.0 | | 84 - 87 | H V8 4BBL/ Carburator | 8 | 1,1 | UR4 | 4762 | | UR5IX | 7177 |
| Camaro | 5.0 | | 83 - | S EFI CID305 | 8 | 1,1 | UR4 | 4762 | | UR5IX | 7177 |
| Camaro | 5.0 | | 83 - 83 | S V8 EFI | 8 | 1,1 | UR4 | 4762 | | UR5IX | 7177 |
| Camaro | 5.7 | | 98 - 02 | G V8 EFI | 8 | 1,5 | TR55 | 1048 | | LPG 5 | 1516 |
| Camaro | 5.7 | | 93 - 97 | P V8 EFI | 8 | 1,5 | TR55 | 1048 | | LPG 5 | 1516 |
| Camaro | 5.7 | | 87 - 92 | V8 EFI Alu Heads | 8 | 0,9 | FR4 | 5188 | | | |
| Camaro | 5.7 | | 87 - 92 | V8 EFI Cast Iron Heads | 8 | 1,1 | UR4 | 4762 | | UR5IX | 7177 |
| Caprice | 3.8 | | 83 - | 9 2 bbl CID229 | 6 | 1,1 | UR4 | 4762 | | UR5IX | 7177 |
| Caprice | 3.8 | | 80 - | A 2 bbl CID231 | 6 | 1,5 | UR45 | 2451 | | UR5IX | 7177 |
| Caprice | 3.8 | | 81 - 83 | A 2 bbl CID231 | 6 | 2,0 | UR40 | 4386 | | | |
| Caprice | 3.8 | | 80 - 82 | K 2 bbl CID229 | 6 | 1,1 | UR4 | 4762 | | UR5IX | 7177 |
| Caprice | 4.4 | | 80 - 82 | J 2 bbl CID267 | 8 | 1,1 | UR4 | 4762 | | UR5IX | 7177 |
| Caprice | 5.0 | | 80 - 83 | H 4 bbl CID305 | 8 | 1,1 | UR4 | 4762 | | UR5IX | 7177 |
| Captiva 2.4 | 2.4 | 100 | 09.06 - | Z24SED | 4 | | BKR5EK | 7956 | 23 | LPG 1 | 1496 |
| Captiva 3.2 | 3.2 | 169 | 09.06 - | Z32SED | 6 | 1,3 | PTR5A-13 | 2467 | 25 | LPG 4 | 1511 |
| Cavalier | 2.4 | | 99 - | L4 MFI T | 4 | 1,5 | TR55 | 1048 | | LPG 5 | 1516 |
| Corvette | 5.0 | | 80 - | H 4 bbl CID305 | 8 | 1,1 | UR4 | 4762 | | UR5IX | 7177 |
| Corvette | 5.0 | | 80 - 80 | H V8 4BBL/ Carburator | 8 | 1,1 | UR4 | 4762 | | UR5IX | 7177 |
| Corvette | 5.7 | 294 | 97 - 00 | G V8 EFI | 8 | 1,5 | TR55 | 1048 | | LPG 5 | 1516 |
| Corvette | 5.7 | | 03 - 04 | V8 | 8 | 1,5 | PZTR5A-15 | 7862 | | PZTR5A-15 | 7862 |
| Corvette | 5.7 | | 82 - | 4, 6, 8, H, L, X 4 bbl, EFI CID350 | 8 | 1,1 | UR4 | 4762 | | UR5IX | 7177 |
| Corvette | 5.7 | | 96 - 96 | 5 V8 EFI | 8 | 1,5 | TR55 | 1048 | | LPG 5 | 1516 |
| Corvette | 5.7 | | 80 - 81 | 6 V8 4BBL/ Carburator | 8 | 1,1 | UR4 | 4762 | | UR5IX | 7177 |
| Corvette | 5.7 | | 82 - 84 | 8 V8 EFI | 8 | 1,1 | UR4 | 4762 | | UR5IX | 7177 |
| Corvette | 5.7 | | 85 - 85 | 8 V8 EFI | 8 | 1,3 | UR5 | 2139 | | UR6IX | 7348 |
| Corvette | 5.7 | | 86 - 91 | 8 V8 EFI Alu Heads | 8 | 0,9 | FR4 | 5188 | | | |
| Corvette | 5.7 | | 86 - 87 | 8 V8 EFI Cast Iron Heads | 8 | 1,3 | UR5 | 2139 | | UR6IX | 7348 |
| Corvette | 5.7 | | 88 - 91 | 8 V8 EFI Cast Iron Heads | 8 | 1,1 | UR4 | 4762 | | UR5IX | 7177 |
| Corvette | 5.7 | | 01 - 03 | G V8 EFI | 8 | 1,5 | TR55 | 1048 | | LPG 5 | 1516 |
| Corvette | 5.7 | | 93 - 95 | J V8 EFI | 8 | 1,5 | TR55 | 1048 | | LPG 5 | 1516 |
| Corvette | 5.7 | | 90 - 92 | J V8 EFI ZR1 | 8 | 1,5 | TR55 | 1048 | | LPG 5 | 1516 |
| Corvette | 5.7 | | 92 - 96 | P V8 EFI | 8 | 1,5 | TR55 | 1048 | | LPG 5 | 1516 |
| Corvette | 5.7 | | 01 - 01 | S V8 EFI | 8 | 1,5 | TR55 | 1048 | | LPG 5 | 1516 |
| Corvette | 6.0 | | 05 - | V8 | 8 | 1,5 | PZTR5A-15 | 7862 | | PZTR5A-15 | 7862 |
| El Camino | 3.8 | | 83 - | 9, K 2 bbl CID229 | 6 | 1,1 | UR4 | 4762 | | UR5IX | 7177 |
| El Camino | 3.8 | | 81 - 83 | A 2 bbl CID231 | 6 | 2,0 | UR40 | 4386 | | | |
| Epica | 2.0 | 106 | 06.06 - | XK | 6 | | BKUR6ETB | 6992 | | | |
| Epica | 2.5 | 115 | 06.06 - | | 6 | 1,1 | IFR6E11 | 6741 | | IFR6E11 | 6741 |
| Evanda | 2.0 | 96 | 02.05 - | T20SED DOHC 16v | 4 | | BKR5EK | 7956 | 23 | LPG 1 | 1496 |
| Impala | 3.8 | | 83 - | 9 2 bbl CID229 | 6 | 1,1 | UR4 | 4762 | | UR5IX | 7177 |
| Impala | 3.8 | | 80 - | A 2 bbl CID231 | 6 | 1,5 | UR45 | 2451 | | UR5IX | 7177 |
| Impala | 3.8 | | 81 - 83 | A 2 bbl CID231 | 6 | 2,0 | UR40 | 4386 | | | |
| Impala | 3.8 | | 80 - 82 | K 2 bbl CID229 | 6 | 1,1 | UR4 | 4762 | | UR5IX | 7177 |



ℓ kW



Cyl.

Order-
No.VLINE
No.LPG/CNG
D-PowerOrder-
No.**CHEVROLET**

| | | | | | | | | | | | |
|----------------------|-----|-----|------------|------------------|---|-----|------------|------|----|---------|------|
| Impala | 4.4 | | 80 - 82 | J 2 bbl CID267 | 8 | 1,1 | UR4 | 4762 | | UR5IX | 7177 |
| Impala | 5.7 | | 83 - | 6 4 bbl CID350 | 8 | 1,1 | UR4 | 4762 | | UR5IX | 7177 |
| Kalos 1.2 | 1.2 | 53 | 02.05 - | B12S1 | 4 | 1,1 | BPR5EY-11 | 3028 | | LPG 2 | 1497 |
| Kalos 1.4 | 1.4 | 61 | 02.05 - | F14S3 SOHC | 4 | 0,8 | BPR6ES | 7822 | 2 | LPG 2 | 1497 |
| Kalos 1.4 16V SX | 1.4 | 69 | 02.05 - | F14D3 DOHC | 4 | 1,1 | BKR6E-11 | 2756 | 14 | LPG 1 | 1496 |
| Lacetti | 1.4 | 70 | 02.05 - | F14D3 | 4 | 1,1 | BKR6E-11 | 2756 | 14 | LPG 1 | 1496 |
| Lacetti | 1.6 | 80 | 02.05 - | F16D3 | 4 | 1,1 | BKR6E-11 | 2756 | 14 | LPG 1 | 1496 |
| Lacetti | 1.8 | 89 | 02.05 - | T18SED | 4 | | BKR5EK | 7956 | 23 | LPG 1 | 1496 |
| Lancetti 1.8 | 1.8 | 89 | 08.05 - | F18D3 | 4 | | BKUR6ETB | 6992 | | | |
| Lumina | 3.8 | | 98 - | V6 MFI K | 6 | 1,5 | PTR4B-15 | 5146 | | LPG 5 | 1516 |
| Malibu | 2.4 | | 97 - 99 | T MFI DOHC | 4 | 1,5 | TR55 | 1048 | | LPG 5 | 1516 |
| Malibu | 3.1 | | 00 - | J V6 SFI | 6 | 1,5 | TR55 | 1048 | | LPG 5 | 1516 |
| Malibu | 3.1 | | 97 - 99 | M V6 MFI | 6 | 1,5 | TR55 | 1048 | | LPG 5 | 1516 |
| Malibu | 3.8 | | 83 - | 9 2 bbl CID229 | 6 | 1,1 | UR4 | 4762 | | UR5IX | 7177 |
| Malibu | 3.8 | | 83 - | 9 V6 2Verg./Cab. | 6 | 1,1 | UR4 | 4762 | | UR5IX | 7177 |
| Malibu | 3.8 | | 81 - 83 | A 2 bbl CID231 | 6 | 2,0 | UR40 | 4386 | | | |
| Malibu | 3.8 | | 81 - 83 | A V6 2Verg./Cab. | 6 | 2,0 | UR40 | 4386 | | | |
| Malibu | 3.8 | | 80 - 82 | K 2 bbl CID229 | 6 | 1,1 | UR4 | 4762 | | UR5IX | 7177 |
| Malibu | 3.8 | | 80 - 82 | K V6 2Verg./Cab. | 6 | 1,1 | UR4 | 4762 | | UR5IX | 7177 |
| Malibu | 5.7 | | 81 - 81 | L V8 4Verg./Cab. | 8 | 1,1 | UR4 | 4762 | | UR5IX | 7177 |
| Matiz | 0.8 | 38 | 02.05 - | F8CV | 3 | 1,1 | BCPR5EY-11 | 4120 | | LPG 3 | 1498 |
| Matiz | 1.0 | 47 | 02.05 - | B10S | 4 | 1,1 | BCPR5EY-11 | 4120 | | LPG 3 | 1498 |
| Metro | 1.0 | | 98 - | L3 TBI 6 | 3 | 1,1 | BPR6ES-11 | 4824 | 13 | LPG 2 | 1497 |
| Metro | 1.3 | | 98 - | L4 TBI 9 | 4 | 1,1 | BKR6E-11 | 2756 | 14 | LPG 1 | 1496 |
| Monte Carlo | 3.8 | | 80 - 81 | 3 4 bbl CID231 | 6 | 1,1 | UR4 | 4762 | | UR5IX | 7177 |
| Monte Carlo | 3.8 | | 83 - | 9 2 bbl CID229 | 6 | 1,1 | UR4 | 4762 | | UR5IX | 7177 |
| Monte Carlo | 3.8 | | 81 - 83 | A 2 bbl CID231 | 6 | 2,0 | UR40 | 4386 | | | |
| Monte Carlo | 3.8 | | 80 - 82 | K 2 bbl CID229 | 6 | 1,1 | UR4 | 4762 | | UR5IX | 7177 |
| Monte Carlo | 3.8 | | 96 - | V6 MFI K | 6 | 1,5 | PTR4B-15 | 5146 | | LPG 5 | 1516 |
| Niva | 1.8 | 92 | 02.05 - | Z18XE | 4 | | BKR5EK | 7956 | 23 | LPG 1 | 1496 |
| Nubira 1.6 | 1.6 | 80 | 02.05 - | A16DMS DOHC | 4 | 1,1 | BKR6E-11 | 2756 | 14 | LPG 1 | 1496 |
| Nubira 1.8 CDX | 1.8 | 89 | 02.05 - | T18SED | 4 | | BKR5EK | 7956 | 23 | LPG 1 | 1496 |
| Nubria 1.8 | 1.8 | 89 | 08.05 - | F18D3 | 4 | | BKUR6ETB | 6992 | | | |
| Prizum | 1.8 | | 98 - 99 | L4 MPI 8 DOHC | 4 | | BKR5EKB-11 | 3967 | | | |
| Prizum | 1.8 | | 00 - | L4 MPI 8 DOHC | 4 | 1,1 | IFR5T11 | 4996 | | IFR5T11 | 4996 |
| Rezzo / Tacuma | 1.8 | 72 | 00 - | F18S2 SOHC | 4 | 0,9 | BPR5ES | 7422 | 6 | LPG 2 | 1497 |
| Rezzo / Tacuma U100 | 1.6 | 77 | 02.05 - | A16DMS | 4 | 1,1 | BKR5E-11 | 6953 | 33 | LPG 1 | 1496 |
| Rezzo / Tacuma U100 | 2.0 | 89 | 02.05 - | T20SED | 4 | | BKR5EK | 7956 | 23 | LPG 1 | 1496 |
| Suburban | 5.7 | 140 | 04.95 - | LO5 V8-EFI | 8 | 0,8 | BPR6FS | 2623 | | | |
| Tahoe | 4.8 | | 00 - 00 | V FI V8 | 8 | 1,5 | TR55 | 1048 | | LPG 5 | 1516 |
| Tahoe | 4.8 | | 01 - | V FI V8 | 8 | 1,5 | TR55 | 1048 | | LPG 5 | 1516 |
| Tahoe | 5.3 | 201 | 00 - | T FI V8 | 8 | 1,5 | TR55 | 1048 | | LPG 5 | 1516 |
| Tahoe | 5.3 | | 04 - | Z FI V8 | 8 | 1,5 | TR55 | 1048 | | LPG 5 | 1516 |
| Tahoe | 5.3 | | 02 - 03 | Z FLEX V8 | 8 | 1,5 | TR55 | 1048 | | LPG 5 | 1516 |
| Tahoe | 5.3 | | 05 - | Z FLEX V8 323 | 8 | 1,5 | TR55 | 1048 | | LPG 5 | 1516 |
| Tahoe | 5.7 | 147 | 04.96 - 00 | R V8 | 8 | 1,5 | TR55 | 1048 | | LPG 5 | 1516 |
| Tracker | 1.6 | | 98 - | L4 MFI 6 | 4 | 1,1 | BKR6E-11 | 2756 | 14 | LPG 1 | 1496 |
| Trail Blazer 4.2 LTZ | 4.2 | 201 | 02 - 03 | S EFI | 6 | 1,3 | PTR5A-13 | 2467 | 25 | LPG 4 | 1511 |
| Trail Blazer 5.3 | 5.3 | | 03 - | V8 P EFI | 8 | 1,5 | TR55 | 1048 | | LPG 5 | 1516 |
| Viva | 1.8 | 92 | 02.05 - | Z18XE | 4 | | BKR5EK | 7956 | 23 | LPG 1 | 1496 |



l kW



Cyl.

Order-
No. No.LPG/CNG
D-PowerOrder-
No.**CHRYSLER**

| | | | | | | | | | | | |
|----------------|-----|-----|-------------|-----------------------------|----|-----|------------|------|----|------------|------|
| 300 | 2.7 | | 05- | V6 R FI Dir. Ign. | 6 | 1,3 | LZTR5A-13 | 4612 | | | |
| 300 C | 2.7 | 142 | 01.05- | V6 | 6 | 1,3 | LZTR5A-13 | 4612 | | | |
| 300 C | 3.5 | 183 | 07.04- | V6 G FI | 6 | 1,3 | ZFR5LP-13G | 7781 | | ZFR5LP-13G | 7781 |
| 300 C | 5.7 | 250 | 07.04- | V8 HEMI | 8 | 1,1 | LZTR4A-11 | 5444 | | | |
| 300 C SRT8 | 6.1 | 316 | 06- | W V | 8 | 1,3 | LZTR5A-13 | 4612 | | | |
| 300 M | 2.7 | 150 | 08.00-09.04 | V6 EER | 6 | 1,3 | LZTR5A-13 | 4612 | | | |
| 300 M | 3.5 | 189 | 09.99- | V6 G FI | 6 | 1,3 | ZFR5LP-13G | 7781 | | ZFR5LP-13G | 7781 |
| 300 M | 3.5 | | 03- | V6 K FI Dir.Ign. | 6 | 1,3 | ZFR5LP-13G | 7781 | | ZFR5LP-13G | 7781 |
| 300C | 3.0 | 160 | 09.05- | | 6 | | Y8002AS | 6287 | | D-POWER 51 | 6287 |
| Cirrus | 2.4 | | 99- | X DOHC | 4 | 1,3 | FR45 | 4636 | | | |
| Cirrus | 2.5 | | 95- | V6 MPI H DOHC | 6 | 1,1 | PFR5G-11 | 2647 | | PFR6G-11 | 5555 |
| Concorde | 2.7 | | 98- | V6 MPI R DOHC | 6 | 1,3 | PTR5A-13 | 2467 | 25 | LPG 4 | 1511 |
| Concorde | 3.3 | | 94- 94 | V6 FF U | 6 | 1,2 | GR45 | 2822 | | GR5IX | 7214 |
| Concorde | 3.3 | | 93- 96 | V6 MPI T | 6 | 1,2 | GR45 | 2822 | | GR5IX | 7214 |
| Concorde | 3.5 | | 93- 97 | V6 MPI F | 6 | 0,9 | FR5-1 | 7252 | | | |
| Cordoba | 3.7 | | 80- 82 | C, D, E 1 bbl, 2 bbl CID225 | 6 | 1,1 | UR4 | 4762 | | UR5IX | 7177 |
| Cordoba | 3.7 | | 83- | H 1 bbl CID225 | 6 | 1,1 | UR4 | 4762 | | UR5IX | 7177 |
| Cordoba | 5.2 | | 81- 82 | M 4 bbl CID318 | 8 | 0,9 | GR4 | 7038 | | GR5IX | 7214 |
| Cordoba | 5.2 | | 83- | P 2 bbl CID318 | 8 | 0,9 | GR4 | 7038 | | GR5IX | 7214 |
| Crossfire | 3.2 | 160 | 03- | engine Mercedes SLK | 6 | 1,0 | IFR6D10 | 5344 | | LPG 1 | 1496 |
| Crossfire SRT6 | 3.2 | 247 | | Supercharged | 6 | 1,1 | BKR5ES-11 | 2382 | 33 | LPG 1 | 1496 |
| Daytona | 2.5 | 114 | 92- | EDT L4 Turbo | 4 | 0,8 | BPR6ES | 7822 | 2 | LPG 2 | 1497 |
| Dodge Viper | 8.0 | | 96- | E MPI V10 | 10 | 0,9 | FR5-1 | 7252 | | | |
| ES | 2.2 | 105 | 88- 88 | EDR 2,2 Turbo | 4 | 0,8 | BPR6ES | 7822 | 2 | LPG 2 | 1497 |
| ES | 2.5 | 72 | 88- 89 | EDM 2,5 | 4 | 0,8 | BPR6ES | 7822 | 2 | LPG 2 | 1497 |
| ES | 2.5 | | 89- 89 | EDT 2,5 | 4 | 0,8 | BPR6ES | 7822 | 2 | LPG 2 | 1497 |
| GS Turbo 2 | 2.2 | 130 | 88- 89 | EDS Turbo2 | 4 | 0,8 | BPR6ES | 7822 | 2 | LPG 2 | 1497 |
| GTS | 2.2 | 109 | 88- 88 | EDR | 4 | 0,8 | BPR6ES | 7822 | 2 | LPG 2 | 1497 |
| GTS | 2.5 | 72 | 88- 89 | EDM | 4 | 0,8 | BPR6ES | 7822 | 2 | LPG 2 | 1497 |
| GTS | 2.5 | 108 | 89- 89 | EDT | 4 | 0,8 | BPR6ES | 7822 | 2 | LPG 2 | 1497 |
| GTS Shelby | 2.2 | 130 | 89- 89 | EDS | 4 | 0,8 | BPR6ES | 7822 | 2 | LPG 2 | 1497 |
| Imperial | 3.3 | | 90- 91 | V6 MPI 3 | 6 | 1,2 | GR45 | 2822 | | GR5IX | 7214 |
| Imperial | 3.8 | | 91- 93 | V6 MPI L | 6 | 1,2 | GR45 | 2822 | | GR5IX | 7214 |
| Le Baron | 2.2 | 105 | 88- 88 | EDR | 4 | 0,8 | BPR6ES | 7822 | 2 | LPG 2 | 1497 |
| Le Baron | 2.5 | 72 | 88- 89 | EDM | 4 | 0,8 | BPR6ES | 7822 | 2 | LPG 2 | 1497 |
| Le Baron | 2.5 | 108 | 89- | EDT | 4 | 0,8 | BPR6ES | 7822 | 2 | LPG 2 | 1497 |
| Le Baron | 3.0 | 100 | 90- 95 | EFA V6 | 6 | 1,1 | BPR5ES-11 | 4424 | | LPG 2 | 1497 |
| Le Baron GTC | 2.2 | | 89- 89 | EDS | 4 | 0,8 | BPR6ES | 7822 | 2 | LPG 2 | 1497 |
| LeBaron | 3.7 | | 81- | E 1 bbl CID225 | 6 | 1,1 | UR4 | 4762 | | UR5IX | 7177 |
| LeBaron | 3.7 | | 81- | F 1 bbl CID225 | 6 | 1,1 | UR4 | 4762 | | UR5IX | 7177 |
| LeBaron | 5.2 | | 81- | K 2 bbl CID318 | 8 | 0,9 | GR4 | 7038 | | GR5IX | 7214 |
| LeBaron | 5.2 | | 81- | L 2 bbl CID318 | 8 | 0,9 | GR4 | 7038 | | GR5IX | 7214 |
| LeBaron | 5.2 | | 81- | M 4 bbl CID318 | 8 | 0,9 | GR4 | 7038 | | GR5IX | 7214 |
| LeBaron | 5.2 | | 81- | N 4 bbl CID318 | 8 | 0,9 | GR4 | 7038 | | GR5IX | 7214 |
| Neon | 1.8 | | 03.98-10.99 | | 4 | 0,9 | BKR6E | 6962 | 28 | LPG 1 | 1496 |
| Neon LE | 2.0 | 98 | 01.95- | ECB 16V | 4 | 0,8 | BCPR6ES | 2330 | 12 | LPG 3 | 1498 |
| New Yorker | 3.3 | | 90- 93 | V6 MPI R | 6 | 1,2 | GR45 | 2822 | | GR5IX | 7214 |
| New Yorker | 3.5 | | 94- 96 | V6 MPI F | 6 | 0,9 | FR5-1 | 7252 | | | |
| New Yorker | 3.7 | | 82- | E 1 bbl CID225 | 6 | 1,1 | UR4 | 4762 | | UR5IX | 7177 |
| New Yorker | 3.8 | | 91-93.93 | V6 MPI U | 6 | 1,2 | GR45 | 2822 | | GR5IX | 7214 |
| New Yorker | 5.2 | | 80- | H 2 bbl CID318 | 8 | 0,9 | GR4 | 7038 | | GR5IX | 7214 |
| New Yorker | 5.2 | | 81- 82 | K, M 2 bbl, 4 bbl CID318 | 8 | 0,9 | GR4 | 7038 | | GR5IX | 7214 |



ℓ kW



Cyl.

Order-
No.VLINE
No.LPG/CNG
D-PowerOrder-
No.**CHRYSLER**

| | | | | | | | | | | | |
|-----------------|-----|-----|-------------|----------------|---|-----|------------|------|----|------------|------|
| Newport | 3.7 | | 80 - | C 1 bbl CID225 | 6 | 1,1 | UR4 | 4762 | | UR5IX | 7177 |
| Newport | 3.7 | | 81 - | E 1 bbl CID225 | 6 | 1,1 | UR4 | 4762 | | UR5IX | 7177 |
| Newport | 5.2 | | 81 - | K 2 bbl CID318 | 8 | 0,9 | GR4 | 7038 | | GR5IX | 7214 |
| Newport | 5.2 | | 81 - | L 2 bbl CID318 | 8 | 0,9 | GR4 | 7038 | | GR5IX | 7214 |
| Newport | 5.2 | | 81 - | M 4 bbl CID318 | 8 | 0,9 | GR4 | 7038 | | GR5IX | 7214 |
| PT Cruiser | 1.6 | 85 | 06.01 - | | 4 | | only OES | | | | |
| PT Cruiser | 2.0 | 104 | 06.00 - | | 4 | 1,1 | LZTR4A-11 | 5444 | | | |
| PT Cruiser CRD | 2.2 | 110 | 03.02 - | | 4 | ■ | Y-745U | 6346 | | D-POWER 11 | 6346 |
| PT Cruiser GT | 2.4 | 164 | 08.03 - | EDV | 4 | 1,1 | LZTR4A-11 | 5444 | | | |
| Saratoga | 2.5 | 72 | 90 - 94 | EDM | 4 | 0,8 | BPR6ES | 7822 | 2 | LPG 2 | 1497 |
| Saratoga | 3.0 | 104 | 90 - 94 | EFA V6 | 6 | 1,1 | BPR5ES-11 | 4424 | | LPG 2 | 1497 |
| Sebring | 2.0 | 104 | 06.01 - | EC4 | 4 | 1,1 | LZTR4A-11 | 5444 | | | |
| Sebring | 2.0 | | 95 - 99 | L4 MPI Y DOHC | 4 | 1,1 | BKR6EVX-11 | 3540 | | LPG 1 | 1496 |
| Sebring | 2.4 | | 01 - | 4G64 SOHC | 4 | 1,1 | BKR5E-11 | 6953 | 33 | LPG 1 | 1496 |
| Sebring | 2.4 | | 96 - 98 | L4 MPI X DOHC | 4 | 1,1 | FR45 | 4636 | | | |
| Sebring | 2.5 | | 95 - 99 | V6 MPI N DOHC | 6 | 1,1 | PFR5G-11 | 2647 | | PFR6G-11 | 5555 |
| Sebring | 2.7 | 149 | 04.01 - | V6 R DOHC | 6 | | only OES | | | | |
| Sebring 2.0 CRD | 2.0 | 103 | 07 - | engine by VW | 4 | ■ | Y-607AS | 7560 | | D-POWER 50 | 7560 |
| Stratus | 2.0 | 96 | 00 - | | 4 | 0,9 | BKR6E | 6962 | 28 | LPG 1 | 1496 |
| Stratus | 2.0 | 98 | 95 - 00 | ECB 16V | 4 | 0,8 | BCPR6ES | 2330 | 12 | LPG 3 | 1498 |
| Stratus | 2.5 | 120 | 04.95 - | EEB V6 MPI | 6 | 1,1 | PFR6B-11 | 4014 | | PFR7B | 4853 |
| Vision | 3.5 | 155 | 94 - | EGE V6 MPI | 6 | 0,9 | FR5-1 | 7252 | | | |
| Voyager 1 | 2.5 | 72 | 88 - 90 | EDM | 4 | 0,8 | BPR6ES | 7822 | 2 | LPG 2 | 1497 |
| Voyager 1 | 3.0 | 100 | 88 - 91 | EFA | 6 | 1,1 | BPR5ES-11 | 4424 | | LPG 2 | 1497 |
| Voyager 2 | 2.0 | 98 | 97-01.01 | ECB COO | 4 | 0,9 | BKR6E | 6962 | 28 | LPG 1 | 1496 |
| Voyager 2 | 2.4 | 110 | 96-01.01 | EDZ B00 | 4 | 1,1 | ZFR5A-11 | 5084 | | LPG 6 | 1565 |
| Voyager 2 | 2.5 | 72 | 91 - 95 | EDM | 4 | 0,8 | BPR6ES | 7822 | 2 | LPG 2 | 1497 |
| Voyager 2 | 2.5 | 88 | 04.92-04.95 | VM 425 CLIRE | 4 | ■ | Y-923U | 3380 | | D-POWER 1 | 7906 |
| Voyager 2 | 2.5 | 88 | 05.95-01.01 | VM HR425 CLIEE | 4 | ■ | Y-741U | 6943 | | D-POWER 20 | 6943 |
| Voyager 2 | 2.5 | 88 | 04.92-04.95 | VM HR-492 | 4 | ■ | Y-923U | 3380 | | D-POWER 1 | 7906 |
| Voyager 2 | 3.3 | 116 | 96-01.01 | EGA V6 MPI R | 6 | 0,9 | GR4IX | 7149 | | GR5IX | 7214 |
| Voyager 2 | 3.3 | 120 | 91 - 95 | EGA V6 MPI R | 6 | 1,3 | GR4 | 7038 | | GR5IX | 7214 |
| Voyager 2 | 3.8 | 122 | 96-01.01 | EGH V6 MPI | 6 | 0,9 | GR4 | 7038 | | GR5IX | 7214 |
| Voyager 3 | 2.4 | 108 | 03.01 - | EDZ | 4 | 1,3 | LZTR5A-13 | 4612 | | | |
| Voyager 3 | 2.4 | 112 | 00 - | | 4 | 1,3 | FR45 | 4636 | | | |
| Voyager 3 | 3.3 | 128 | 03.01 - | EGA | 6 | 1,3 | LZTR5A-13 | 4612 | | | |
| Wrangler Jeep | 2.5 | | 01.93-01.01 | | 4 | 0,9 | FR5-1 | 7252 | | | |
| Wrangler Jeep | 4.0 | | 93 - 99 | | 6 | 0,9 | FR5-1 | 7252 | | | |

CITROEN

| | | | | | | | | | | | |
|---------------|-----|----|-------------|-------------------|---|-----|---------|------|----|-------|------|
| AX 1.0i | 1.0 | 30 | 10.86 - | TU9 | 4 | 0,7 | BCP6ES | 4930 | 17 | LPG 3 | 1498 |
| AX 1.0i | 1.0 | 37 | 07.92 - | TU9.M Cat. | 4 | | BKR5EK | 7956 | 23 | LPG 1 | 1496 |
| AX 1.0i | 1.0 | 37 | 03.95 - | TU9M CDZ | 4 | | BKR5EK | 7956 | 23 | LPG 1 | 1496 |
| AX 1.0i | 1.0 | | 09.86-06.92 | TU9 C1A | 4 | 0,8 | BCP5ES | 7496 | 16 | LPG 3 | 1498 |
| AX 1.0i | 1.0 | | 07.92-02.95 | TU9M CDZ | 4 | 0,8 | BCPR5ES | 6130 | 32 | LPG 3 | 1498 |
| AX 1.1 | 1.1 | 44 | 07.92-06.95 | TU1M HDZ Cat. | 4 | 0,8 | BCPR5ES | 6130 | 32 | LPG 3 | 1498 |
| AX 1.1i | 1.1 | | 09.86-06.92 | TU1 H1A | 4 | 0,8 | BCP5ES | 7496 | 16 | LPG 3 | 1498 |
| AX 1.1i | 1.1 | | 07.92-06.95 | TU1M HDZ | 4 | 0,8 | BCPR5ES | 6130 | 32 | LPG 3 | 1498 |
| AX 1.1i | 1.1 | | 07.95 - | TU1M HDZ | 4 | | BKR5EK | 7956 | 23 | LPG 1 | 1496 |
| AX 1.3i Sport | 1.3 | 69 | 02.87-12.92 | TU24 M4A | 4 | | BKUR7ET | 7873 | | PFR7Q | 7963 |
| AX 1.4 | 1.4 | | 09.86-12.92 | TU3 K1A, TU3A K1G | 4 | 0,8 | BCP5ES | 7496 | 16 | LPG 3 | 1498 |
| AX 1.4 | 1.4 | | 07.92 - | TU3M Cat. | 4 | 0,8 | BCPR5ES | 6130 | 32 | LPG 3 | 1498 |



e kW



Cyl.

Order-
No. No.LPG/CNG
D-PowerOrder-
No.**CITROEN**

| | | | | | | | | | | | |
|--------------------------|-----|-----|---------------|-----------------|---|-----|---------|------|----|------------|------|
| AX 1.4 GT | 1.4 | | 10.87 - 12.92 | TU3S K2A | 4 | 0,7 | BCP6ES | 4930 | 17 | LPG 3 | 1498 |
| AX 1.4 Gti | 1.4 | | 07.92 - | TU3J2 KFZ | 4 | | BKR6EK | 2288 | 20 | LPG 1 | 1496 |
| AX 1.4 Gti | 1.4 | | 09.91 - 12.92 | TU3J2 K6B | 4 | | BKR6EK | 2288 | 20 | LPG 1 | 1496 |
| AX 1.4i | 1.4 | 55 | 07.94 - | TU3FM | 4 | | BKR6EK | 2288 | 20 | LPG 1 | 1496 |
| AX 1.4i | 1.4 | 55 | 07.92 - | TU3MC Cat. | 4 | | BKR6EK | 2288 | 20 | LPG 1 | 1496 |
| AX 1.4i | 1.4 | | 07.92 - 06.95 | TU3MC KDX | 4 | 0,8 | BCPR5ES | 6130 | 32 | LPG 3 | 1498 |
| AX 1.4i | 1.4 | | 07.95 - | TU3MC KDX | 4 | | BKR6EK | 2288 | 20 | LPG 1 | 1496 |
| AX 1.4i GT | 1.4 | 55 | 07.92 - | TU3FM Cat. | 4 | | BKR6EK | 2288 | 20 | LPG 1 | 1496 |
| AX 1.4i GT | 1.4 | | 07.92 - 06.95 | TU3MC KDX | 4 | 0,8 | BCPR5ES | 6130 | 32 | LPG 3 | 1498 |
| AX 1.4i Gti | 1.4 | | 09.91 - 12.92 | TU3FJ2Z | 4 | | BKR6EK | 2288 | 20 | LPG 1 | 1496 |
| AX D | 1.4 | 39 | 09.88 - 09.94 | TUD 3 L | 4 | █ | Y-910J | 3617 | | D-POWER 3 | 3617 |
| AX D | 1.5 | 40 | 10.94 - 12.99 | TUD 5 VJZ | 4 | █ | Y-503J | 1009 | | D-POWER 10 | 1009 |
| AXEL 11 | | | | G11/631 | 4 | 0,8 | BP6EFS | 3812 | 5 | LPG 5 | 1516 |
| AXEL 12 | | | | T13/653 | 4 | 0,8 | BP6EFS | 3812 | 5 | LPG 5 | 1516 |
| AXEL 13 | | | | T13/654 | 4 | 0,8 | BP6EFS | 3812 | 5 | LPG 5 | 1516 |
| AZU 250 AK 400 | | | | A06/... | 2 | 0,6 | BP6HS | 4511 | 18 | BPR6HIX | 4085 |
| Berlingo | 1.8 | 43 | 07.96 - 08.98 | XUD7 A9A | 4 | █ | Y-923U | 3380 | | D-POWER 1 | 7906 |
| Berlingo | 1.8 | 43 | 09.98 - 03.99 | XUD7 A9A | 4 | █ | Y-938R | 5267 | | D-POWER 1 | 7906 |
| Berlingo | 1.8 | 51 | 09.98 - 03.99 | DW8 WJZ | 4 | █ | Y-503R | 4279 | | D-POWER 10 | 1009 |
| Berlingo | 1.8 | 66 | 09.98 - 03.99 | DW8TD | 4 | █ | Y-503R | 4279 | | D-POWER 10 | 1009 |
| Berlingo | 1.9 | 51 | 07.96 - 09.98 | XUD9A D9B / DJY | 4 | █ | Y-923U | 3380 | | D-POWER 1 | 7906 |
| Berlingo | 1.9 | 52 | 09.98 - 12.02 | XUD9A | 4 | █ | Y-938R | 5267 | | D-POWER 1 | 7906 |
| Berlingo | 2.0 | 100 | 11.06 - | DW10BTED4 | 4 | █ | Y1005J | 7957 | | D-POWER 56 | 7957 |
| Berlingo | 2.0 | 81 | 05.02 - 10.06 | DW10ATED4 | 4 | █ | Y1005J | 7957 | | D-POWER 56 | 7957 |
| Berlingo | 2.0 | 88 | 11.06 - | DW10UTED4 | 4 | █ | Y1005J | 7957 | | D-POWER 56 | 7957 |
| Berlingo 1.4i | 1.4 | 55 | 07.96 - 12.99 | TU3JP-KFX,KFW | 4 | █ | BKR6EK | 2288 | 20 | LPG 1 | 1496 |
| Berlingo HDI | 2.0 | 66 | 10.99 - | DW10TD | 4 | █ | Y-504R | 4359 | | D-POWER 24 | 1441 |
| Berlingo Multispace | 1.9 | 51 | 09.98 - 12.02 | DW8 WJZ | 4 | █ | Y-503R | 4279 | | D-POWER 10 | 1009 |
| Berlingo Multispace | 1.9 | 51 | 01.97 - 09.98 | XUD9A D9B / DJY | 4 | █ | Y-923U | 3380 | | D-POWER 1 | 7906 |
| Berlingo Multispace 1.4i | 1.4 | 55 | 01.97 - 12.99 | TU3JP KFX, KFW | 4 | | BKR6EK | 2288 | 20 | LPG 1 | 1496 |
| Berlingo Multispace 1.4i | 1.4 | 55 | 01.00 - | TU3JP KFX, KFW | 4 | 0,9 | BKR6EZ | 4619 | 38 | LPG 1 | 1496 |
| Berlingo Multispace 1.6i | 1.6 | 81 | 02.01 - | TU5JP4 NFU | 4 | 0,9 | LF6B | 6677 | | LPG 7 | 1640 |
| Berlingo Multispace 1.8i | 1.8 | 66 | 07.97 - | XU7JB LFX | 4 | | BKR6EK | 2288 | 20 | LPG 1 | 1496 |
| Berlingo Multispace Hdi | 2.0 | 66 | 10.99 - | DW10TD | 4 | █ | Y-504R | 4359 | | D-POWER 24 | 1441 |
| Berlingo 1.1i | 1.1 | 44 | 07.96 - | TU1M HDZ | 4 | | BKR6EK | 2288 | 20 | LPG 1 | 1496 |
| Berlingo 1.4i | 1.4 | 55 | 01.00 - | TU3JP KFX | 4 | 0,9 | BKR6EZ | 4619 | 38 | LPG 1 | 1496 |
| Berlingo 1.6i 16V | 1.6 | 81 | 02.01 - | TU5JP4 NFU | 4 | 0,9 | LF6B | 6677 | | LPG 7 | 1640 |
| Berlingo 1.8i | 1.8 | 66 | 07.96 - | XU7JB LFX | 4 | | BKR6EK | 2288 | 20 | LPG 1 | 1496 |
| Berlingo Hdi | 1.4 | 55 | 01.05 - | DV4TD | 4 | █ | YE04 | 1684 | | D-POWER 40 | 1684 |
| Berlingo Hdi | 1.6 | 66 | 07.06 - | DV6 | 4 | █ | YE04 | 1684 | | D-POWER 40 | 1684 |
| BX 14 | 1.4 | 47 | 07.88 - | TU3.A | 4 | 0,8 | BCP5ES | 7496 | 16 | LPG 3 | 1498 |
| BX 14 | 1.4 | 47 | 09.82 - 06.88 | XY6C | 4 | 0,8 | BP6EFS | 3812 | 5 | LPG 5 | 1516 |
| BX 14 | 1.4 | 47 | 09.82 - 06.88 | XY6D | 4 | 0,8 | BP6EFS | 3812 | 5 | LPG 5 | 1516 |
| BX 14 | 1.4 | 55 | | TU3M ... | 4 | 0,8 | BCPR5ES | 6130 | 32 | LPG 3 | 1498 |
| BX 15 | 1.5 | 59 | 01.87 - 06.87 | XU5.1C | 4 | 0,8 | BP6EFS | 3812 | 5 | LPG 5 | 1516 |
| BX 15 | 1.5 | 59 | 07.87 - 06.92 | XU5.1C | 4 | 0,8 | BCP5ES | 7496 | 16 | LPG 3 | 1498 |
| BX 16 | 1.6 | 68 | 04.88 - 06.92 | XU5.2C | 4 | 0,7 | BCP6ES | 4930 | 17 | LPG 3 | 1498 |
| BX 16 | 1.6 | | 07.92 - | XU5MZ BDZ Cat. | 4 | 0,8 | BCPR5ES | 6130 | 32 | LPG 3 | 1498 |
| BX 16 16V | 1.6 | | 07.87 - 06.92 | XU9.J4 | 4 | | BCP6ET | 4563 | | LPG 3 | 1498 |
| BX 16 16V | 1.6 | | 07.92 - | XU9.J4 Cat. | 4 | | BCPR6ET | 2197 | | LPG 3 | 1498 |
| BX 16 S, 16RS, 16TRS | | | 07.84 - 03.88 | XU5S 171C | 4 | 0,8 | BP6EFS | 3812 | 5 | LPG 5 | 1516 |
| BX 16i Image, Millésime | | | 07.92 - | XU5M BDY cat. | 4 | 0,8 | BCPR5ES | 6130 | 32 | LPG 3 | 1498 |



ℓ kW

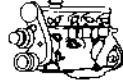

Cyl.

Order-
No.VLINE
No.LPG/CNG
D-PowerOrder-
No.**CITROEN**

| | | | | | | | | | | | |
|----------------------------|-----|----|-------------|-----------------|---|-----|----------|------|----|------------|------|
| BX 17 D | 1.8 | 44 | 07.85-01.93 | XUD 7 | 4 | █ | Y-924J | 7906 | | D-POWER 1 | 7906 |
| BX 17 TD, TRD | 1.8 | 66 | 03.88-01.93 | XUD 7 TE | 4 | █ | Y-924J | 7906 | | D-POWER 1 | 7906 |
| BX 19 | 1.9 | 77 | 07.87-06.89 | XU92C | 4 | 0,8 | BCP5ES | 7496 | 16 | LPG 3 | 1498 |
| BX 19 | 1.9 | 77 | 07.89-06.92 | XU92C | 4 | 0,7 | BCP6ES | 4930 | 17 | LPG 3 | 1498 |
| BX 19 | 1.9 | 77 | 07.87-06.89 | XU92C D2A | 4 | 0,8 | BCP5ES | 7496 | 16 | LPG 3 | 1498 |
| BX 19 | 1.9 | 77 | 09.86-06.87 | XU92C D2A | 4 | 0,8 | BP6EFS | 3812 | 5 | LPG 5 | 1516 |
| BX 19 | 1.9 | 77 | 07.89-06.92 | XU92C D2E | 4 | 0,7 | BCP6ES | 4930 | 17 | LPG 3 | 1498 |
| BX 19 D, RD, TD, TRD | 1.9 | 47 | 09.83-12.87 | XUD 9 | 4 | █ | Y-924J | 7906 | | D-POWER 1 | 7906 |
| BX 19 D, TD, TRD | 1.9 | 51 | 03.87- | XUD 9 A/L | 4 | █ | Y-924J | 7906 | | D-POWER 1 | 7906 |
| BX 19 GT | 1.9 | | 07.84-07.86 | XU9.S 159A | 4 | 0,8 | BP6EFS | 3812 | 5 | LPG 5 | 1516 |
| BX 19i | 1.9 | | 07.92- | XU9.JA DKZ Cat. | 4 | 0,8 | BCPR5ES | 6130 | 32 | LPG 3 | 1498 |
| BX 19i Gti | 1.9 | | 07.88-06.92 | XU9.J2 | 4 | 0,7 | BCP6ES | 4930 | 17 | LPG 3 | 1498 |
| BX 19i Gti 16S | | | 07.87-06.92 | XU9J4 D6C | 4 | | BCP6ET | 4563 | | LPG 3 | 1498 |
| BX 19i Gti 16S | | | 07.92- | XU9J4 DFW cat. | 4 | | BCPR6ET | 2197 | | LPG 3 | 1498 |
| BX 19i Gti, Tri, Tzi / 4x4 | | | 07.86-06.92 | XU9J2 D6A | 4 | 0,7 | BCP6ES | 4930 | 17 | LPG 3 | 1498 |
| BX 4TC | | | | N9TE | 4 | | BP6ET | 1263 | | LPG 2 | 1497 |
| BX Sport | | | 05.85-06.86 | XU9.4 159B | 4 | 0,9 | BU6EFSZ | 3488 | | | |
| C 45 D | 2.5 | 50 | 06.82-01.91 | CRD93B | 4 | █ | Y-208T | 1250 | | | |
| C1 | 1.0 | 50 | 06.05- | | 4 | 1,1 | LFR6C-11 | 5788 | | | |
| C1 Hdi | 1.4 | 40 | 05.06- | DV4 | 4 | █ | YE04 | 1684 | | D-POWER 40 | 1684 |
| C1 Hdi | 1.4 | 50 | 06.05- | DV4TD | 4 | █ | YE05 | 5207 | | | |
| C15 D | 1.8 | 44 | 06.95- | XUD7 | 4 | █ | Y-938R | 5267 | | D-POWER 1 | 7906 |
| C15 D | 1.8 | 44 | 10.84-05.95 | XUD7 | 4 | █ | Y-924J | 7906 | | D-POWER 1 | 7906 |
| C15 D | 1.9 | 44 | 12.00- | DW8 | 4 | █ | Y-503R | 4279 | | D-POWER 10 | 1009 |
| C15 E | 1.0 | 33 | 09.88- | TU9 C1A | 4 | 0,8 | BCP5ES | 7496 | 16 | LPG 3 | 1498 |
| C15 E | 1.0 | | 10.84-09.88 | 108C-109K | 4 | 0,8 | BP6EFS | 3812 | 5 | LPG 5 | 1516 |
| C15 E | 1.1 | 44 | 09.92-06.95 | TU1.M HDZ Cat. | 4 | 0,8 | BCPR5ES | 6130 | 32 | LPG 3 | 1498 |
| C15 E | 1.1 | | 10.87-09.88 | E1A | 4 | 0,7 | BCP6ES | 4930 | 17 | LPG 3 | 1498 |
| C15 E | 1.1 | | 10.88- | TU1 H1A | 4 | 0,8 | BCP5ES | 7496 | 16 | LPG 3 | 1498 |
| C15 E | 1.1 | | 10.84-08.87 | XW7B 109K | 4 | 0,8 | BP6EFS | 3812 | 5 | LPG 5 | 1516 |
| C15 E | 1.3 | 47 | 10.87-09.88 | G1A | 4 | 0,8 | BCP5ES | 7496 | 16 | LPG 3 | 1498 |
| C15 E | 1.4 | | 10.87- | TU3A K1G | 4 | 0,8 | BCP5ES | 7496 | 16 | LPG 3 | 1498 |
| C15 E | 1.4 | | 11.86-09.87 | XY7 150D | 4 | 0,8 | BP6EFS | 3812 | 5 | LPG 5 | 1516 |
| C15 E 1.0 | 1.0 | | 11.86-09.88 | XV8 108C | 4 | 0,8 | BP6EFS | 3812 | 5 | LPG 5 | 1516 |
| C15E | 1.1 | | 07.95- | TU1M HDZ | 4 | | BKR5EK | 7956 | 23 | LPG 1 | 1496 |
| C2 | 1.1 | 45 | 08.03- | TU1JP | 4 | 0,9 | BKR6EZ | 4619 | 38 | LPG 1 | 1496 |
| C2 | 1.4 | 55 | 08.03- | TU3JP | 4 | 0,9 | BKR6EZ | 4619 | 38 | LPG 1 | 1496 |
| C2 16V | 1.6 | 81 | 08.03- | TU5JP4 | 4 | 0,9 | LFR6B | 6677 | | LPG 7 | 1640 |
| C2 16V | 1.6 | 92 | 01.05- | TU5JP4 | 4 | 0,9 | LFR6B | 6677 | | LPG 7 | 1640 |
| C2 Hdi | 1.4 | 51 | 12.04- | DV4TD | 4 | █ | YE05 | 5207 | | | |
| C2 Phase 2 | 1.6 | 80 | 05.08- | DV6TED4 | 4 | █ | YE05 | 5207 | | | |
| C25 | 2.0 | 58 | 09.81-03.94 | XM7T/XN1T/XN1TA | 4 | 0,7 | BP6ES | 7811 | 4 | LPG 2 | 1497 |
| C25 D | 1.9 | 51 | 07.87-01.94 | D9B | 4 | █ | Y-924J | 7906 | | D-POWER 1 | 7906 |
| C25 D | 2.5 | 54 | 07.81-01.94 | CRD93 | 4 | █ | Y-208T | 1250 | | | |
| C25 TD | 2.5 | 70 | 08.87-01.94 | CRD93LS | 4 | █ | Y-208T | 1250 | | | |
| C3 | 1.1 | 44 | 04.02- | TU1A-HFX | 4 | 0,9 | BKR6EZ | 4619 | 38 | LPG 1 | 1496 |
| C3 | 1.1 | 44 | 04.02- | TU1JP-HFZ, HFY | 4 | 0,9 | BKR6EZ | 4619 | 38 | LPG 1 | 1496 |
| C3 | 1.4 | 55 | 04.02- | TU3A-KFV | 4 | 0,9 | BKR6EZ | 4619 | 38 | LPG 1 | 1496 |
| C3 | 1.4 | 66 | 10.03- | ET3J4~KFU | 4 | | LZKAR7A | 6799 | | | |
| C3 | 1.6 | 66 | 10.05- | DV6TED4 | 4 | █ | YE05 | 5207 | | | |
| C3 / Pluriel | 1.4 | 55 | 04.02- | TU3JP-KFX, KFV | 4 | 0,9 | BKR6EZ | 4619 | 38 | LPG 1 | 1496 |
| C3 / Pluriel | 1.6 | 81 | 04.02- | TU5JP4-NFU | 4 | 0,9 | LFR6B | 6677 | | LPG 7 | 1640 |



ℓ kW



Cyl.

Order-
No. No.LPG/CNG
D-PowerOrder-
No.**CITROEN**

| | | | | | | | | | | | |
|--|-----|-----|---------------|------------|---|-----|------------|------|----|------------|------|
| C3 / Pluriel | 1.4 | 55 | 03 - | TU3JP | 4 | 0,9 | BKR6EZ | 4619 | 38 | LPG 1 | 1496 |
| C3 / Pluriel 16V | 1.6 | 81 | 03 - | TU5JP4 | 4 | 0,9 | LFR6B | 6677 | | LPG 7 | 1640 |
| C3 Hdi | 1.4 | 51 | 12.04 - | DV4TD | 4 | █ | YE05 | 5207 | | | |
| C3 Hdi | 1.4 | 52 | 03.02 - 12.04 | DV4TD | 4 | █ | YE04 | 1684 | | D-POWER 40 | 1684 |
| C3 Hdi | 1.4 | 68 | 12.04 - 08.05 | DV4TED4 | 4 | █ | YE05 | 5207 | | | |
| C3 Hdi | 1.6 | 81 | 03.06 - | DV4TED6 | 4 | █ | YE05 | 5207 | | | |
| C3 Hdi 16V | 1.4 | 68 | 03.02 - 12.04 | DV4TED4 | 4 | █ | YE04 | 1684 | | D-POWER 40 | 1684 |
| C3 Picasso 1.4 Vti Attraction, Confort | 1.4 | | 12.08 - | EP3 | 4 | 0,8 | PLZKBR7A-G | 5843 | | PLZKBR7A-G | 5843 |
| C3 Picasso 1.6 Hdi | 1.6 | | 12.08 - | DV6 | 4 | █ | YE05 | 5207 | | | |
| C3 Picasso 1.6 Hdi | 1.6 | | 12.08 - | DV6 | 4 | █ | YE05 | 5207 | | | |
| C3 Picasso 1.6 Vti Confort, Exclusive | 1.6 | | 12.08 - | EP6 | 4 | 0,8 | PLZKBR7A-G | 5843 | | PLZKBR7A-G | 5843 |
| C3 Picasso Hdi | 1.6 | 66 | 12.08 - | DV6ATED4 | 4 | █ | YE05 | 5207 | | | |
| C3 Picasso Hdi | 1.6 | 80 | 12.08 - | DV6TED4 | 4 | █ | YE05 | 5207 | | | |
| C3 X-TR 16V | 1.4 | 68 | 04 - 12.04 | DV4ETD4 | 4 | █ | YE04 | 1684 | | D-POWER 40 | 1684 |
| C35 D | 2.5 | 50 | 01.80 - 01.91 | CRD93B | 4 | █ | Y-208T | 1250 | | | |
| C4 16V | 1.4 | 65 | 11.04 - | ET3J4~KFU | 4 | | LZKAR7A | 6799 | | | |
| C4 16V | 1.6 | 81 | 11.04 - | TU5JP4~NFU | 4 | | LFR6B | 6677 | | LPG 7 | 1640 |
| C4 16V | 2.0 | 100 | 11.04 - | EW10J4~RFN | 4 | | LFR6B | 6677 | | LPG 7 | 1640 |
| C4 16V | 2.0 | 103 | 11.04 - | EW10A | 4 | 0,9 | LFR5B | 7113 | | LPG 7 | 1640 |
| C4 2.0 16V | 2.0 | | 11.04 - | EW10A | 4 | 0,9 | LFR5B | 7113 | | LPG 7 | 1640 |
| C4 Coupé Hdi | 1.6 | 68 | 12.04 - | | 4 | █ | YE04 | 1684 | | D-POWER 40 | 1684 |
| C4 Coupé Hdi | 1.6 | 81 | 12.04 - 06.06 | DV6ETD4 | 4 | █ | YE04 | 1684 | | D-POWER 40 | 1684 |
| C4 Grand Picasso | 1.6 | 81 | 09.06 - | DV6TED4 | 4 | █ | YE05 | 5207 | | | |
| C4 Grand Picasso | 2.0 | 102 | 09.06 - | DW10TD | 4 | █ | Y-504R | 4359 | | D-POWER 24 | 1441 |
| C4 Grand Picasso | 2.0 | 105 | 09.06 - | EW10A | 4 | 0,9 | LFR5B | 7113 | | LPG 7 | 1640 |
| C4 Grand Picasso | 2.0 | 110 | 06.09 - | DW10CTED4 | 4 | █ | Y8001AS | 8904 | | D-POWER 58 | 8904 |
| C4 Grand Picasso | 2.0 | 100 | 02.07 - | DW10BTED4 | 4 | █ | Y1005J | 7957 | | D-POWER 56 | 7957 |
| C4 Grand Picasso 1.8i 16V | 1.8 | | 09.06 - | EW7A | 4 | 0,9 | LFR5B | 7113 | | LPG 7 | 1640 |
| C4 Grand Picasso 2.0 16V | 2.0 | | 09.06 - | EW10A | 4 | 0,9 | LFR5B | 7113 | | LPG 7 | 1640 |
| C4 Hdi | 2.0 | 100 | 09.04 - | DW10BTED4 | 4 | █ | Y1005J | 7957 | | D-POWER 56 | 7957 |
| C4 Hdi | 2.0 | 103 | 07.08 - | DW10BTED4 | 4 | █ | Y1005J | 7957 | | D-POWER 56 | 7957 |
| C4 Hdi / Picasso | 1.6 | 81 | 03.07 - | DV6TED | 4 | █ | YE05 | 5207 | | | |
| C4 Picasso | 1.6 | 81 | 02.07 - | DV6TED4 | 4 | █ | YE05 | 5207 | | | |
| C4 Picasso | 2.0 | 102 | 02.07 - | DW10TD | 4 | █ | Y-504R | 4359 | | D-POWER 24 | 1441 |
| C4 Picasso | 2.0 | 105 | 02.07 - | EW10A | 4 | 0,9 | LFR5B | 7113 | | LPG 7 | 1640 |
| C4 Picasso | 2.0 | 110 | 06.09 - | DW10CTED4 | 4 | █ | Y8001AS | 8904 | | D-POWER 58 | 8904 |
| C4 Picasso | 2.0 | 100 | 10.06 - | DW10BTED4 | 4 | █ | Y1005J | 7957 | | D-POWER 56 | 7957 |
| C4 Picasso 1.8i 16V | 1.8 | | 02.07 - | EW7A | 4 | 0,9 | LFR5B | 7113 | | LPG 7 | 1640 |
| C4 Picasso 2.0 16V | 2.0 | | 02.07 - | EW10A | 4 | 0,9 | LFR5B | 7113 | | LPG 7 | 1640 |
| C5 | 1.8 | 86 | 06.02 - | EW7J4 6FZ | 4 | 0,9 | LFR5B | 7113 | | LPG 7 | 1640 |
| C5 | 2.0 | 100 | 10.00 - | EW10J4-RFN | 4 | 0,9 | LFR5B | 7113 | | LPG 7 | 1640 |
| C5 | 2.0 | 105 | 09.04 - | EW10A | 4 | 0,9 | LFR5B | 7113 | | LPG 7 | 1640 |
| C5 | 3.0 | 154 | 10.00 - | ES9J4S XFX | 6 | 1,1 | PLFR5A-11 | 6240 | | LPG 7 | 1640 |
| C5 2.0 16V | 2.0 | | 09.04 - | EW10A | 4 | 0,9 | LFR5B | 7113 | | LPG 7 | 1640 |
| C5 Hdi | 1.6 | 81 | 03.06 - | DV6 | 4 | █ | YE05 | 5207 | | | |
| C5 Hdi | 2.0 | 66 | 06.02 - | DW10ATD | 4 | █ | Y-504R | 4359 | | D-POWER 24 | 1441 |
| C5 Hdi | 2.0 | 81 | 02.01 - | DW10ATED | 4 | █ | Y-504R | 4359 | | D-POWER 24 | 1441 |
| C5 Hdi | 2.0 | 100 | 09.04 - | DW10BTED4 | 4 | █ | Y1005J | 7957 | | D-POWER 56 | 7957 |
| C5 Hdi | 2.2 | 125 | 05.06 - | DW12BTED4 | 4 | █ | YE08 | 4966 | | | |
| C5 Hdi | 2.2 | 100 | 10.00 - 08.04 | DW12TED4 | 4 | █ | Y1005J | 7957 | | D-POWER 56 | 7957 |
| C5 Hdi | 2.2 | 98 | 09.04 - 08.05 | DW12TED4 | 4 | █ | Y1005J | 7957 | | D-POWER 56 | 7957 |
| C5 Hdi 16V | 2.2 | 100 | 02.01 - | DW12TED4 | 4 | █ | Y-504R | 4359 | | D-POWER 24 | 1441 |



ℓ kW

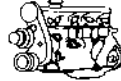

Cyl.

Order-
No.VLINE
No.LPG/CNG
D-PowerOrder-
No.**CITROEN**

| | | | | | | | | | | | |
|---------------------------|-----|-----|--------------|-----------------|---|-----|-----------|------|----|------------|------|
| C5 Phase 2 Hdi 16 V | 1.6 | 80 | 04.08 - | DV6TED4 | 4 | █ | YE05 | 5207 | | | |
| C5 Phase 2 Hdi 16 V | 2.2 | 126 | 04.08 - | DW12BTED4 | 4 | █ | YE08 | 4966 | | | |
| C6 Hdi | 2.2 | 125 | 11.06 - | DW12BTED4 | 4 | █ | YE08 | 4966 | | | |
| C6 Hdi | 2.7 | 150 | 12.05 - | DT17 | 6 | █ | YE12 | 7794 | | | |
| C8 | 2.0 | 102 | 06.02 - | EW10J4-RFN | 4 | 0,9 | LFR5B | 7113 | | LPG 7 | 1640 |
| C8 | 2.0 | 104 | 09.05 - | EW10A | 4 | 0,9 | LFR5B | 7113 | | LPG 7 | 1640 |
| C8 | 2.2 | 118 | 06.02 - | EW12J4-3FZ | 4 | 0,9 | LFR5B | 7113 | | LPG 7 | 1640 |
| C8 2.0 16V | 2.0 | | 09.05 - | EW10A | 4 | 0,9 | LFR5B | 7113 | | LPG 7 | 1640 |
| C8 Hdi | 2.0 | 100 | 03.06 - | DW10BTED4 | 4 | █ | Y1005J | 7957 | | D-POWER 56 | 7957 |
| C8 Hdi | 2.0 | 79 | 04.02 -08.07 | DW10ATED4 | 4 | █ | Y1005J | 7957 | | D-POWER 56 | 7957 |
| C8 Hdi | 2.0 | 80 | 10.02 -02.07 | DW10UTED4 | 4 | █ | Y1005J | 7957 | | D-POWER 56 | 7957 |
| C8 Hdi | 2.0 | 81 | 04.02 - | DW10ATED4 | 4 | █ | Y1005J | 7957 | | D-POWER 56 | 7957 |
| C8 Hdi | 2.0 | 88 | 03.07 - | DW10UTED4 | 4 | █ | Y1005J | 7957 | | D-POWER 56 | 7957 |
| C8 Hdi | 2.2 | 96 | 02 - | DW12 | 4 | █ | Y-504R | 4359 | | D-POWER 24 | 1441 |
| C8 Hdi | 2.2 | 94 | 04.02 -07.06 | DW12TED4 | 4 | █ | Y1005J | 7957 | | D-POWER 56 | 7957 |
| C8 Hdi 16V | 2.0 | 80 | 07.02 - | DW10TED4/RHT | 4 | █ | Y-504R | 4359 | | D-POWER 24 | 1441 |
| C8 V6 | 3.0 | 150 | 10.02 - | ES9J4S | 6 | 1,1 | PLFR5A-11 | 6240 | | LPG 7 | 1640 |
| C-Crosser Hdi | 2.2 | 115 | 06.07 - | DW12MTED4 | 4 | █ | YE08 | 4966 | | | |
| CX 25 | 2.5 | 54 | 07.82 -12.92 | M25 660 | 4 | █ | Y-924J | 7906 | | D-POWER 1 | 7906 |
| CX 25 D | 2.5 | 54 | 07.82 -06.88 | M25 660 | 4 | █ | Y-208T | 1250 | | | |
| CX 25 TD Turbo 2 | 2.5 | 78 | 01.87 -12.92 | M25 669/671 | 4 | █ | Y-208T | 1250 | | | |
| CX 25 Turbo | 2.5 | | 04.83 -12.86 | M25 648 | 4 | █ | Y-208T | 1250 | | | |
| Dispatch | 1.9 | | 09.98 - | DW8, DW8TD | 4 | █ | Y-503R | 4279 | | D-POWER 10 | 1009 |
| Dispatch | 1.9 | | 09.96 -07.98 | XUD9A, XUD9TF | 4 | █ | Y-923U | 3380 | | D-POWER 1 | 7906 |
| Dispatch | 1.9 | | 09.98 - | XUD9A, XUD9TF | 4 | █ | Y-938R | 5267 | | D-POWER 1 | 7906 |
| Dispatch | 2.0 | | 03.00 - | DW10 | 4 | █ | Y-504R | 4359 | | D-POWER 24 | 1441 |
| Evasion | 1.8 | 72 | 09.96 -06.00 | XU7JP LFW | 4 | | BKR5EK | 7956 | 23 | LPG 1 | 1496 |
| Evasion | 1.9 | 68 | 09.98 -09.02 | XUD9TF, XUD9BTF | 4 | █ | Y-938R | 5267 | | D-POWER 1 | 7906 |
| Evasion | 2.0 | 89 | 07.94 -03.95 | XU10J2 RFU | 4 | 0,8 | BCPR5ES | 6130 | 32 | LPG 3 | 1498 |
| Evasion | 2.0 | 90 | 04.95 -05.00 | XU10J2 RFU | 4 | | BKR5EK | 7956 | 23 | LPG 1 | 1496 |
| Evasion | 2.0 | 101 | 06.00 - | EW10J4-RFR | 4 | 0,9 | LFR5B | 7113 | | LPG 7 | 1640 |
| Evasion | 2.0 | 110 | | XU10J2 CTE | 4 | | BKR6EK | 2288 | 20 | LPG 1 | 1496 |
| Evasion Hdi | 2.0 | 81 | 09.98 -09.02 | DW10ATED | 4 | █ | Y-504R | 4359 | | D-POWER 24 | 1441 |
| Evasion TD | 1.9 | 66 | 03.94 -08.98 | XUD9TF | 4 | █ | Y-923U | 3380 | | D-POWER 1 | 7906 |
| Evasion TD | 2.1 | 80 | 05.96 -04.97 | XUD11BTE | 4 | █ | Y-924J | 7906 | | D-POWER 1 | 7906 |
| Evasion TD | 2.1 | 80 | 05.97 -12.98 | XUD11BTE | 4 | █ | Y-924J | 7906 | | D-POWER 1 | 7906 |
| Evasion Turbo | 2.0 | 110 | 09.94 -05.00 | XU10J2TE RGX | 4 | | BKR6EK | 2288 | 20 | LPG 1 | 1496 |
| GSA | | | -07.86 | | 4 | 0,7 | BP6ES | 7811 | 4 | LPG 2 | 1497 |
| GSA 1100, GSA 1300, GSX 3 | | | | | 4 | 0,7 | BP6ES | 7811 | 4 | LPG 2 | 1497 |
| GSA A/D/DK | | | -07.86 | | 4 | 0,8 | BP6EFS | 3812 | 5 | LPG 5 | 1516 |
| Jumper | 1.9 | 52 | 06.95 - | XUD9AU | 4 | █ | Y-938R | 5267 | | D-POWER 1 | 7906 |
| Jumper | 1.9 | 68 | 09.98 - | XUD9TF | 4 | █ | Y-938R | 5267 | | D-POWER 1 | 7906 |
| Jumper | 2.0 | 81 | -03.95 | XU10.J2U RFW | 4 | 0,8 | BCPR6ES | 2330 | 12 | LPG 3 | 1498 |
| Jumper | 2.0 | 81 | 04.95 - | XU10.J2U RFW | 4 | | BKR6EK | 2288 | 20 | LPG 1 | 1496 |
| Jumper | 2.2 | 74 | 02.02 -06.06 | DW12UTED | 4 | █ | Y1005J | 7957 | | D-POWER 56 | 7957 |
| Jumper D | 1.9 | 52 | 03.94 -05.95 | XUD9AU | 4 | █ | Y-923U | 3380 | | D-POWER 1 | 7906 |
| Jumper D | 2.5 | 63 | 03.94 - | DJ5 | 4 | █ | Y-923U | 3380 | | D-POWER 1 | 7906 |
| Jumper Hdi | 2.0 | 66 | 09.98 - | DW10TD | 4 | █ | Y-504R | 4359 | | D-POWER 24 | 1441 |
| Jumper Hdi | 2.2 | 74 | 04.02 - | DW12TED | 4 | █ | Y-504R | 4359 | | D-POWER 24 | 1441 |
| Jumper Hdi | 2.2 | 76 | 09.98 - | DW10TED4 | 4 | █ | Y-504R | 4359 | | D-POWER 24 | 1441 |
| Jumper Hdi | 2.2 | 100 | 09.98 - | DW12TED4 | 4 | █ | Y-504R | 4359 | | D-POWER 24 | 1441 |
| Jumper Hdi | 2.8 | 93 | 09.00 -04.02 | 4HY | 4 | █ | Y-502R | 3852 | | | |



ℓ kW



Cyl.

Order-
No. No.LPG/CNG
D-PowerOrder-
No.**CITROEN**

| | | | | | | | | | | |
|--------------------------|-----|-----|---------------|---------------------|---|------------|------|----|------------|------|
| Jumper TD | 1.9 | 68 | 03.94 - 08.98 | XUD9TF | 4 | Y-923U | 3380 | | D-POWER 1 | 7906 |
| Jumper TD | 2.5 | 76 | 03.94 - 08.96 | DJ5T | 4 | Y-923U | 3380 | | D-POWER 1 | 7906 |
| Jumper Tdi | 2.5 | 78 | 09.96 - | DJ5TED | 4 | Y-738U | 5390 | | | |
| Jumpy | 1.6 | 59 | 10.95 - | 1580 SPI 220.A2.000 | 4 | 0,8 BCP7E5 | 3330 | | BCP7EIX | 5690 |
| Jumpy | 2.0 | 102 | 06.01 - | EW10J4-RFN | 4 | 0,9 LFR5B | 7113 | | LPG 7 | 1640 |
| Jumpy Hdi | 2.0 | 70 | 02.00 - | DW10TED | 4 | Y-504R | 4359 | | D-POWER 24 | 1441 |
| Jumpy Hdi | 2.0 | 81 | 02.00 - | DW10ATED | 4 | Y-504R | 4359 | | D-POWER 24 | 1441 |
| Jumpy Hdi | 2.0 | 100 | 11.06 - | DW10BTED4 | 4 | Y1005J | 7957 | | D-POWER 56 | 7957 |
| Jumpy Hdi | 2.0 | 81 | 05.02 - 10.06 | DW10ATED4 | 4 | Y1005J | 7957 | | D-POWER 56 | 7957 |
| Jumpy Hdi | 2.0 | 88 | 11.06 - | DW10UTED4 | 4 | Y1005J | 7957 | | D-POWER 56 | 7957 |
| Jumpy 16V | 2.0 | 105 | 12.06 - | EW10A | 4 | 0,9 LFR5B | 7113 | | LPG 7 | 1640 |
| Jumpy D | 1.8 | 51 | 09.98 - | DW8 | 4 | Y-503R | 4279 | | D-POWER 10 | 1009 |
| Jumpy D | 1.9 | 51 | 09.98 - | DW8 | 4 | Y-503R | 4279 | | D-POWER 10 | 1009 |
| Jumpy D | 1.9 | 51 | 01.96 - 08.98 | XUD9A | 4 | Y-923U | 3380 | | D-POWER 1 | 7906 |
| Jumpy D | 1.9 | 51 | 09.98 - | XUD9A | 4 | Y-938R | 5267 | | D-POWER 1 | 7906 |
| Jumpy Hdi | 1.6 | 66 | 02.07 - | DV6 | 4 | YE05 | 5207 | | | |
| Jumpy Hdi | 2.0 | 70 | 02.00 - | DW10TED | 4 | Y-504R | 4359 | | D-POWER 24 | 1441 |
| Jumpy Hdi | 2.0 | 81 | 02.00 - | DW10ATED | 4 | Y-504R | 4359 | | D-POWER 24 | 1441 |
| Jumpy Hdi | 2.0 | 90 | 02.07 - | | 4 | YE05 | 5207 | | | |
| Jumpy Hdi | 2.0 | 102 | 02.07 - | | 4 | YE05 | 5207 | | | |
| Jumpy TD | 1.9 | 68 | 01.96 - 08.98 | XUD9TF/BTF | 4 | Y-923U | 3380 | | D-POWER 1 | 7906 |
| Jumpy TD | 1.9 | 68 | 09.96 - | XUD9TF/BTF | 4 | Y-938R | 5267 | | D-POWER 1 | 7906 |
| LNA | 0.6 | | | V06/6 | 2 | 0,8 BP6EFS | 3812 | 5 | LPG 5 | 1516 |
| LNA | 0.6 | | | XW7 / XV8 | 2 | 0,8 BP6EFS | 3812 | 5 | LPG 5 | 1516 |
| LNA / 11E / 11RE / 14TRS | 0.6 | | -06.86 | | 2 | 0,8 BP6EFS | 3812 | 5 | LPG 5 | 1516 |
| Némo Hdi | | 51 | 02.08 - | DV4 | 4 | YE05 | 5207 | | | |
| Relay | 1.9 | | 09.98 - | XUD9TF | 4 | Y-938R | 5267 | | D-POWER 1 | 7906 |
| Relay | 1.9 | | 03.94 - 08.98 | XUD9TF, 9AU | 4 | Y-923U | 3380 | | D-POWER 1 | 7906 |
| Relay | 2.0 | | 09.98 - | DW10TED/DU | 4 | Y-504R | 4359 | | D-POWER 24 | 1441 |
| Relay | 2.5 | | 03.94 - | DJ5, DJ5T | 4 | Y-923U | 3380 | | D-POWER 1 | 7906 |
| Relay | 2.5 | | 09.96 - | DJ5TED 12V | 4 | Y-738U | 5390 | | | |
| Saxo 1 | 1.0 | 37 | 02.96 - 09.99 | TU9M CDZ | 4 | BKR5EK | 7956 | 23 | LPG 1 | 1496 |
| Saxo 1 | 1.1 | 44 | 02.96 - 08.99 | TU1M+ HDZ | 4 | BKR6EK | 2288 | 20 | LPG 1 | 1496 |
| Saxo 1 | 1.4 | 55 | 02.96 - 08.99 | TU3JP KFW | 4 | BKR6EK | 2288 | 20 | LPG 1 | 1496 |
| Saxo 1 | 1.4 | 55 | 02.96 - 08.99 | TU3JP+ KFX | 4 | BKR6EK | 2288 | 20 | LPG 1 | 1496 |
| Saxo 1 | 1.5 | 43 | 05.96 - 08.99 | TUD 5 | 4 | Y-503J | 1009 | | D-POWER 10 | 1009 |
| Saxo 1 | 1.6 | 66 | 07.98 - 08.99 | TU5JP+ NFZ | 4 | BKR6EK | 2288 | 20 | LPG 1 | 1496 |
| Saxo 2 | 1.0 | 37 | 09.99 - 12.00 | TU9M CDZ | 4 | BKR5EK | 7956 | 23 | LPG 1 | 1496 |
| Saxo 2 | 1.1 | 44 | 06.00 - | TU1JP HFX | 4 | 0,9 BKR6EZ | 4619 | 38 | LPG 1 | 1496 |
| Saxo 2 | 1.1 | 44 | 06.00 - | TU1JP HFX | 4 | 0,9 BKR6EZ | 4619 | 38 | LPG 1 | 1496 |
| Saxo 2 | 1.1 | 44 | 09.99 - | TU1M+ HDZ | 4 | BKR6EK | 2288 | 20 | LPG 1 | 1496 |
| Saxo 2 | 1.4 | 55 | 09.99 - | TU3JP KFW | 4 | 0,9 BKR6EZ | 4619 | 38 | LPG 1 | 1496 |
| Saxo 2 | 1.4 | 55 | 09.99 - | TU3JP+ KFX | 4 | 0,9 BKR6EZ | 4619 | 38 | LPG 1 | 1496 |
| Saxo 2 | 1.5 | 43 | 09.99 - 05.03 | TUD 5 | 4 | Y-503J | 1009 | | D-POWER 10 | 1009 |
| Saxo 2 | 1.6 | 66 | 01.01 - | TU5JP NFT | 4 | 0,9 BKR6EZ | 4619 | 38 | LPG 1 | 1496 |
| Saxo 2 | 1.6 | 66 | 09.99 - 12.00 | TU5JP+ NFZ | 4 | 0,9 BKR6EZ | 4619 | 38 | LPG 1 | 1496 |
| Saxo 2 | 1.6 | 88 | 03.01 - 04.02 | TU5JP NFX | 4 | BKR6EK | 2288 | 20 | LPG 1 | 1496 |
| Synergie | 1.9 | | 10.95 - 08.98 | XUD9BTF/L3 | 4 | Y-923U | 3380 | | D-POWER 1 | 7906 |
| Synergie | 1.9 | | 09.98 - 10.00 | XUD9TF, XUD9BTF | 4 | Y-938R | 5267 | | D-POWER 1 | 7906 |
| Synergie | 2.0 | | 08.99 - | DW10TED | 4 | Y-504R | 4359 | | D-POWER 24 | 1441 |
| Visa | 0.6 | | -03.91 | V06/... | 4 | 0,8 BP6EFS | 3812 | 5 | LPG 5 | 1516 |
| Visa 10 | | | -03.91 | | 4 | 0,8 BP6EFS | 3812 | 5 | LPG 5 | 1516 |



ℓ kW

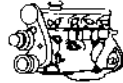

Cyl.

Order-
No.VLINE
No.LPG/CNG
D-PowerOrder-
No.**CITROEN**

| | | | | | | | | | | | |
|----------------------|-----|-----|-------------|------------------|---|-----|---------|------|----|------------|------|
| Visa 10 | | | | XV8 | 4 | 0,8 | BP6EFS | 3812 | 5 | LPG 5 | 1516 |
| Visa 11 | | | | XW7 | 4 | 0,8 | BP6EFS | 3812 | 5 | LPG 5 | 1516 |
| Visa 14 | | | | XY7 | 4 | 0,8 | BP6EFS | 3812 | 5 | LPG 5 | 1516 |
| Visa 14TRS | 1.4 | | -03.91 | 150D Cat. | 4 | 0,8 | BP6EFS | 3812 | 5 | LPG 5 | 1516 |
| Visa 17 D | 1.8 | 44 | 04.84-03.91 | 161A | 4 | █ | Y-924J | 7906 | | D-POWER 1 | 7906 |
| Visa Chrono | | | | XYR | 4 | 0,6 | BR7EF | 3346 | | | |
| Visa Club | 0.6 | | -03.91 | | 4 | 0,6 | BP7EFS | 3526 | | | |
| Visa GT | | | | XY8 | 4 | 0,8 | BP6EFS | 3812 | 5 | LPG 5 | 1516 |
| Visa GT / GTi | | | -06.87 | XU5.J/JA | 4 | 0,6 | BP7EFS | 3526 | | | |
| Visa GTi | | 85 | 07.87- | XU5.JA | 4 | 0,7 | BCP6ES | 4930 | 17 | LPG 3 | 1498 |
| Visa Special / Super | | | -03.91 | | 4 | 0,8 | BP6EFS | 3812 | 5 | LPG 5 | 1516 |
| Xantia | 1.6 | 66 | 06.93-05.95 | XU5JP BFZ | 4 | 0,8 | BCPR5ES | 6130 | 32 | LPG 3 | 1498 |
| Xantia | 1.6 | 66 | 06.95- | XU5JP BFZ | 4 | | BKR5EK | 7956 | 23 | LPG 1 | 1496 |
| Xantia | 1.8 | 66 | 01.98- | XU7JB LFX | 4 | | BKR6EK | 2288 | 20 | LPG 1 | 1496 |
| Xantia | 1.8 | 76 | 04.95- | XU7JP LFZ | 4 | | BKR5EK | 7956 | 23 | LPG 1 | 1496 |
| Xantia | 1.8 | 76 | 07.93-03.95 | XU7JP LFZ | 4 | 0,8 | BCPR5ES | 6130 | 32 | LPG 3 | 1498 |
| Xantia | 1.9 | 55 | 05.94- | XUD9A | 4 | █ | Y-938R | 5267 | | D-POWER 1 | 7906 |
| Xantia | 1.9 | 55 | 09.98- | XUD9A/L | 4 | █ | Y-938R | 5267 | | D-POWER 1 | 7906 |
| Xantia | 1.9 | 68 | 09.98-12.00 | XUD9BTF, XUD9BSD | 4 | █ | Y-938R | 5267 | | D-POWER 1 | 7906 |
| Xantia | 2.0 | 90 | 03.93-05.95 | XU10J2 RFX | 4 | 0,8 | BCPR5ES | 6130 | 32 | LPG 3 | 1498 |
| Xantia | 2.0 | 90 | 06.95- | XU10J2 RFX | 4 | | BKR5EK | 7956 | 23 | LPG 1 | 1496 |
| Xantia | 2.1 | 80 | 09.98- | XUD11BTF | 4 | █ | Y-938R | 5267 | | D-POWER 1 | 7906 |
| Xantia | 3.0 | 142 | 03.97- | ES9J4 XFZ | 6 | | BKR6EK | 2288 | 20 | LPG 1 | 1496 |
| Xantia turbo | 2.0 | 110 | 07.96- | XU10J2TE RGX | 4 | | BKR6EK | 2288 | 20 | LPG 1 | 1496 |
| Xantia D | 1.9 | 51 | 03.93-01.96 | XUD 9 A/L | 4 | █ | Y-924J | 7906 | | D-POWER 1 | 7906 |
| Xantia Hdi | 2.0 | 66 | 10.98- | DW10TD | 4 | █ | Y-504R | 4359 | | D-POWER 24 | 1441 |
| Xantia Hdi | 2.0 | 81 | 10.98-12.01 | DW10ATED | 4 | █ | Y-504R | 4359 | | D-POWER 24 | 1441 |
| Xantia 16V | 1.8 | 82 | 07.95- | XU7JP4 LFY | 4 | | BKR5EK | 7956 | 23 | LPG 1 | 1496 |
| Xantia 16V | 2.0 | 99 | 06.95- | XU10J4R RFV | 4 | | BKR5EK | 7956 | 23 | LPG 1 | 1496 |
| Xantia 16V | 2.0 | 112 | 93- | XU10J4D | 4 | 0,8 | BKR6ES | 3783 | 28 | LPG 1 | 1496 |
| Xantia TD | 1.9 | 68 | 06.93-08.98 | XUD9TF | 4 | █ | Y-923U | 3380 | | D-POWER 1 | 7906 |
| Xantia TD | 2.1 | 80 | 06.95-08.98 | XUD11BTE | 4 | █ | Y-923U | 3380 | | D-POWER 1 | 7906 |
| Xantia TDX | 1.9 | 55 | | XUD9SD | 4 | █ | Y-923U | 3380 | | D-POWER 1 | 7906 |
| XM | 2.0 | 99 | 07.94-12.00 | XU10J4R RFV | 4 | | BKR5EK | 7956 | 23 | LPG 1 | 1496 |
| XM | 2.0 | 110 | 96- | XU10J2CTE | 4 | | BKR6EK | 2288 | 20 | LPG 1 | 1496 |
| XM | 2.0 | | 05.89-12.92 | XU102C-R2A | 4 | 0,7 | BCP6ES | 4930 | 17 | LPG 3 | 1498 |
| XM | 2.0 | | 05.89-12.92 | XU10J2 R6A | 4 | 0,8 | BCPR6ES | 2330 | 12 | LPG 3 | 1498 |
| XM | 2.0 | | 05.92-12.00 | XU10J2 RFZ Cat. | 4 | 0,8 | BCPR5ES | 6130 | 32 | LPG 3 | 1498 |
| XM | 2.1 | 80 | 09.98-12.00 | XUD11ATE/L/BTE | 4 | █ | Y-938R | 5267 | | D-POWER 1 | 7906 |
| XM | 3.0 | | 05.89-06.94 | ZPJ-SFZ | 6 | | BCPR6ET | 2197 | | LPG 3 | 1498 |
| XM | 3.0 | | 07.94-06.97 | ZPJ-UFZ | 6 | | BCPR6ET | 2197 | | LPG 3 | 1498 |
| XM V6 24V | 3.0 | 140 | 01.97-12.00 | ES9J4-XFZ | 6 | | BKR6EK | 2288 | 20 | LPG 1 | 1496 |
| XM V6 24V | 3.0 | | 07.94-07.97 | ZPJ4-UKZ | 6 | | BCPR7ET | 2164 | | BCPR7EIX | 5690 |
| XM 16V | 2.0 | | 07.94- | | 4 | 0,8 | BCPR6ES | 2330 | 12 | LPG 3 | 1498 |
| XM D 12 D | 2.1 | 60 | 05.89-06.94 | XUD11A/L | 4 | █ | Y-924J | 7906 | | D-POWER 1 | 7906 |
| XM D 12 TD | 2.1 | 80 | 05.89-08.98 | XUD11ATE/L/BTE | 4 | █ | Y-923U | 3380 | | D-POWER 1 | 7906 |
| XM TD | 2.5 | 96 | 07.94-12.00 | DK5ATE | 4 | █ | Y-923U | 3380 | | D-POWER 1 | 7906 |
| XM Turbo | 2.0 | 110 | 11.92-12.00 | XU10J2TE RGX | 4 | | BKR6EK | 2288 | 20 | LPG 1 | 1496 |
| Xsara | 1.4 | 55 | 09.97-08.00 | TU3JP KFX | 4 | | BKR6EK | 2288 | 20 | LPG 1 | 1496 |
| Xsara | 1.5 | 43 | 09.97-08.00 | TUD5 | 4 | █ | Y-503J | 1009 | | D-POWER 10 | 1009 |
| Xsara | 1.6 | 66 | 09.97-08.00 | TU5JP NFZ | 4 | | BKR6EK | 2288 | 20 | LPG 1 | 1496 |
| Xsara | 1.8 | 43 | 10.97-09.00 | XUD7 | 4 | █ | Y-938R | 5267 | | D-POWER 1 | 7906 |



ℓ kW



Cyl.

Order-
No. No.LPG/CNG
D-PowerOrder-
No.**CITROEN**

| | | | | | | | | | | | |
|------------------------|-----|-----|---------------|----------------|---|-----|---------|------|----|------------|------|
| Xsara | 1.8 | 66 | 09.97 - 08.00 | XU7JB LFX | 4 | | BKR6EK | 2288 | 20 | LPG 1 | 1496 |
| Xsara | 1.9 | 50 | 09.97 - 09.00 | XUD9A DJY | 4 | ■ | Y-938R | 5267 | | D-POWER 1 | 7906 |
| Xsara | 1.9 | 51 | 06.99 - 08.00 | DW8 | 4 | ■ | Y-503R | 4279 | | D-POWER 10 | 1009 |
| Xsara Hdi | 2.0 | 66 | 04.99 - 08.00 | DW10TD | 4 | ■ | Y-504R | 4359 | | D-POWER 24 | 1441 |
| Xsara TD | 1.9 | 66 | 10.97 - 09.00 | XUD9TE DHY | 4 | ■ | Y-938R | 5267 | | D-POWER 1 | 7906 |
| Xsara 16V | 1.8 | 75 | 09.97 - 08.00 | XU7JP LFZ | 4 | | BKR5EK | 7956 | 23 | LPG 1 | 1496 |
| Xsara 16V | 1.8 | 82 | 09.97 - 08.00 | XU7JP4 LFY | 4 | | BKR5EK | 7956 | 23 | LPG 1 | 1496 |
| Xsara 16V | 2.0 | 120 | 09.97 - 08.00 | XU10J4RS RFS | 4 | | BKR6EK | 2288 | 20 | LPG 1 | 1496 |
| Xsara 2 | 1.4 | 55 | 09.00 - | TU3JP KFW | 4 | 0,9 | BKR6EZ | 4619 | 38 | LPG 1 | 1496 |
| Xsara 2 | 1.5 | 43 | 09.00 - | TUD5 | 4 | ■ | Y-503J | 1009 | | D-POWER 10 | 1009 |
| Xsara 2 | 1.9 | 52 | 09.00 - | DW8 WJZ | 4 | ■ | Y-503R | 4279 | | D-POWER 10 | 1009 |
| Xsara 2 2.0i 16V VTS | 2.0 | 123 | 09.00 - | XU10J4RS RFS | 4 | 0,9 | BKR5EZ | 7642 | 36 | LPG 1 | 1496 |
| Xsara 2 Hdi | 2.0 | 66 | 09.00 - 12.02 | DW10TD RHY | 4 | ■ | Y-504R | 4359 | | D-POWER 24 | 1441 |
| Xsara 2 Hdi | 2.0 | 81 | 05.01 - | DW10ATED RHZ | 4 | ■ | Y-504R | 4359 | | D-POWER 24 | 1441 |
| Xsara 2 16V | 1.6 | 81 | 09.00 - | TU5JP4-NFU | 4 | 0,9 | LFR6B | 6677 | | LPG 7 | 1640 |
| Xsara 2 16V | 1.8 | 86 | 09.00 - | EW7J4 6FZ | 4 | 0,9 | LFR5B | 7113 | | LPG 7 | 1640 |
| Xsara 2 16V | 2.0 | 101 | 09.00 - | EW10J4-RFN | 4 | 0,9 | LFR5B | 7113 | | LPG 7 | 1640 |
| Xsara 2 Hdi | 1.4 | 51 | 02.03 - 12.04 | DV4TD | 4 | ■ | YE04 | 1684 | | D-POWER 40 | 1684 |
| Xsara 2 Hdi | 1.4 | 51 | 12.04 - | DV4TD | 4 | ■ | YE05 | 5207 | | | |
| Xsara Picasso | 1.6 | 66 | 12.99 - | TU5JP NFZ, NFV | 4 | 0,9 | BKR6EZ | 4619 | 38 | LPG 1 | 1496 |
| Xsara Picasso | 2.0 | 101 | 09.00 - | EW10J4-RFM | 4 | 0,9 | LFR5B | 7113 | | LPG 7 | 1640 |
| Xsara Picasso 1.8i 16V | 1.8 | 86 | 12.99 - | EW7J4-6FZ | 4 | 0,9 | LFR5B | 7113 | | LPG 7 | 1640 |
| Xsara Picasso Hdi | 1.6 | 81 | 05.04 - 06.06 | DV6 | 4 | ■ | YE04 | 1684 | | D-POWER 40 | 1684 |
| Xsara Picasso Hdi | 2.0 | 66 | 01.00 - 07 | DW10TD | 4 | ■ | Y-504R | 4359 | | D-POWER 24 | 1441 |
| Xsara Picasso Hdi | 2.0 | 81 | 01.00 - 07 | DW10TD | 4 | ■ | Y-504R | 4359 | | D-POWER 24 | 1441 |
| ZX 1.8 Reflex D | 1.8 | 44 | 03.91 - | XUD 7 A9A | 4 | ■ | Y-924J | 7906 | | D-POWER 1 | 7906 |
| ZX 1.0 | 1.0 | 44 | | TU1M | 4 | | BKR5EK | 7956 | 23 | LPG 1 | 1496 |
| ZX 1.1 | 1.1 | 40 | 03.91 - 06.92 | TU1 | 4 | 0,8 | BCP5ES | 7496 | 16 | LPG 3 | 1498 |
| ZX 1.1 | 1.1 | 44 | 04.96 - | TU1M | 4 | | BKR5EK | 7956 | 23 | LPG 1 | 1496 |
| ZX 1.1 | 1.1 | 44 | 07.92 - 03.96 | TU1M HDZ | 4 | 0,8 | BCPR5ES | 6130 | 32 | LPG 3 | 1498 |
| ZX 1.1i | 1.1 | 44 | 04.96 - | TU1M HDZ | 4 | | BKR5EK | 7956 | 23 | LPG 1 | 1496 |
| ZX 1.4 | 1.4 | 55 | 03.91 - 12.92 | TU32 K2C | 4 | 0,8 | BCP5ES | 7496 | 16 | LPG 3 | 1498 |
| ZX 1.4 | 1.4 | 55 | 07.97 - | TU3JP KFX | 4 | | BKR6EK | 2288 | 20 | LPG 1 | 1496 |
| ZX 1.4 | 1.4 | 55 | 07.97 - | TU3JP-KFX | 4 | | BKR6EK | 2288 | 20 | LPG 1 | 1496 |
| ZX 1.4 | 1.4 | 55 | 03.91 - 06.97 | TU3MC KDX | 4 | 0,8 | BCPR6ES | 2330 | 12 | LPG 3 | 1498 |
| ZX 1.4 | 1.4 | 55 | 07.92 - 06.97 | TU3MC KDY Cat. | 4 | | BKR6EK | 2288 | 20 | LPG 1 | 1496 |
| ZX 1.6 | 1.6 | 65 | 03.91 - 06.93 | XU5M BDY Cat. | 4 | 0,8 | BCPR5ES | 6130 | 32 | LPG 3 | 1498 |
| ZX 1.6 | 1.6 | 66 | 07.95 - 07.98 | TU5JP | 4 | | BKR5EK | 7956 | 23 | LPG 1 | 1496 |
| ZX 1.6 | 1.6 | 66 | 07.93 - 06.95 | XU5JP Cat. | 4 | 0,8 | BCPR5ES | 6130 | 32 | LPG 3 | 1498 |
| ZX 1.6i | 1.6 | 66 | 07.93 - 06.95 | XU5JP BFZ | 4 | 0,8 | BCPR5ES | 6130 | 32 | LPG 3 | 1498 |
| ZX 1.6i | 1.6 | 66 | 07.95 - 07.98 | XU5JP BFZ | 4 | | BKR5EK | 7956 | 23 | LPG 1 | 1496 |
| ZX 1.8 | 1.8 | 76 | 07.95 - | XU7JP Cat. | 4 | | BKR5EK | 7956 | 23 | LPG 1 | 1496 |
| ZX 1.8 | 1.8 | 76 | 07.92 - 06.95 | XU7JP LFZ | 4 | 0,8 | BCPR5ES | 6130 | 32 | LPG 3 | 1498 |
| ZX 1.8 | 1.8 | 82 | 07.97 - | XU7JP4 LFY | 4 | | BKR5EK | 7956 | 23 | LPG 1 | 1496 |
| ZX 1.8 D | 1.8 | 44 | 03.91 - 04.94 | XUD 7 A9A | 4 | ■ | Y-924J | 7906 | | D-POWER 1 | 7906 |
| ZX 1.8 D | 1.8 | 44 | 05.94 - 07.98 | XUD7 | 4 | ■ | Y-923U | 3380 | | D-POWER 1 | 7906 |
| ZX 1.8i | 1.8 | 76 | 07.95 - | XU7JP LFZ | 4 | | BKR5EK | 7956 | 23 | LPG 1 | 1496 |
| ZX 1.9 | 1.9 | 88 | 07.92 - | XU9JA DKZ Cat. | 4 | 0,8 | BCPR5ES | 6130 | 32 | LPG 3 | 1498 |
| ZX 1.9 | 1.9 | 96 | 03.91 - 06.92 | XU9JA D6A | 4 | 0,7 | BCP6ES | 4930 | 17 | LPG 3 | 1498 |
| ZX 1.9 D | 1.9 | 38 | 05.94 - 07.98 | XUD9A/L | 4 | ■ | Y-923U | 3380 | | D-POWER 1 | 7906 |
| ZX 1.9 D | 1.9 | 47 | 03.91 - 04.94 | XUD 9 A/L D9B | 4 | ■ | Y-924J | 7906 | | D-POWER 1 | 7906 |
| ZX 1.9 TD | 1.9 | 68 | 09.92 - 04.94 | XUD 9 T/L D8A | 4 | ■ | Y-923U | 3380 | | D-POWER 1 | 7906 |



ℓ kW

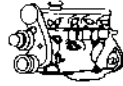

Cyl.

Order-
No.VLINE
No.LPG/CNG
D-PowerOrder-
No.**CITROEN**

| | | | | | | | | | | | |
|-----------|-----|-----|---------------|------------------|---|-----|---------|------|----|-----------|------|
| ZX 1.9 TD | 1.9 | 68 | 05.94 - 07.98 | XUD9T/L | 4 | █ | Y-938R | 5267 | | D-POWER 1 | 7906 |
| ZX 2.0 | 2.0 | 90 | 07.92 - 03.96 | XU10J2C | 4 | 0,8 | BCPR5ES | 6130 | 32 | LPG 3 | 1498 |
| ZX 2.0 | 2.0 | 90 | 04.96 - | XU10J2C Cat. | 4 | | BKR5EK | 7956 | 23 | LPG 1 | 1496 |
| ZX 2.0 | 2.0 | 110 | 07.94 - 06.96 | XU10J4D | 4 | 0,8 | BCPR6ES | 2330 | 12 | LPG 3 | 1498 |
| ZX 2.0 | 2.0 | 110 | 11.92 - 06.96 | XU10J4D RFT Cat. | 4 | | BKR6EK | 2288 | 20 | LPG 1 | 1496 |
| ZX 2.0 | 2.0 | 110 | 07.96 - | XU10J4RS-RFS | 4 | 0,9 | BKR5EZ | 7642 | 36 | LPG 1 | 1496 |
| ZX 2.0i | 2.0 | 90 | 04.96 - | XU10J2 RFX | 4 | | BKR5EK | 7956 | 23 | LPG 1 | 1496 |
| ZX 2.0i | 2.0 | 90 | 07.92 - 03.96 | XU10J2 RFX | 4 | 0,8 | BCPR5ES | 6130 | 32 | LPG 3 | 1498 |

DACIA

| | | | | | | | | | | | |
|-----------------|-----|----|---------|-------------------------|---|-----|--------|------|----|-----------|------|
| Denem | 1.4 | | | | 4 | 0,6 | BP6HS | 4511 | 18 | BPR6HIX | 4085 |
| Duster | 1.4 | | | | 4 | 0,6 | BP6HS | 4511 | 18 | BPR6HIX | 4085 |
| Duster | 1.6 | | 92 - 99 | | 4 | █ | Y-908R | 4585 | | D-POWER 1 | 7906 |
| Logan 1.4 MPI | 1.4 | 55 | 09.04 - | K7J710 | 4 | 0,9 | BKR6E | 6962 | 28 | LPG 1 | 1496 |
| Logan 1.5 dCi | 1.5 | 48 | 09.05 - | K9K790 | 4 | █ | Y-732J | 5605 | | D-POWER 4 | 5605 |
| Logan 1.5 dCi | 1.5 | 50 | 01.06 - | K9K792 | 4 | █ | Y-732J | 5605 | | D-POWER 4 | 5605 |
| Logan 1.6 16V | 1.6 | 77 | 02.06 - | K4MA6 | 4 | 0,9 | BKR6EZ | 4619 | 38 | LPG 1 | 1496 |
| Logan 1.6 MPI | 1.6 | 64 | 09.04 - | K7M710 engine by renaul | 4 | 0,9 | BKR6E | 6962 | 28 | LPG 1 | 1496 |
| Sandero 1.4 Mpi | 1.4 | 55 | 06.08 - | K7J710 | 4 | 0,9 | BKR6E | 6962 | 28 | LPG 1 | 1496 |
| Sandero 1.6 Mpi | 1.6 | 64 | 06.08 - | K7M710 | 4 | 0,9 | BKR6E | 6962 | 28 | LPG 1 | 1496 |

DAEWOO

| | | | | | | | | | | | |
|-----------------------|-----|-----|---------------|----------------|---|-----|-----------|------|----|-----------|------|
| Aranos | 1.8 | 70 | 11.94 - 12.99 | SOHC | 4 | 0,9 | BPR5ES | 7422 | 6 | LPG 2 | 1497 |
| Aranos | 2.0 | 81 | 11.94 - 12.99 | SOHC | 4 | 1,1 | BPR5ES-11 | 4424 | | LPG 2 | 1497 |
| Arcadia | 3.2 | 158 | 09.93 - | V6 | 6 | 1,1 | PFR6J-11 | 2743 | | PFR6J | 2645 |
| Brougham | 2.0 | 85 | 09.91 - 12.95 | C20LE Holden | 4 | 1,1 | BPR5ES-11 | 4424 | | LPG 2 | 1497 |
| Cielo | 1.5 | 57 | 08.94 - 08.97 | G15MF SOHC | 4 | 0,8 | BPR6ES | 7822 | 2 | LPG 2 | 1497 |
| Cielo | 1.5 | 74 | 08.94 - 08.97 | A15MF DOHC | 4 | 1,1 | BKR6E-11 | 2756 | 14 | LPG 1 | 1496 |
| Damas | 0.8 | 28 | 10.91 - 04.93 | F8CB Suzuki | 3 | 0,9 | BPR5ES | 7422 | 6 | LPG 2 | 1497 |
| Espero | 1.5 | 66 | 95 - 10.99 | A15MF DOHC 16V | 4 | 1,1 | BKR6E-11 | 2756 | 14 | LPG 1 | 1496 |
| Espero | 1.8 | 66 | 02.95 - 10.99 | C18LE | 4 | 0,8 | BPR6ES | 7822 | 2 | LPG 2 | 1497 |
| Espero | 2.0 | 77 | 02.95 - 10.99 | C20LE | 4 | 0,8 | BPR6ES | 7822 | 2 | LPG 2 | 1497 |
| Evanda | 2.0 | 96 | 03 - 02.05 | T20SED | 4 | | BKR5EK | 7956 | 23 | LPG 1 | 1496 |
| Imperial | 3.0 | 135 | 02.89 - 08.93 | C30NE Opel | 6 | 0,7 | BPR6HS | 7022 | 3 | BPR7HIX | 5944 |
| Kalos 1.2 SE | 1.2 | 53 | 04.03 - 02.05 | B12S1 | 4 | 1,1 | BPR5EY-11 | 3028 | | LPG 2 | 1497 |
| Kalos 1.4 SE | 1.4 | 61 | 04.03 - 02.05 | F14S3 SOHC | 4 | 0,8 | BPR6ES | 7822 | 2 | LPG 2 | 1497 |
| Kalos 1.4 SE S100 | 1.4 | 61 | 09.02 - 02.05 | F14S3 | 4 | 0,8 | BPR6ES | 7822 | 2 | LPG 2 | 1497 |
| Kalos 1.4 SX | 1.4 | 69 | 04.03 - 02.05 | F14D3 DOHC | 4 | 1,1 | BKR6E-11 | 2756 | 14 | LPG 1 | 1496 |
| Korando | 2.9 | | 04.00 - | | 4 | █ | Y-916J | 5906 | | D-POWER 6 | 5906 |
| Korando TD | 2.3 | 74 | 04.00 - | | 4 | █ | Y-916J | 5906 | | D-POWER 6 | 5906 |
| Korando TD, Cabriolet | 2.9 | 88 | 04.00 - | | 5 | █ | Y-916J | 5906 | | D-POWER 6 | 5906 |
| Labo | 0.8 | | 97 - | SOHC | 4 | 0,8 | BPR6ES | 7822 | 2 | LPG 2 | 1497 |
| Lacetti | 1.4 | 68 | 09.03 - 02.05 | F14D3 | 4 | 1,1 | BKR6E-11 | 2756 | 14 | LPG 1 | 1496 |
| Lacetti | 1.6 | 80 | 09.03 - 02.05 | F16D3 | 4 | 1,1 | BKR6E-11 | 2756 | 14 | LPG 1 | 1496 |
| Lacetti | 1.8 | 90 | 09.03 - 02.05 | T18SED | 4 | | BKR5EK | 7956 | 23 | LPG 1 | 1496 |
| Lanos | 1.4 | 55 | 05.97 - 02.05 | A14SMS SOHC | 4 | 0,8 | BPR6ES | 7822 | 2 | LPG 2 | 1497 |
| Lanos | 1.5 | 63 | 05.97 - 02.05 | A15SMS SOHC | 4 | 0,8 | BPR6ES | 7822 | 2 | LPG 2 | 1497 |
| Lanos | 1.6 | 78 | 05.97 - 02.05 | A16DMS DOHC | 4 | 1,1 | BKR6E-11 | 2756 | 14 | LPG 1 | 1496 |
| Leganza | 2.0 | 100 | 07.97 - 12.02 | X20SED DOHC | 4 | | BKR5EK | 7956 | 23 | LPG 1 | 1496 |
| Leganza | 2.2 | | 07.97 - 12.02 | T22SED DOHC | 4 | | BKR6EK | 2288 | 20 | LPG 1 | 1496 |
| LeMans | 1.5 | | | | 4 | 0,8 | BPR6ES | 7822 | 2 | LPG 2 | 1497 |
| LeMans | 1.5 | | | DOHC | 4 | 1,1 | BKR6E-11 | 2756 | 14 | LPG 1 | 1496 |



l kW



Cyl.

Order-
No. No.LPG/CNG
D-PowerOrder-
No.**DAEWOO**

| | | | | | | | | | | | |
|---------------------|-----|-----|---------------|------------------|---|-----|-----------|------|----|------------|------|
| Matiz | 0.8 | 38 | 06.98 - 02.05 | F8CV | 3 | 1,1 | BPR5EY-11 | 3028 | | LPG 2 | 1497 |
| Matiz | 1.0 | 47 | 03.03 - 02.05 | B10S | 4 | 1,1 | BPR5EY-11 | 3028 | | LPG 2 | 1497 |
| Musso | 2.0 | 100 | 09.96 - | M 161.940 | 4 | 0,8 | BCP5ES | 7496 | 16 | LPG 3 | 1498 |
| Musso | 2.9 | | 04.00 - | | 4 | █ | Y-916J | 5906 | | D-POWER 6 | 5906 |
| Musso E32 | 3.2 | 162 | 05.96 - | Mercedes M162990 | 6 | 0,8 | BCP5ES | 7496 | 16 | LPG 3 | 1498 |
| Musso 16V | 2.3 | 110 | 11.96 - | M 161.970 | 4 | 0,8 | BCP5ES | 7496 | 16 | LPG 3 | 1498 |
| Musso SELTD | 2.9 | 88 | 04.00 - | | 5 | █ | Y-916J | 5906 | | D-POWER 6 | 5906 |
| Musso SLTD | 2.3 | 74 | 04.00 - | | 4 | █ | Y-916J | 5906 | | D-POWER 6 | 5906 |
| New Brougham | 2.0 | 85 | 01.96 - 02.97 | SOHC | 4 | 1,1 | BPR5ES-11 | 4424 | | LPG 2 | 1497 |
| New Brougham | 2.0 | 106 | 01.96 - 02.97 | DOHC 16V | 4 | | BKR5EK | 7956 | 23 | LPG 1 | 1496 |
| New Brougham | 2.2 | 110 | 01.96 - 02.97 | DOHC 16V | 4 | | BKR5EK | 7956 | 23 | LPG 1 | 1496 |
| New Prince | 1.8 | 81 | 04.96 - 02.97 | SOHC | 4 | 1,1 | BPR5ES-11 | 4424 | | LPG 2 | 1497 |
| New Prince | 1.8 | 101 | 04.96 - 02.97 | DOHC 16V | 4 | | BKR5EK | 7956 | 23 | LPG 1 | 1496 |
| New Prince | 2.0 | 85 | 04.96 - 02.97 | SOHC | 4 | 1,1 | BPR5ES-11 | 4424 | | LPG 2 | 1497 |
| New Prince | 2.0 | 106 | 04.96 - 02.97 | DOHC 16V | 4 | | BKR5EK | 7956 | 23 | LPG 1 | 1496 |
| Nexia | 1.5 | 55 | 02.95 - | OHC | 4 | 0,8 | BPR6ES | 7822 | 2 | LPG 2 | 1497 |
| Nexia | 1.5 | 66 | 02.95 - | DOHC 16V | 4 | 1,1 | BKR6E-11 | 2756 | 14 | LPG 1 | 1496 |
| Nexia | 1.8 | 74 | 12.95 - 10.96 | C18LE SOHC | 4 | 0,8 | BPR6ES | 7822 | 2 | LPG 2 | 1497 |
| Nubira | 1.6 | 80 | 07.97 - 02.05 | A16DMS DOHC | 4 | 1,1 | BKR6E-11 | 2756 | 14 | LPG 1 | 1496 |
| Nubira | 2.0 | 99 | 07.97 - 02.05 | X20SED DOHC | 4 | | BKR5EK | 7956 | 23 | LPG 1 | 1496 |
| Nubira 1.8 CDX | 1.8 | 90 | 03 - 02.05 | T18SED | 4 | | BKR5EK | 7956 | 23 | LPG 1 | 1496 |
| Racer | 1.5 | | 01.88 - 02.93 | | 4 | 0,9 | BPR5ES | 7422 | 6 | LPG 2 | 1497 |
| Rexton 290 RX Td | 2.9 | 87 | 05.02 - | Mercedes | 5 | █ | Y-929U | 1749 | | D-POWER 41 | 1749 |
| Rezzo / Tacuma U100 | 1.6 | 77 | 01 - 02.05 | A16DMS | 4 | 1,1 | BKR5E-11 | 6953 | 33 | LPG 1 | 1496 |
| Rezzo / Tacuma U100 | 2.0 | 89 | 01 - 02.05 | T20SED | 4 | | BKR5EK | 7956 | 23 | LPG 1 | 1496 |
| Royal Duke | 1.5 | 65 | 05.87 - 12.89 | | 4 | 0,8 | BPR6EY | 6427 | | LPG 2 | 1497 |
| Royal Prince | 1.5 | 65 | 01.88 - 12.89 | | 4 | 0,8 | BPR6EY | 6427 | | LPG 2 | 1497 |
| Royal Prince | 1.9 | 78 | 09.80 - 12.87 | | 4 | 0,7 | BPR6HS | 7022 | 3 | BPR7HIX | 5944 |
| Royal Prince | 2.0 | 87 | 09.80 - 12.87 | | 4 | 0,7 | BPR6HS | 7022 | 3 | BPR7HIX | 5944 |
| Royal Prince i. | 1.5 | 55 | 01.90 - 12.90 | | 4 | 0,8 | BPR6EY | 6427 | | LPG 2 | 1497 |
| Royal Prince i. | 1.9 | 78 | 01.88 - 12.90 | | 4 | 0,7 | BPR6HS | 7022 | 3 | BPR7HIX | 5944 |
| Royal Prince i. | 2.0 | 94 | 01.88 - 12.90 | | 4 | 0,7 | BPR6HS | 7022 | 3 | BPR7HIX | 5944 |
| Royal Salon i. | 2.0 | 94 | 01.88 - 12.90 | | 4 | 0,7 | BPR6HS | 7022 | 3 | BPR7HIX | 5944 |
| Royal XQ | 1.5 | 62 | 08.82 - 05.86 | | 4 | 0,7 | BPR6HS | 7022 | 3 | BPR7HIX | 5944 |
| Super Salon | 2.0 | 81 | 09.91 - 12.95 | C20LE Holden | 4 | 1,1 | BPR5ES-11 | 4424 | | LPG 2 | 1497 |
| Tacuma | 1.6 | | 01 - | L4 DOHC | 4 | 1,1 | BKR6E-11 | 2756 | 14 | LPG 1 | 1496 |
| Tacuma | 1.8 | | 01 - | L4 SOHC | 4 | 0,9 | BPR5ES | 7422 | 6 | LPG 2 | 1497 |
| Tacuma | 2.0 | | 01 - | L4 DOHC | 4 | | BKR5EK | 7956 | 23 | LPG 1 | 1496 |
| Tico | 0.8 | 30 | | SOHC leaded | 3 | 0,9 | BPR5ES | 7422 | 6 | LPG 2 | 1497 |
| Tico | 0.8 | | | SOHC unleaded | 3 | 1,1 | BPR5EY-11 | 3028 | | LPG 2 | 1497 |

DAF

| | | | | | | | | | | | |
|--------------|-----|----|---------------|--|---|---|--------|------|--|-----------|------|
| 400 Serie D | 2.5 | 53 | 04.89 - 08.93 | | 4 | █ | Y-922R | 4356 | | D-POWER 1 | 7906 |
| 400 Serie TD | 2.5 | 71 | 04.89 - 08.93 | | 4 | █ | Y-922R | 4356 | | D-POWER 1 | 7906 |

DAIHATSU

| | | | | | | | | | | | |
|-----------------|-----|----|------|---------|---|-----|---------|------|----|-------|------|
| Applause A101 | 1.6 | 66 | | HD-E | 4 | 0,9 | BKR6E | 6962 | 28 | LPG 1 | 1496 |
| Applause A101 | 1.6 | 73 | | HD-E EG | 4 | | BKUR6EK | 2213 | | | |
| Applause A101 | 1.6 | 77 | | HD-E | 4 | 0,9 | BKR6E | 6962 | 28 | LPG 1 | 1496 |
| Applause A111 | 1.6 | 77 | | HD-E | 4 | 0,9 | BKR6E | 6962 | 28 | LPG 1 | 1496 |
| Bertone 184BEO | 2.7 | 95 | | 276KB | 6 | 0,8 | ZGR5A | 5839 | 15 | | |
| Charade CL10,60 | 1.0 | 27 | 86 - | CL | 4 | █ | Y-703R | 3782 | | | |



ℓ kW

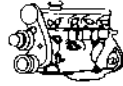

Cyl.

Order-
No.LPG/CNG
D-PowerOrder-
No.**DAIHATSU**

| | | | | | | | | | | |
|-----------------------|------|----|-------------|--------|---|---------------|------|----|----------|------|
| Charade CL10,60 / G30 | 1.0 | 27 | 10.83-02.87 | CL | 4 | Y-146R | 7492 | | | |
| Charade CL50 | 1.0 | | - 85 | CL | 4 | Y-146R | 7492 | | | |
| Charade CL50 | 1.0 | | 86- | CL | 4 | Y-703R | 3782 | | | |
| Charade G102 | 1.3 | 66 | 07.91- | HC-E | 4 | 1,1 BKR6E-11 | 2756 | 14 | LPG 1 | 1496 |
| Charade G112 4WD | 1.3 | 66 | 02.97- | HC-E | 4 | 1,1 BKR6E-11 | 2756 | 14 | LPG 1 | 1496 |
| Charade G200 | 1.3 | 44 | | HC | 4 | 1,1 BKR6E-11 | 2756 | 14 | LPG 1 | 1496 |
| Charade G200 | 1.3 | 55 | | HC | 4 | 1,1 BKR6E-11 | 2756 | 14 | LPG 1 | 1496 |
| Charade G200 | 1.3 | 62 | | HC | 4 | 1,1 BKR6E-11 | 2756 | 14 | LPG 1 | 1496 |
| Charade G201 | 1.6 | 77 | | HD-E | 4 | 1,1 BKR6E-11 | 2756 | 14 | LPG 1 | 1496 |
| Charade G203 | 1.5 | 55 | | HE | 4 | 1,1 BKR6E-11 | 2756 | 14 | LPG 1 | 1496 |
| Charade G203 | 1.5 | 66 | | HE | 4 | 1,1 BKR6E-11 | 2756 | 14 | LPG 1 | 1496 |
| Charade G10 | 1.0 | 38 | 81- | CB20 | 3 | 0,8 BPR5EA-L | 5823 | | | |
| Charade G11 | 1.0 | 38 | 83- | CB22 | 3 | 0,8 BPR5EA-L | 5823 | | | |
| Charade GTi G100 | 1.0 | 74 | 03.87- | CB80 | 3 | 0,8 BPR6EKN | 1128 | | | |
| Copen | 1.3 | 64 | 06- | K3- | 4 | 1,1 IFR6J11 | 7658 | | IFR6J11 | 7658 |
| Copen L880K | 0.66 | 50 | 04- | JB-DET | 4 | 1,1 IFR6J11 | 7658 | | IFR6J11 | 7658 |
| Cuore L201 | 0.85 | 30 | | ED10 | 3 | 0,8 BPR6EY | 6427 | | LPG 2 | 1497 |
| Cuore L251 | 1.0 | 43 | 05.03- | EJ-VE | 3 | BKR5EKC | 5216 | | | |
| Cuore L501 | 0.85 | 32 | 05.95-04.96 | ED20 | 3 | 0,8 BPR6EY | 6427 | | LPG 2 | 1497 |
| Cuore L501 | 0.85 | 32 | 05.96- | ED20 | 3 | 1,1 BPR5EY-11 | 3028 | | LPG 2 | 1497 |
| Cuore L55 | 0.54 | 21 | | AB30 | 3 | 0,8 BPR6ES | 7822 | 2 | LPG 2 | 1497 |
| Cuore L60 | 0.61 | 22 | | AD10 | 3 | 0,8 BPR6ES | 7822 | 2 | LPG 2 | 1497 |
| Cuore L701 | 1.0 | 40 | 06.98- 01 | EJ-DE | 3 | 1,1 BKR5E-11 | 6953 | 33 | LPG 1 | 1496 |
| Cuore L701 | 1.0 | 43 | 07.01- | EJ-VE | 3 | BKR5EKC | 5216 | | | |
| Cuore L80 | 0.85 | 32 | | ED10 | 3 | 0,8 BPR6EY | 6427 | | LPG 2 | 1497 |
| Cuore 1.0 Top L276 | 1.0 | 52 | 09.07- | 1KR-FE | 3 | 1,1 IIFR6T11 | 4904 | | IIFR6T11 | 4904 |
| Delta Truck D (3B) | | | 02.83- | 3 B | 4 | Y-147T | 7493 | | | |
| Delta Truck D (B) | | | 02.83- | B | 4 | Y-147T | 7493 | | | |
| Delta Truck D | | | 02.83- | DL40 | 4 | Y-128T | 7227 | | | |
| Domino | 0.6 | | - 86 | | 2 | 0,8 BPR6ES | 7822 | 2 | LPG 2 | 1497 |
| Esse L235S | 0.66 | | 12.05- | KF-VE | 3 | 0,9 LKR7C | 4472 | | LKR7C | 4472 |
| Esse L245S | 0.66 | | 12.05- | KF-VE | 3 | 0,9 LKR7C | 4472 | | LKR7C | 4472 |
| Extol | 1.3 | 63 | 07.00- | K3-VE | 4 | BKUR6ETB-10 | 5742 | | | |
| Feroza F300 | 1.6 | 63 | 10.88- | HD-E | 4 | 1,1 BKR6E-11 | 2756 | 14 | LPG 1 | 1496 |
| Fourtrak | 2.0 | | 86- | | 4 | 0,8 BPR5EY | 2828 | 9 | LPG 2 | 1497 |
| Fourtrak | 2.2 | | 86- | DL52 | 4 | 0,8 BPR5EY | 2828 | 9 | LPG 2 | 1497 |
| Fourtrak | 2.8 | | - 84 | DL40 | 4 | Y-128T | 7227 | | | |
| Fourtrak | 2.8 | | 84- 93 | DL50 | 4 | Y-146R | 7492 | | | |
| Fourtrak | 2.8 | | 10.89- 93 | DL-T | 4 | Y-146R | 7492 | | | |
| Gran Move G301 | 1.6 | 67 | 07.99- | HD-EP | 4 | 1,1 BKR6E-11 | 2756 | 14 | LPG 1 | 1496 |
| Gran Move G303 | 1.5 | 66 | 04.97- | HE-EG | 4 | 1,1 BKR6E-11 | 2756 | 14 | LPG 1 | 1496 |
| Gran Move L901 | 1.0 | 40 | 10.99- | EJ-DE | 3 | BKUR6EK | 2213 | | | |
| Hijet | 1.0 | | 86- | CB42 | 3 | 0,8 BPR5EY | 2828 | 9 | LPG 2 | 1497 |
| Hijet | 1.3 | 48 | 08.98- | HC-ES | 4 | BKUR6EK | 2213 | | | |
| Hijet S77/N | | | | CL20 | 4 | Y-146R | 7492 | | | |
| Hijet S75 | 0.9 | 33 | | CB41 | 3 | 0,8 BPR5EY | 2828 | 9 | LPG 2 | 1497 |
| Hijet S76 | 0.9 | 33 | | CB41 | 3 | 0,8 BPR5EY | 2828 | 9 | LPG 2 | 1497 |
| Hijet S77 | 0.9 | 33 | | CB41 | 3 | 0,8 BPR5EY | 2828 | 9 | LPG 2 | 1497 |
| Hijet S85 | 0.9 | 33 | | CB41 | 3 | 0,8 BPR5EY | 2828 | 9 | LPG 2 | 1497 |
| Hijet S86 | 0.9 | 33 | | CB41 | 3 | 0,8 BPR5EY | 2828 | 9 | LPG 2 | 1497 |
| Materia 1.3 | 1.3 | 67 | 12.06- | K3-VE | 4 | IKR7D | 4759 | | IKR7D | 4759 |
| Materia 1.5 | 1.5 | 76 | 12.06- | 3SZ-VE | 4 | IKR7D | 4759 | | IKR7D | 4759 |



ℓ kW



Cyl.

Order-
No. No.LPG/CNG
D-PowerOrder-
No.**DAIHATSU**

| | | | | | | | | | | | |
|---------------------------------|------|----|---------------|-----------------|---|-----|-------------|------|----|----------|------|
| Mira | 0.85 | | 01.93 - 97 | ED10 (K) | 3 | 0,9 | BPR6EY | 6427 | | LPG 2 | 1497 |
| Mira L235S | 0.66 | | 12.05 - | KF-VE | 3 | 0,9 | LKR7C | 4472 | | LKR7C | 4472 |
| Mira L245S | 0.66 | | 12.05 - | KF-VE | 3 | 0,9 | LKR7C | 4472 | | LKR7C | 4472 |
| Mira Turbo | 0.5 | | 80 - 85 | | 4 | 0,8 | BPR6ES | 7822 | 2 | LPG 2 | 1497 |
| Move L235S | 0.66 | | 12.05 - | KF-VE | 3 | 0,9 | LKR7C | 4472 | | LKR7C | 4472 |
| Move L245S | 0.66 | | 12.05 - | KF-VE | 3 | 0,9 | LKR7C | 4472 | | LKR7C | 4472 |
| Move L601 | 0.85 | 31 | 97 - 10.00 | ED20 | 3 | 1,1 | BPR5EY-11 | 3028 | | LPG 2 | 1497 |
| Move L901 | 1.0 | 40 | 10.99 - 09.02 | EJ-DE | 3 | | BKUR6EK | 2213 | | | |
| Piaggio-Hijet S85 | 0.9 | 33 | | CB41 | 3 | 0,8 | BPR6EY | 6427 | | LPG 2 | 1497 |
| Rocky | 2.8 | 54 | 02.85 - | DL | 4 | █ | Y-146R | 7492 | | | |
| Rocky | 2.8 | 67 | 12.87 - 04.93 | DL51 | 4 | █ | Y-146R | 7492 | | | |
| Rocky 4WD | 2.8 | | 85 - | DL40 | 4 | █ | Y-128T | 7227 | | | |
| Rocky 4WD D | 2.8 | 54 | 85 - | DL50 | 4 | █ | Y-146R | 7492 | | | |
| Rocky 4WD TD | | | | DL42 | 4 | █ | Y-146R | 7492 | | | |
| Rocky F80 | 2.0 | 65 | 04.84 - 04.93 | 3Y | 4 | 0,8 | BP5EY | 7327 | | LPG 2 | 1497 |
| Rocky F85 | 2.0 | 65 | 04.84 - 04.93 | 3Y | 4 | 0,8 | BP5EY | 7327 | | LPG 2 | 1497 |
| Rocky TD | 2.8 | 67 | 12.87 - 04.93 | DL 51 | 4 | █ | Y-146R | 7492 | | | |
| Rocky TD | 2.8 | 72 | 05.93 - | DL 52 | 4 | █ | Y-146R | 7492 | | | |
| Rocky TD | 2.8 | 75 | 09.91 - | DL 52 | 4 | █ | Y-146R | 7492 | | | |
| Sirion | 1.5 | 76 | | 3SZ-VE | 4 | 0,9 | DCPR7EA-9 | 6651 | | | |
| Sirion (M100)(M110) | 1.0 | 40 | 06.98 - 00 | EJ-DE | 3 | | BKUR6EK | 2213 | | | |
| Sirion (M100)(M110) | 1.0 | 43 | 05.00 - 04 | EJ-VE | 3 | | BKR5EKC | 5216 | | | |
| Sirion (M101)(M111) | 1.3 | 75 | 09.01 - 04 | K3-VE2 | 3 | | BKUR6ETB-10 | 5742 | | | |
| Sirion (M300) | 1.0 | 51 | 01.05 - | 1KR-FE | 3 | 1,1 | ILFR6T11 | 4904 | | ILFR6T11 | 4904 |
| Sirion (M300) | 1.3 | 64 | 01.05 - | K3-VE | 4 | 1,1 | IFR6J11 | 7658 | | IFR6J11 | 7658 |
| Sirion (M301) | 1.3 | 75 | 09.00 - 04 | K3-VE | 4 | 1,1 | IFR6J11 | 7658 | | IFR6J11 | 7658 |
| Sparcar S65 | 0.55 | 20 | | AB20 | 2 | 0,8 | BPR5EY | 2828 | 9 | LPG 2 | 1497 |
| Sparcar S70 | 0.8 | 29 | 09.83 - 05.86 | CD20 | 2 | 0,8 | BPR6EY | 6427 | | LPG 2 | 1497 |
| Sportrak | 1.6 | | | | 4 | 1,1 | BKR6E-11 | 2756 | 14 | LPG 1 | 1496 |
| Taft | 1.6 | | - 81 | | 4 | 0,9 | BPR5ES | 7422 | 6 | LPG 2 | 1497 |
| Taft | 1.6 | | 82 - | | 4 | 0,8 | BPR5EAL | 5823 | | | |
| Taft 4WD D | | | 10.82 - | DL40 | 4 | █ | Y-128T | 7227 | | | |
| Terios 1.3 J100 | 1.3 | 61 | 09.97 - 00 | HC-EJ Aluengien | 4 | | BKUR6EK | 2213 | | | |
| Terios 1.3 J102 | 1.3 | 63 | 05.00 - 12.05 | K3-VE | 4 | | BKUR6ETB-10 | 5742 | | | |
| Terios 1.3 J211 | 1.3 | | 08 - | K3-VE | 4 | 1,1 | BKR6EY-11 | 4368 | | LPG 1 | 1496 |
| Terios 1.5 | 1.5 | 77 | 01.06 - | 3SZ-VE | 4 | | IKR7D | 4759 | | IKR7D | 4759 |
| Trevis automatic | 1.0 | 43 | 09.06 - | EJ-VE | 4 | | BKR6EKC | 2848 | 26 | LPG 1 | 1496 |
| Trevis Schaltgetriebe / gearbox | 1.0 | 43 | 09.06 - | EJ-VE | 4 | | BKUR6EK | 2213 | | | |
| Valèra i SX | 1.5 | 55 | 96 - | | 4 | 1,1 | BKR6E-11 | 2756 | 14 | LPG 1 | 1496 |
| Valèra i SX | 1.5 | 66 | 95 - | HE-EG | 4 | 1,1 | BKR6E-11 | 2756 | 14 | LPG 1 | 1496 |
| Wildcat D | 2.8 | 54 | 02.85 - 03.88 | DL | 4 | █ | Y-146R | 7492 | | | |
| Wildcat TD | 2.8 | 65 | 09.85 - 04.87 | DL 50 | 4 | █ | Y-146R | 7492 | | | |
| YRV (M200) | 1.0 | 43 | 08.00 - 07.05 | EJ-VE | 4 | | BKR5EKC | 5216 | | | |
| YRV (M201)(M211) | 1.3 | 64 | 01.01 - 07.05 | K3-VE | 4 | | BKUR6ETB-10 | 5742 | | | |
| YRV (M201)Turbo | 1.3 | 95 | 02 - 07.05 | K3-VET | 4 | 0,8 | BKR6EP-8 | 2215 | | LPG 1 | 1496 |

DAIMLER

| | | | | | | | | | | | |
|--------------|-----|-----|---------------|-----|---|-----|-----------|------|----|-------|------|
| 3.6 Litre | 3.6 | 163 | 10.86 - 09.89 | AJ6 | 6 | 0,8 | BCPR6ES | 2330 | 12 | LPG 3 | 1498 |
| 4.0 Litre | 4.0 | 164 | 09.89 - 09.94 | AJ6 | 6 | 0,8 | BCPR6ES | 2330 | 12 | LPG 3 | 1498 |
| 4.0 Super V8 | 4.0 | | 03.00 - 03.02 | | 8 | 1,1 | PFR5G-11E | 3000 | | | |
| 4.0 Super V8 | 4.0 | | 03.02 - | | 8 | 1,0 | IFR5N10 | 7866 | | | |
| 4.0 Super V8 | 4.0 | | 09.97 - 03.00 | | 8 | 1,3 | PFR6G-13E | 2341 | | | |



ℓ kW



Cyl.

Order-
No.LPG/CNG
D-PowerOrder-
No.**DAIMLER**

| | | | | | | | | | | | |
|------------------|-----|-----|---------------|--------|----|-----|-------------|------|----|-------|------|
| 4.0 Super V8 | 4.0 | 267 | 09.97 - 03.00 | V8 | 8 | 1,3 | PFR6G-13E | 2341 | | | |
| 4.0 Super V8 | 4.0 | | 03.00 - 03.02 | AJ26 | 8 | 1,1 | PFR5G-11E | 3000 | | | |
| 4.0 V8 | 4.0 | | 03.00 - 03.02 | | 8 | 1,1 | PFR5G-11E | 3000 | | | |
| 4.0 V8 | 4.0 | | 03.02 - | | 8 | 1,0 | IFR5N10 | 7866 | | | |
| 4.0 V8 | 4.0 | | 09.97 - 09.98 | | 8 | 1,3 | BKR5EVXA-13 | 1188 | | | |
| 4.0 V8 | 4.0 | | 09.98 - 03.00 | | 8 | 1,3 | PFR5G-13E | 2761 | | | |
| 4.0 V8 | 4.0 | | 03.00 - 03.02 | AJ26 | 8 | 1,1 | PFR5G-11E | 3000 | | | |
| 4.0 V8 | 4.0 | | 09.97 - 09.98 | AJ26 | 8 | 1,3 | BKR5EVXA-13 | 1188 | | | |
| 4.0 V8 | 4.0 | | 09.98 - 03.00 | AJ26 | 8 | 1,3 | PFR5G-13E | 2761 | | | |
| 4.2 Super V8 | 4.2 | | 03.02 - | AJ26 | 8 | 1,0 | IFR5N10 | 7866 | | | |
| 4.2 V8 | 4.2 | | 03.02 - | AJ26 | 8 | 1,0 | IFR5N10 | 7866 | | | |
| Century 4.0 | 4.0 | 180 | 10.95 - 09.96 | AJ6 | 6 | 0,8 | BCPR6ES | 2330 | 12 | LPG 3 | 1498 |
| Century 6.0 | 6.0 | | 10.95 - 09.96 | HE | 12 | 0,6 | BR6EF | 3177 | | | |
| Double Six | | | 82 - 85 | HE | 12 | 0,6 | BR6EF | 3177 | | | |
| Double Six | | | 86 - 09.91 | HE | 12 | 0,6 | BR7EFS | 1094 | | | |
| Double Six | | | 10.91 - 93 | HE | 12 | 0,6 | BR7EF | 3346 | | | |
| Double Six | 5.3 | | 90 - | V12 HE | 12 | 0,6 | BR7EFS | 1094 | | | |
| Double Six | 6.0 | | 02.93 - 09.94 | HE | 12 | 0,6 | BR7EFS | 1094 | | | |
| Double six | 6.0 | | 09.94 - 09.97 | HE | 12 | 0,6 | BR6EF | 3177 | | | |
| Double Six 5.3 | 5.3 | | - 81 | | 12 | 0,8 | BP5ES | 6511 | 8 | LPG 2 | 1497 |
| Double Six 6.0 | 6.0 | | 93 - | HE | 12 | 0,6 | BR7EF | 3346 | | | |
| DS 420 Limousine | 4.2 | | - 09.92 | XK | 6 | 0,8 | BP5ES | 6511 | 8 | LPG 2 | 1497 |
| Six 4.0 | 4.0 | | 09.94 - 09.97 | AJ6 | 6 | 0,8 | BCPR6ES | 2330 | 12 | LPG 3 | 1498 |
| Sovereign 3.6 | 3.6 | | 86 - 89 | | 8 | 0,8 | BCPR6ES | 2330 | 12 | LPG 3 | 1498 |
| Sovereign 4.0 | 4.0 | | 89 - | | 8 | 0,8 | BCPR6ES | 2330 | 12 | LPG 3 | 1498 |
| Vanden Plas 5.3 | 5.3 | | - 81 | | 12 | 0,8 | BP5ES | 6511 | 8 | LPG 2 | 1497 |

DELOREAN

| | | | | | | | | | | | |
|--------|-----|--|---------|------------|---|-----|-----|------|--|-------|------|
| DMC-12 | 2.9 | | 81 - 83 | — EFI CID— | 6 | 1,0 | TR5 | 2238 | | LPG 5 | 1516 |
|--------|-----|--|---------|------------|---|-----|-----|------|--|-------|------|

DODGE

| | | | | | | | | | | | |
|------------------------|-----|-----|---------|---------------|---|-----|------------|------|----|----------|------|
| Avenger | 2.0 | 115 | 06.07 - | | 6 | 1,1 | PZFR5F-11 | 4363 | | LPG 6 | 1565 |
| Avenger | 2.0 | | 95 - 99 | L4 MPI Y DOHC | 4 | 1,1 | BKR6EVX-11 | 3540 | | LPG 1 | 1496 |
| Avenger | 2.5 | | 95 - | V6 MPI N DOHC | 6 | 1,1 | PFR5G-11 | 2647 | | PFR6G-11 | 5555 |
| Avenger | 2.7 | 138 | 06.07 - | V6 | 6 | 1,3 | LZTR5A-13 | 4612 | | | |
| Caliber 1.8 | 1.8 | 110 | 06 - | | 4 | 1,1 | ZFR5F-11 | 2262 | | LPG 6 | 1565 |
| Caliber 2.0 | 2.0 | 115 | 06 - | | 4 | 1,1 | ZFR5F-11 | 2262 | | LPG 6 | 1565 |
| Caliber 2.4 | 2.4 | 125 | 06 - | | 4 | 1,1 | ZFR5F-11 | 2262 | | LPG 6 | 1565 |
| Charger SRT8 Twinspark | 6.1 | | 06 - | W V8 FI | 8 | 1,3 | LZTR5A-13 | 4612 | | | |
| Colt | 1.5 | | 93 - 94 | L4 MPI A | 4 | 1,1 | BPR5EIX-11 | 2115 | | LPG 2 | 1497 |
| Colt | 1.8 | | 92 - 94 | L4 MPI C | 4 | 1,1 | BKR5EVX-11 | 5182 | | LPG 1 | 1496 |
| Colt | 2.4 | | 93 - 94 | L4 MPI G | 4 | 1,1 | BKR6EVX-11 | 3540 | | LPG 1 | 1496 |
| Colt | 2.4 | | 92 - 92 | L4 MPI W | 4 | 1,1 | BPR5EIX-11 | 2115 | | LPG 2 | 1497 |
| Intrepid | 2.7 | | 98 - | V6 MPI R DOHC | 6 | 1,3 | LZTR5A-13 | 4612 | | | |
| Intrepid | 3.3 | | 94 - 95 | V6 FF U | 6 | 1,2 | GR45 | 2822 | | GR5IX | 7214 |
| Intrepid | 3.3 | | 93 - 97 | V6 MPI T | 6 | 1,2 | GR45 | 2822 | | GR5IX | 7214 |
| Intrepid | 3.5 | | 93 - 97 | V6 MPI F | 6 | 0,9 | FR5-1 | 7252 | | | |
| Magnum SRT8 | 6.1 | | 06 - | W V8 FI | 8 | 1,3 | LZTR5A-13 | 4612 | | | |
| Neon | 2.0 | | 02 - | L4 MPI C SOHC | 4 | 0,8 | BKR6ES | 3783 | 28 | LPG 1 | 1496 |
| Neon | 2.0 | | 95 - 99 | L4 MPI Y DOHC | 4 | 0,8 | BKR6ES | 3783 | 28 | LPG 1 | 1496 |
| R1500-3500 | 3.9 | | 94 - 96 | MPI X | 6 | 0,9 | FR4 | 5188 | | | |
| R1500-3500 | 3.9 | | 97 - 99 | MPI X | 6 | 1,1 | FR5-1 | 7252 | | | |



ℓ kW

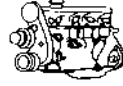

Cyl.

Order-
No. No.

VLINE

LPG/CNG
D-PowerOrder-
No.**DODGE**

| | | | | | | | | | | | |
|---------------|-----|--|---------|----------------------|----|-----|------------|------|--|----------|------|
| R1500-3500 | 5.2 | | 95 - 96 | CNG T | 8 | 0,9 | FR4 | 5188 | | | |
| R1500-3500 | 5.2 | | 97 - 99 | CNG T | 8 | 1,1 | FR5-1 | 7252 | | | |
| R1500-3500 | 5.2 | | 94 - 96 | MPI Y | 8 | 0,9 | FR4 | 5188 | | | |
| R1500-3500 | 5.2 | | 97 - 99 | MPI Y | 8 | 1,1 | FR5-1 | 7252 | | | |
| R1500-3500 | 5.9 | | 97 - 97 | MPI 5 | 8 | 0,9 | FR4 | 5188 | | | |
| R1500-3500 | 5.9 | | 98 - 99 | MPI 5 | 8 | 1,1 | FR5-1 | 7252 | | | |
| R1500-3500 | 5.9 | | 94 - 97 | MPI Z | 8 | 0,9 | FR4 | 5188 | | | |
| R1500-3500 | 5.9 | | 98 - 99 | MPI Z | 8 | 1,1 | FR5-1 | 7252 | | | |
| R1500-3500 | 5.9 | | 94 - 95 | TBI 5 | 8 | 1,1 | WR5 | 1071 | | WR5IX | 7510 |
| R1500-3500 | 8.0 | | 94 - 96 | MPI W | 10 | 1,1 | PZFR5F-11 | 4363 | | LPG 6 | 1565 |
| R1500-3500 | 8.0 | | 97 - 99 | MPI W | 10 | 1,1 | PZFR5F-11 | 4363 | | LPG 6 | 1565 |
| Stealth | 3.0 | | 91 - 92 | V6 MPI B DOHC | 6 | 1,1 | PFR6J-11 | 2743 | | PFR6J | 2645 |
| Stealth | 3.0 | | 93 - 96 | V6 MPI H SOHC | 6 | 1,1 | BPR5EIX-11 | 2115 | | LPG 2 | 1497 |
| Stealth | 3.0 | | 93 - 96 | V6 MPI J DOHC | 6 | 1,1 | PFR6J-11 | 2743 | | PFR6J | 2645 |
| Stealth Turbo | 3.0 | | 91 - 92 | V6 MPI C DOHC | 6 | 1,1 | PFR6J-11 | 2743 | | PFR6J | 2645 |
| Stealth Turbo | 3.0 | | 93 - 96 | V6 MPI K DOHC | 6 | 1,1 | PFR6J-11 | 2743 | | PFR6J | 2645 |
| Stratus | 2.0 | | 95 - | L4 MPI C SOHC | 4 | 0,9 | FR5 | 4876 | | | |
| Stratus | 2.4 | | 95 - 00 | L4 MPI X DOHC | 4 | 1,1 | FR45 | 4636 | | | |
| Stratus | 2.4 | | 04 - | L4 FI X,G | 4 | 1,1 | LZTR4A-11 | 5444 | | | |
| Stratus | 2.4 | | 01 - 03 | L4 FI X,G DOHC/TURBO | 4 | 1,3 | LZTR5A-13 | 4612 | | | |
| Stratus | 2.5 | | 95 - | V6 MPI H DOHC | 6 | 1,1 | PFR5G-11 | 2647 | | PFR6G-11 | 5555 |
| Viper | 8.0 | | 92 - 02 | E V10 MPI | 10 | 0,9 | FR5-1 | 7252 | | | |
| Viper | 8.3 | | 03 - 03 | Z V10 | 10 | 0,8 | ZFR5N | 3459 | | | |
| Viper | 8.3 | | 04 - 06 | Z V10 | 10 | 1,1 | PZFR6F-11 | 3271 | | LPG 6 | 1565 |

DONKERVOORT

| | | | | | | | | | | | |
|------------------|-----|-----|--|------|---|-----|-------|------|----|-------|------|
| D8 1.8 Turbo 20V | 1.8 | 110 | | Audi | 4 | 0,8 | PFR6Q | 6458 | 37 | LPG 1 | 1496 |
|------------------|-----|-----|--|------|---|-----|-------|------|----|-------|------|

EAGLE

| | | | | | | | | | | | |
|-------------|-----|--|---------|----------|---|-----|------------|------|--|-------|------|
| Talon | 2.0 | | 95 - 99 | L4 MPI Y | 4 | 1,1 | BKR6EVX-11 | 3540 | | LPG 1 | 1496 |
| Talon Turbo | 2.0 | | 95 - 99 | L4 MPI F | 4 | 0,9 | BPR6EVX | 6764 | | LPG 2 | 1497 |

FERRARI

| | | | | | | | | | | | |
|----------------------|-----|-----|---------------|---------------|----|-----|----------|------|--|---------|------|
| 348 GTB; GTS | 3.4 | 221 | 01.89 - 03.90 | F119D | 8 | 0,7 | DCPR9EVX | 6436 | | | |
| 348 GTB; GTS | 3.4 | 221 | 04.90 - 03.93 | F119F | 8 | 0,7 | DCPR9EVX | 6436 | | | |
| 348 GTB; GTS | 3.4 | 236 | 03.93 - 06.94 | F119H | 8 | 0,7 | DCPR9EVX | 6436 | | | |
| 360 Spider / F1 | 3.6 | 294 | 09.00 - 11.03 | F131B | 8 | 0,7 | PMR8A | 5851 | | PMR8A | 5851 |
| 360 Spider / F1 | 3.6 | 294 | 12.03 - | F131B | 8 | | PMR8B | 6378 | | PMR9B | 4717 |
| 430 Scuderia | 4.3 | 375 | 08 - | F136ED | 8 | | PMR8B | 6378 | | PMR9B | 4717 |
| 456 M GTA | 5.5 | 325 | 05.98 - | F116C.010 | 12 | 0,7 | DCPR9EVX | 6436 | | | |
| 465 M GT | 5.5 | 325 | 05.98 - | F116C | 12 | 0,7 | DCPR9EVX | 6436 | | | |
| 512 TR | 5.0 | 316 | 02.91 - 10.96 | F113D | 12 | 0,7 | DCPR9EVX | 6436 | | | |
| 575 M Maranello / F1 | 5.7 | 379 | 02.02 - 06.06 | F133E | 12 | 0,7 | DCPR9EVX | 6436 | | | |
| 599 GTB FIORANO | 6.0 | 456 | 05.06 - | F140C | 12 | | PMR8B | 6378 | | PMR9B | 4717 |
| 612 Scaglietti | 5.7 | 397 | 09.04 - | F133F | 12 | 0,7 | DCPR9EVX | 6436 | | | |
| Challenge Stradale | 3.6 | 313 | 01.04 - | F131B | 8 | | PMR8B | 6378 | | PMR9B | 4717 |
| Coupè 360 Modena/F1 | 3.6 | 294 | 12.03 - | F131B | 8 | | PMR8B | 6378 | | PMR9B | 4717 |
| Enzo | 6.0 | 485 | 02 - | F140B | 12 | | PMR8B | 6378 | | PMR9B | 4717 |
| F208 GTB; GTS | 2.0 | 187 | 04.86 - 10.90 | F106N.. | 8 | 0,5 | B95EGV | 2145 | | | |
| F308 GTB; GTS | 3.0 | 157 | 07.81 - 06.85 | F106B | 8 | 0,6 | BP8EVX | 2671 | | BPR9EIX | 6853 |
| F328 GTB; GTS | 3.2 | 199 | 01.88 - 09.89 | F105CB.. | 8 | 0,6 | D8EVX | 2850 | | | |
| F348 TB; TS | 3.4 | 221 | 09.89 - 04.94 | F119D040 Cat. | 8 | 0,6 | D8EVX | 2850 | | | |



ℓ kW



Cyl.

Order-
No.LPG/CNG
D-PowerOrder-
No.**FERRARI**

| | | | | | | | | | | | |
|--|-----|-----|-------------|---------------|----|-----|----------|------|--|---------|------|
| F348 GTB; GTS / Spider | 3.9 | 221 | 07.94-07.95 | F119 | 8 | 0,7 | DCPR9EVX | 6436 | | | |
| F355 | 3.5 | 280 | 05.94-01.96 | F129C | 8 | 0,7 | PMR8A | 5851 | | PMR8A | 5851 |
| F355 Berlinetta | 3.5 | 280 | 07.94- | | 8 | 0,6 | CR8EVX | 6487 | | | |
| F355 F1 berlinetta; GTS; Spider | 3.5 | 280 | 11.97- | F129C | 8 | 0,7 | PMR7A | 4259 | | PMR8A | 5851 |
| F355 Spider | 3.5 | 280 | 07.95- | | 8 | 0,7 | PMR7A | 4259 | | PMR8A | 5851 |
| F355GTS | 3.5 | 280 | 05.94-01.96 | F129B | 8 | 0,7 | PMR8A | 5851 | | PMR8A | 5851 |
| F355GTS | 3.5 | 280 | 02.96- | F129C | 8 | 0,7 | PMR7A | 4259 | | PMR8A | 5851 |
| F40 | 2.9 | 353 | 01.88-05.92 | F120A | 8 | 0,5 | C8E | 7471 | | | |
| F412 | 4.9 | 250 | 06.85-12.88 | F101C.. - E.. | 12 | 0,6 | BP8EVX | 2671 | | BPR9EIX | 6853 |
| F430 Coupé / F430 Spider / F430 Challenge | 4.3 | 360 | 01.05- | F136E | 8 | | PMR8B | 6378 | | PMR9B | 4717 |
| F456 GT | 5.5 | 324 | 02.96-04.98 | F116C | 12 | 0,7 | DCPR9EVX | 6436 | | | |
| F456 GTA | 5.5 | 324 | 07.96-04.98 | F116C.010 | 12 | 0,7 | DCPR9EVX | 6436 | | | |
| F50 | 4.7 | 361 | 05.95- | F130B | 12 | 0,7 | PMR7A | 4259 | | PMR8A | 5851 |
| Modena 360 - 360 F1 | 3.6 | 294 | 05.99-11.03 | F131B | 8 | 0,7 | PMR8A | 5851 | | PMR8A | 5851 |
| Mondial - Cabriolet | 3.0 | 177 | 06.82-06.85 | F105A | 8 | 0,6 | BP8EVX | 2671 | | BPR9EIX | 6853 |
| Mondial / Cabriolet | 3.2 | 191 | 09.85-12.87 | F105C.., Cat | 8 | 0,6 | D8EVX | 2850 | | | |
| Mondial T/ T Cabriolet | 3.4 | 221 | 11.88-02.94 | F119DL Cat | 8 | 0,6 | D8EVX | 2850 | | | |
| Testarossa | 4.9 | 272 | 10.84-10.91 | F113B000 Cat. | 12 | 0,6 | D8EVX | 2850 | | | |
| F456 GT | 5.5 | 324 | 04.93-01.96 | F116B | 12 | 0,7 | DCPR9EVX | 6436 | | | |
| F550 Maranello | 5.5 | 357 | 08.96- | F133A | 12 | 0,7 | DCPR9EVX | 6436 | | | |

FIAT

| | | | | | | | | | | | |
|----------------------------|------|-----|-------------|--------------------------------------|---|-----|-------------|-------|----|------------|-------|
| 126 (650) | 0.65 | 22 | 01.83-06.96 | 141A.000 | 2 | 0,8 | BPR6ES | 7822 | 2 | LPG 2 | 1497 |
| 126 BIS | 0.7 | 19 | 09.87-06.91 | 126 A2.000 | 2 | 0,8 | BPR6ES | 7822 | 2 | LPG 2 | 1497 |
| 127 (1300 Sport) | 1.3 | 55 | 12.81-05.83 | 127A.3000 | 4 | 0,8 | BPR7ES | 2023 | 19 | BPR8EIX | 6684 |
| 127 D | 1.3 | 33 | 06.83-12.86 | | 4 | ☑ | Y-924J | 7906 | | D-POWER 1 | 7906 |
| 127 D | 1.3 | 33 | 04.83-02.87 | 127 A., 127 A 5. | 4 | ☑ | Y-208T | 1250 | | | |
| 131 1300 Panorama CL/Super | 1.3 | 40 | 11.80-01.84 | 131A | 4 | 0,8 | BPR6ES | 7822 | 2 | LPG 2 | 1497 |
| 131 2000 | 2.0 | 83 | 01.81-01.84 | 131C4.. | 4 | 0,8 | BPR6ES | 7822 | 2 | LPG 2 | 1497 |
| 176 TD | 1.7 | | 06.93- | | 4 | ☑ | Y-922R | 4356 | | D-POWER 1 | 7906 |
| 28.40 F 8 Daily D | | | 07.82-12.82 | | 4 | ☑ | Y-208T | 1250 | | | |
| 500 | 1.4 | 102 | 05.08- | 198A1000 | 4 | 0,8 | IKR9F8 | 5756 | | IKR9F8 | 5756 |
| 500 1.2 | 1.2 | 51 | 07.07- | 169A4000 | 4 | 1,0 | ZKR7A-10 | 1691 | | ZKR7A-10 | 1691 |
| 500 1.3 MJT 16V | 1.3 | 56 | 07.07- | 169A1000 | 4 | ☑ | Y8003J | 97256 | | D-POWER 62 | 97256 |
| 500 1.4 16V | 1.4 | 74 | 07.07- | 169A3000 | 4 | 1,0 | DCPR7E-N-10 | 4983 | | | |
| Argenta 100 | 1.6 | 72 | 06.83-11.85 | 132D | 4 | 0,8 | BPR6ES | 7822 | 2 | LPG 2 | 1497 |
| Argenta 120 IE | 2.0 | 90 | 06.83-11.85 | 132C3.. | 4 | 0,8 | BPR7ES | 2023 | 19 | BPR8EIX | 6684 |
| Argenta 1600 | 1.6 | 72 | 06.81-05.83 | 132FB.. | 4 | 0,8 | BPR6ES | 7822 | 2 | LPG 2 | 1497 |
| Argenta 2000 I | 2.0 | 83 | 06.81-05.83 | 132FB.. | 4 | 0,8 | BPR6ES | 7822 | 2 | LPG 2 | 1497 |
| Argenta D | 2.5 | 53 | 06.81-11.85 | B 144.61 | 4 | ☑ | Y-908R | 4585 | | D-POWER 1 | 7906 |
| Argenta TD | 2.4 | 66 | 06.81-11.85 | B 144.81 | 4 | ☑ | Y-908R | 4585 | | D-POWER 1 | 7906 |
| Barchetta | 1.8 | 96 | 04.95-07.00 | 183A1.000 | 4 | | BKR6EKC | 2848 | 26 | LPG 1 | 1496 |
| Barchetta | 1.8 | 96 | 08.00- | 183A1.000 | 4 | 0,9 | BKR6EZ | 4619 | 38 | LPG 1 | 1496 |
| Brava - 12V- S,SX | 1.4 | 59 | 10.95-05.01 | 182A3.000 | 4 | | BKR6EKC | 2848 | 26 | LPG 1 | 1496 |
| Brava 16V | 1.6 | 66 | 10.95-05.01 | 182A6.000 | 4 | | BKR6EKC | 2848 | 26 | LPG 1 | 1496 |
| Brava / o D | 1.9 | 55 | 09.95-10.96 | 160A7.000 | 4 | ☑ | Y-920R | 3645 | | D-POWER 1 | 7906 |
| Brava / o D | 2.0 | 74 | 09.95-07.96 | | 4 | ☑ | Y-923U | 3380 | | D-POWER 1 | 7906 |
| Brava / o D; TD | 1.9 | 55 | 04.96-11.99 | | 4 | ☑ | Y-928U | 4389 | | D-POWER 29 | 4389 |
| Brava / o 1,9 JTD | 1.9 | 77 | 12.99-09.00 | 182B4.000 dal n. motore 1716450 → | 4 | ☑ | Y-534J | 3413 | | D-POWER 36 | 3413 |



ℓ kW



Cyl.

Order-
No. No.LPG/CNG
D-PowerOrder-
No.**FIAT**

| | | | | | | | | | | | |
|--------------------------------------|-----|-----|---------------|--|---|-----|-------------|------|----|------------|------|
| Brava / o 1,9 JTD | 1.9 | 77 | 12.98 - 11.99 | 182B4.000 fino a n. motore →1716458 | 4 | █ | Y-747U | 4694 | | D-POWER 26 | 4694 |
| Brava / o 1.9 JTD | 1.9 | 74 | 09.00 - 10.01 | 182B9000 | 4 | █ | Y-534J | 3413 | | D-POWER 36 | 3413 |
| Brava ;80 16V; Trofeo,Steel Sx,Hsx | 1.2 | 59 | 06.99 - 05.01 | 182B2.000 | 4 | 0,9 | DCPR8E-N | 5692 | | | |
| Brava 100 16V Sx,Hsx,Elx;Aut. | 1.6 | 76 | 07.99 - 05.01 | 182A4.000 | 4 | 0,9 | BKR5EZ | 7642 | 36 | LPG 1 | 1496 |
| Brava 16V | 1.8 | 83 | 10.95 - 05.01 | 182A2.000 | 4 | | BKR6EKC | 2848 | 26 | LPG 1 | 1496 |
| Brava i. 12V | 1.4 | 55 | 10.95 - 02.98 | 182A5.000 | 4 | | BKR6EKC | 2848 | 26 | LPG 1 | 1496 |
| Brava i. 16V EL; aut. EL; ELX | 1.6 | 76 | 10.95 - 06.96 | 182A4.000 | 4 | | BKR6EKC | 2848 | 26 | LPG 1 | 1496 |
| Brava i.,100 16V;Aut. Sx,Hsx,Elx | 1.6 | 76 | 05.98 - 06.99 | 182A4.000 | 4 | | BKR6EKC | 2848 | 26 | LPG 1 | 1496 |
| Brava i.,80 16V Sx,Hsx | 1.2 | 59 | 03.98 - 05.99 | 182B2.000 | 4 | | DCPR8EKC | 7168 | | | |
| Bravo 1.4i 12V S | 1.4 | 59 | 03.98 - 05.01 | 182A3.000 | 4 | | BKR6EKC | 2848 | 26 | LPG 1 | 1496 |
| Bravo 1.8L - 16V GT | 1.8 | 83 | 03.95 - 05.01 | 182A2.000 | 4 | | BKR6EKC | 2848 | 26 | LPG 1 | 1496 |
| Bravo 1.4 16V | 1.4 | 66 | 01.07 - | 192B2000 | 4 | 1,0 | DCPR7E-N-10 | 4983 | | | |
| Bravo 1.4 T-JET 120CV | 1.4 | 88 | 07 - | 198A4000 | 4 | 0,8 | IKR9F8 | 5756 | | IKR9F8 | 5756 |
| Bravo 1.4 T-JET 140CV | 1.4 | 103 | | | 4 | 0,8 | IKR9F8 | 5756 | | IKR9F8 | 5756 |
| Bravo 1.4 T-JET 150CV | 1.4 | 110 | 04.07 - | 198A1000 | 4 | 0,8 | IKR9F8 | 5756 | | IKR9F8 | 5756 |
| Bravo 1.9 MULTIJET 16V | 1.9 | 110 | 01.07 - | 937A5000 | 4 | █ | YE07 | 6092 | | | |
| Bravo 155 20V | 2.0 | 113 | 12.99 - 05.01 | 182A1.000 | 4 | | BKR6EKC | 2848 | 26 | LPG 1 | 1496 |
| Bravo 80 16V Sx Trofeo; Steel | 1.2 | 59 | 06.99 - 05.01 | 182B2.000 | 4 | 0,9 | DCPR8E-N | 5692 | | | |
| Bravo i. 12V | 1.4 | 55 | 10.95 - 02.98 | 182A5.000 | 4 | | BKR6EKC | 2848 | 26 | LPG 1 | 1496 |
| Bravo i. 16V | 1.6 | 66 | 10.95 - 05.01 | 182A6.000 | 4 | | BKR6EKC | 2848 | 26 | LPG 1 | 1496 |
| Bravo i. 20V, 155 HGT | 2.0 | 108 | 10.95 - 05.01 | 182A1.000 | 5 | | BKR6EKC | 2848 | 26 | LPG 1 | 1496 |
| Bravo i., 100 16V EL;Aut. | 1.6 | 76 | 10.95 - 06.01 | 182A4.000 | 4 | | BKR6EKC | 2848 | 26 | LPG 1 | 1496 |
| Bravo i.,80 16V Sx;Trofeo;Steel | 1.2 | 59 | 03.98 - 05.99 | 182B2.000 | 4 | | DCPR8EKC | 7168 | | | |
| Bravo i.100 16V El,Sx,GT,Steel; Aut. | 1.6 | 76 | 07.99 - 05.01 | 182A4.000 | 4 | 0,9 | BKR5EZ | 7642 | 36 | LPG 1 | 1496 |
| Cinquecento | 0.9 | 30 | 92 - 05.98 | 170A1.000 | 4 | 0,8 | BPR6ES | 7822 | 2 | LPG 2 | 1497 |
| Cinquecento | 1.1 | 40 | 10.94 - 05.98 | 176B2.000 | 4 | 0,8 | BCPR6ES | 2330 | 12 | LPG 3 | 1498 |
| Cinquecento 700 ED | 0.7 | 23 | 07.91 - 02.97 | 170A.000 | 2 | 0,8 | BPR6ES | 7822 | 2 | LPG 2 | 1497 |
| Cinquecento 900 | 0.9 | 29 | 02.95 - 05.98 | 1170 A1.046 | 4 | 0,8 | BPR6ES | 7822 | 2 | LPG 2 | 1497 |
| Cinquecento 900 | 0.9 | 30 | 92 - 05.98 | 170A1.046 Cat. | 4 | 0,8 | BPR6ES | 7822 | 2 | LPG 2 | 1497 |
| Cinquecento 900 -Van | 0.9 | 29 | 04.96 - 05.98 | 1170.1046 | 4 | 0,8 | BPR6ES | 7822 | 2 | LPG 2 | 1497 |
| Cinquecento i S,SX,SUITE | 0.9 | 29 | 07.95 - 12.99 | | 4 | 0,8 | BPR6ES | 7822 | 2 | LPG 2 | 1497 |
| Cinquecento Sport | 1.2 | 55 | 04.96 - 05.98 | 176B2.000 | 4 | 0,8 | BCPR6ES | 2330 | 12 | LPG 3 | 1498 |
| Cinquecento Sporting Fire | 1.1 | 40 | 94 - 05.98 | 176A6.000 | 4 | 0,8 | BCPR6ES | 2330 | 12 | LPG 3 | 1498 |
| Coupè 1.8L 16V | 1.8 | 96 | 02.96 - 02.01 | 183A1.000 | 4 | | BKR6EKC | 2848 | 26 | LPG 1 | 1496 |
| Coupè 2.0L 20 V | 2.0 | 108 | 10.96 - 02.01 | 182A1.000 | 5 | | BKR6EKC | 2848 | 26 | LPG 1 | 1496 |
| Coupè 2.0L 16V | 2.0 | 103 | 02.94 - 09.96 | 836A3.000 | 4 | 0,8 | BPR7ES | 2023 | 19 | BPR8EIX | 6684 |
| Coupè 2.0L 16V Turbo | 2.0 | 140 | 02.94 - 09.96 | 175A1.000 | 4 | | BUR6ET | 3172 | 1 | LPG 2 | 1497 |
| Coupè 2.0L 20V Turbo | 2.0 | 162 | - 12.96 | 175A3.000 | 5 | | BKR6EKC | 2848 | 26 | LPG 1 | 1496 |
| Coupè 2.0L 20V Turbo | 2.0 | 162 | 10.96 - 02.01 | 175A3.000 | 5 | | BKUR6ET | 6437 | 27 | LPG 1 | 1496 |
| Croma | 2.5 | 90 | 01.93 - 12.93 | | 4 | █ | Y-914U | 2643 | | D-POWER 1 | 7906 |
| Croma 16V- 2.0L | 2.0 | 101 | 91 - 02.97 | 154E1.000 | 4 | 0,8 | BPR7ES | 2023 | 19 | BPR8EIX | 6684 |
| Croma 2.0L | 2.0 | 84 | 86 - 02.97 | 834.B.146 | 4 | 0,8 | BPR7ES | 2023 | 19 | BPR8EIX | 6684 |
| Croma 1.9 MJT 16V | 1.9 | 110 | 06.05 - | 939A2000 | 4 | █ | YE07 | 6092 | | | |
| Croma 2.0L | 2.0 | 66 | 86 - 91 | 154.C2.000 | 4 | 0,8 | BPR7ES | 2023 | 19 | BPR8EIX | 6684 |
| Croma 2.0L | 2.0 | 85 | 07.91 - 02.97 | 154C3.046 Cat. | 4 | 0,8 | BPR7ES | 2023 | 19 | BPR8EIX | 6684 |
| Croma 2.0L | 2.0 | 89 | 86 - 91 | 154C.000 | 4 | 0,8 | BPR7ES | 2023 | 19 | BPR8EIX | 6684 |
| Croma 2.0L - 16V | 2.0 | 101 | 04.95 - 06.00 | | 4 | 0,8 | BPR7ES | 2023 | 19 | BPR8EIX | 6684 |
| Croma 2.0L -.S | 2.0 | 85 | 04.95 - 99 | | 4 | 0,8 | BPR7ES | 2023 | 19 | BPR8EIX | 6684 |
| Croma 2.4 MJT 20V | 2.4 | 147 | 06.05 - | 939A3000 | 5 | █ | YE07 | 6092 | | | |
| Croma 2.5L | 2.5 | 90 | 01.94 - 98 | | 4 | █ | Y-914U | 2643 | | D-POWER 1 | 7906 |
| Croma CHT- 1.6L | 1.6 | 61 | 12.85 - 06.90 | 154A0..48 | 4 | 0,8 | BPR7ES | 2023 | 19 | BPR8EIX | 6684 |



ℓ kW



Cyl.

Order-
No.VLINE
No.LPG/CNG
D-PowerOrder-
No.

| FIAT | | | | | | | | | | | |
|----------------------------|-----|-----|--------------|-------------------------|---|-----|-------------|-------|----|------------|-------|
| Croma CHT- 2.0L | 2.0 | 72 | 91 -02.97 | 154.C5.000 | 4 | 0,8 | BPR7ES | 2023 | 19 | BPR8EIX | 6684 |
| Croma D | 2.5 | 55 | 12.85 -12.89 | 8144.67 | 4 | █ | Y-924J | 7906 | | D-POWER 1 | 7906 |
| Croma I 2.0L | 2.0 | 86 | 91 -02.97 | 154.C3.000 | 4 | 0,8 | BPR7ES | 2023 | 19 | BPR8EIX | 6684 |
| Croma TD | 2.5 | 74 | 12.85 -02.89 | 8144.91.200 | 4 | █ | Y-908R | 4585 | | D-POWER 1 | 7906 |
| Croma TD | 2.5 | 85 | 01.94 - 99 | | 4 | █ | Y-926U | 7119 | | | |
| Croma Td | 2.5 | 85 | 02.89 -12.92 | 8144.97.200/2200 | 4 | █ | Y-908R | 4585 | | D-POWER 1 | 7906 |
| Croma TD (TDid) | 1.9 | 69 | 07.90 - 98 | 154 C6.000; 154 D 1.000 | 4 | █ | Y-739R | 6639 | | | |
| Croma Ti Turbo | 2.0 | 110 | 86 -02.97 | 154.C4.000 | 4 | | BP6ET | 1263 | | LPG 2 | 1497 |
| Croma Ti Turbo | 2.0 | 110 | 86 -02.97 | 834.C.146 | 4 | | BP6ET | 1263 | | LPG 2 | 1497 |
| Croma Turbo | 2.0 | 110 | 91 -02.97 | 154C4.046 /Cat. | 4 | | BP6ET | 1263 | | LPG 2 | 1497 |
| Croma Turbo | 2.0 | 114 | 86 -02.97 | 154.A2.000 | 4 | | BP6ET | 1263 | | LPG 2 | 1497 |
| Croma Turbo 2.0L | 2.0 | 110 | 04.95 -06.00 | | 4 | | BUR6ET | 3172 | 1 | LPG 2 | 1497 |
| Croma Turbo D | 1.9 | 66 | 03.88 -06.90 | 154 B | 4 | █ | Y-739R | 6639 | | | |
| Croma V6- 2.5L | 2.5 | 117 | 04.95 - 99 | | 6 | 0,8 | BPR7ES | 2023 | 19 | BPR8EIX | 6684 |
| Croma V6- 2.5L | 2.5 | 117 | 93 -02.97 | 834G.000 | 6 | 0,8 | BPR7ES | 2023 | 19 | BPR8EIX | 6684 |
| Doblò | 1.2 | 48 | 11.00 -12.04 | 223A5.000 | 4 | 0,9 | BKR5EZ | 7642 | 36 | LPG 1 | 1496 |
| Doblò | 1.2 | 48 | 12.04 -02.05 | 223A5.000 | 4 | 1,0 | DCPR7E-N-10 | 4983 | | | |
| Doblò | 1.4 | 56 | 09.05 - | 350A1.000 | 4 | 1,0 | ZKR7A-10 | 1691 | | ZKR7A-10 | 1691 |
| Doblò 1,9 D | 1.9 | 46 | 11.00 -04.04 | 223A6000 | 4 | █ | Y-939J | 5059 | | D-POWER 43 | 5059 |
| Doblò 1.3 MJT 16V 85CV | 1.3 | 62 | 11.05 - | 223A9000 | 4 | █ | Y8003J | 97256 | | D-POWER 62 | 97256 |
| Doblò 1.3 MJT 75CV | 1.3 | 55 | 08.05 - | 199A2000 | 4 | █ | Y8003J | 97256 | | D-POWER 62 | 97256 |
| Doblò 1.4 | 1.4 | 70 | 09 - | | 4 | 1,0 | DCPR7E-N-10 | 4983 | | | |
| Doblò 1.6 | 1.6 | 76 | 11.00 -06.05 | 182B6.000 | 4 | 0,9 | BKR5EZ | 7642 | 36 | LPG 1 | 1496 |
| Doblò 1.9 MJT 105CV | 1.9 | 77 | 07.03 -09.05 | 223A7000 | 4 | █ | Y-534J | 3413 | | D-POWER 36 | 3413 |
| Doblò JTD | 1.9 | 74 | 10.01 -06.03 | 182B9000 | 4 | █ | Y-534J | 3413 | | D-POWER 36 | 3413 |
| Doblò MJ | 1.3 | 51 | 11.03 -12.05 | 188A9000 | 4 | █ | Y8003J | 97256 | | D-POWER 62 | 97256 |
| Doblò Natural Power Active | 1.6 | 76 | 11.00 - | 182B6.000 | 4 | | BKR6EKC | 2848 | 26 | LPG 1 | 1496 |
| Ducato (230) 2,8D | 2.8 | 64 | 02.98 - | | | █ | Y-502R | 3852 | | | |
| Ducato 10 | 1.8 | 49 | 09.81 -12.90 | XM7T/ 169B XM | 4 | 0,7 | BP6ES | 7811 | 4 | LPG 2 | 1497 |
| Ducato 10 | 2.0 | 55 | 09.81 -12.85 | XN1T/ 170B XN | 4 | 0,7 | BP6ES | 7811 | 4 | LPG 2 | 1497 |
| Ducato 10 | 2.0 | 62 | 06.88 - | 170D XN 1TA | 4 | 0,7 | BP6ES | 7811 | 4 | LPG 2 | 1497 |
| Ducato 10 D | 2.0 | 52 | 02.87 - | 149 B1.000 | 4 | █ | Y-924J | 7906 | | D-POWER 1 | 7906 |
| Ducato 10 D | 2.5 | 53 | 01.86 -02.94 | 8144.67 | 4 | █ | Y-908R | 4585 | | D-POWER 1 | 7906 |
| Ducato 10 TD | 2.0 | 60 | 01.90 -02.94 | 280 A1.000 | 4 | █ | Y-914U | 2643 | | D-POWER 1 | 7906 |
| Ducato 10, 13 D | 2.5 | 53 | -06.82 | | 4 | █ | Y-208T | 1250 | | | |
| Ducato 10, 13 D | 2.5 | 53 | 07.82 -12.85 | | 4 | █ | Y-208T | 1250 | | | |
| Ducato 10-14 Maxi | 2.0 | 80 | 01.94 - | RFW | 4 | 0,7 | BP6ES | 7811 | 4 | LPG 2 | 1497 |
| Ducato 10D D | 1.9 | 51 | 03.94 - | | 4 | █ | Y-914U | 2643 | | D-POWER 1 | 7906 |
| Ducato 10TD | 1.9 | 59 | 03.94 - | Kat. | 4 | █ | Y-922R | 4356 | | D-POWER 1 | 7906 |
| Ducato 10TD | 1.9 | 60 | 03.94 - | | 4 | █ | Y-914U | 2643 | | D-POWER 1 | 7906 |
| Ducato 13 | 2.0 | 55 | 09.81 -12.85 | XN1T / 170BXN | 4 | 0,7 | BP6ES | 7811 | 4 | LPG 2 | 1497 |
| Ducato 14 | 2.0 | 55 | 01.86 -01.94 | 170BXN1T/170DXN 1TA | 4 | 0,7 | BP6ES | 7811 | 4 | LPG 2 | 1497 |
| Ducato 14 D | 2.4 | | 01.86 -02.94 | | 4 | █ | Y-908R | 4585 | | D-POWER 1 | 7906 |
| Ducato 14 D | 2.5 | 55 | 01.86 -02.94 | 8144.67.220 | 4 | █ | Y-908R | 4585 | | D-POWER 1 | 7906 |
| Ducato 14 D 4x4 | 2.5 | 55 | 01.89 -02.94 | 8144.67.220 | 4 | █ | Y-908R | 4585 | | D-POWER 1 | 7906 |
| Ducato 14 TD | 1.9 | 60 | 01.90 -02.94 | 280 A 1.000 | 4 | █ | Y-914U | 2643 | | D-POWER 1 | 7906 |
| Ducato 14 TD | 2.4 | 68 | 01.86 -02.94 | 8144.21.220 | 4 | █ | Y-908R | 4585 | | D-POWER 1 | 7906 |
| Ducato 14 TD 4x4 | 2.5 | 68 | 01.89 -02.94 | 8144.21.220 | 4 | █ | Y-914U | 2643 | | D-POWER 1 | 7906 |
| Ducato 14 TDi | 2.5 | 81 | 03.94 - | 8140.47.2280 Kat. | | █ | Y-910J | 3617 | | D-POWER 3 | 3617 |
| Ducato 18 Maxi | 2.0 | 62 | 06.86 -06.90 | 170C XN 1TA | 4 | 0,7 | BP6ES | 7811 | 4 | LPG 2 | 1497 |
| Ducato 18 Maxi D | 2.5 | 55 | 01.86 -02.94 | | | █ | Y-910J | 3617 | | D-POWER 3 | 3617 |
| Ducato 18 Maxi TD | 2.5 | 68 | 01.86 -02.94 | 8144.21.220 | 4 | █ | Y-908R | 4585 | | D-POWER 1 | 7906 |



e kW

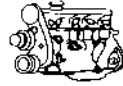

Cyl.

Order-
No. No.LPG/CNG
D-PowerOrder-
No.**FIAT**

| | | | | | | | | | | |
|------------------------------------|-----|-----|---------------|---------------------------------------|---|-----------------|-------|----|------------|-------|
| Ducato TD | 2.5 | 68 | 01.86 - 02.94 | | 4 | Y-908R | 4585 | | D-POWER 1 | 7906 |
| Duna 60 / 60 Weekend | 1.1 | 43 | 10.86 - 12.90 | 146A6 | 4 | 0,8 BPR6ES | 7822 | 2 | LPG 2 | 1497 |
| Duna 70 / 70 Weekend | 1.3 | 48 | 10.86 - 12.90 | 146A5 | 4 | 0,8 BPR6ES | 7822 | 2 | LPG 2 | 1497 |
| Duna DS D | 1.7 | 44 | 10.86 - 12.90 | | 4 | Y-924J | 7906 | | D-POWER 1 | 7906 |
| Fiorino | 1.4 | 51 | 01.93 - | 160.A1.046 | 4 | 0,9 BPR5ES | 7422 | 6 | LPG 2 | 1497 |
| Fiorino | 1.5 | 55 | 01.90 - 08.93 | 149C1.000 Cat. | 4 | 0,8 BPR6ES | 7822 | 2 | LPG 2 | 1497 |
| Fiorino 1.3 MJET 16V | 1.3 | 55 | 10.07 - | 199A2000 | 4 | Y8003J | 97256 | | D-POWER 62 | 97256 |
| Fiorino D | 1.3 | 33 | 03.82 - 10.82 | | 4 | Y-208T | 1250 | | | |
| Fiorino D | 1.3 | 33 | 11.82 - 12.87 | | 4 | Y-924J | 7906 | | D-POWER 1 | 7906 |
| Fiorino D | 1.3 | 33 | 06.90 - 08.93 | 146 B1.000 | 4 | Y-924J | 7906 | | D-POWER 1 | 7906 |
| Fiorino D | 1.7 | 42 | 01.88 - | 149 B4.046 | 4 | Y-924J | 7906 | | D-POWER 1 | 7906 |
| Fiorino D | 1.7 | 43 | 12.87 - | 149 B3.000 | 4 | Y-924J | 7906 | | D-POWER 1 | 7906 |
| Grande Punto 1.2 | 1.2 | 48 | 09.05 - | 199A4000 | 4 | 1,0 ZKR7A-10 | 1691 | | ZKR7A-10 | 1691 |
| Grande Punto 1.3 MJET 75CV | 1.3 | 55 | 09.05 - | 199A2000 | 4 | Y8003J | 97256 | | D-POWER 62 | 97256 |
| Grande Punto 1.3 MJET 90CV | 1.3 | 66 | 12.05 - | 199A3000 | 4 | Y8003J | 97256 | | D-POWER 62 | 97256 |
| Grande Punto 1.4 | 1.4 | 57 | 09.05 - | 350A1000 | 4 | 1,0 ZKR7A-10 | 1691 | | ZKR7A-10 | 1691 |
| Grande Punto 1.4 16V | 1.4 | 70 | 09.05 - 08 | 199A6000 | 4 | 1,0 ZKR7A-10 | 1691 | | ZKR7A-10 | 1691 |
| Grande Punto 1.4 GPL | 1.4 | 57 | 02.09 - | | 4 | 1,0 ZKR7A-10 | 1691 | | LPG 8 | |
| Grande Punto 1.4 NATURAL POWER | 1.4 | 57 | 09.08 - | 350A1000 | 4 | 1,0 ZKR7A-10 | 1691 | | ZKR7A-10 | 1691 |
| Grande Punto 1.4 T-JET 16V | 1.4 | 88 | 06.07 - | 198A4000 | 4 | 0,8 IKR9F8 | 5756 | | IKR9F8 | 5756 |
| Idea | 1.4 | 70 | 10.03 - 02.05 | 843A1.000 | 4 | 0,9 DCPR7E-N | 4795 | | DCPR8EIX | 6546 |
| Idea 1.2 16V | 1.2 | 59 | 02.05 - | 188A5.000 | 4 | 1,0 DCPR7E-N-10 | 4983 | | | |
| Idea 1.3 MJET 16V 70CV | 1.3 | 51 | 06.03 - | 188A9000 | 4 | Y8003J | 97256 | | D-POWER 62 | 97256 |
| Idea 1.3 MJET 16V 90CV | 1.3 | 66 | 11.05 - | 199A3000 | 4 | Y8003J | 97256 | | D-POWER 62 | 97256 |
| Idea 1.4 | 1.4 | 57 | 09.05 - | 350A1.000 | 4 | 1,0 ZKR7A-10 | 1691 | | ZKR7A-10 | 1691 |
| Idea 1.4 16V | 1.4 | 70 | 02.05 - | 843A1.000 | 4 | 1,0 DCPR7E-N-10 | 4983 | | | |
| Idea 1.4 GPL | 1.4 | 57 | 03.09 - | 350A1000 | 4 | 1,0 ZKR7A-10 | 1691 | | LPG 8 | |
| Idea 1.9 MJT | 1.9 | 74 | 10.03 - | 188B2000 | 4 | Y-534J | 3413 | | D-POWER 36 | 3413 |
| Marea | 1.9 | 55 | 09.96 - 12.00 | 182 A8.000 | 4 | Y-928U | 4389 | | D-POWER 29 | 4389 |
| Marea | 1.9 | 74 | 09.96 - 12.00 | 182 A7.000 | 4 | Y-928U | 4389 | | D-POWER 29 | 4389 |
| Marea | 2.4 | 91 | 09.96 - 12.00 | 185 A2.000 | 5 | Y-928U | 4389 | | D-POWER 29 | 4389 |
| Marea i. 16 V, Weekend | 1.8 | 83 | 09.96 - 11.98 | 182A2.000 | 4 | BKR6EKC | 2848 | 26 | LPG 1 | 1496 |
| Marea i. 16V Sx Bipower | 1.6 | 76 | 11.97 - 12.03 | 182A4.000 | 4 | BKR6EKC | 2848 | 26 | LPG 1 | 1496 |
| Marea / Marengo JTD | 1.9 | 77 | 04.99 - 11.99 | 182B4000 fino a n.motore —>1713819 | 4 | Y-747U | 4694 | | D-POWER 26 | 4694 |
| Marea / Marengo JTD | 1.9 | 81 | 01.02 - | 186A6000 | 4 | Y-534J | 3413 | | D-POWER 36 | 3413 |
| Marea 100 16V,Sx,Elx,Aut., Weekend | 1.6 | 76 | 12.98 - 12.03 | 182A4.000 | 4 | 0,9 BKR5EZ | 7642 | 36 | LPG 1 | 1496 |
| Marea 115 16V; Weekend | 1.8 | 83 | 12.99 - 01.01 | 182A2.000 | 4 | BKR6EKC | 2848 | 26 | LPG 1 | 1496 |
| Marea 16V Sx,Elx,Aut., Weekend | 1.6 | 76 | 05.98 - 11.98 | 182A4.000 | 4 | 0,9 BKR5EZ | 7642 | 36 | LPG 1 | 1496 |
| Marea 20V | 2.0 | 108 | 09.96 - 11.98 | 182 A1.000 | 5 | BKR6EKC | 2848 | 26 | LPG 1 | 1496 |
| Marea 80 16V Sx,Hsx; Weekend | 1.2 | 60 | 12.98 - 12.00 | 182B2.000 | 4 | 0,9 DCPR8E-N | 5692 | | | |
| Marea i. 16V; Weekend | 1.6 | 76 | 09.96 - 04.98 | 182A4.000 | 4 | BKR6EKC | 2848 | 26 | LPG 1 | 1496 |
| Marea i.;80 16V ,Weekend | 1.2 | 59 | 03.98 - 05.99 | 182B2.000 | 4 | DCPR8EKC | 7168 | | | |
| Marea JTD | 1.9 | 74 | 01.01 - 12.01 | 182B9000 | 4 | Y-534J | 3413 | | D-POWER 36 | 3413 |
| Marea JTD | 1.9 | 77 | 12.99 - 01.01 | 182B4000 dal n.motore 1713820 —> | 4 | Y-534J | 3413 | | D-POWER 36 | 3413 |
| Marea JTD | 2.4 | 100 | 12.99 - 09.02 | 185A6000 dal n.motore 1713820 —> | 5 | Y-534J | 3413 | | D-POWER 36 | 3413 |
| Marea JTD | 2.4 | 100 | 03.99 - 11.99 | 185A6000 fino a n.motore —>1713819 | 5 | Y-747U | 4694 | | D-POWER 26 | 4694 |
| Marengo D | 1.9 | 48 | 01.92 - | 160 A 7.000 | 4 | Y-924J | 7906 | | D-POWER 1 | 7906 |
| Marengo D | 1.9 | 66 | 01.92 - | 160 A 6.000 | 4 | Y-924J | 7906 | | D-POWER 1 | 7906 |



ℓ kW



Cyl.

Order-
No.VLINE
No.LPG/CNG
D-PowerOrder-
No.

| FIAT | | | | | | | | | | | |
|--------------------------------|------|----|-------------|-------------------------|---|-----|-------------|-------|----|------------|-------|
| Marengo D | 2.0 | 48 | 01.86-07.89 | | 4 | █ | Y-924J | 7906 | | D-POWER 1 | 7906 |
| Marengo D | 2.5 | 53 | 05.80-07.89 | 8144.61 | 4 | █ | Y-208T | 1250 | | | |
| Marengo JTD | 1.9 | 77 | 12.99-12.01 | 182B4000 dal | 4 | █ | Y-534J | 3413 | | D-POWER 36 | 3413 |
| | | | | n.motore 1713820 → | | | | | | | |
| Marengo TD | 1.9 | 66 | 01.92- | 160 A 6.000 | 4 | █ | Y-924J | 7906 | | D-POWER 1 | 7906 |
| Multipla JTD | 1.9 | 77 | 11.98-11.99 | 182B4000 fino a | 4 | █ | Y-747U | 4694 | | D-POWER 26 | 4694 |
| | | | | n. motore →1692991 | | | | | | | |
| Multipla JTD | 1.9 | 77 | 12.99-02.01 | 82B4000 dal | 4 | █ | Y-534J | 3413 | | D-POWER 36 | 3413 |
| | | | | n. motore →1692992 | | | | | | | |
| Multipla JTD | 1.9 | 81 | 02.01-07.02 | 186A6000 | 4 | █ | Y-534J | 3413 | | D-POWER 36 | 3413 |
| Multipla JTD | 1.9 | 85 | 07.02-09.05 | 186A8000 | 4 | █ | Y-534J | 3413 | | D-POWER 36 | 3413 |
| Multipla 1.6 16V | 1.6 | 76 | 09.04- | 182B6.000 | 4 | 0,9 | BKR5EZ | 7642 | 36 | LPG 1 | 1496 |
| Multipla 1.6 16V NATURAL POWER | 1.6 | 76 | 09.04- | 182B4.000 | 4 | | BKR6EKC | 2848 | 26 | LPG 1 | 1496 |
| Multipla 100 16V Bipower | 1.6 | 76 | 01.99-12.04 | 186 A4.000 | 4 | | BKR6EKC | 2848 | 26 | LPG 1 | 1496 |
| Multipla 100 16V Bluepower | 1.6 | 70 | 01.99-12.04 | 186.A3.000 | 4 | | BKR6EKC | 2848 | 26 | LPG 1 | 1496 |
| Multipla 100 16V Sx | 1.6 | 76 | 01.99-06.99 | 186 A4.000 | 4 | | BKR6EKC | 2848 | 26 | LPG 1 | 1496 |
| Multipla 100 16V Sx | 1.6 | 76 | 07.99-12.04 | 186 A4.000 | 4 | 0,9 | BKR5EZ | 7642 | 36 | LPG 1 | 1496 |
| Palio 16V | 1.2 | 59 | 09.01-11.02 | 188 A5.000 | 4 | 0,9 | DCPR8E-N | 5692 | | | |
| Palio 16V | 1.2 | 59 | 12.02- | 188 A5.000 | 4 | 0,9 | DCPR7E-N | 4795 | | DCPR8EIX | 6546 |
| Palio 1,9 D | 1.9 | 46 | 01- | 223A6,000 | 4 | █ | Y-939J | 5059 | | D-POWER 43 | 5059 |
| Palio 1.4L | 1.4 | 51 | 09.97- | 178 B2.000 | 4 | 0,9 | BKR5EZ | 7642 | 36 | LPG 1 | 1496 |
| Palio 1.6L 16V | 1.6 | 74 | 96-06.99 | 182B6.000 | 4 | | BKR6EKC | 2848 | 26 | LPG 1 | 1496 |
| Palio 100 16V Weekend | 1.6 | 76 | 07.99- | 178B3.000 | 4 | 0,9 | BKR5EZ | 7642 | 36 | LPG 1 | 1496 |
| Palio 100 16V Weekend | 1.6 | 76 | 11.97-06.99 | 178B3.000 | 4 | | BKR6EKC | 2848 | 26 | LPG 1 | 1496 |
| Palio 65 1.2L | 1.2 | 50 | 01.00-12.00 | 178 E2.000 | 4 | | BKR6EKC | 2848 | 26 | LPG 1 | 1496 |
| Palio 75 Weekend | 1.2 | 54 | 11.97-12.00 | 178B5.000 | 4 | | BKR6EKC | 2848 | 26 | LPG 1 | 1496 |
| Palio 8V | 1.2 | 44 | 01.01- | 188A4.000 | 4 | 0,9 | BKR5EZ | 7642 | 36 | LPG 1 | 1496 |
| Palio TD | 1.7 | 51 | 97- | | 4 | █ | Y-922R | 4356 | | D-POWER 1 | 7906 |
| Panda | 1.1 | 40 | 09.00- | 187A1.000 | 4 | 0,9 | BKR5EZ | 7642 | 36 | LPG 1 | 1496 |
| Panda | 1.0 | 33 | 01.86-07.89 | 156A2.146/246 | 4 | 0,8 | BCPR6ES | 2330 | 12 | LPG 3 | 1498 |
| Panda | 1.1 | 40 | 09.03-12.04 | 187A1.000 | 4 | 0,9 | BKR5EZ | 7642 | 36 | LPG 1 | 1496 |
| Panda - 1.0 L- young-L- CLX | 1.0 | 33 | 06.94-12.97 | 141C2.000 | 4 | 0,8 | BPR6ES | 7822 | 2 | LPG 2 | 1497 |
| Panda 1100 Selecta Van | 1.1 | 40 | 01.97-08.00 | 176B2.000 | 4 | | BKR6EKC | 2848 | 26 | LPG 1 | 1496 |
| Panda 4X4 | 1.1 | 40 | 01.96-08.00 | 156C046 | 4 | 0,8 | BCPR6ES | 2330 | 12 | LPG 3 | 1498 |
| Panda / Panda 4x4 1.3 MJT 16V | 1.3 | 51 | 09.03- | 188A8000 | 4 | █ | Y8003J | 97256 | | D-POWER 62 | 97256 |
| Panda 1.2 / Panda 1.2 4x4 | 1.2 | 44 | 10.04- | 188A4.000 | 4 | 1,0 | DCPR7E-N-10 | 4983 | | | |
| Panda 1.2 GPL | 1.2 | 44 | 02.09- | | 4 | 1,0 | DCPR7E-N-10 | 4983 | | LPG 8 | |
| Panda 1.2 Natural Power | 1.2 | 44 | 06.06- | 188A4.000 | 4 | 1,0 | DCPR7E-N-10 | 4983 | | | |
| Panda 1.4 16V 100 HP | 1.4 | 74 | 06.07- | 169A3000 | 4 | 1,0 | DCPR7E-N-10 | 4983 | | | |
| Panda 1000 | 1.0 | 32 | 01.86-04.96 | 156A2.048-156A2.146/246 | 4 | 0,8 | BCPR6ES | 2330 | 12 | LPG 3 | 1498 |
| Panda 1100 | 1.1 | 40 | 02.95-12.96 | 176B2.000 | 4 | 0,8 | BCPR6ES | 2330 | 12 | LPG 3 | 1498 |
| Panda 1100 Selecta | 1.1 | 37 | 07.90-12.96 | 156C.046 Cat. | 4 | 0,8 | BCPR6ES | 2330 | 12 | LPG 3 | 1498 |
| Panda 30 L/ 30 CL / 30 S | 0.65 | 22 | 03.80-12.85 | 141AE... | 2 | 0,6 | BPR7HS | 6422 | | BPR8HIX | 6742 |
| Panda 34 | 0.85 | 25 | 02.81-12.85 | M 020 BS | 4 | 0,8 | BPR6ES | 7822 | 2 | LPG 2 | 1497 |
| Panda 45 / 45 S / 4x4 | 0.9 | 33 | -12.96 | 146A.. | 4 | 0,8 | BPR6ES | 7822 | 2 | LPG 2 | 1497 |
| Panda 4x4 | 0.95 | 35 | 09.83-12.85 | A112 B1 | 4 | 0,8 | BPR6ES | 7822 | 2 | LPG 2 | 1497 |
| Panda 4x4 | 1.1 | 40 | 02.95-12.96 | 176B2.000 | 4 | 0,8 | BCPR6ES | 2330 | 12 | LPG 3 | 1498 |
| Panda 750 CLX -CL-L- Fire | 0.75 | 24 | 01.86-12.96 | 156A... | 4 | 0,8 | BCPR6ES | 2330 | 12 | LPG 3 | 1498 |
| Panda 750 Young | 0.75 | 25 | 01.86-12.96 | 141B000 | 4 | 0,8 | BPR6ES | 7822 | 2 | LPG 2 | 1497 |
| Panda 900 | 0.9 | 29 | -12.96 | 1170A1.046 | 4 | 0,8 | BPR6ES | 7822 | 2 | LPG 2 | 1497 |
| Panda 900- Jolly-Van | 0.9 | 29 | 01.97-01.01 | 1170 A1.046 | 4 | 0,9 | BKR5EZ | 7642 | 36 | LPG 1 | 1496 |
| Panda D | 1.3 | 27 | 03.86-12.89 | 156A 5.000 | 4 | █ | Y-924J | 7906 | | D-POWER 1 | 7906 |



ℓ kW

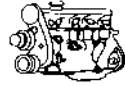

Cyl.

Order-
No. No.LPG/CNG
D-PowerOrder-
No.**FIAT**

| | | | | | | | | | | | |
|------------------------------------|-----|----|--------------|-----------------------|---|-----|-------------|-------|----|------------|-------|
| Panda Eco | 1.1 | 40 | 12.04 - | 187A1.000 | 4 | 1,0 | DCPR7E-N-10 | 4983 | | | |
| Panda i. | 0.9 | 29 | 01.96 -01.01 | | 4 | 0,8 | BPR6ES | 7822 | 2 | LPG 2 | 1497 |
| Panda Van | 1.0 | 33 | 01.97 - | 141C2.000 | 4 | | BKR6EKC | 2848 | 26 | LPG 1 | 1496 |
| Panda VAN 1.3 MJT 16V | 1.3 | 51 | 09.03 - | 188A9000 | 4 | █ | Y8003J | 97256 | | D-POWER 62 | 97256 |
| Punto 1,8 HGT | 1.8 | 96 | 09.00 -08.02 | 188 A1.000 | 4 | | BKR6EKC | 2848 | 26 | LPG 1 | 1496 |
| Punto 1,8 HGT | 1.8 | 96 | 09.02 - | 188 A1.000 | 4 | 0,9 | BKR6EZ | 4619 | 38 | LPG 1 | 1496 |
| Punto 55 | 1.1 | 40 | 11.93 -05.97 | 176A6.000 | 4 | 0,8 | BCPR6ES | 2330 | 12 | LPG 3 | 1498 |
| Punto 55 S | 1.1 | 40 | 06.94 -05.97 | 176A6.000 | 4 | 0,8 | BCPR6ES | 2330 | 12 | LPG 3 | 1498 |
| Punto 55 S; Sx; 6 Speed | 1.1 | 40 | 06.97 -09.99 | 176B2.000 | 4 | 0,8 | BCPR6ES | 2330 | 12 | LPG 3 | 1498 |
| Punto 60 Cabrio S | 1.2 | 40 | 06.97 -06.98 | 176 B2.000 | 4 | 0,8 | BCPR6ES | 2330 | 12 | LPG 3 | 1498 |
| Punto 60 S; Sx; Selecta | 1.2 | 44 | 06.97 -09.99 | 176B4.000 | 4 | 0,8 | BCPR6ES | 2330 | 12 | LPG 3 | 1498 |
| Punto 70 TD | 1.7 | 53 | 10.96 -12.99 | | 4 | █ | Y-928U | 4389 | | D-POWER 29 | 4389 |
| Punto 75 | 1.2 | 54 | 11.93 -05.98 | 176A8.000 | 4 | 0,8 | BCPR6ES | 2330 | 12 | LPG 3 | 1498 |
| Punto 90 | 1.6 | 65 | 01.94 -05.97 | 176A9.000 | 4 | 0,9 | BCPR7ES | 3330 | | BCPR7EIX | 5690 |
| Punto 90 Cabrio ELX | 1.6 | 65 | 06.94 -05.98 | 176A9.000 | 4 | 0,9 | BCPR7ES | 3330 | | BCPR7EIX | 5690 |
| Punto SPI | 1.2 | 44 | 11.93 -05.97 | 176B1.000 | 4 | 0,8 | BCPR6ES | 2330 | 12 | LPG 3 | 1498 |
| Punto 1.2L 16V | 1.2 | 59 | 09.00 -11.02 | 188A5.000 | 4 | 0,9 | DCPR8E-N | 5692 | | | |
| Punto 1.2L 16V | 1.2 | 59 | 12.02 -02.05 | 188A5.000 | 4 | 0,9 | DCPR7E-N | 4795 | | DCPR8EIX | 6546 |
| Punto 1.2L 8V | 1.2 | 44 | 09.00 -10.04 | 188A4.000 | 4 | 0,9 | BKR5EZ | 7642 | 36 | LPG 1 | 1496 |
| Punto 1.4L 16V | 1.4 | 70 | 06.03 - | 843 A1.000 | 4 | 0,9 | DCPR7E-N | 4795 | | DCPR8EIX | 6546 |
| Punto 1.9 DS | 1.9 | 44 | 09.99 - 03 | 188A3.000 | 4 | █ | Y-939J | 5059 | | D-POWER 43 | 5059 |
| Punto 16V | 1.2 | 59 | 02.05 - | 188A5.000 | 4 | 1,0 | DCPR7E-N-10 | 4983 | | | |
| Punto 16V 1.2L Cabrio | 1.2 | 63 | 06.97 -06.01 | 176 B9.000 | 4 | 0,9 | DCPR8E | 4339 | | DCPR9EIX | 2316 |
| Punto 60 - SPI- Cabrio-Selecta | 1.2 | 43 | 06.94 -05.98 | 176A7.000 | 4 | 0,8 | BCPR6ES | 2330 | 12 | LPG 3 | 1498 |
| Punto 85 16V 1.2L | 1.2 | 63 | 05.97 -09.01 | 176B9.000 | 4 | 0,9 | DCPR8E | 4339 | | DCPR9EIX | 2316 |
| Punto Cabrio 1.2L | 1.2 | 44 | 06.98 -02.01 | 176B4.000 | 4 | 0,8 | BCPR6ES | 2330 | 12 | LPG 3 | 1498 |
| Punto Cabrio 1.2L 16V | 1.2 | 63 | 06.98 -02.01 | 176B9.000 | 4 | 0,9 | DCPR8E | 4339 | | DCPR9EIX | 2316 |
| Punto Classic 1.2 | 1.2 | 44 | 10.04 - | 188A4.000 | 4 | 1,0 | DCPR7E-N-10 | 4983 | | | |
| Punto Classic 1.3 MJET 16V | 1.3 | 51 | 12.03 - | 188A9000 | 4 | █ | Y8003J | 97256 | | D-POWER 62 | 97256 |
| Punto Classic Natural Power | 1.2 | 44 | 02.05 - | 188A4000 | 4 | 1,0 | DCPR7E-N-10 | 4983 | | | |
| Punto D | 1.7 | 42 | 11.94 - | 176 A 3.000 | 4 | █ | Y-924J | 7906 | | D-POWER 1 | 7906 |
| PUNTO EVO 1,3 MJT 75CV | 1.3 | 55 | 09.09 - | 199A2000 | 4 | █ | Y8003J | 97256 | | D-POWER 62 | 97256 |
| PUNTO EVO 1,4 MULTIAIR 16V | 1.4 | 77 | 09.09 - | | 4 | 1,0 | DCPR7E-N-10 | 4983 | | | |
| PUNTO EVO 1,4 MULTIAIR TURBO 135CV | 1.4 | 99 | 09.09 - | | 4 | 0,8 | IKR9F8 | 5756 | | IKR9F8 | 5756 |
| PUNTO EVO 1.2 | 1.2 | 48 | 09.09 - | 199A4000 | 4 | 1,0 | ZKR7A-10 | 1691 | | ZKR7A-10 | 1691 |
| PUNTO EVO 1.3 MJT 90CV | 1.3 | 66 | 09.09 - | 199A3000 | 4 | █ | Y8003J | 97256 | | D-POWER 62 | 97256 |
| PUNTO EVO 1.4 | 1.4 | 57 | 09.09 - | 350A1000 | 4 | 1,0 | ZKR7A-10 | 1691 | | ZKR7A-10 | 1691 |
| PUNTO EVO 1.4 NATURAL POWER | 1.4 | 57 | 09.09 - | 350A1000 | 4 | 1,0 | ZKR7A-10 | 1691 | | ZKR7A-10 | 1691 |
| Punto JTD | 1.9 | 59 | 10.99 -12.00 | 188A2000 | 4 | █ | Y-534J | 3413 | | D-POWER 36 | 3413 |
| Punto JTD | 1.9 | 63 | 01.01 -06.03 | 188A7000 | 4 | █ | Y-534J | 3413 | | D-POWER 36 | 3413 |
| Punto Natural Power | 1.2 | 44 | 01.04 -10.04 | 188A4.000 | 4 | 0,9 | BKR5EZ | 7642 | 36 | LPG 1 | 1496 |
| Punto S, SX, ELX TD | 1.7 | 53 | 06.93 -09.96 | 176 TD, 1697 TT | 4 | █ | Y-922R | 4356 | | D-POWER 1 | 7906 |
| Punto S, SX,ELX TD | 1.7 | 53 | 10.96 -12.99 | | 4 | █ | Y-928U | 4389 | | D-POWER 29 | 4389 |
| Punto Sporting | 1.6 | 65 | 07.95 -05.97 | 176A9.000 | 4 | 0,9 | BCPR7ES | 3330 | | BCPR7EIX | 5690 |
| Punto Turbo GT | 1.4 | 96 | 06.93 -09.99 | 176 B6.000/ 176A4.000 | 4 | | BCPR6ET | 2197 | | LPG 3 | 1498 |
| Punto Van | 1.1 | 40 | 06.97 -06.00 | 176B2.000 | 4 | 0,8 | BCPR6ES | 2330 | 12 | LPG 3 | 1498 |
| Qubo 1.3 MJET 16V 75CV | 1.3 | 55 | 10.07 - | 199A2000 | 4 | █ | Y8003J | 97256 | | D-POWER 62 | 97256 |
| Regata 100 IE S / IE Riv. | 1.6 | 74 | 06.86 -07.89 | 149C3.000 | 4 | 0,8 | BPR6ES | 7822 | 2 | LPG 2 | 1497 |
| Regata 100 IE Week./Riv./S | 1.6 | 74 | 06.86 -06.90 | 149A4.. | 4 | 0,8 | BPR6ES | 7822 | 2 | LPG 2 | 1497 |
| Regata 100 S / Weekend | 1.6 | 74 | 06.86 -06.90 | 149A4.. | 4 | 0,8 | BPR7ES | 2023 | 19 | BPR8EIX | 6684 |
| Regata 70 | 1.3 | 48 | 09.83 -07.89 | 149A7.000 | 4 | 0,8 | BPR6ES | 7822 | 2 | LPG 2 | 1497 |
| Regata 75 IE | 1.5 | 55 | 02.87 -06.90 | 149C1.000 | 4 | 0,8 | BPR7ES | 2023 | 19 | BPR8EIX | 6684 |



ℓ kW



Cyl.

Order-
No.LPG/CNG
D-PowerOrder-
No.

| FIAT | ℓ | kW | Calendar | Engine | Cyl. | Injection | Order- No. | V-Line | LPG/CNG D-Power | Order- No. | |
|------------------------------------|-----|-----|---------------|----------------------|------|-----------|---------------|--------|--------------------|---------------|-------|
| Regata 85 S | 1.5 | 62 | 01.84 - 12.87 | 149A.000 | 4 | 0,8 | BPR7ES | 2023 | 19 | BPR8EIX | 6684 |
| Regata 90 IE | 1.6 | 66 | 01.87 - 03.89 | 149C2.000 Cat. | 4 | 0,8 | BPR6ES | 7822 | 2 | LPG 2 | 1497 |
| Regata D | 1.7 | 43 | 06.87 - | | 4 | Y-924J | 7906 | | | D-POWER 1 | 7906 |
| Regata D | 1.7 | 43 | 09.83 - 05.87 | 138 B., 149 B 3. | 4 | Y-924J | 7906 | | | D-POWER 1 | 7906 |
| Regata D | 1.9 | 48 | 06.87 - | | 4 | Y-924J | 7906 | | | D-POWER 1 | 7906 |
| Regata D | 1.9 | 48 | 04.84 - 05.87 | 149 A 1. | 4 | Y-924J | 7906 | | | D-POWER 1 | 7906 |
| Regata TD | 1.9 | 59 | 06.86 - 07.89 | | 4 | Y-924J | 7906 | | | D-POWER 1 | 7906 |
| Ritmo 100 S / S Team | 1.6 | 74 | 05.85 - 12.87 | 149A4.. | 4 | 0,8 | BPR6ES | 7822 | 2 | LPG 2 | 1497 |
| Ritmo 105 TC | 1.6 | 77 | 10.82 - 04.85 | 138AR.. | 4 | 0,8 | BPR6ES | 7822 | 2 | LPG 2 | 1497 |
| Ritmo 130 TC Abarth | 2.0 | 96 | 04.83 - 12.87 | 138AR2.. | 4 | 0,8 | BPR7ES | 2023 | 19 | BPR8EIX | 6684 |
| Ritmo 70 S / S Team | 1.3 | 48 | 05.85 - 12.87 | 138B2.., 149A7.. | 4 | 0,8 | BPR6ES | 7822 | 2 | LPG 2 | 1497 |
| Ritmo 75 Super | 1.3 | 55 | 01.81 - 09.82 | 138AE.. | 4 | 0,8 | BPR7ES | 2023 | 19 | BPR8EIX | 6684 |
| Ritmo 85 S | 1.5 | 61 | 01.81 - 12.87 | 138AE, 138B3, 149A.. | 4 | 0,8 | BPR7ES | 2023 | 19 | BPR8EIX | 6684 |
| Ritmo D | 1.7 | 43 | 10.82 - | | 4 | Y-924J | 7906 | | | D-POWER 1 | 7906 |
| Ritmo TD | 1.9 | 59 | 12.85 - 12.87 | 831 D 1. | 4 | Y-924J | 7906 | | | D-POWER 1 | 7906 |
| Scudo | 1.6 | 58 | 02.96 - | 220A2.000 | 4 | 0,8 | BCPR7ES | 3330 | | BCPR7EIX | 5690 |
| Scudo | 1.9 | | 09.98 - | DW8, DW8TD, WJZ | 4 | Y-503R | 4279 | | | D-POWER 10 | 1009 |
| Scudo | 1.9 | | 09.98 - | XUD9TF | 4 | Y-938R | 5267 | | | D-POWER 1 | 7906 |
| Scudo | 2.0 | 100 | 11.06 - | RHR | 4 | Y1005J | 7957 | | | D-POWER 56 | 7957 |
| Scudo | 2.0 | 88 | 11.06 - | RHG | 4 | Y1005J | 7957 | | | D-POWER 56 | 7957 |
| Scudo | 2.0 | 88 | 11.06 - | RHK | 4 | Y1005J | 7957 | | | D-POWER 56 | 7957 |
| Scudo D | 1.9 | 51 | 03.96 - | | 4 | Y-923U | 3380 | | | D-POWER 1 | 7906 |
| Scudo TD | 1.9 | 68 | 03.96 - | | 4 | Y-923U | 3380 | | | D-POWER 1 | 7906 |
| Sedici 1.6 16V 107CV | 1.6 | 79 | 09.05 - | M16A | 4 | 1,1 | IFR6J11 | 7658 | | IFR6J11 | 7658 |
| Sedici 1.9 MJET | 1.9 | 88 | 01.06 - | D19AA | 4 | Y-534J | 3413 | | | D-POWER 36 | 3413 |
| Seicento Sporting | 1.1 | 40 | 03.98 - 09.00 | 176B2.000 | 4 | 0,8 | BCPR6ES | 2330 | 12 | LPG 3 | 1498 |
| Seicento 1.1 | 1.1 | 40 | 10.04 - | 187A1.000 | 4 | 1,0 | DCPR7E-N-10 | 4983 | | | |
| Seicento 1100 | 1.1 | 40 | 05.98 - 09.00 | 176B2.000 | 4 | 0,8 | BCPR6ES | 2330 | 12 | LPG 3 | 1498 |
| Seicento 1100 | 1.1 | 40 | 10.00 - 10.04 | 187A1000 | 4 | 0,9 | BKR5EZ | 7642 | 36 | LPG 1 | 1496 |
| Seicento 900 i.e. S; SX; Citymatic | 0.9 | 29 | 05.98 - 12.00 | 1170A1.046 | 4 | 0,8 | BPR6ES | 7822 | 2 | LPG 2 | 1497 |
| Siena 1.4 | 1.4 | 51 | 11.97 - | 178 B2.000 | 4 | 0,9 | BKR5EZ | 7642 | 36 | LPG 1 | 1496 |
| Stilo 1.2 16V | 1.2 | 59 | 09.01 - 11.02 | 188.A5000 | 4 | 0,9 | DCPR8E-N | 5692 | | | |
| Stilo 1.2 16V | 1.2 | 59 | 12.02 - 06.04 | 188.A5000 | 4 | 0,9 | DCPR7E-N | 4795 | | DCPR8EIX | 6546 |
| Stilo 1.4 16 V / SW | 1.4 | 70 | 02.05 - | 843A1.000 | 4 | 1,0 | DCPR7E-N-10 | 4983 | | | |
| Stilo 1.4 16V / SW | 1.4 | 70 | 01.04 - 02.05 | 843.A1000 | 4 | 0,9 | DCPR7E-N | 4795 | | DCPR8EIX | 6546 |
| Stilo 1.6 | 1.6 | 76 | 09.01 - 05.06 | 182.B6000 | 4 | 0,9 | BKR5EZ | 7642 | 36 | LPG 1 | 1496 |
| Stilo 1.6 SW | 1.6 | 76 | 09.02 - | 182.B6000 | 4 | 0,9 | BKR5EZ | 7642 | 36 | LPG 1 | 1496 |
| Stilo 1.8 16V | 1.8 | 96 | 09.01 - | 192.A4000 | 4 | 0,9 | BKR6EZ | 4619 | 38 | LPG 1 | 1496 |
| Stilo 1.8 SW | 1.8 | 98 | 09.02 - | 192.A4000 | 4 | 0,9 | BKR6EZ | 4619 | 38 | LPG 1 | 1496 |
| Stilo 1.9 JTD | 1.9 | 59 | 09.01 - 08.04 | 192A3000 | 4 | Y-534J | 3413 | | | D-POWER 36 | 3413 |
| Stilo 1.9 JTD | 1.9 | 74 | 09.04 - 07.05 | 192A9000 | 4 | Y-534J | 3413 | | | D-POWER 36 | 3413 |
| Stilo 1.9 JTD | 1.9 | 85 | 09.01 - 07.05 | 192A1000 | 4 | Y-534J | 3413 | | | D-POWER 36 | 3413 |
| Stilo 1.9 MJ 16V | 1.9 | 103 | 01.04 - 09.05 | 192A5000 | 4 | YE07 | 6092 | | | | |
| Stilo 1.9 MJ 16V | 1.9 | 110 | 09.05 - 10.07 | 937A5000 | 4 | YE07 | 6092 | | | | |
| Stilo 2.4 20V | 2.4 | 125 | 09.01 - | 192.A2000 | 5 | 0,9 | BKR6EZ | 4619 | 38 | LPG 1 | 1496 |
| Strada | 1.2 | 48 | 10.04 - | 178B7.045 | 4 | 1,0 | DCPR7E-N-10 | 4983 | | | |
| Strada | 1.2 | | 01.99 - 10.05 | 188A4.000 | 4 | 0,9 | BKR5EZ | 7642 | 36 | LPG 1 | 1496 |
| Strada | 1.6 | | 10.99 - 10.04 | 178D2011 | 4 | 0,9 | BKR5EZ | 7642 | 36 | LPG 1 | 1496 |
| Strada 1.3 MJET 16V | 1.3 | 63 | 05.06 - | 223A9000 | 4 | Y8003J | 97256 | | | D-POWER 62 | 97256 |
| Strada 1.7 D | 1.7 | 51 | 06.99 - | 176A3000 | 4 | Y-924J | 7906 | | | D-POWER 1 | 7906 |
| Strada 1.9 D | 1.9 | 46 | 12.00 - 03.03 | 223A6000 | 4 | Y-939J | 5059 | | | D-POWER 43 | 5059 |
| Strada 1.9 JTD | 1.9 | 59 | 04.03 - 06.05 | 188A2000 | 4 | Y-534J | 3413 | | | D-POWER 36 | 3413 |



ℓ kW

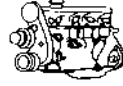

Cyl.

Order-
No. No.LPG/CNG
D-PowerOrder-
No.**FIAT**

| | | | | | | | | | | | |
|------------------------------|-----|-----|---------------|------------------------|---|-----|---------|------|----|------------|------|
| Strada 75 | 1.2 | 54 | 05.99 - 05 | 178B5.000 | 4 | 0,9 | BKR5EZ | 7642 | 36 | LPG 1 | 1496 |
| Talento D | 1.9 | 51 | 03.88 - | | 4 | █ | Y-924J | 7906 | | D-POWER 1 | 7906 |
| Tempra 1.6 | 1.6 | 55 | 02.90 - 12.94 | 159 A3.048 | 4 | 0,8 | BPR7ES | 2023 | 19 | BPR8EIX | 6684 |
| Tempra 1800 i.e/a.Modelle | 1.8 | 77 | 02.90 - 10.96 | 159A4.046 | 4 | 0,8 | BPR7ES | 2023 | 19 | BPR8EIX | 6684 |
| Tempra / SX / Sta. Wagon | 1.4 | 56 | 03.90 - 10.96 | 159A2.000 | 4 | 0,8 | BPR6ES | 7822 | 2 | LPG 2 | 1497 |
| Tempra 1.4- S.W- .S | 1.4 | 51 | 10.94 - 10.96 | 836A4.000 | 4 | 0,8 | BPR6ES | 7822 | 2 | LPG 2 | 1497 |
| Tempra 1.6 | 1.6 | 55 | 09.94 - 10.96 | 835C1.000 | 4 | 0,9 | BCPR7ES | 3330 | | BCPR7EIX | 5690 |
| Tempra 1.6 90CV-Liberty S.W. | 1.6 | 66 | 03.95 - | | 4 | 0,9 | BCPR7ES | 3330 | | BCPR7EIX | 5690 |
| Tempra 2.0L | 2.0 | 83 | 02.90 - 10.96 | 159A6.046 | 4 | 0,8 | BPR7ES | 2023 | 19 | BPR8EIX | 6684 |
| Tempra D - SW | 1.9 | 48 | 02.90 - 06.96 | 160 A7.000 | 4 | █ | Y-924J | 7906 | | D-POWER 1 | 7906 |
| Tempra ie SX, S.W. | 1.8 | 74 | 05.95 - | | 4 | 0,8 | BPR7ES | 2023 | 19 | BPR8EIX | 6684 |
| Tempra TD | 1.9 | 59 | 07.90 - | 160 B6.046 | 4 | █ | Y-924J | 7906 | | D-POWER 1 | 7906 |
| Tempra TD | 1.9 | 68 | 06.93 - 09.96 | 160 D1.000 | 4 | █ | Y-922R | 4356 | | D-POWER 1 | 7906 |
| Tempra TD /SW | 1.9 | 66 | 02.90 - | 160 A6.000 | 4 | █ | Y-924J | 7906 | | D-POWER 1 | 7906 |
| Tipo | 1.4 | 51 | 07.87 - 11.90 | 160 A1.046 | 4 | 0,8 | BPR6ES | 7822 | 2 | LPG 2 | 1497 |
| Tipo | 1.4 | 57 | 01.90 - 05.95 | 159A2.000 | 4 | 0,8 | BPR6ES | 7822 | 2 | LPG 2 | 1497 |
| Tipo | 1.6 | 60 | 02.88 - 06.90 | 160A2.000 | 4 | 0,8 | BPR7ES | 2023 | 19 | BPR8EIX | 6684 |
| Tipo | 1.6 | 63 | 04.90 - 12.92 | 159A3.000 DOHC | 4 | 0,8 | BPR7ES | 2023 | 19 | BPR8EIX | 6684 |
| Tipo | 1.6 | 63 | 07.87 - 03.90 | 160A2.000 | 4 | 0,8 | BPR7ES | 2023 | 19 | BPR8EIX | 6684 |
| Tipo 1.1L | 1.1 | 41 | 07.87 - 03.93 | 160A3.000 | 4 | 0,8 | BCPR6ES | 2330 | 12 | LPG 3 | 1498 |
| Tipo Selecta | 1.4 | 53 | 02.88 - | 160A1.000 | 4 | 0,8 | BPR6ES | 7822 | 2 | LPG 2 | 1497 |
| Tipo Selecta | 1.6 | 57 | 01.92 - 03.93 | 159A3.046 | 4 | 0,8 | BPR7ES | 2023 | 19 | BPR8EIX | 6684 |
| Tipo 1.6L | 1.6 | 55 | 03.93 - 10.94 | 835C1.000 | 4 | 0,9 | BCPR7ES | 3330 | | BCPR7EIX | 5690 |
| Tipo 2.0 L | 2.0 | 83 | 03.90 - 03.92 | 159A6.046 | 4 | 0,8 | BPR7ES | 2023 | 19 | BPR8EIX | 6684 |
| Tipo 2.0 L- GT / SLX | 2.0 | 83 | 11.91 - 10.95 | 159A6.046 Cat. | 4 | 0,8 | BPR7ES | 2023 | 19 | BPR8EIX | 6684 |
| Tipo D | 1.7 | 42 | 07.87 - 03.93 | 149 B 4.000 | 4 | █ | Y-924J | 7906 | | D-POWER 1 | 7906 |
| Tipo D | 1.9 | 48 | 07.89 - 03.93 | 149 A1.000 | 4 | █ | Y-924J | 7906 | | D-POWER 1 | 7906 |
| Tipo i.e | 1.6 | 66 | 02.88 - 06.90 | 160A1.000 | 4 | 0,8 | BPR7ES | 2023 | 19 | BPR8EIX | 6684 |
| Tipo i.e. | 1.6 | 55 | 03.94 - | | 4 | 0,9 | BCPR7ES | 3330 | | BCPR7EIX | 5690 |
| Tipo i.e. | 1.6 | 55 | 03.93 - 10.95 | 835C1.000 | 4 | 0,8 | BPR7ES | 2023 | 19 | BPR8EIX | 6684 |
| Tipo i.e. | 1.6 | 66 | 03.93 - 10.95 | 159 A3.048 | 4 | 0,8 | BPR7ES | 2023 | 19 | BPR8EIX | 6684 |
| Tipo i.e. GT | 1.8 | 80 | 03.92 - 03.93 | 139A4.000 | 4 | 0,8 | BPR7ES | 2023 | 19 | BPR8EIX | 6684 |
| Tipo i.e. 16V | 2.0 | 109 | 05.91 - 10.95 | 160A8.046 | 4 | 0,8 | BPR7ES | 2023 | 19 | BPR8EIX | 6684 |
| Tipo IE 16V | 1.8 | 80 | 06.89 - 05.90 | 159A4.000 | 4 | 0,8 | BPR7ES | 2023 | 19 | BPR8EIX | 6684 |
| Tipo IE 16V | 1.8 | 102 | 06.89 - 09.91 | 160A5.000 | 4 | | BP6ET | 1263 | | LPG 2 | 1497 |
| Tipo IE 16V | 2.0 | 102 | 05.91 - 10.95 | 836A3.000 Cat. | 4 | 0,8 | BPR7ES | 2023 | 19 | BPR8EIX | 6684 |
| Tipo IE SX / GT / SLX | 1.8 | 76 | 11.91 - 10.95 | 835C2.000 | 4 | 0,8 | BPR7ES | 2023 | 19 | BPR8EIX | 6684 |
| Tipo TD | 1.9 | 66 | 07.87 - | 160 D1.000 | 4 | █ | Y-924J | 7906 | | D-POWER 1 | 7906 |
| Tipo TD | 1.9 | 68 | 06.93 - 12.94 | | 4 | █ | Y-922R | 4356 | | D-POWER 1 | 7906 |
| Tipo TD | 1.9 | 68 | 07.87 - 03.93 | 149 A 1.000 | 4 | █ | Y-924J | 7906 | | D-POWER 1 | 7906 |
| Tipo1.4L | 1.4 | 51 | 02.88 - 11.90 | 160A1.000 | 4 | 0,8 | BPR7ES | 2023 | 19 | BPR8EIX | 6684 |
| Ulysse | 2.0 | 100 | 09.00 - 08.02 | RFN | 4 | 0,9 | LFR5B | 7113 | | LPG 7 | 1640 |
| Ulysse | 2.0 | 100 | 05.06 - | RHR | 4 | █ | Y1005J | 7957 | | D-POWER 56 | 7957 |
| Ulysse | 2.0 | 80 | 06.03 - | RHM | 4 | █ | Y1005J | 7957 | | D-POWER 56 | 7957 |
| Ulysse | 2.0 | 81 | 06.02 - 07.06 | RHW | 4 | █ | Y1005J | 7957 | | D-POWER 56 | 7957 |
| Ulysse | 2.0 | 88 | 05.06 - | RHK | 4 | █ | Y1005J | 7957 | | D-POWER 56 | 7957 |
| Ulysse | 2.2 | 96 | 06.02 - 07.07 | 4H01 | 4 | █ | Y1005J | 7957 | | D-POWER 56 | 7957 |
| Ulysse | 2.2 | 96 | 06.02 - 07.07 | 4HW | 4 | █ | Y1005J | 7957 | | D-POWER 56 | 7957 |
| Ulysse 2.0 JTD | 2.0 | 80 | 09.02 - 05.03 | RHW (DW10ATED4) | 4 | █ | Y-504R | 4359 | | D-POWER 24 | 1441 |
| | | | | fino a ric. n. —> 9666 | | | | | | | |
| Ulysse i.S | 2.0 | 89 | 07.94 - | RFU | 4 | | BKR5EK | 7956 | 23 | LPG 1 | 1496 |
| Ulysse i.turbo | 2.0 | 108 | 07.94 - 12.98 | RGX | 4 | | BKR6EK | 2288 | 20 | BKR6EQUIP | 3199 |



ℓ kW

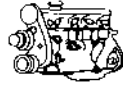

Cyl.

Order-
No. No.LPG/CNG
D-PowerOrder-
No.**FIAT**

| | | | | | | | | | | | |
|---------------------------|-----|-----|--------------|-------------------|---|-----|---------|------|----|------------|------|
| Ulysse JTD | 2.0 | 80 | 09.02 - | DW10ATED4/RHT | 4 | █ | Y-504R | 4359 | | D-POWER 24 | 1441 |
| Ulysse JTD | 2.2 | 94 | 09.02 - | DW12ATED4/4HW | 4 | █ | Y-504R | 4359 | | D-POWER 24 | 1441 |
| Ulysse TD | 1.9 | 68 | 09.94 - | XUD 9 TU | 4 | █ | Y-923U | 3380 | | D-POWER 1 | 7906 |
| Ulysse TD | 2.1 | 80 | 07.96 - | XUD11ATE | 4 | █ | Y-923U | 3380 | | D-POWER 1 | 7906 |
| Uno 1.0 L | 1.0 | 35 | 08.94 - | | 4 | 0,8 | BPR6ES | 7822 | 2 | LPG 2 | 1497 |
| Uno 1.0L- Start | 1.0 | 33 | 08.94 -10.95 | 156A2.000-2.048 | 4 | 0,9 | BPR5ES | 7422 | 6 | LPG 2 | 1497 |
| Uno 45 | 1.0 | 32 | 06.85 -10.95 | 156A2... | 4 | 0,8 | BCPR6ES | 2330 | 12 | LPG 3 | 1498 |
| Uno 45 D | 1.3 | 33 | 06.83 -08.89 | 127 A 5. | 4 | █ | Y-924J | 7906 | | D-POWER 1 | 7906 |
| Uno 45 ES/S/Sting/Trend | 0.9 | 33 | 01.83 -10.95 | 146A... | 4 | 0,8 | BPR6ES | 7822 | 2 | LPG 2 | 1497 |
| Uno 55 / 55 S | 1.1 | 41 | 01.83 -04.85 | 138B.. | 4 | 0,8 | BPR6ES | 7822 | 2 | LPG 2 | 1497 |
| Uno 60 /60 CS / 60 S | 1.1 | 43 | 05.85 -08.89 | 146A4... | 4 | 0,8 | BPR6ES | 7822 | 2 | LPG 2 | 1497 |
| Uno 60 D | 1.3 | 33 | 06.83 -08.89 | 127 A 5. | 4 | █ | Y-924J | 7906 | | D-POWER 1 | 7906 |
| Uno 60 D | 1.7 | 40 | 09.89 -09.92 | 146 B 2.000 | 4 | █ | Y-924J | 7906 | | D-POWER 1 | 7906 |
| Uno 60 D | 1.7 | 44 | 07.86 -08.89 | 149 B 3. | 4 | █ | Y-924J | 7906 | | D-POWER 1 | 7906 |
| Uno 60 IE / S | 1.1 | 37 | 07.91 -10.95 | 156C.046 Cat. | 4 | 0,8 | BCPR6ES | 2330 | 12 | LPG 3 | 1498 |
| Uno 60 S / SX / Fire | 1.1 | 41 | 05.85 -10.95 | 146A6.000 | 4 | 0,8 | BCPR6ES | 2330 | 12 | LPG 3 | 1498 |
| Uno 60 SL / Trend | 1.1 | 41 | 09.89 -09.92 | 146A6.000 | 4 | 0,8 | BPR6ES | 7822 | 2 | LPG 2 | 1497 |
| Uno 60 TD | 1.4 | 51 | 03.86 -09.92 | 146 B | 4 | █ | Y-924J | 7906 | | D-POWER 1 | 7906 |
| Uno 70 all models | 1.4 | 51 | 83 -10.95 | 160A1.046 | 4 | 0,8 | BPR6ES | 7822 | 2 | LPG 2 | 1497 |
| Uno 70 S / SL / SX | 1.3 | 48 | 05.85 -09.89 | 149A7... | 4 | 0,8 | BPR6ES | 7822 | 2 | LPG 2 | 1497 |
| Uno 70 TD | 1.4 | 51 | 03.86 -08.89 | 146 A 653, 146 B. | 4 | █ | Y-924J | 7906 | | D-POWER 1 | 7906 |
| Uno 75 I.E. SPI | 1.5 | 55 | 12.87 -10.95 | 149C1.000 | 4 | 0,8 | BPR6ES | 7822 | 2 | LPG 2 | 1497 |
| Uno 75 IE SX / Selecta | 1.5 | 55 | 10.85 -08.87 | 138C2... Cat. | 4 | 0,8 | BPR7ES | 2023 | 19 | BPR8EIX | 6684 |
| Uno D | 1.7 | | 01.91 - | | 4 | █ | Y-924J | 7906 | | D-POWER 1 | 7906 |
| Uno D | 1.7 | | 10.89 - | | 4 | █ | Y-924J | 7906 | | D-POWER 1 | 7906 |
| Uno D Van | 1.7 | 42 | 09.89 -03.96 | 146 B2.000 | 4 | █ | Y-924J | 7906 | | D-POWER 1 | 7906 |
| Uno i.e. | 1.4 | 51 | 08.94 - | | 4 | 0,8 | BPR6ES | 7822 | 2 | LPG 2 | 1497 |
| Uno Selecta / Selecta S | 1.1 | 43 | 04.87 -08.89 | 146A4.048 | 4 | 0,8 | BPR6ES | 7822 | 2 | LPG 2 | 1497 |
| Uno TD | 1.4 | 52 | 09.89 -12.95 | 146 B3.000 | 4 | █ | Y-924J | 7906 | | D-POWER 1 | 7906 |
| Uno Turbo i.e. | 1.3 | 73 | 04.85 -08.89 | 146A2... Cat. | 4 | | BCPR7ET | 2164 | | BCPR7EIX | 5690 |
| Uno Turbo IE/ Racing | 1.4 | 82 | 09.89 -12.93 | 146A8.046 Cat. | 4 | | BCPR7ET | 2164 | | BCPR7EIX | 5690 |
| Marea i. 12 V; Weekend | 1.4 | 55 | 10.96 -02.98 | 182A3.000 | 4 | | BKR6EKC | 2848 | 26 | LPG 1 | 1496 |
| Marea i. 155 20 V Weekend | 2.0 | 108 | 10.96 -12.03 | 182 A1.000 | 5 | | BKR6EKC | 2848 | 26 | LPG 1 | 1496 |

FISSORE

| | | | | | | | | | | | |
|----------------|-----|-----|--------------|---------------|---|-----|--------|------|---|-----------|------|
| Magnum 4x4 TD | 2.4 | 77 | 07.84 -04.86 | | 6 | █ | Y-908R | 4585 | | D-POWER 1 | 7906 |
| Magnum Volumex | 2.0 | 102 | 01.86 -03.88 | 132E.000 Fiat | 4 | 0,8 | BPR6ES | 7822 | 2 | LPG 2 | 1497 |
| Rayton | 3.5 | 155 | 03.88 - | | 6 | 0,7 | BP6ES | 7811 | 4 | LPG 2 | 1497 |
| Rayton 4x4 TD | 2.4 | 82 | 03.88 - | HR 492 HIM | 6 | █ | Y-909R | 4602 | | | |
| Vip V6 i.e. | 2.5 | 118 | 03.86 -03.88 | 019.11 Alfa | 6 | 0,7 | BP6ES | 7811 | 4 | LPG 2 | 1497 |

FORD

| | | | | | | | | | | | |
|-------------|-----|-----|--------------|----------------------|---|-----|----------|------|----|----------|------|
| Aerostar | 3.0 | | | | 6 | 0,9 | BPR6EFS | 3623 | 7 | LPG 5 | 1516 |
| Capri | 1.3 | 42 | 06.81 -08.82 | Kent1VHC/2VHC | 4 | 0,8 | BCPR7ES | 3330 | | BCPR7EIX | 5690 |
| Capri | 2.8 | 118 | 01.81 -04.87 | FIHC V6 | 6 | 0,8 | BPR7ES | 2023 | 19 | BPR8EIX | 6684 |
| Capri Turbo | 2.8 | 138 | 01.81 -04.83 | Turbo V6 | 6 | 0,7 | BR8EVX | 1262 | | BR9EIX | 3981 |
| Cougar | 2.0 | 96 | 08.98 -01.01 | EDBA ZETEC-E SEFI | 4 | 1,3 | PTR5A-13 | 2467 | 25 | LPG 4 | 1511 |
| Cougar | 2.0 | 96 | 08.98 -01.01 | EDBB ZETEC-E SEFI | 4 | 1,3 | PTR5A-13 | 2467 | 25 | LPG 4 | 1511 |
| Cougar | 2.0 | 96 | 08.98 -01.01 | EDBC ZETEC-E SEFI | 4 | 1,3 | PTR5A-13 | 2467 | 25 | LPG 4 | 1511 |
| Cougar | 2.0 | 96 | 08.98 -01.01 | EDBD ZETEC-E SEFI | 4 | 1,3 | PTR5A-13 | 2467 | 25 | LPG 4 | 1511 |
| Cougar | 2.5 | 125 | 08.98 -01.01 | LCBA Duratec VE SEFI | 6 | 1,0 | PTR5D-10 | 3784 | 31 | LPG 5 | 1516 |
| Cougar | 2.5 | 125 | 08.98 -01.01 | LCBB Duratec-VE SEFI | 6 | 1,0 | PTR5D-10 | 3784 | 31 | LPG 5 | 1516 |



ℓ kW



Cyl.

Order-
No. No.LPG/CNG
D-PowerOrder-
No.**FORD**

| | | | | | | | | | | | |
|---------------------------|-----|-----|---------------|----------------------|---|-----|------------|------|----|-----------|------|
| Cougar | 2.5 | 125 | 08.98 - 01.01 | LCBC Duratec VE SEFI | 6 | 1,0 | PTR5D-10 | 3784 | 31 | LPG 5 | 1516 |
| Cougar | 2.5 | 125 | 08.98 - 01.01 | LCBE Duratec-VE SEFI | 6 | 1,0 | PTR5D-10 | 3784 | 31 | LPG 5 | 1516 |
| Cougar | 2.5 | 151 | 08.98 - 01.01 | MABB Duratec VE SEFI | 6 | 1,0 | PTR5D-10 | 3784 | 31 | LPG 5 | 1516 |
| Courier D | 1.8 | 66 | 03.93 - | | 4 | █ | Y-910R | 4751 | | D-POWER 3 | 3617 |
| Econovan | 1.4 | 48 | 09.85 - | UC OHC/E 2V | 4 | 0,8 | BPR6ES | 7822 | 2 | LPG 2 | 1497 |
| Econovan | 2.0 | 41 | 09.85 - | RF | 4 | █ | Y-107R | 1229 | | | |
| Escort '81 | 1.1 | 37 | 08.80 - 12.85 | GSE VAL VV | 4 | 1,0 | BPR6EFS | 3623 | 7 | LPG 5 | 1516 |
| Escort '81 | 1.1 | 40 | 08.80 - 12.85 | GLB VAL VV | 4 | 1,0 | BPR6EFS | 3623 | 7 | LPG 5 | 1516 |
| Escort '81 | 1.1 | 40 | 08.80 - 12.85 | GMA CVH VV | 4 | 0,8 | BCPR6ES | 2330 | 12 | LPG 3 | 1498 |
| Escort '81 | 1.1 | 43 | 08.80 - 12.85 | GPA CVH VV | 4 | 0,8 | BCPR7ES | 3330 | | BCPR7EIX | 5690 |
| Escort '81 | 1.3 | 43 | 08.80 - 12.85 | JGA CHT 2V | 4 | 0,8 | BCPR6ES | 2330 | 12 | LPG 3 | 1498 |
| Escort '81 | 1.3 | 51 | 08.80 - 12.85 | JPA CVH VV | 4 | 0,8 | BCPR6ES | 2330 | 12 | LPG 3 | 1498 |
| Escort '81 | 1.6 | 40 | 08.80 - 12.85 | LTA | 4 | █ | Y-907R | 4479 | | | |
| Escort '81 | 1.6 | 48 | 08.80 - 12.85 | LGA CHT 2V | 4 | 0,8 | BCPR6ES | 2330 | 12 | LPG 3 | 1498 |
| Escort '81 | 1.6 | 58 | 08.80 - 12.85 | LPA CVH VV | 4 | 0,8 | BCPR7ES | 3330 | | BCPR7EIX | 5690 |
| Escort '81 | 1.6 | 58 | 08.80 - 12.85 | LPI CVH VV | 4 | 0,8 | BCPR7ES | 3330 | | BCPR7EIX | 5690 |
| Escort '81 | 1.6 | 66 | 08.80 - 12.85 | L4B CVH FI | 4 | 0,8 | BCPR6ES | 2330 | 12 | LPG 3 | 1498 |
| Escort '81 | 1.6 | 71 | 08.80 - 12.85 | LUA CVH 2V | 4 | 0,8 | BCPR7ES | 3330 | | BCPR7EIX | 5690 |
| Escort '81 | 1.6 | 77 | 08.80 - 12.85 | LRA CVH FI | 4 | 0,8 | BCPR7ES | 3330 | | BCPR7EIX | 5690 |
| Escort '81 | 1.6 | 77 | 08.80 - 12.85 | LRI CVH FI | 4 | 0,8 | BCPR7ES | 3330 | | BCPR7EIX | 5690 |
| Escort '81 | 1.6 | 85 | 08.80 - 12.85 | LUAE CVH FI | 4 | 0,8 | BCPR9ES-11 | 1152 | | | |
| Escort '81 | 1.6 | 97 | 08.80 - 12.85 | LNA CVH FI | 4 | 0,8 | BCR8ES | 5430 | | | |
| Escort '81 Express Van 55 | 1.6 | 40 | 04.84 - 07.90 | LTA | 4 | █ | Y-907R | 4479 | | | |
| Escort '86 | 1.1 | 37 | 01.86 - 07.90 | GSG VAL VV | 4 | 1,0 | BPR6EFS | 3623 | 7 | LPG 5 | 1516 |
| Escort '86 | 1.1 | 40 | 01.86 - 07.90 | GUC HCS 2V | 4 | 1,0 | BPR6EFS | 3623 | 7 | LPG 5 | 1516 |
| Escort '86 | 1.3 | 44 | 01.86 - 07.90 | JBB HCS 2V | 4 | 1,0 | BPR6EFS | 3623 | 7 | LPG 5 | 1516 |
| Escort '86 | 1.3 | 44 | 01.86 - 07.90 | JLA VAL VV | 4 | 1,0 | BPR6EFS | 3623 | 7 | LPG 5 | 1516 |
| Escort '86 | 1.3 | 44 | 01.86 - 07.90 | JLA VAL VV Cat. | 4 | 1,0 | BPR6EFS | 3623 | 7 | LPG 5 | 1516 |
| Escort '86 | 1.3 | 44 | 01.86 - 07.90 | JLB VAL VV | 4 | 1,0 | BPR6EFS | 3623 | 7 | LPG 5 | 1516 |
| Escort '86 | 1.3 | 46 | 01.86 - 07.90 | JBA HCS 2V | 4 | 1,0 | BPR6EFS | 3623 | 7 | LPG 5 | 1516 |
| Escort '86 | 1.4 | 51 | 01.86 - 07.90 | FUAA CVH 2V | 4 | 0,8 | BCPR6ES | 2330 | 12 | LPG 3 | 1498 |
| Escort '86 | 1.4 | 54 | 01.86 - 07.90 | F6B CVH CFI | 4 | 1,1 | BCPR6ES-11 | 7121 | 11 | LPG 3 | 1498 |
| Escort '86 | 1.4 | 54 | 01.86 - 07.90 | F6D CVH CFI | 4 | 1,1 | BCPR6ES-11 | 7121 | 11 | LPG 3 | 1498 |
| Escort '86 | 1.4 | 54 | 01.86 - 07.90 | FUC CVH 2V | 4 | 1,1 | BCPR7ES-11 | 1095 | | BCPR7EIX | 5690 |
| Escort '86 | 1.4 | 55 | 01.86 - 07.90 | FUA CVH 2V | 4 | 0,8 | BCPR6ES | 2330 | 12 | LPG 3 | 1498 |
| Escort '86 | 1.4 | 55 | 01.86 - 07.90 | FUA CVH 2V Cat. | 4 | 0,8 | BCPR6ES | 2330 | 12 | LPG 3 | 1498 |
| Escort '86 | 1.6 | 40 | 01.86 - 07.90 | LTC | 4 | █ | Y-907R | 4479 | | | |
| Escort '86 | 1.6 | 58 | 01.86 - 07.90 | LP2 CVH VV | 4 | 0,8 | BCPR6ES | 2330 | 12 | LPG 3 | 1498 |
| Escort '86 | 1.6 | 65 | 01.86 - 07.90 | LUG CVH 2V | 4 | 0,8 | BCPR6ES | 2330 | 12 | LPG 3 | 1498 |
| Escort '86 | 1.6 | 66 | 01.86 - 07.90 | L4B CVH FI | 4 | 0,8 | BCPR6ES | 2330 | 12 | LPG 3 | 1498 |
| Escort '86 | 1.6 | 66 | 01.86 - 07.90 | LUC CVH 2V | 4 | 0,8 | BCPR6ES | 2330 | 12 | LPG 3 | 1498 |
| Escort '86 | 1.6 | 66 | 01.86 - 07.90 | LUC CVH 2V Cat. | 4 | 0,8 | BCPR6ES | 2330 | 12 | LPG 3 | 1498 |
| Escort '86 | 1.6 | 75 | 01.86 - 07.90 | LJB CVH EFI | 4 | 1,1 | BCPR6ES-11 | 7121 | 11 | LPG 3 | 1498 |
| Escort '86 | 1.6 | 77 | 01.86 - 07.90 | LR2 CVH FI | 4 | 0,8 | BCPR7ES | 3330 | | BCPR7EIX | 5690 |
| Escort '86 | 1.6 | 77 | 01.86 - 07.90 | LRB CVH FI | 4 | 0,8 | BCPR7ES | 3330 | | BCPR7EIX | 5690 |
| Escort '86 | 1.6 | 77 | 01.86 - 07.90 | LRB CVH FI Cat. | 4 | 0,8 | BCPR7ES | 3330 | | BCPR7EIX | 5690 |
| Escort '86 | 1.6 | 79 | 01.86 - 07.90 | LJA CVH EFI | 4 | 1,1 | BCPR6ES-11 | 7121 | 11 | LPG 3 | 1498 |
| Escort '86 | 1.6 | 97 | 01.86 - 07.90 | LNB CVH FI | 4 | 0,8 | BCR8ES | 5430 | | | |
| Escort '86 | 1.8 | 44 | 01.86 - 07.90 | RTA | 4 | █ | Y-910R | 4751 | | D-POWER 3 | 3617 |
| Escort '86 | 1.8 | 44 | 01.86 - 07.90 | RTB | 4 | █ | Y-910R | 4751 | | D-POWER 3 | 3617 |
| Escort '91 | 1.1 | 40 | 08.90 - 09.01 | GUF HCS 2V | 4 | 1,0 | PTR5D-10 | 3784 | 31 | LPG 5 | 1516 |
| Escort '91 | 1.3 | 44 | 08.90 - 09.01 | J4B Endura-E SEFI | 4 | 1,0 | PTR5D-10 | 3784 | 31 | LPG 5 | 1516 |



ℓ kW

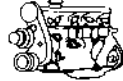

Cyl.

Order-
No.VLINE
No.LPG/CNG
D-PowerOrder-
No.**FORD**

| | | | | | | | | | | | |
|---------------------|------|-----|---------------|---------------------------|---|-----|------------|------|----|------------|------|
| Escort '91 | 1.3 | 44 | 08.90 - 09.01 | J6A HCS CFI | 4 | 1,0 | PTR5D-10 | 3784 | 31 | LPG 5 | 1516 |
| Escort '91 | 1.3 | 44 | 08.90 - 09.01 | JBE HCS 2V | 4 | 1,0 | PTR5D-10 | 3784 | 31 | LPG 5 | 1516 |
| Escort '91 | 1.3 | 46 | 08.90 - 09.01 | JBD HCS 2V | 4 | 1,0 | PTR5D-10 | 3784 | 31 | LPG 5 | 1516 |
| Escort '91 | 1.4 | 52 | 08.90 - 09.01 | F6F CVH CFI | 4 | 1,1 | BCPR6ES-11 | 7121 | 11 | LPG 3 | 1498 |
| Escort '91 | 1.4 | 52 | 08.90 - 09.01 | F6G CVH CFI | 4 | 1,1 | BCPR6ES-11 | 7121 | 11 | LPG 3 | 1498 |
| Escort '91 | 1.4 | 54 | 08.90 - 09.01 | F4B PTE SEFI | 4 | 1,1 | BCPR6ES-11 | 7121 | 11 | LPG 3 | 1498 |
| Escort '91 | 1.4 | 54 | 08.90 - 09.01 | FUH CVH 2V | 4 | 0,8 | BCPR6ES | 2330 | 12 | LPG 3 | 1498 |
| Escort '91 | 1.6 | 65 | 08.90 - 09.01 | L1H ZETEC-E SEFI | 4 | 1,3 | PTR5A-13 | 2467 | 25 | LPG 4 | 1511 |
| Escort '91 | 1.6 | 66 | 08.90 - 09.01 | L1E ZETEC-E SEFI | 4 | 1,3 | PTR5A-13 | 2467 | 25 | LPG 4 | 1511 |
| Escort '91 | 1.6 | 66 | 08.90 - 09.01 | L1K ZETEC-E SEFI | 4 | 1,3 | PTR5A-13 | 2467 | 25 | LPG 4 | 1511 |
| Escort '91 | 1.6 | 66 | 08.90 - 09.01 | LUJ CVH 2V | 4 | 0,8 | BCPR6ES | 2330 | 12 | LPG 3 | 1498 |
| Escort '91 | 1.6 | 66 | 08.90 - 09.01 | LUK CVH 2V | 4 | 0,8 | BCPR6ES | 2330 | 12 | LPG 3 | 1498 |
| Escort '91 | 1.6 | 77 | 08.90 - 09.01 | LJF CVH EFI | 4 | 1,1 | BCPR6ES-11 | 7121 | 11 | LPG 3 | 1498 |
| Escort '91 | 1.6 | 79 | 08.90 - 09.01 | LJE CVH EFI | 4 | 1,1 | BCPR6ES-11 | 7121 | 11 | LPG 3 | 1498 |
| Escort '91 | 1.8 | 44 | 08.90 - 09.01 | RTE | 4 | █ | Y-910R | 4751 | | D-POWER 3 | 3617 |
| Escort '91 | 1.8 | 44 | 08.90 - 09.01 | RTF | 4 | █ | Y-910R | 4751 | | D-POWER 3 | 3617 |
| Escort '91 | 1.8 | 44 | 08.90 - 09.01 | RTH | 4 | █ | Y-910R | 4751 | | D-POWER 3 | 3617 |
| Escort '91 | 1.8 | 66 | 08.90 - 09.01 | RFD | 4 | █ | Y-910R | 4751 | | D-POWER 3 | 3617 |
| Escort '91 | 1.8 | 66 | 08.90 - 09.01 | RFK | 4 | █ | Y-910R | 4751 | | D-POWER 3 | 3617 |
| Escort '91 | 1.8 | 66 | 08.90 - 09.01 | RFS Endura-DE (TC) | 4 | █ | Y-937J | 5148 | | D-POWER 5 | 7503 |
| Escort '91 | 1.8 | 77 | 08.90 - 09.01 | RDA ZETEC SEFI | 4 | 1,3 | PTR5A-13 | 2467 | 25 | LPG 4 | 1511 |
| Escort '91 | 1.8 | 85 | 08.90 - 09.01 | RKC ZETEC-E SEFI | 4 | 1,3 | PTR5A-13 | 2467 | 25 | LPG 4 | 1511 |
| Escort '91 | 1.8 | 96 | 08.90 - 09.01 | RQB ZETEC SEFI | 4 | 1,3 | PTR5A-13 | 2467 | 25 | LPG 4 | 1511 |
| Escort '91 | 2.0 | 110 | 08.90 - 09.01 | N7A DOHC 16V EFI | 4 | 1,1 | BCPR6ES-11 | 7121 | 11 | LPG 3 | 1498 |
| Escort '91 | 2.0 | 162 | 08.90 - 09.01 | N5F DOHC COSWORTH | 4 | 0,6 | PFR7B | 4853 | | PFR8B | 2781 |
| Escort '91 Cosworth | 2.0 | 162 | 08.90 - 09.01 | N5E DOHC COSWORTH | 4 | 1,1 | PFR7B-11 | 5667 | | PFR8B | 2781 |
| Escort '91 Cosworth | 2.0 | 184 | 92 - | NC8 1711 COSWORTH 16V | 4 | 0,8 | R7234-10 | 5558 | | | |
| Escort '91 TD | 1.8 | 51 | 08.90 - 09.01 | RVA Endura-DE (TC) | 4 | █ | Y-937J | 5148 | | D-POWER 5 | 7503 |
| Explorer | 4.0 | 115 | 01.93 - 03 | V6 SEFI | 6 | 1,5 | TR55 | 1048 | | LPG 5 | 1516 |
| Explorer | 4.0 | 121 | 01.93 - 03 | V6 EFI | 6 | 1,5 | TR55 | 1048 | | LPG 5 | 1516 |
| Explorer | 4.0 | 152 | 01.93 - 03 | V6 SOHC SEFI | 6 | 1,5 | TR55 | 1048 | | LPG 5 | 1516 |
| Explorer | 5.0 | | 01.97 - 01 | V8 | 8 | 1,5 | TR55 | 1048 | | LPG 5 | 1516 |
| Fiesta '01 | 1.25 | 51 | 11.01 - | M7JA Duratec 16V SFI | 4 | 1,3 | PTR5A-13 | 2467 | 25 | LPG 4 | 1511 |
| Fiesta '01 | 1.25 | 51 | 11.01 - | M7JB Duratec 16V SFI | 4 | 1,3 | PTR5A-13 | 2467 | 25 | LPG 4 | 1511 |
| Fiesta '01 | 1.25 | 55 | 11.01 - | FUJA Duratec 16V SFI | 4 | 1,3 | PTR5A-13 | 2467 | 25 | LPG 4 | 1511 |
| Fiesta '01 | 1.25 | 55 | 11.01 - | FUJB Duratec 16V SFI | 4 | 1,3 | PTR5A-13 | 2467 | 25 | LPG 4 | 1511 |
| Fiesta '01 | 1.3 | 44 | 11.01 - | BAJA Duratec 8V SFI | 4 | 1,3 | TR5B-13 | 4559 | | LPG 4 | 1511 |
| Fiesta '01 | 1.3 | 51 | 11.01 - | A9JA Duratec 8V SFI | 4 | 1,3 | TR5B-13 | 4559 | | LPG 4 | 1511 |
| Fiesta '01 | 1.3 | 51 | 11.01 - | A9JB Duratec 8V SFI | 4 | 1,3 | TR5B-13 | 4559 | | LPG 4 | 1511 |
| Fiesta '01 | 1.6 | 74 | 11.01 - | FYJB Duratec 16V SFI | 4 | 1,3 | PTR5A-13 | 2467 | 25 | LPG 4 | 1511 |
| Fiesta '01 16V | 1.4 | 59 | 11.01 - | FXJA Duratec 16V SFI | 4 | 1,3 | PTR5A-13 | 2467 | 25 | LPG 4 | 1511 |
| Fiesta '01 16V | 1.4 | 59 | 11.01 - | FXJB Duratec 16V SFI | 4 | 1,3 | PTR5A-13 | 2467 | 25 | LPG 4 | 1511 |
| Fiesta '01 16V | 1.6 | 74 | 11.01 - | FYJA Duratec 16V SFI | 4 | 1,3 | PTR5A-13 | 2467 | 25 | LPG 4 | 1511 |
| Fiesta '01 TDCI | 1.4 | 50 | 01.05 - | F6JA DuraTorq-TDCi | 4 | █ | YE05 | 5207 | | | |
| Fiesta '01 TDCI | 1.4 | 50 | 11.01 - 12.04 | F6JA DuraTorq-TDCi | 4 | █ | YE04 | 1684 | | D-POWER 40 | 1684 |
| Fiesta '01 TDCI | 1.4 | 50 | 01.05 - | F6JB DuraTorq-TDCi | 4 | █ | YE05 | 5207 | | | |
| Fiesta '01 TDCI | 1.4 | 50 | 11.01 - 12.04 | F6JB DuraTorq-TDCi | 4 | █ | YE04 | 1684 | | D-POWER 40 | 1684 |
| Fiesta '01 TDCI | 1.6 | 66 | 03.05 - | HHJA DuraTorq-TDCi | 4 | █ | YE04 | 1684 | | D-POWER 40 | 1684 |
| Fiesta '01 TDCI | 1.6 | 66 | 03.05 - | HHJB DuraTorq-TDCi | 4 | █ | YE04 | 1684 | | D-POWER 40 | 1684 |
| Fiesta '01 ST150 | 2.0 | 110 | 03.05 - | N4JB Duratec-ST (MI4) SFI | 4 | 1,3 | ITR6F13 | 4477 | | LPG 5 | 1516 |
| Fiesta '08 | 1.25 | 44 | 08.08 - | | 4 | | TR5B-13 | 4559 | | LPG 4 | 1511 |
| Fiesta '08 | 1.25 | 60 | 08.08 - | | 4 | | TR5B-13 | 4559 | | LPG 4 | 1511 |



ℓ kW



Cyl.

Order-
No. No.LPG/CNG
D-PowerOrder-
No.**FORD**

| | | | | | | | | | | | |
|-------------|-----|----|---------------|-----------------|---|-----|------------|------|----|----------|------|
| Fiesta '81 | 1.0 | 29 | 08.81 - 07.83 | TKA VAL 1V | 4 | 1,0 | BPR6EFS | 3623 | 7 | LPG 5 | 1516 |
| Fiesta '81 | 1.0 | 29 | 08.81 - 07.83 | TKW VAL VV | 4 | 1,0 | BPR6EFS | 3623 | 7 | LPG 5 | 1516 |
| Fiesta '81 | 1.0 | 33 | 08.81 - 07.83 | TLA VAL 1V | 4 | 1,0 | BPR6EFS | 3623 | 7 | LPG 5 | 1516 |
| Fiesta '81 | 1.1 | 40 | 08.81 - 07.83 | GLW VAL VV | 4 | 1,0 | BPR6EFS | 3623 | 7 | LPG 5 | 1516 |
| Fiesta '81 | 1.3 | 49 | 08.81 - 07.83 | J3E KENT 2V | 4 | 0,8 | BCPR7ES | 3330 | | BCPR7EIX | 5690 |
| Fiesta '81 | 1.6 | 62 | 08.81 - 07.83 | L3E KENT 2V | 4 | 0,8 | BCPR7ES | 3330 | | BCPR7EIX | 5690 |
| Fiesta '81, | 1.1 | 39 | 08.81 - 07.83 | GLA VAL 1V | 4 | 1,0 | BPR6EFS | 3623 | 7 | LPG 5 | 1516 |
| Fiesta '83 | 1.3 | 51 | 08.83 - 01.87 | JPC CVH VV | 4 | 0,8 | BCPR6ES | 2330 | 12 | LPG 3 | 1498 |
| Fiesta '83 | 1.6 | 40 | 08.83 - 01.87 | LTB D | 4 | | Y-907R | 4479 | | | |
| Fiesta '84 | 1.0 | 33 | 08.83 - 01.87 | TKB VAL 1V | 4 | 1,0 | BPR6EFS | 3623 | 7 | LPG 5 | 1516 |
| Fiesta '84 | 1.0 | 33 | 08.83 - 01.87 | TKB VAL 1V Cat. | 4 | 1,0 | BPR6EFS | 3623 | 7 | LPG 5 | 1516 |
| Fiesta '84 | 1.1 | 37 | 08.83 - 01.87 | GLC VAL 1V | 4 | 1,0 | BPR6EFS | 3623 | 7 | LPG 5 | 1516 |
| Fiesta '84 | 1.1 | 37 | 08.83 - 01.87 | GSF VAL VV | 4 | 1,0 | BPR6EFS | 3623 | 7 | LPG 5 | 1516 |
| Fiesta '84 | 1.1 | 37 | 08.83 - 01.87 | GSF VAL VV Cat. | 4 | 1,0 | BPR6EFS | 3623 | 7 | LPG 5 | 1516 |
| Fiesta '84 | 1.1 | 39 | 08.83 - 01.87 | GLI VAL VV | 4 | 1,0 | BPR6EFS | 3623 | 7 | LPG 5 | 1516 |
| Fiesta '84 | 1.1 | 39 | 08.83 - 01.87 | GSI VAL VV | 4 | 1,0 | BPR6EFS | 3623 | 7 | LPG 5 | 1516 |
| Fiesta '84 | 1.1 | 41 | 08.83 - 01.87 | GL VAL 1V | 4 | 1,0 | BPR6EFS | 3623 | 7 | LPG 5 | 1516 |
| Fiesta '84 | 1.4 | 51 | 08.83 - 01.87 | FUBA CVH 2V | 4 | 0,8 | BCPR6ES | 2330 | 12 | LPG 3 | 1498 |
| Fiesta '84 | 1.4 | 55 | 08.83 - 01.87 | FUB CVH 2V | 4 | 0,8 | BCPR6ES | 2330 | 12 | LPG 3 | 1498 |
| Fiesta '84 | 1.4 | 55 | 08.83 - 01.87 | FUB CVH 2V Cat. | 4 | 0,8 | BCPR6ES | 2330 | 12 | LPG 3 | 1498 |
| Fiesta '84 | 1.6 | 58 | 08.83 - 01.87 | LP3 CVH VV | 4 | 0,8 | BCPR7ES | 3330 | | BCPR7EIX | 5690 |
| Fiesta '84 | 1.6 | 71 | 08.83 - 01.87 | LUB CVH 2V | 4 | 0,8 | BCPR7ES | 3330 | | BCPR7EIX | 5690 |
| Fiesta '84 | 1.6 | 71 | 08.83 - 01.87 | LUB CVH 2V Cat. | 4 | 0,8 | BCPR6ES | 2330 | 12 | LPG 3 | 1498 |
| Fiesta '87 | 1.0 | 33 | 02.87 - 02.89 | TKB VAL 1V | 4 | 1,0 | BPR6EFS | 3623 | 7 | LPG 5 | 1516 |
| Fiesta '87 | 1.0 | 33 | 02.87 - 02.89 | TKB VAL 1V Cat. | 4 | 1,0 | BPR6EFS | 3623 | 7 | LPG 5 | 1516 |
| Fiesta '87 | 1.1 | 35 | 02.87 - 02.89 | GUB VAL 2V | 4 | 1,0 | BPR6EFS | 3623 | 7 | LPG 5 | 1516 |
| Fiesta '87 | 1.1 | 36 | 02.87 - 02.89 | GSH VAL VV | 4 | 1,0 | BPR6EFS | 3623 | 7 | LPG 5 | 1516 |
| Fiesta '87 | 1.1 | 37 | 02.87 - 02.89 | GSF VAL VV | 4 | 1,0 | BPR6EFS | 3623 | 7 | LPG 5 | 1516 |
| Fiesta '87 | 1.1 | 37 | 02.87 - 02.89 | GSF VAL VV Cat. | 4 | 1,0 | BPR6EFS | 3623 | 7 | LPG 5 | 1516 |
| Fiesta '87 | 1.1 | 39 | 02.87 - 02.89 | GS1 VAL VV | 4 | 1,0 | BPR6EFS | 3623 | 7 | LPG 5 | 1516 |
| Fiesta '87 | 1.4 | 52 | 02.87 - 02.89 | F6A CVH CFI | 4 | 1,1 | BCPR6ES-11 | 7121 | 11 | LPG 3 | 1498 |
| Fiesta '87 | 1.4 | 52 | 02.87 - 02.89 | F6C CVH CFI | 4 | 1,1 | BCPR6ES-11 | 7121 | 11 | LPG 3 | 1498 |
| Fiesta '87 | 1.4 | 54 | 02.87 - 02.89 | FUD CVH 2V | 4 | 1,1 | BCPR6ES-11 | 7121 | 11 | LPG 3 | 1498 |
| Fiesta '87 | 1.4 | 55 | 02.87 - 02.89 | FUB CVH 2V | 4 | 0,8 | BCPR6ES | 2330 | 12 | LPG 3 | 1498 |
| Fiesta '87 | 1.6 | 40 | 02.87 - 02.89 | LTB D | 4 | | Y-907R | 4479 | | | |
| Fiesta '87 | 1.6 | 58 | 02.87 - 02.89 | LP3 CVH VV | 4 | 0,8 | BCPR7ES | 3330 | | BCPR7EIX | 5690 |
| Fiesta '87 | 1.6 | 70 | 02.87 - 02.89 | LUD CVH 2V | 4 | 0,8 | BCPR6ES | 2330 | 12 | LPG 3 | 1498 |
| Fiesta '87 | 1.6 | 70 | 02.87 - 02.89 | LUD CVH 2V Cat. | 4 | 0,8 | BCPR6ES | 2330 | 12 | LPG 3 | 1498 |
| Fiesta '89 | 1.0 | 33 | 03.89 - 06.96 | TLB HCS 1V | 4 | 1,0 | BPR6EFS | 3623 | 7 | LPG 5 | 1516 |
| Fiesta '89 | 1.1 | 37 | 03.89 - 06.96 | G6A HCS CFI | 4 | 1,0 | BPR6EFS | 3623 | 7 | LPG 5 | 1516 |
| Fiesta '89 | 1.1 | 40 | 03.89 - 06.96 | GUD HCS 2V | 4 | 1,0 | BPR6EFS | 3623 | 7 | LPG 5 | 1516 |
| Fiesta '89 | 1.1 | 40 | 03.89 - 06.96 | GUE HCS 2V | 4 | 1,0 | BPR6EFS | 3623 | 7 | LPG 5 | 1516 |
| Fiesta '89 | 1.3 | 44 | 03.89 - 06.96 | J6B HCS CFI | 4 | 1,0 | BPR6EFS | 3623 | 7 | LPG 5 | 1516 |
| Fiesta '89 | 1.3 | 44 | 03.89 - 06.96 | JBC HCS 2V | 4 | 1,0 | BPR6EFS | 3623 | 7 | LPG 5 | 1516 |
| Fiesta '89 | 1.4 | 52 | 03.89 - 06.96 | F6E CVH CFI | 4 | 1,1 | BCPR6ES-11 | 7121 | 11 | LPG 3 | 1498 |
| Fiesta '89 | 1.4 | 54 | 03.89 - 06.96 | F4A PTE SEFI | 4 | 1,1 | BCPR6ES-11 | 7121 | 11 | LPG 3 | 1498 |
| Fiesta '89 | 1.4 | 54 | 03.89 - 06.96 | FUG CVH 2V | 4 | 1,1 | BCPR6ES-11 | 7121 | 11 | LPG 3 | 1498 |
| Fiesta '89 | 1.4 | 54 | 03.89 - 06.96 | FUJ CVH 2V | 4 | 0,8 | BCPR6ES | 2330 | 12 | LPG 3 | 1498 |
| Fiesta '89 | 1.4 | 55 | 03.89 - 06.96 | FUF CVH 2V | 4 | 0,8 | BCPR6ES | 2330 | 12 | LPG 3 | 1498 |
| Fiesta '89 | 1.6 | 66 | 03.89 - 06.96 | L1G ZETEC SEFI | 4 | 1,3 | PTR5A-13 | 2467 | 25 | LPG 4 | 1511 |
| Fiesta '89 | 1.6 | 66 | 03.89 - 06.96 | LUH CVH 2V | 4 | 0,8 | BCPR6ES | 2330 | 12 | LPG 3 | 1498 |
| Fiesta '89 | 1.6 | 76 | 03.89 - 06.96 | LJD CVH EFI | 4 | 1,1 | BCPR6ES-11 | 7121 | 11 | LPG 3 | 1498 |



ℓ kW

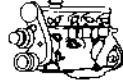

Cyl.

Order-
No.VLINE
No.LPG/CNG
D-PowerOrder-
No.**FORD**

| | | | | | | | | | | | |
|--------------------|------|-----|---------------|-------------------------|---|-----|------------|------|----|------------|------|
| Fiesta '89 | 1.6 | 81 | 03.89 - 06.96 | LJC CVH EFI | 4 | 1,1 | BCPR6ES-11 | 7121 | 11 | LPG 3 | 1498 |
| Fiesta '89 | 1.6 | 96 | 03.89 - 06.96 | LHA CVH Turbo | 4 | 0,8 | BCR8ES | 5430 | | | |
| Fiesta '89 | 1.8 | 44 | 03.89 - 06.96 | RTC D | 4 | ■ | Y-910R | 4751 | | D-POWER 3 | 3617 |
| Fiesta '89 | 1.8 | 44 | 03.89 - 06.96 | RTD D | 4 | ■ | Y-910R | 4751 | | D-POWER 3 | 3617 |
| Fiesta '89 | 1.8 | 44 | 03.89 - 06.96 | RTG D | 4 | ■ | Y-910R | 4751 | | D-POWER 3 | 3617 |
| Fiesta '89 | 1.8 | 77 | 03.89 - 06.96 | RDB ZETEC SEFI | 4 | 1,3 | PTR5A-13 | 2467 | 25 | LPG 4 | 1511 |
| Fiesta '89 | 1.8 | 96 | 03.89 - 06.96 | RQC ZETEC SEFI | 4 | 1,3 | PTR5A-13 | 2467 | 25 | LPG 4 | 1511 |
| Fiesta '96 | 1.25 | 55 | 11.95 - 02.02 | DHA ZETEC-SE SEFI | 4 | 1,3 | PTR5A-13 | 2467 | 25 | LPG 4 | 1511 |
| Fiesta '96 | 1.25 | 55 | 11.95 - 02.02 | DHB ZETEC-SE SEFI | 4 | 1,3 | PTR5A-13 | 2467 | 25 | LPG 4 | 1511 |
| Fiesta '96 | 1.25 | 55 | 11.95 - 02.02 | DHC ZETEC-SE SEFI | 4 | 1,3 | PTR5A-13 | 2467 | 25 | LPG 4 | 1511 |
| Fiesta '96 | 1.25 | 55 | 11.95 - 02.02 | DHD ZETEC-SE SEFI | 4 | 1,3 | PTR5A-13 | 2467 | 25 | LPG 4 | 1511 |
| Fiesta '96 | 1.25 | 55 | 11.95 - 02.02 | DHE ZETEC-SE SEFI | 4 | 1,3 | PTR5A-13 | 2467 | 25 | LPG 4 | 1511 |
| Fiesta '96 | 1.25 | 55 | 11.95 - 02.02 | DHF ZETEC-SE SEFI | 4 | 1,3 | PTR5A-13 | 2467 | 25 | LPG 4 | 1511 |
| Fiesta '96 | 1.25 | 55 | 11.95 - 02.02 | DHG ZETEC-SE SEFI | 4 | 1,3 | PTR5A-13 | 2467 | 25 | LPG 4 | 1511 |
| Fiesta '96 | 1.3 | 37 | 11.95 - 02.02 | JJA Endura-E SEFI | 4 | 1,0 | PTR5D-10 | 3784 | 31 | LPG 5 | 1516 |
| Fiesta '96 | 1.3 | 37 | 11.95 - 02.02 | JJC Endura-E SEFI | 4 | 1,0 | PTR5D-10 | 3784 | 31 | LPG 5 | 1516 |
| Fiesta '96 | 1.3 | 37 | 11.95 - 02.02 | JJE Endura-E SEFI | 4 | 1,0 | PTR5D-10 | 3784 | 31 | LPG 5 | 1516 |
| Fiesta '96 | 1.3 | 37 | 11.95 - 02.02 | JJJ Endura-E SEFI | 4 | 1,0 | PTR5D-10 | 3784 | 31 | LPG 5 | 1516 |
| Fiesta '96 | 1.3 | 37 | 11.95 - 02.02 | JJK Endura-E SEFI | 4 | 1,0 | PTR5D-10 | 3784 | 31 | LPG 5 | 1516 |
| Fiesta '96 | 1.3 | 37 | 11.95 - 02.02 | JJM Endura-E SEFI | 4 | 1,0 | PTR5D-10 | 3784 | 31 | LPG 5 | 1516 |
| Fiesta '96 | 1.3 | 44 | 11.95 - 02.02 | J4C Endura-E SEFI | 4 | 1,0 | PTR5D-10 | 3784 | 31 | LPG 5 | 1516 |
| Fiesta '96 | 1.3 | 44 | 11.95 - 02.02 | J4J Endura-E SEFI | 4 | 1,0 | PTR5D-10 | 3784 | 31 | LPG 5 | 1516 |
| Fiesta '96 | 1.3 | 44 | 11.95 - 02.02 | J4L Endura-E SEFI | 4 | 1,0 | PTR5D-10 | 3784 | 31 | LPG 5 | 1516 |
| Fiesta '96 | 1.3 | 44 | 11.95 - 02.02 | J4Q Endura-E SEFI | 4 | 1,0 | PTR5D-10 | 3784 | 31 | LPG 5 | 1516 |
| Fiesta '96 | 1.3 | 44 | 11.95 - 02.02 | J4R Endura-E SEFI | 4 | 1,0 | PTR5D-10 | 3784 | 31 | LPG 5 | 1516 |
| Fiesta '96 | 1.3 | 44 | 11.95 - 02.02 | J4T Endura-E SEFI | 4 | 1,0 | PTR5D-10 | 3784 | 31 | LPG 5 | 1516 |
| Fiesta '96 | 1.4 | 66 | 11.95 - 02.02 | FHA ZETEC-SE SEFI | 4 | 1,3 | PTR5A-13 | 2467 | 25 | LPG 4 | 1511 |
| Fiesta '96 | 1.4 | 66 | 11.95 - 02.02 | FHE ZETEC-SE SEFI | 4 | 1,3 | PTR5A-13 | 2467 | 25 | LPG 4 | 1511 |
| Fiesta '96 | 1.6 | 76 | 11.95 - 02.02 | L1T ZETEC-SE SEFI | 4 | 1,3 | PTR5A-13 | 2467 | 25 | LPG 4 | 1511 |
| Fiesta '96 | 1.6 | 76 | 11.95 - 02.02 | L1V ZETEC-SE SEFI | 4 | 1,3 | PTR5A-13 | 2467 | 25 | LPG 4 | 1511 |
| Fiesta '96 | 1.8 | 44 | 11.95 - 02.02 | RTJ | 4 | ■ | Y-937J | 5148 | | D-POWER 5 | 7503 |
| Fiesta '96 | 1.8 | 44 | 11.95 - 02.02 | RTK | 4 | ■ | Y-937J | 5148 | | D-POWER 5 | 7503 |
| Focus / C-Max | 1.6 | 74 | 06.03 - | HWDA Duratec-16V SFI | 4 | 1,3 | TR5B-13 | 4559 | | LPG 4 | 1511 |
| Focus / C-Max | 1.6 | 74 | 06.03 - | HWDB Duratec-16V SFI | 4 | 1,3 | TR5B-13 | 4559 | | LPG 4 | 1511 |
| Focus / C-Max | 1.6 | 74 | 06.03 - | SHDA Duratec-HE SFI | 4 | 1,3 | TR5B-13 | 4559 | | LPG 4 | 1511 |
| Focus / C-Max | 1.6 | 74 | 06.03 - | SHDB Duratec-HE SFI | 4 | 1,3 | TR5B-13 | 4559 | | LPG 4 | 1511 |
| Focus / C-Max | 1.6 | 85 | 06.03 - | HXDA Duratec-16V Ti-VCT | 4 | 1,3 | TR5B-13 | 4559 | | LPG 4 | 1511 |
| Focus / C-Max | 1.6 | 85 | 06.03 - | HXDB Duratec-HE SFI | 4 | 1,3 | TR5B-13 | 4559 | | LPG 4 | 1511 |
| Focus / C-Max | 1.8 | 88 | 06.03 - | CSDA Duratec-HE SFI | 4 | 1,3 | ITR6F13 | 4477 | | LPG 5 | 1516 |
| Focus / C-Max | 1.8 | 88 | 06.03 - | CSDB Duratec-HE SFI | 4 | 1,3 | ITR6F13 | 4477 | | LPG 5 | 1516 |
| Focus / C-Max | 1.8 | 92 | 06.03 - | QQDA Duratec-HE SFI | 4 | 1,3 | ITR6F13 | 4477 | | LPG 5 | 1516 |
| Focus / C-Max | 1.8 | 92 | 06.03 - | QQDB Duratec-HE SFI | 4 | 1,3 | ITR6F13 | 4477 | | LPG 5 | 1516 |
| Focus / C-Max | 1.8 | 92 | 06.03 - | QQDC Duratec-HE SFI | 4 | 1,3 | ITR6F13 | 4477 | | LPG 5 | 1516 |
| Focus / C-Max | 2.0 | 107 | 06.03 - | AODA Duratec-HE SFI | 4 | 1,3 | ITR6F13 | 4477 | | LPG 5 | 1516 |
| Focus / C-Max | 2.0 | 107 | 06.03 - | AODB Duratec-HE SFI | 4 | 1,3 | ITR6F13 | 4477 | | LPG 5 | 1516 |
| Focus / C-Max | 2.0 | 107 | 06.03 - | SYDA Duratec-HE SFI | 4 | 1,3 | ITR6F13 | 4477 | | LPG 5 | 1516 |
| Focus / C-Max TDCI | 1.6 | 66 | 06.03 - | HHDA DuraTorq-TDCi | 4 | ■ | YE04 | 1684 | | D-POWER 40 | 1684 |
| Focus / C-Max TDCI | 1.6 | 66 | 06.03 - | HHDB DuraTorq-TDCi | 4 | ■ | YE04 | 1684 | | D-POWER 40 | 1684 |
| Focus / C-Max TDCI | 1.6 | 80 | 06.03 - | G8DA DuraTorq-TDCi | 4 | ■ | YE04 | 1684 | | D-POWER 40 | 1684 |
| Focus / C-Max TDCI | 1.6 | 80 | 06.03 - | G8DB DuraTorq-TDCi | 4 | ■ | YE04 | 1684 | | D-POWER 40 | 1684 |
| Focus / C-Max TDCI | 2.0 | 98 | 06.03 - | G6DC DuraTorq-TDCi | 4 | ■ | Y1005J | 7957 | | D-POWER 56 | 7957 |
| Focus / C-Max TDCI | 2.0 | 98 | 06.03 - | G6DE DuraTorq-TDCi | 4 | ■ | Y1005J | 7957 | | D-POWER 56 | 7957 |



ℓ kW



Cyl.

Order-
No. No.LPG/CNG
D-PowerOrder-
No.**FORD**

| | | | | | | | | | | | |
|-------------------------|-----|-----|---------------|---------------------------|---|-----|----------|------|----|------------|------|
| Focus / C-Max TDCI | 2.0 | 98 | 06.03 - | G6DF DuraTorq-TDCi | 4 | █ | Y1005J | 7957 | | D-POWER 56 | 7957 |
| Focus / C-Max TDCI | 2.0 | 100 | 06.03 - | G6DA DuraTorq-TDCi | 4 | █ | Y1005J | 7957 | | D-POWER 56 | 7957 |
| Focus / C-Max TDCI | 2.0 | 100 | 06.03 - | G6DB DuraTorq-TDCi | 4 | █ | Y1005J | 7957 | | D-POWER 56 | 7957 |
| Focus / C-Max TDCI | 2.0 | 100 | 06.03 - | G6DD DuraTorq-TDCi | 4 | █ | Y1005J | 7957 | | D-POWER 56 | 7957 |
| Focus / C-Max Flexifuel | 1.8 | 92 | 06.03 - | Q7DA Duratec-HE SFI | 4 | 1,3 | ITR6F13 | 4477 | | LPG 5 | 1516 |
| Focus ST | 2.5 | 166 | 12.05 - | HYDA Duratec-ST (V15) SFI | 5 | | PLFR6A | 5472 | | LPG 7 | 1640 |
| Focus '04 | 1.4 | 59 | 07.04 - | ASDA Duratec-16V SFI | 4 | 1,3 | TR5B-13 | 4559 | | LPG 4 | 1511 |
| Focus '04 | 1.4 | 59 | 07.04 - | ASDB Duratec-16V SFI | 4 | 1,3 | TR5B-13 | 4559 | | LPG 4 | 1511 |
| Focus '04 | 1.6 | 66 | 07.04 - | HHDA DuraTorq-TDCi | 4 | █ | YE04 | 1684 | | D-POWER 40 | 1684 |
| Focus '04 | 1.6 | 66 | 07.04 - | HHDB DuraTorq-TDCi | 4 | █ | YE04 | 1684 | | D-POWER 40 | 1684 |
| Focus '04 | 1.6 | 74 | 07.04 - | HWDA Duratec-16V SFI | 4 | 1,3 | TR5B-13 | 4559 | | LPG 4 | 1511 |
| Focus '04 | 1.6 | 74 | 07.04 - | HWDB Duratec-16V SFI | 4 | 1,3 | TR5B-13 | 4559 | | LPG 4 | 1511 |
| Focus '04 | 1.6 | 74 | 07.04 - | SHDA Duratec-16V SFI | 4 | 1,3 | TR5B-13 | 4559 | | LPG 4 | 1511 |
| Focus '04 | 1.6 | 74 | 07.04 - | SHDB Duratec-16V SFI | 4 | 1,3 | TR5B-13 | 4559 | | LPG 4 | 1511 |
| Focus '04 | 1.6 | 80 | 07.04 - | G8DA DuraTorq-TDCi | 4 | █ | YE04 | 1684 | | D-POWER 40 | 1684 |
| Focus '04 | 1.6 | 80 | 07.04 - | G8DB DuraTorq-TDCi | 4 | █ | YE04 | 1684 | | D-POWER 40 | 1684 |
| Focus '04 | 1.6 | 85 | 07.04 - | HXDA Duratec-16V Ti-VCT | 4 | 1,3 | TR5B-13 | 4559 | | LPG 4 | 1511 |
| Focus '04 | 1.6 | 85 | 07.04 - | HXDB Duratec-16V Ti-VCT | 4 | 1,3 | TR5B-13 | 4559 | | LPG 4 | 1511 |
| Focus '04 | 1.8 | 92 | 07.04 - | Q7DA Duratec-HE SFI | 4 | 1,3 | ITR6F13 | 4477 | | LPG 5 | 1516 |
| Focus '04 | 1.8 | 92 | 06 - | QQDA Duratec-HE SFI | 4 | 1,3 | ITR6F13 | 4477 | | LPG 5 | 1516 |
| Focus '04 | 1.8 | 92 | 07.04 - | QQDB Duratec-HE SFI | 4 | 1,3 | ITR6F13 | 4477 | | LPG 5 | 1516 |
| Focus '04 | 1.8 | 96 | 06 - | QQDD Duratec-HE SFI | 4 | 1,3 | ITR6F13 | 4477 | | LPG 5 | 1516 |
| Focus '04 | 2.0 | 98 | 07.04 - | G6DC DuraTorq-TDCi | 4 | █ | Y1005J | 7957 | | D-POWER 56 | 7957 |
| Focus '04 | 2.0 | 98 | 07.04 - | G6DE DuraTorq-TDCi | 4 | █ | Y1005J | 7957 | | D-POWER 56 | 7957 |
| Focus '04 | 2.0 | 98 | 07.04 - | G6DF DuraTorq-TDCi | 4 | █ | Y1005J | 7957 | | D-POWER 56 | 7957 |
| Focus '04 | 2.0 | 100 | 07.04 - | G6DA DuraTorq-TDCi | 4 | █ | Y1005J | 7957 | | D-POWER 56 | 7957 |
| Focus '04 | 2.0 | 100 | 07.04 - | G6DB DuraTorq-TDCi | 4 | █ | Y1005J | 7957 | | D-POWER 56 | 7957 |
| Focus '04 | 2.0 | 100 | 07.04 - | G6DD DuraTorq-TDCi | 4 | █ | Y1005J | 7957 | | D-POWER 56 | 7957 |
| Focus '04 | 2.0 | 107 | 07.04 - | AODA Duratec-HE SFI | 4 | 1,3 | ITR6F13 | 4477 | | LPG 5 | 1516 |
| Focus '04 | 2.0 | 107 | 07.04 - | AODB Duratec-HE SFI | 4 | 1,3 | ITR6F13 | 4477 | | LPG 5 | 1516 |
| Focus '04 | 2.0 | 107 | 06 - | SYDA Duratec-HE SFI | 4 | 1,3 | ITR6F13 | 4477 | | LPG 5 | 1516 |
| Focus '04 CNG | 2.0 | 93 | 03.09 - | Duratec-HE SFI | 4 | 1,3 | ITR6F13 | 4477 | | LPG 5 | 1516 |
| Focus '04 LPG | 2.0 | 104 | 03.09 - | Duratec-HE SFI | 4 | 1,3 | ITR6F13 | 4477 | | LPG 5 | 1516 |
| Focus '98 | 1.4 | 55 | 08.98 - 12.04 | FXDA ZETEC-SE SFI | 4 | 1,3 | PTR5A-13 | 2467 | 25 | LPG 4 | 1511 |
| Focus '98 | 1.4 | 55 | 08.98 - 12.04 | FXDB ZETEC-SE SFI | 4 | 1,3 | PTR5A-13 | 2467 | 25 | LPG 4 | 1511 |
| Focus '98 | 1.4 | 55 | 08.98 - 12.04 | FXDC ZETEC-SE SEFI | 4 | 1,3 | PTR5A-13 | 2467 | 25 | LPG 4 | 1511 |
| Focus '98 | 1.4 | 55 | 08.98 - 12.04 | FXDD ZETEC-SE SFI | 4 | 1,3 | PTR5A-13 | 2467 | 25 | LPG 4 | 1511 |
| Focus '98 | 1.6 | 72 | 08.98 - 12.04 | CDDA Duratec SFI | 4 | 1,3 | TR5B-13 | 4559 | | LPG 4 | 1511 |
| Focus '98 | 1.6 | 74 | 08.98 - 12.04 | FYDA ZETEC-SE SFI | 4 | 1,3 | PTR5A-13 | 2467 | 25 | LPG 4 | 1511 |
| Focus '98 | 1.6 | 74 | 08.98 - 12.04 | FYDB ZETEC-SE SFI | 4 | 1,3 | PTR5A-13 | 2467 | 25 | LPG 4 | 1511 |
| Focus '98 | 1.6 | 74 | 08.98 - 12.04 | FYDC ZETEC-SE SFI | 4 | 1,3 | PTR5A-13 | 2467 | 25 | LPG 4 | 1511 |
| Focus '98 | 1.6 | 74 | 08.98 - 12.04 | FYDD ZETEC-SE SFI | 4 | 1,3 | PTR5A-13 | 2467 | 25 | LPG 4 | 1511 |
| Focus '98 | 1.6 | 74 | 08.98 - 12.04 | FYDH ZETEC-SE SFI | 4 | 1,3 | PTR5A-13 | 2467 | 25 | LPG 4 | 1511 |
| Focus '98 | 1.8 | 55 | 08.98 - 12.04 | BHDA Endura-DI | 4 | █ | Y-524J | 4520 | | D-POWER 27 | 4520 |
| Focus '98 | 1.8 | 55 | 08.98 - 12.04 | BHDB Endura-DI | 4 | █ | Y-524J | 4520 | | D-POWER 27 | 4520 |
| Focus '98 | 1.8 | 66 | 08.98 - 12.04 | C9DA Endura-DI | 4 | █ | Y-524J | 4520 | | D-POWER 27 | 4520 |
| Focus '98 | 1.8 | 66 | 08.98 - 12.04 | C9DB Endura-DI | 4 | █ | Y-524J | 4520 | | D-POWER 27 | 4520 |
| Focus '98 | 1.8 | 74 | 08.98 - 12.04 | FFDA DuraTorq-TDCi | 4 | █ | Y-524J | 4520 | | D-POWER 27 | 4520 |
| Focus '98 | 1.8 | 85 | 08.98 - 12.04 | EYDB ZETEC-E SFI | 4 | 1,3 | PTR5A-13 | 2467 | 25 | LPG 4 | 1511 |
| Focus '98 | 1.8 | 85 | 08.98 - 12.04 | EYDC ZETEC-E SFI | 4 | 1,3 | PTR5A-13 | 2467 | 25 | LPG 4 | 1511 |
| Focus '98 | 1.8 | 85 | 08.98 - 12.04 | EYDD ZETEC-E SFI | 4 | 1,3 | PTR5A-13 | 2467 | 25 | LPG 4 | 1511 |
| Focus '98 | 1.8 | 85 | 08.98 - 12.04 | EYDE ZETEC-E SFI | 4 | 1,3 | PTR5A-13 | 2467 | 25 | LPG 4 | 1511 |



ℓ kW

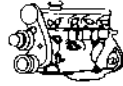

Cyl.

Order-
No.VLINE
No.LPG/CNG
D-PowerOrder-
No.**FORD**

| | | | | | | | | | | | |
|--------------------|------|-----|---------------|----------------------|---|-----|------------|------|----|------------|------|
| Focus '98 | 1.8 | 85 | 08.98 - 12.04 | EYDF ZETEC-E SFI | 4 | 1,3 | PTR5A-13 | 2467 | 25 | LPG 4 | 1511 |
| Focus '98 | 1.8 | 85 | 08.98 - 12.04 | EYDG ZETEC-E SFI | 4 | 1,0 | TR5A-10 | 0005 | | LPG 4 | 1511 |
| Focus '98 | 1.8 | 85 | 08.98 - 12.04 | EYDI ZETEC-E SFI | 4 | 1,0 | TR5A-10 | 0005 | | LPG 4 | 1511 |
| Focus '98 | 1.8 | 85 | 08.98 - 12.04 | EYDJ ZETEC-E SFI | 4 | 1,0 | TR5A-10 | 0005 | | LPG 4 | 1511 |
| Focus '98 | 1.8 | 85 | 08.98 - 12.04 | EYDL ZETEC-E SFI | 4 | 1,0 | TR5A-10 | 0005 | | LPG 4 | 1511 |
| Focus '98 | 1.8 | 85 | 08.98 - 12.04 | F9DB DuraTorq-TDCi | 4 | █ | Y-524J | 4520 | | D-POWER 27 | 4520 |
| Focus '98 | 2.0 | 96 | 08.98 - 12.04 | EDDB ZETEC-E SFI | 4 | 1,3 | PTR5A-13 | 2467 | 25 | LPG 4 | 1511 |
| Focus '98 | 2.0 | 96 | 08.98 - 12.04 | EDDC ZETEC-E SFI | 4 | 1,3 | PTR5A-13 | 2467 | 25 | LPG 4 | 1511 |
| Focus '98 | 2.0 | 96 | 08.98 - 12.04 | EDDD ZETEC-E SFI | 4 | 1,3 | PTR5A-13 | 2467 | 25 | LPG 4 | 1511 |
| Focus '98 | 2.0 | 96 | 08.98 - 12.04 | EDDF ZETEC-E SFI | 4 | 1,3 | PTR5A-13 | 2467 | 25 | LPG 4 | 1511 |
| Focus '98 (RUS) | 1.8 | 85 | 08.98 - 12.04 | EYDK ZETEC-E EFI | 4 | 1,3 | PTR5A-13 | 2467 | 25 | LPG 4 | 1511 |
| Focus '98 RS Turbo | 2.0 | 158 | 10.02 - 12.04 | HMDA Duratec RS SFI | 4 | 1,0 | PLTR6A-10G | 3587 | | PLTR6A-10G | 3587 |
| Focus '98 TDCi | 1.8 | 85 | 08.98 - 12.04 | F9DA DuraTorq-TDCi | 4 | █ | Y-524J | 4520 | | D-POWER 27 | 4520 |
| Focus '98 Turbo Di | 1.8 | 66 | 08.98 - 12.04 | C9DC Endura-DI | 4 | █ | Y-524J | 4520 | | D-POWER 27 | 4520 |
| Focus CC TDCi | 2.0 | 100 | 05.06 - | DD0X | 4 | █ | Y1005J | 7957 | | D-POWER 56 | 7957 |
| Focus C-Max TDCi | 2.0 | 100 | 10.03 - 08.07 | G6DA | 4 | █ | Y1005J | 7957 | | D-POWER 56 | 7957 |
| Focus C-Max TDCi | 2.0 | 100 | 10.03 - 08.07 | G6DB | 4 | █ | Y1005J | 7957 | | D-POWER 56 | 7957 |
| Focus C-Max TDCi | 2.0 | 100 | 10.03 - 08.07 | G6DD | 4 | █ | Y1005J | 7957 | | D-POWER 56 | 7957 |
| Fusion | 1.25 | 55 | 06.02 - | FUJA Duratec 16V SFI | 4 | 1,3 | PTR5A-13 | 2467 | 25 | LPG 4 | 1511 |
| Fusion | 1.25 | 55 | 06.02 - | FUJB Duratec 16V SFI | 4 | 1,3 | PTR5A-13 | 2467 | 25 | LPG 4 | 1511 |
| Fusion | 1.4 | 59 | 06.02 - | FXJA Duratec 16V SFI | 4 | 1,3 | PTR5A-13 | 2467 | 25 | LPG 4 | 1511 |
| Fusion | 1.4 | 59 | 06.02 - | FXJB Duratec 16V SFI | 4 | 1,3 | PTR5A-13 | 2467 | 25 | LPG 4 | 1511 |
| Fusion | 1.6 | 74 | 06.02 - | FYJA Duratec 16V SFI | 4 | 1,3 | PTR5A-13 | 2467 | 25 | LPG 4 | 1511 |
| Fusion | 1.6 | 74 | 06.02 - | FYJB Duratec 16V SFI | 4 | 1,3 | PTR5A-13 | 2467 | 25 | LPG 4 | 1511 |
| Fusion TDCi | 1.4 | 50 | 01.05 - | F6JA DuraTorq-TDCi | 4 | █ | YE05 | 5207 | | | |
| Fusion TDCi | 1.4 | 50 | 06.02 - 12.04 | F6JA DuraTorq-TDCi | 4 | █ | YE04 | 1684 | | D-POWER 40 | 1684 |
| Fusion TDCi | 1.4 | 50 | 01.05 - | F6JB DuraTorq-TDCi | 4 | █ | YE05 | 5207 | | | |
| Fusion TDCi | 1.4 | 50 | 06.02 - 12.04 | F6JB DuraTorq-TDCi | 4 | █ | YE04 | 1684 | | D-POWER 40 | 1684 |
| Fusion TDCi | 1.6 | 66 | 06.02 - | HHJA DuraTorq-TDCi | 4 | █ | YE04 | 1684 | | D-POWER 40 | 1684 |
| Fusion TDCi | 1.6 | 66 | 06.02 - | HHJB DuraTorq-TDCi | 4 | █ | YE04 | 1684 | | D-POWER 40 | 1684 |
| Galaxy | 2.0 | 85 | 02.95 - 03.00 | NSE DOHC SEFI | 4 | 1,1 | BKR7EVX-11 | 4685 | | BKR8EIX | 2668 |
| Galaxy /2 | 2.0 | 85 | 04.00 - 02.06 | ZVSA DOHC SEFI | 4 | 1,1 | BKR7EVX-11 | 4685 | | BKR8EIX | 2668 |
| Galaxy /2 16V | 2.3 | 103 | 04.00 - 02.06 | E5SB DOHC 16V SEFI | 4 | 1,1 | BKR6EVX-11 | 3540 | | LPG 1 | 1496 |
| Galaxy /2 16V | 2.3 | 107 | 04.00 - 02.06 | E5SA DOHC 16V SEFI | 4 | 1,1 | BKR6EVX-11 | 3540 | | LPG 1 | 1496 |
| Galaxy /2 24V | 2.8 | 150 | 04.00 - 02.06 | AYL CD V6 24V SEFI | 6 | 1,1 | PZFR5D-11 | 7968 | 34 | LPG 6 | 1565 |
| Galaxy /2 TDI | 1.9 | 66 | 04.00 - 02.06 | ANU | 4 | █ | Y-732J | 5605 | | D-POWER 4 | 5605 |
| Galaxy /2 TDI | 1.9 | 85 | 04.00 - 02.06 | AUY | 4 | █ | Y-732J | 5605 | | D-POWER 4 | 5605 |
| Galaxy /2 TDI | 1.9 | 96 | 04.00 - 02.06 | ASZ | 4 | █ | Y-732J | 5605 | | D-POWER 4 | 5605 |
| Galaxy /2 TDI | 1.9 | 110 | 04.00 - 02.06 | BTB | 4 | █ | Y-732J | 5605 | | D-POWER 4 | 5605 |
| Galaxy 16V | 2.3 | 107 | 02.95 - 03.00 | Y5B DOHC 16V SEFI | 4 | 1,1 | BKR6EVX-11 | 3540 | | LPG 1 | 1496 |
| Galaxy TDI | 1.9 | 66 | 02.95 - 02.96 | 1Z | 4 | █ | Y-732J | 5605 | | D-POWER 4 | 5605 |
| Galaxy TDI | 1.9 | 66 | 03.96 - 03.00 | 1Z | 4 | █ | Y-732J | 5605 | | D-POWER 4 | 5605 |
| Galaxy TDI | 1.9 | 66 | 09.96 - 03.00 | AHU | 4 | █ | Y-732J | 5605 | | D-POWER 4 | 5605 |
| Galaxy TDI | 1.9 | 66 | 02.95 - 03.00 | ANU | 4 | █ | Y-732J | 5605 | | D-POWER 4 | 5605 |
| Galaxy TDI | 1.9 | 81 | 02.95 - 08.99 | AFN | 4 | █ | Y-732J | 5605 | | D-POWER 4 | 5605 |
| Galaxy TDI | 1.9 | 81 | 09.99 - 03.00 | AVG | 4 | █ | Y-732J | 5605 | | D-POWER 4 | 5605 |
| Galaxy TDI | 1.9 | | 06.95 - | AJM | 4 | █ | Y-732J | 5605 | | D-POWER 4 | 5605 |
| Galaxy VR6 4x4 | 2.8 | 128 | 02.95 - 03.98 | AAA CD V6 SEFI | 6 | | BKR5EKUP | 2890 | | | |
| Galaxy VR6 4x4 | 2.8 | 128 | 04.98 - 03.00 | AMY CD V6 SEFI | 6 | | BKR5EKUP | 2890 | | | |
| Granada '82 | 1.6 | 55 | 08.81 - 04.85 | LCK OHC VV | 4 | 0,8 | AP6FS | 2710 | | | |
| Granada '82 | 2.0 | 64 | 08.81 - 04.85 | NYU V6 2V | 4 | 0,8 | BPR6ES | 7822 | 2 | LPG 2 | 1497 |
| Granada '82 | 2.0 | 66 | 08.81 - 04.85 | NYP V6 2V | 4 | 0,8 | BPR6ES | 7822 | 2 | LPG 2 | 1497 |



ℓ kW

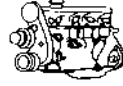

Cyl.

Order-
No. No.LPG/CNG
D-PowerOrder-
No.**FORD**

| | | | | | | | | | | | | |
|-------------|-----|-----|---------------|--------------------|---|-----|------------|------|----|-------|-----------|------|
| Granada '82 | 2.0 | 72 | 08.81 - 04.85 | NE2 OHC 2V | 4 | 0,8 | APR6FS | 2922 | | | | |
| Granada '82 | 2.0 | 74 | 08.81 - 04.85 | NEP OHC 2V | 4 | 0,8 | AP6FS | 2710 | | | | |
| Granada '82 | 2.0 | 77 | 08.81 - 04.85 | NEK OHC 2V | 4 | 0,8 | AP6FS | 2710 | | | | |
| Granada '82 | 2.3 | 82 | 08.81 - 04.85 | YYU V6 2V | 6 | 0,8 | BPR6ES | 7822 | 2 | LPG 2 | | 1497 |
| Granada '82 | 2.3 | 84 | 08.81 - 04.85 | YYP V6 2V | 6 | 0,8 | BPR6ES | 7822 | 2 | LPG 2 | | 1497 |
| Granada '82 | 2.5 | | 08.81 - 04.85 | STP D | 4 | █ | Y-924J | 7906 | | | D-POWER 1 | 7906 |
| Granada '82 | 2.8 | 97 | 08.81 - 04.85 | PYU V6 2V | 6 | 0,8 | BPR6ES | 7822 | 2 | LPG 2 | | 1497 |
| Granada '82 | 2.8 | 99 | 08.81 - 04.85 | PYA V6 2V | 6 | 0,8 | BPR6ES | 7822 | 2 | LPG 2 | | 1497 |
| Granada '82 | 2.8 | 108 | 08.81 - 04.85 | PRD V6 FI | 6 | 0,8 | BPR6ES | 7822 | 2 | LPG 2 | | 1497 |
| Granada '82 | 2.8 | 109 | 08.81 - 04.85 | PR2 V6 FI | 6 | 0,8 | BPR6ES | 7822 | 2 | LPG 2 | | 1497 |
| Granada '82 | 2.8 | 110 | 08.81 - 04.85 | PRC V6 FI | 6 | 0,8 | BPR6ES | 7822 | 2 | LPG 2 | | 1497 |
| Granada '85 | 1.8 | 66 | 05.85 - 10.94 | REC OHC 2V | 4 | 0,8 | APR6FS | 2922 | | | | |
| Granada '85 | 2.0 | 74 | 05.85 - 10.94 | NE4 OHC 2V | 4 | 0,8 | APR6FS | 2922 | | | | |
| Granada '85 | 2.0 | 74 | 05.85 - 10.94 | NER OHC 2V | 4 | 0,8 | APR6FS | 2922 | | | | |
| Granada '85 | 2.0 | 74 | 05.85 - 10.94 | NRC OHC EFI | 4 | 0,8 | APR6FS | 2922 | | | | |
| Granada '85 | 2.0 | 77 | 05.85 - 10.94 | N8D DOHC 2V | 4 | 0,8 | BCPR6ES | 2330 | 12 | LPG 3 | | 1498 |
| Granada '85 | 2.0 | 77 | 05.85 - 10.94 | NEL OHC 2V | 4 | 0,8 | APR6FS | 2922 | | | | |
| Granada '85 | 2.0 | 77 | 05.85 - 10.94 | NEL OHC 2V Cat. | 4 | 0,8 | APR6FS | 2922 | | | | |
| Granada '85 | 2.0 | 80 | 05.85 - 10.94 | N8B DOHC 2V | 4 | 0,8 | BCPR6ES | 2330 | 12 | LPG 3 | | 1498 |
| Granada '85 | 2.0 | 85 | 05.85 - 10.94 | N9F DOHC EFI | 4 | 0,8 | BCPR6ES | 2330 | 12 | LPG 3 | | 1498 |
| Granada '85 | 2.0 | 85 | 05.85 - 10.94 | NRA OHC EFI | 4 | 0,8 | APR6FS | 2922 | | | | |
| Granada '85 | 2.0 | 85 | 05.85 - 10.94 | NRA OHC EFI Cat. | 4 | 0,8 | APR6FS | 2922 | | | | |
| Granada '85 | 2.0 | 85 | 05.85 - 10.94 | NRI OHC EFI | 4 | 0,8 | APR6FS | 2922 | | | | |
| Granada '85 | 2.0 | 88 | 05.85 - 10.94 | N9D DOHC EFI | 4 | 0,8 | BCPR6ES | 2330 | 12 | LPG 3 | | 1498 |
| Granada '85 | 2.0 | 90 | 05.85 - 10.94 | N9B DOHC EFI | 4 | 0,8 | BCPR6ES | 2330 | 12 | LPG 3 | | 1498 |
| Granada '85 | 2.4 | 92 | 05.85 - 10.94 | ARD V6 EFI | 6 | 1,0 | BPR6EFS | 3623 | 7 | LPG 5 | | 1516 |
| Granada '85 | 2.4 | 96 | 05.85 - 10.94 | ARC V6 EFI | 6 | 0,8 | BCPR6ES | 2330 | 12 | LPG 3 | | 1498 |
| Granada '85 | 2.5 | 51 | 05.85 - 10.94 | STR D | 4 | █ | Y-924J | 7906 | | | D-POWER 1 | 7906 |
| Granada '85 | 2.5 | 68 | 05.85 - 10.94 | SFA D TURBO | 4 | █ | Y-924J | 7906 | | | D-POWER 1 | 7906 |
| Granada '85 | 2.5 | 68 | 05.85 - 10.94 | SFB D TURBO | 4 | █ | Y-924J | 7906 | | | D-POWER 1 | 7906 |
| Granada '85 | 2.8 | 105 | 05.85 - 10.94 | PR4 V6 EFI | 6 | 0,8 | BPR6ES | 7822 | 2 | LPG 2 | | 1497 |
| Granada '85 | 2.8 | 107 | 05.85 - 10.94 | PR3 V6 EFI | 6 | 0,8 | BPR6ES | 7822 | 2 | LPG 2 | | 1497 |
| Granada '85 | 2.8 | 110 | 05.85 - 10.94 | PRE V6 EFI | 6 | 0,8 | BPR6ES | 7822 | 2 | LPG 2 | | 1497 |
| Granada '85 | 2.9 | 107 | 05.85 - 10.94 | BRD V6 EFI | 6 | 1,0 | BPR6EFS | 3623 | 7 | LPG 5 | | 1516 |
| Granada '85 | 2.9 | 107 | 05.85 - 10.94 | BRE V6 EFI | 6 | 1,0 | BPR6EFS | 3623 | 7 | LPG 5 | | 1516 |
| Granada '85 | 2.9 | 107 | 05.85 - 10.94 | BRF V6 EFI | 6 | 1,0 | BPR6EFS | 3623 | 7 | LPG 5 | | 1516 |
| Granada '85 | 2.9 | 110 | 05.85 - 10.94 | BRC V6 EFI | 6 | 0,8 | BCPR6ES | 2330 | 12 | LPG 3 | | 1498 |
| Granada '85 | 2.9 | 143 | 05.85 - 10.94 | BOA V6 24V EFI | 6 | 1,1 | BKR6EVX-11 | 3540 | | | LPG 1 | 1496 |
| Ka '08 | 1.2 | 51 | 08 - | | 4 | 1,0 | ZKR7A-10 | 1691 | | | LPG 8 | 6806 |
| Ka '96 | 1.3 | 36 | 09.96 - | JJD Endura-E SEFI | 4 | 1,0 | PTR5D-10 | 3784 | 31 | LPG 5 | | 1516 |
| Ka '96 | 1.3 | 36 | 09.96 - | JJF Endura-E SEFI | 4 | 1,0 | PTR5D-10 | 3784 | 31 | LPG 5 | | 1516 |
| Ka '96 | 1.3 | 36 | 09.96 - | JJG Endura-E SEFI | 4 | 1,0 | PTR5D-10 | 3784 | 31 | LPG 5 | | 1516 |
| Ka '96 | 1.3 | 36 | 09.96 - | JJH Endura-E SEFI | 4 | 1,0 | PTR5D-10 | 3784 | 31 | LPG 5 | | 1516 |
| Ka '96 | 1.3 | 36 | 09.96 - | JJL Endura-E SEFI | 4 | 1,0 | PTR5D-10 | 3784 | 31 | LPG 5 | | 1516 |
| Ka '96 | 1.3 | 37 | 09.96 - | JJB Endura-E SEFI | 4 | 1,0 | PTR5D-10 | 3784 | 31 | LPG 5 | | 1516 |
| Ka '96 | 1.3 | 44 | 09.96 - | BAA Duratec 8V SFI | 4 | 1,3 | TR5B-13 | 4559 | | | LPG 4 | 1511 |
| Ka '96 | 1.3 | 44 | 09.96 - | J4D Endura-E SEFI | 4 | 1,0 | PTR5D-10 | 3784 | 31 | LPG 5 | | 1516 |
| Ka '96 | 1.3 | 44 | 09.96 - | J4K Endura-E SEFI | 4 | 1,0 | PTR5D-10 | 3784 | 31 | LPG 5 | | 1516 |
| Ka '96 | 1.3 | 44 | 09.96 - | J4M Endura-E SEFI | 4 | 1,0 | PTR5D-10 | 3784 | 31 | LPG 5 | | 1516 |
| Ka '96 | 1.3 | 44 | 09.96 - | J4N Endura-E SEFI | 4 | 1,0 | PTR5D-10 | 3784 | 31 | LPG 5 | | 1516 |
| Ka '96 | 1.3 | 44 | 09.96 - | J4P Endura-E SEFI | 4 | 1,0 | PTR5D-10 | 3784 | 31 | LPG 5 | | 1516 |
| Ka '96 | 1.3 | 44 | 09.96 - | J4S Endura-E SEFI | 4 | 1,0 | PTR5D-10 | 3784 | 31 | LPG 5 | | 1516 |



ℓ kW

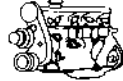

Cyl.

Order-
No.V-LINE
No.LPG/CNG
D-PowerOrder-
No.**FORD**

| | | | | | | | | | | | |
|-----------------------------|-----|-----|---------------|---------------------------|---|-----|------------|------|----|------------|------|
| Ka '96 | 1.3 | 51 | 09.96 - | A9A Duratec 8V SFI | 4 | 1,3 | TR5B-13 | 4559 | | LPG 4 | 1511 |
| Ka '96 | 1.3 | 51 | 09.96 - | A9B Duratec 8V SFI | 4 | 1,3 | TR5B-13 | 4559 | | LPG 4 | 1511 |
| Ka '96 | 1.6 | 70 | 09.96 - | CDB Duratec 8V SFI | 4 | 1,3 | PTR5A-13 | 2467 | 25 | LPG 4 | 1511 |
| Ka '96 | 1.6 | 70 | 09.96 - | CDC Duratec 8V SFI | 4 | 1,3 | PTR5A-13 | 2467 | 25 | LPG 4 | 1511 |
| Maverick '01 | 3.0 | 145 | 12.00 - 11.03 | AJ Duratec-VE SFI | 6 | 1,0 | TR5IX | 7397 | | LPG 5 | 1516 |
| Maverick '01 | 3.0 | 149 | 12.03 - | AJ Duratec-VE SFI | 6 | 1,0 | TR5IX | 7397 | | LPG 5 | 1516 |
| Maverick '01 16V | 2.0 | 91 | 12.00 - 11.03 | YF ZETEC-E SFI | 4 | 1,3 | PTR5A-13 | 2467 | 25 | LPG 4 | 1511 |
| Maverick '01 16V | 2.3 | 110 | 12.03 - | GZ Duratec-HE SFI | 4 | 1,3 | ITR6F13 | 4477 | | LPG 5 | 1516 |
| Maverick '93 | 2.4 | 85 | 06.93 - 04.98 | KA24 OHC 12V SEFI | 4 | 1,1 | ZFR5E-11 | 4435 | | | |
| Maverick '93 | 2.4 | 87 | 06.93 - 04.98 | KA24 OHC 12V SEFI | 4 | 1,1 | ZFR5E-11 | 4435 | | | |
| Maverick '93 | 2.4 | 91 | 06.93 - 04.98 | KA24 OHC 12V SEFI | 4 | 1,1 | ZFR5E-11 | 4435 | | | |
| Maverick '93 | 2.7 | 74 | 04.93 - 04.98 | TD27 | 4 | █ | Y-712RS | 6140 | | | |
| Maverick '93 | 2.7 | 92 | 05.96 - 04.98 | TD27E | 4 | █ | CY58 | 5486 | | | |
| Mondeo '01 | 3.0 | 150 | 10.00 - 8.07 | REBA Duratec-ST SFI | 6 | 1,3 | PTR6D-13G | 6989 | | LPG 5 | 1516 |
| Mondeo '01 ST 220 | 3.0 | 166 | 10.00 - 8.07 | MEBA Duratec-ST SFI | 6 | 1,3 | PTR6D-13G | 6989 | | LPG 5 | 1516 |
| Mondeo '01 | 1.8 | 81 | 10.00 - 8.07 | CGBA Duratec-HE SFI | 4 | 1,3 | PTR6F-13 | 7569 | | LPG 5 | 1516 |
| Mondeo '01 | 1.8 | 81 | 10.00 - 8.07 | CGBB Duratec-HE SFI | 4 | 1,3 | PTR6F-13 | 7569 | | LPG 5 | 1516 |
| Mondeo '01 | 1.8 | 92 | 10.00 - 8.07 | CHBA Duratec-HE SFI | 4 | 1,3 | PTR6F-13 | 7569 | | LPG 5 | 1516 |
| Mondeo '01 | 1.8 | 92 | 10.00 - 8.07 | CHBB Duratec-HE SFI | 4 | 1,3 | PTR6F-13 | 7569 | | LPG 5 | 1516 |
| Mondeo '01 | 2.0 | 107 | 10.00 - 8.07 | CJBA Duratec-HE SFI | 4 | 1,3 | PTR6F-13 | 7569 | | LPG 5 | 1516 |
| Mondeo '01 | 2.0 | 107 | 10.00 - 8.07 | CJBB Duratec-HE SFI | 4 | 1,3 | PTR6F-13 | 7569 | | LPG 5 | 1516 |
| Mondeo '01 | 2.5 | 125 | 10.00 - 8.07 | LCBD Duratec-VE SFI | 6 | 1,3 | PTR5D-13 | 6644 | | LPG 5 | 1516 |
| Mondeo '01 TDCi | 2.0 | 66 | 10.00 - 8.07 | D5BA DuraTorq-DI | 4 | █ | Y-525J | 4090 | | D-POWER 35 | 4090 |
| Mondeo '01 TDCi | 2.0 | 85 | 10.00 - 8.07 | D6BA DuraTorq-DI | 4 | █ | Y-525J | 4090 | | D-POWER 35 | 4090 |
| Mondeo '01 TDCi | 2.0 | 85 | 10.00 - 8.07 | HJBA DuraTorq-TDCi | 4 | █ | Y-525J | 4090 | | D-POWER 35 | 4090 |
| Mondeo '01 TDCi | 2.0 | 85 | 10.00 - 8.07 | HJBB DuraTorq-TDCi | 4 | █ | Y-525J | 4090 | | D-POWER 35 | 4090 |
| Mondeo '01 TDCi | 2.0 | 85 | 10.00 - 8.07 | HJBC DuraTorq-TDCi | 4 | █ | Y-525J | 4090 | | D-POWER 35 | 4090 |
| Mondeo '01 TDCi | 2.0 | 85 | 10.00 - 8.07 | SDBA DuraTorq-TDCi | 4 | █ | Y-525J | 4090 | | D-POWER 35 | 4090 |
| Mondeo '01 TDCi | 2.0 | 96 | 10.00 - 8.07 | FMBA DuraTorq-TDCi | 4 | █ | Y-525J | 4090 | | D-POWER 35 | 4090 |
| Mondeo '01 TDCi | 2.0 | 96 | 10.00 - 8.07 | N7BA DuraTorq-TDCi | 4 | █ | Y-525J | 4090 | | D-POWER 35 | 4090 |
| Mondeo '01 TDCi | 2.2 | 110 | 09.04 - 8.07 | QJBC DuraTorq-TDCi | 4 | █ | Y-525J | 4090 | | D-POWER 35 | 4090 |
| Mondeo '01 TDCi | 2.2 | 110 | 09.04 - 8.07 | QJBD DuraTorq-TDCi | 4 | █ | Y-525J | 4090 | | D-POWER 35 | 4090 |
| Mondeo '01 TDCi | 2.2 | 114 | 09.04 - 8.07 | QJBA DuraTorq-TDCi | 4 | █ | Y-525J | 4090 | | D-POWER 35 | 4090 |
| Mondeo '01 TDCi | 2.2 | 114 | 09.04 - 8.07 | QJBB DuraTorq-TDCi | 4 | █ | Y-525J | 4090 | | D-POWER 35 | 4090 |
| Mondeo '07 LPG | 2.0 | 104 | 03.09 - | Duratec-HE | 4 | 1,3 | ITR6F13 | 4477 | | LPG 5 | 1516 |
| Mondeo '07 Ti-VCT | 1.6 | 81 | 02.07 - | RHBA Duratec - 16V Ti-VCT | 4 | 1,3 | TR5B-13 | 4559 | | LPG 4 | 1511 |
| Mondeo '07 Ti-VCT | 2.3 | 118 | 02.07 - | SEBA Duratec | 5 | 1,3 | ILTR5A-13G | 3811 | | ILTR6A-13G | 3789 |
| Mondeo '07 Ti-VCT | 2.5 | 162 | 02.07 - | HUBA Duratec-ST (V15) SFI | 5 | | PLFR6A | 5472 | | LPG 7 | 1640 |
| Mondeo '07 Ti-VCT Flexifuel | 2.0 | 107 | 02.07 - | AOBA Duratec - HE | 4 | 1,3 | ITR6F13 | 4477 | | LPG 5 | 1516 |
| Mondeo '93 | 1.6 | 65 | 01.93 - 07.96 | L1J ZETEC-E SEFI | 4 | 1,3 | PTR5A-13 | 2467 | 25 | LPG 4 | 1511 |
| Mondeo '93 | 1.6 | 66 | 01.93 - 07.96 | L1F ZETEC SEFI | 4 | 1,3 | PTR5A-13 | 2467 | 25 | LPG 4 | 1511 |
| Mondeo '93 | 1.8 | 65 | 01.93 - 07.96 | RFM D TCI | 4 | █ | Y-910R | 4751 | | D-POWER 3 | 3617 |
| Mondeo '93 | 1.8 | 65 | 01.93 - 07.96 | RFN D TCI | 4 | █ | Y-910R | 4751 | | D-POWER 3 | 3617 |
| Mondeo '93 | 1.8 | 82 | 01.93 - 07.96 | RKB ZETEC-E SEFI | 4 | 1,3 | PTR5A-13 | 2467 | 25 | LPG 4 | 1511 |
| Mondeo '93 | 1.8 | 85 | 01.93 - 07.96 | RKA ZETEC SEFI | 4 | 1,3 | PTR5A-13 | 2467 | 25 | LPG 4 | 1511 |
| Mondeo '93 | 2.0 | 100 | 01.93 - 07.96 | NGA ZETEC SEFI | 4 | 1,3 | PTR5A-13 | 2467 | 25 | LPG 4 | 1511 |
| Mondeo '93 | 2.5 | 125 | 01.93 - 07.96 | SEA Duratec-VE SEFI | 6 | 1,0 | PTR5D-10 | 3784 | 31 | LPG 5 | 1516 |
| Mondeo '97 | 1.6 | 65 | 08.96 - 09.00 | L1J ZETEC-E SEFI | 4 | 1,3 | PTR5A-13 | 2467 | 25 | LPG 4 | 1511 |
| Mondeo '97 | 1.6 | 70 | 08.96 - 09.00 | L1L ZETEC-E SEFI | 4 | 1,3 | PTR5A-13 | 2467 | 25 | LPG 4 | 1511 |
| Mondeo '97 | 1.6 | 70 | 08.96 - 09.00 | L1N ZETEC-E SEFI | 4 | 1,3 | PTR5A-13 | 2467 | 25 | LPG 4 | 1511 |
| Mondeo '97 | 1.6 | 70 | 08.96 - 09.00 | L1Q ZETEC-E SEFI | 4 | 1,3 | PTR5A-13 | 2467 | 25 | LPG 4 | 1511 |
| Mondeo '97 | 1.8 | 66 | 08.96 - 09.00 | RFN Endura-De TCI | 4 | █ | Y-937J | 5148 | | D-POWER 5 | 7503 |



ℓ kW

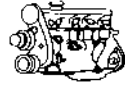

Cyl.

Order-
No. No.LPG/CNG
D-PowerOrder-
No.**FORD**

| | | | | | | | | | | | |
|-------------------|-----|-----|---------------|---------------------|---|-----|------------|------|----|-----------|------|
| Mondeo '97 | 1.8 | 85 | 08.96 - 09.00 | RKB ZETEC-E SEFI | 4 | 1,3 | PTR5A-13 | 2467 | 25 | LPG 4 | 1511 |
| Mondeo '97 | 1.8 | 85 | 08.96 - 09.00 | RKF ZETEC-E SEFI | 4 | 1,3 | PTR5A-13 | 2467 | 25 | LPG 4 | 1511 |
| Mondeo '97 | 1.8 | 85 | 08.96 - 09.00 | RKH ZETEC-E SEFI | 4 | 1,3 | PTR5A-13 | 2467 | 25 | LPG 4 | 1511 |
| Mondeo '97 | 1.8 | 85 | 08.96 - 09.00 | RKJ ZETEC-E SEFI | 4 | 1,3 | PTR5A-13 | 2467 | 25 | LPG 4 | 1511 |
| Mondeo '97 | 1.8 | 85 | 08.96 - 09.00 | RKK ZETEC-E SEFI | 4 | 1,3 | PTR5A-13 | 2467 | 25 | LPG 4 | 1511 |
| Mondeo '97 | 2.0 | 96 | 08.96 - 09.00 | NGA ZETEC-E SEFI | 4 | 1,3 | PTR5A-13 | 2467 | 25 | LPG 4 | 1511 |
| Mondeo '97 | 2.0 | 96 | 08.96 - 09.00 | NGB ZETEC-E SEFI | 4 | 1,3 | PTR5A-13 | 2467 | 25 | LPG 4 | 1511 |
| Mondeo '97 | 2.0 | 96 | 08.96 - 09.00 | NGC ZETEC-E SEFI | 4 | 1,3 | PTR5A-13 | 2467 | 25 | LPG 4 | 1511 |
| Mondeo '97 | 2.0 | 96 | 08.96 - 09.00 | NGD ZETEC-E SEFI | 4 | 1,3 | PTR5A-13 | 2467 | 25 | LPG 4 | 1511 |
| Mondeo '97 | 2.5 | 125 | 08.96 - 09.00 | SEA Duratec-VE SEFI | 6 | 1,0 | PTR5D-10 | 3784 | 31 | LPG 5 | 1516 |
| Mondeo '97 | 2.5 | 125 | 08.96 - 09.00 | SEB Duratec-VE SEFI | 6 | 1,0 | PTR5D-10 | 3784 | 31 | LPG 5 | 1516 |
| Mondeo '97 | 2.5 | 125 | 08.96 - 09.00 | SEC Duratec-VE SEFI | 6 | 1,0 | PTR5D-10 | 3784 | 31 | LPG 5 | 1516 |
| Mondeo '97 ST 200 | 2.5 | 151 | 08.96 - 09.00 | SGA Duratec-VE SEFI | 6 | 1,3 | PTR6D-13G | 6989 | | LPG 5 | 1516 |
| Orion '83 | 1.3 | 51 | 05.83 - 12.85 | JPA CVH VV | 4 | 0,8 | BCPR6ES | 2330 | 12 | LPG 3 | 1498 |
| Orion '83 | 1.6 | 58 | 05.83 - 12.85 | LPA CVH VV | 4 | 0,8 | BCPR7ES | 3330 | | BCPR7EIX | 5690 |
| Orion '83 | 1.6 | 58 | 05.83 - 12.85 | LPI CVH VV | 4 | 0,8 | BCPR7ES | 3330 | | BCPR7EIX | 5690 |
| Orion '83 | 1.6 | 66 | 05.83 - 12.85 | L4B CVH FI | 4 | 0,8 | BCPR6ES | 2330 | 12 | LPG 3 | 1498 |
| Orion '83 | 1.6 | 77 | 05.83 - 12.85 | LRA CVH FI | 4 | 0,8 | BCPR7ES | 3330 | | BCPR7EIX | 5690 |
| Orion '83 | 1.6 | 77 | 05.83 - 12.85 | LRI CVH FI | 4 | 0,8 | BCPR7ES | 3330 | | BCPR7EIX | 5690 |
| Orion '86 | 1.3 | 44 | 01.86 - 07.90 | JBB HCS 2V | 4 | 1,0 | BPR6EFS | 3623 | 7 | LPG 5 | 1516 |
| Orion '86 | 1.3 | 44 | 01.86 - 07.90 | JLA VAL VV | 4 | 1,0 | BPR6EFS | 3623 | 7 | LPG 5 | 1516 |
| Orion '86 | 1.3 | 44 | 01.86 - 07.90 | JLA VAL VV Cat. | 4 | 1,0 | BPR6EFS | 3623 | 7 | LPG 5 | 1516 |
| Orion '86 | 1.3 | 44 | 01.86 - 07.90 | JLB VAL VV | 4 | 1,0 | BPR6EFS | 3623 | 7 | LPG 5 | 1516 |
| Orion '86 | 1.4 | 54 | 01.86 - 07.90 | F6B CVH CFI | 4 | 1,1 | BCPR6ES-11 | 7121 | 11 | LPG 3 | 1498 |
| Orion '86 | 1.4 | 54 | 01.86 - 07.90 | F6D CVH CFI | 4 | 1,1 | BCPR6ES-11 | 7121 | 11 | LPG 3 | 1498 |
| Orion '86 | 1.4 | 54 | 01.86 - 07.90 | FUC CVH 2V | 4 | 1,1 | BCPR7ES-11 | 1095 | | BCPR7EIX | 5690 |
| Orion '86 | 1.4 | 55 | 01.86 - 07.90 | FUA CVH 2V | 4 | 0,8 | BCPR6ES | 2330 | 12 | LPG 3 | 1498 |
| Orion '86 | 1.4 | 55 | 01.86 - 07.90 | FUA CVH 2V Cat. | 4 | 0,8 | BCPR6ES | 2330 | 12 | LPG 3 | 1498 |
| Orion '86 | 1.6 | 40 | 01.86 - 07.90 | LTC | 4 | █ | Y-907R | 4479 | | | |
| Orion '86 | 1.6 | 65 | 01.86 - 07.90 | LUG CVH 2V | 4 | 0,8 | BCPR6ES | 2330 | 12 | LPG 3 | 1498 |
| Orion '86 | 1.6 | 66 | 01.86 - 07.90 | L4B CVH FI | 4 | 0,8 | BCPR6ES | 2330 | 12 | LPG 3 | 1498 |
| Orion '86 | 1.6 | 66 | 01.86 - 07.90 | LUC CVH 2V | 4 | 0,8 | BCPR6ES | 2330 | 12 | LPG 3 | 1498 |
| Orion '86 | 1.6 | 66 | 01.86 - 07.90 | LUC CVH 2V Cat. | 4 | 0,8 | BCPR6ES | 2330 | 12 | LPG 3 | 1498 |
| Orion '86 | 1.6 | 75 | 01.86 - 07.90 | LJB CVH EFI | 4 | 1,1 | BCPR6ES-11 | 7121 | 11 | LPG 3 | 1498 |
| Orion '86 | 1.6 | 77 | 01.86 - 07.90 | LRB CVH FI | 4 | 0,8 | BCPR7ES | 3330 | | BCPR7EIX | 5690 |
| Orion '86 | 1.6 | 77 | 01.86 - 07.90 | LRB CVH FI Cat. | 4 | 0,8 | BCPR7ES | 3330 | | BCPR7EIX | 5690 |
| Orion '86 | 1.6 | 79 | 01.86 - 07.90 | LJA CVH EFI | 4 | 1,1 | BCPR6ES-11 | 7121 | 11 | LPG 3 | 1498 |
| Orion '86 | 1.8 | 44 | 01.86 - 07.90 | RTA | 4 | █ | Y-910R | 4751 | | D-POWER 3 | 3617 |
| Orion '86 | 1.8 | 44 | 01.86 - 07.90 | RTB | 4 | █ | Y-910R | 4751 | | D-POWER 3 | 3617 |
| Orion '91 | 1.3 | 44 | 08.90 - 07.93 | J6A HCS CFI | 4 | 1,0 | PTR5D-10 | 3784 | 31 | LPG 5 | 1516 |
| Orion '91 | 1.3 | 44 | 08.90 - 07.93 | JBE HCS 2V | 4 | 1,0 | PTR5D-10 | 3784 | 31 | LPG 5 | 1516 |
| Orion '91 | 1.3 | 46 | 08.90 - 07.93 | JBD HCS 2V | 4 | 1,0 | PTR5D-10 | 3784 | 31 | LPG 5 | 1516 |
| Orion '91 | 1.4 | 52 | 08.90 - 07.93 | F6F CVH CFI | 4 | 1,1 | BCPR6ES-11 | 7121 | 11 | LPG 3 | 1498 |
| Orion '91 | 1.4 | 52 | 08.90 - 07.93 | F6G CVH CFI | 4 | 1,1 | BCPR6ES-11 | 7121 | 11 | LPG 3 | 1498 |
| Orion '91 | 1.4 | 54 | 08.90 - 07.93 | FUH CVH 2V | 4 | 0,8 | BCPR6ES | 2330 | 12 | LPG 3 | 1498 |
| Orion '91 | 1.6 | 66 | 08.90 - 07.93 | L1E ZETEC SEFI | 4 | 1,3 | PTR5A-13 | 2467 | 25 | LPG 4 | 1511 |
| Orion '91 | 1.6 | 66 | 08.90 - 07.93 | LUJ CVH 2V | 4 | 0,8 | BCPR6ES | 2330 | 12 | LPG 3 | 1498 |
| Orion '91 | 1.6 | 66 | 08.90 - 07.93 | LUK CVH 2V | 4 | 0,8 | BCPR6ES | 2330 | 12 | LPG 3 | 1498 |
| Orion '91 | 1.6 | 77 | 08.90 - 07.93 | LJF CVH EFI | 4 | 1,1 | BCPR6ES-11 | 7121 | 11 | LPG 3 | 1498 |
| Orion '91 | 1.6 | 79 | 08.90 - 07.93 | LJE CVH EFI | 4 | 1,1 | BCPR6ES-11 | 7121 | 11 | LPG 3 | 1498 |
| Orion '91 | 1.8 | 44 | 08.90 - 07.93 | RTE | 4 | █ | Y-910R | 4751 | | D-POWER 3 | 3617 |
| Orion '91 | 1.8 | 44 | 08.90 - 07.93 | RTF | 4 | █ | Y-910R | 4751 | | D-POWER 3 | 3617 |



ℓ kW



Cyl.

Order-
No.LPG/CNG
D-PowerOrder-
No.**FORD**

| | | | | | | | | | | | |
|---------------|-----|-----|---------------|---------------------|---|-----|------------|------|----|------------|------|
| Orion '91 | 1.8 | 44 | 08.90 - 07.93 | RTH | 4 | █ | Y-910R | 4751 | | D-POWER 3 | 3617 |
| Orion '91 | 1.8 | 66 | 08.90 - 07.93 | RFD | 4 | █ | Y-910R | 4751 | | D-POWER 3 | 3617 |
| Orion '91 | 1.8 | 66 | 08.90 - 07.93 | RFK | 4 | █ | Y-910R | 4751 | | D-POWER 3 | 3617 |
| Orion '91 | 1.8 | 77 | 08.90 - 07.93 | RDA ZETEC SEFI | 4 | 1,3 | PTR5A-13 | 2467 | 25 | LPG 4 | 1511 |
| Orion '91 | 1.8 | 96 | 08.90 - 07.93 | RQB ZETEC SEFI | 4 | 1,3 | PTR5A-13 | 2467 | 25 | LPG 4 | 1511 |
| P 100 | 1.6 | 54 | 04.82 - 08.87 | LCR OHC W | 4 | 0,8 | AP6FS | 2710 | | | |
| P 100 | 2.3 | | 82 - | | | █ | Y-924J | 7906 | | D-POWER 1 | 7906 |
| P 100 Pick-Up | 1.8 | 55 | 10.87 - 12.92 | RFA DT | 4 | █ | Y-910R | 4751 | | D-POWER 3 | 3617 |
| P 100 Pick-Up | 2.0 | 57 | 10.87 - 12.92 | NAE OHC W | 4 | 0,8 | APR6FS | 2922 | | | |
| P 100 Turbo | 1.8 | | 89 - | | 4 | █ | Y-910R | 4751 | | D-POWER 3 | 3617 |
| Probe | 2.0 | 85 | 01.93 - 07.97 | FS DOHC 16V SEFI | 4 | 1,1 | BCPR6ES-11 | 7121 | 11 | LPG 3 | 1498 |
| Probe | 2.5 | 120 | 01.93 - 07.97 | KL V6 24V EFI | 6 | 1,1 | ZFR6F-11 | 4291 | | LPG 6 | 1565 |
| Probe GT | 2.2 | 108 | 03.91 - 12.92 | OHC EFI | 4 | 1,1 | ZFR6F-11 | 4291 | | LPG 6 | 1565 |
| Puma '97 | 1.4 | 66 | 06.97 - 12.01 | FHD ZETEC-SE SEFI | 4 | 1,3 | PTR5A-13 | 2467 | 25 | LPG 4 | 1511 |
| Puma '97 | 1.4 | 66 | 06.97 - 12.01 | FHF ZETEC-SE SEFI | 4 | 1,3 | PTR5A-13 | 2467 | 25 | LPG 4 | 1511 |
| Puma '97 | 1.6 | 76 | 06.97 - 12.01 | L1W ZETEC-SE SFI | 4 | 1,3 | PTR5A-13 | 2467 | 25 | LPG 4 | 1511 |
| Puma '97 | 1.7 | 92 | 06.97 - 12.01 | MHA ZETEC-S VCT SFI | 4 | 1,3 | PTR5A-13 | 2467 | 25 | LPG 4 | 1511 |
| Puma '97 | 1.7 | 92 | 06.97 - 12.01 | MHB ZETEC-S VCT SFI | 4 | 1,3 | PTR5A-13 | 2467 | 25 | LPG 4 | 1511 |
| Ranger TD | 2.5 | 105 | | Duratorq | 4 | | only OES | | | | |
| Ranger TD | 3.0 | 115 | | Duratorq | 4 | | only OES | | | | |
| Scorpio '85 | 1.8 | 66 | 05.85 - 10.94 | REC OHC 2V | 4 | 0,8 | APR6FS | 2922 | | | |
| Scorpio '85 | 2.0 | 74 | 05.85 - 10.94 | NE4 OHC 2V | 4 | 0,8 | APR6FS | 2922 | | | |
| Scorpio '85 | 2.0 | 74 | 05.85 - 10.94 | NER OHC 2V | 4 | 0,8 | APR6FS | 2922 | | | |
| Scorpio '85 | 2.0 | 74 | 05.85 - 10.94 | NRC OHC EFI | 4 | 0,8 | APR6FS | 2922 | | | |
| Scorpio '85 | 2.0 | 77 | 05.85 - 10.94 | N8D DOHC 2V | 4 | 0,8 | BCPR6ES | 2330 | 12 | LPG 3 | 1498 |
| Scorpio '85 | 2.0 | 77 | 05.85 - 10.94 | NEL OHC 2V | 4 | 0,8 | APR6FS | 2922 | | | |
| Scorpio '85 | 2.0 | 77 | 05.85 - 10.94 | NEL OHC 2V Cat. | 4 | 0,8 | APR6FS | 2922 | | | |
| Scorpio '85 | 2.0 | 80 | 05.85 - 10.94 | N8B DOHC 2V | 4 | 0,8 | BCPR6ES | 2330 | 12 | LPG 3 | 1498 |
| Scorpio '85 | 2.0 | 85 | 05.85 - 10.94 | N9F DOHC EFI | 4 | 0,8 | BCPR6ES | 2330 | 12 | LPG 3 | 1498 |
| Scorpio '85 | 2.0 | 85 | 05.85 - 10.94 | NRA OHC EFI | 4 | 0,8 | APR6FS | 2922 | | | |
| Scorpio '85 | 2.0 | 85 | 05.85 - 10.94 | NRA OHC EFI Cat. | 4 | 0,8 | APR6FS | 2922 | | | |
| Scorpio '85 | 2.0 | 85 | 05.85 - 10.94 | NRI OHC EFI | 4 | 0,8 | APR6FS | 2922 | | | |
| Scorpio '85 | 2.0 | 88 | 05.85 - 10.94 | N9D DOHC EFI | 4 | 0,8 | BCPR6ES | 2330 | 12 | LPG 3 | 1498 |
| Scorpio '85 | 2.0 | 90 | 05.85 - 10.94 | N9B DOHC EFI | 4 | 0,8 | BCPR6ES | 2330 | 12 | LPG 3 | 1498 |
| Scorpio '85 | 2.4 | 92 | 05.85 - 10.94 | ARD V6 EFI | 6 | 1,0 | BPR6EFS | 3623 | 7 | LPG 5 | 1516 |
| Scorpio '85 | 2.4 | 96 | 05.85 - 10.94 | ARC V6 EFI | 6 | 0,8 | BCPR6ES | 2330 | 12 | LPG 3 | 1498 |
| Scorpio '85 | 2.5 | 51 | 05.85 - 10.94 | STR D | 4 | █ | Y-924J | 7906 | | D-POWER 1 | 7906 |
| Scorpio '85 | 2.5 | 68 | 05.85 - 10.94 | SFA D TURBO | 4 | █ | Y-924J | 7906 | | D-POWER 1 | 7906 |
| Scorpio '85 | 2.5 | 68 | 05.85 - 10.94 | SFB D TURBO | 4 | █ | Y-924J | 7906 | | D-POWER 1 | 7906 |
| Scorpio '85 | 2.5 | | 11.94 - 07.98 | SCB | 4 | █ | Y-741U | 6943 | | D-POWER 20 | 6943 |
| Scorpio '85 | 2.8 | 105 | 05.85 - 10.94 | PR4 V6 EFI | 6 | 0,8 | BPR6ES | 7822 | 2 | LPG 2 | 1497 |
| Scorpio '85 | 2.8 | 107 | 05.85 - 10.94 | PR3 V6 EFI | 6 | 0,8 | BPR6ES | 7822 | 2 | LPG 2 | 1497 |
| Scorpio '85 | 2.8 | 110 | 05.85 - 10.94 | PRE V6 EFI | 6 | 0,8 | BPR6ES | 7822 | 2 | LPG 2 | 1497 |
| Scorpio '85 | 2.9 | 107 | 05.85 - 10.94 | BRD V6 EFI | 6 | 1,0 | BPR6EFS | 3623 | 7 | LPG 5 | 1516 |
| Scorpio '85 | 2.9 | 107 | 05.85 - 10.94 | BRE V6 EFI | 6 | 1,0 | BPR6EFS | 3623 | 7 | LPG 5 | 1516 |
| Scorpio '85 | 2.9 | 107 | 05.85 - 10.94 | BRF V6 EFI | 6 | 1,0 | BPR6EFS | 3623 | 7 | LPG 5 | 1516 |
| Scorpio '85 | 2.9 | 110 | 05.85 - 10.94 | BRC V6 EFI | 6 | 0,8 | BCPR6ES | 2330 | 12 | LPG 3 | 1498 |
| Scorpio '85 | 2.9 | 143 | 05.85 - 10.94 | BOA V6 24V EFI | 6 | 1,1 | BKR6EVX-11 | 3540 | | LPG 1 | 1496 |
| Scorpio '95 | 2.0 | 85 | 10.94 - 06.98 | NSD DOHC 8V SEFI | 4 | 1,1 | PFR6B-11 | 4014 | | PFR7B | 4853 |
| Scorpio '95 | 2.0 | 100 | 10.94 - 06.98 | N3A DOHC 16V SEFI | 4 | 1,1 | PFR6B-11 | 4014 | | PFR7B | 4853 |
| Scorpio '95 | 2.3 | 108 | 10.94 - 06.98 | Y5A 16V SEFI | 4 | 1,1 | BKR6EVX-11 | 3540 | | LPG 1 | 1496 |
| Scorpio '95 | 2.5 | 85 | 10.94 - 06.98 | SCC TCI | 4 | █ | Y-741U | 6943 | | D-POWER 20 | 6943 |



ℓ kW



Cyl.

Order-
No. No.LPG/CNG
D-PowerOrder-
No.**FORD**

| | | | | | | | | | | | |
|-------------|-----|-----|---------------|-------------------|---|-----|------------|------|----|------------|------|
| Scorpio '95 | 2.5 | 92 | 10.94 - 06.98 | SCD TCI | 4 | █ | Y-741U | 6943 | | D-POWER 20 | 6943 |
| Scorpio '95 | 2.9 | 110 | 10.94 - 06.98 | BRG V6 12V SEFI | 6 | 1,0 | BPR6EFS | 3623 | 7 | LPG 5 | 1516 |
| Scorpio '95 | 2.9 | 152 | 10.94 - 06.98 | BOB V6 24V SEFI | 6 | 1,1 | PFR6B-11 | 4014 | | PFR7B | 4853 |
| Sierra '83 | 1.3 | 44 | 08.82 - 01.87 | JCT OHV VV | 4 | 0,8 | APR6FS | 2922 | | | |
| Sierra '83 | 1.6 | 51 | 08.82 - 01.87 | LSDA OHC 2V | 4 | 0,8 | APR6FS | 2922 | | | |
| Sierra '83 | 1.6 | 55 | 08.82 - 01.87 | LCS OHV VV | 4 | 0,8 | APR6FS | 2922 | | | |
| Sierra '83 | 1.6 | 55 | 08.82 - 01.87 | LCT OHV VV | 4 | 0,8 | APR6FS | 2922 | | | |
| Sierra '83 | 1.6 | 55 | 08.82 - 01.87 | LSD OHV 2V | 4 | 0,8 | APR6FS | 2922 | | | |
| Sierra '83 | 1.6 | 55 | 08.82 - 01.87 | LSD OHV 2V Cat. | 4 | 0,8 | APR6FS | 2922 | | | |
| Sierra '83 | 1.8 | 59 | 08.82 - 01.87 | REB OHC 2V | 4 | 0,8 | APR6FS | 2922 | | | |
| Sierra '83 | 1.8 | 66 | 08.82 - 01.87 | REB OHC 2V | 4 | 0,8 | APR6FS | 2922 | | | |
| Sierra '83 | 2.0 | 66 | 08.82 - 01.87 | NYT V6 2V | 6 | 0,8 | BPR6ES | 7822 | 2 | LPG 2 | 1497 |
| Sierra '83 | 2.0 | 67 | 08.82 - 01.87 | NAI OHC 2V | 4 | 0,8 | APR6FS | 2922 | | | |
| Sierra '83 | 2.0 | 69 | 08.82 - 01.87 | NA OHC 2V | 4 | 0,8 | APR6FS | 2922 | | | |
| Sierra '83 | 2.0 | 74 | 08.82 - 01.87 | NE OHC 2V | 4 | 0,8 | APR6FS | 2922 | | | |
| Sierra '83 | 2.0 | 74 | 08.82 - 01.87 | NEI OHC 2V | 4 | 0,8 | APR6FS | 2922 | | | |
| Sierra '83 | 2.0 | 74 | 08.82 - 01.87 | NRD OHC EFI | 4 | 0,8 | APR6FS | 2922 | | | |
| Sierra '83 | 2.0 | 77 | 10.84 - 01.87 | NET OHC 2V | 4 | 0,8 | APR6FS | 2922 | | | |
| Sierra '83 | 2.0 | 77 | 10.84 - 01.87 | NET OHC 2V Cat. | 4 | 0,8 | APR6FS | 2922 | | | |
| Sierra '83 | 2.0 | 85 | 08.82 - 01.87 | NR2 OHC EFI | 4 | 0,8 | APR6FS | 2922 | | | |
| Sierra '83 | 2.0 | 85 | 08.82 - 01.87 | NRB OHC EFI | 4 | 0,8 | APR6FS | 2922 | | | |
| Sierra '83 | 2.0 | 85 | 08.82 - 01.87 | NRB OHC EFI Cat. | 4 | 0,8 | APR6FS | 2922 | | | |
| Sierra '83 | 2.0 | 150 | 08.82 - 01.87 | N5A DOHC COSWORTH | 4 | 0,8 | BCR8ES | 5430 | | | |
| Sierra '83 | 2.3 | 49 | 08.82 - 01.87 | YTT | 4 | █ | Y-924J | 7906 | | D-POWER 1 | 7906 |
| Sierra '83 | 2.3 | 84 | 08.82 - 01.87 | YYT V6 2V | 6 | 0,8 | BPR6ES | 7822 | 2 | LPG 2 | 1497 |
| Sierra '83 | 2.8 | 105 | 08.82 - 01.87 | PR6 V6 EFI | 6 | 0,8 | BPR6ES | 7822 | 2 | LPG 2 | 1497 |
| Sierra '83 | 2.8 | 107 | 08.82 - 01.87 | PR5 V6 EFI | 6 | 0,8 | BPR6ES | 7822 | 2 | LPG 2 | 1497 |
| Sierra '83 | 2.8 | 109 | 08.82 - 01.87 | PRI V6 EFI | 6 | 0,8 | BPR6ES | 7822 | 2 | LPG 2 | 1497 |
| Sierra '83 | 2.8 | 110 | 08.82 - 01.87 | PRT V6 FL | 6 | 0,8 | BPR6ES | 7822 | 2 | LPG 2 | 1497 |
| Sierra '83 | 2.8 | 111 | 08.82 - 01.87 | PR V6 EFI | 6 | 0,8 | BPR6ES | 7822 | 2 | LPG 2 | 1497 |
| Sierra '87 | 1.6 | 53 | 01.87 - 12.92 | LSF OHC 2V | 4 | 0,8 | APR6FS | 2922 | | | |
| Sierra '87 | 1.6 | 55 | 01.87 - 12.92 | LSE OHC 2V | 4 | 0,8 | APR6FS | 2922 | | | |
| Sierra '87 | 1.6 | 55 | 01.87 - 12.92 | LSE OHC 2V Cat. | 4 | 0,8 | APR6FS | 2922 | | | |
| Sierra '87 | 1.6 | 59 | 01.87 - 12.92 | L6B CVH CFI | 4 | 1,1 | BCPR6ES-11 | 7121 | 11 | LPG 3 | 1498 |
| Sierra '87 | 1.8 | 55 | 01.87 - 12.92 | RFA | 4 | █ | Y-910R | 4751 | | D-POWER 3 | 3617 |
| Sierra '87 | 1.8 | 55 | 01.87 - 12.92 | RFB | 4 | █ | Y-910R | 4751 | | D-POWER 3 | 3617 |
| Sierra '87 | 1.8 | 55 | 01.87 - 12.92 | RFL | 4 | █ | Y-910R | 4751 | | D-POWER 3 | 3617 |
| Sierra '87 | 1.8 | 59 | 01.87 - 12.92 | RED OHC 2V Cat. | 4 | 0,8 | APR6FS | 2922 | | | |
| Sierra '87 | 1.8 | 59 | 01.87 - 12.92 | REF OHC 2V | 4 | 0,8 | APR6FS | 2922 | | | |
| Sierra '87 | 1.8 | 63 | 01.87 - 12.92 | R6A CVH CFI | 4 | 1,1 | BCPR6ES-11 | 7121 | 11 | LPG 3 | 1498 |
| Sierra '87 | 1.8 | 64 | 01.87 - 12.92 | R2C CVH 2V | 4 | 1,1 | BCPR6ES-11 | 7121 | 11 | LPG 3 | 1498 |
| Sierra '87 | 1.8 | 66 | 01.87 - 12.92 | R2A CVH 2V | 4 | 1,1 | BCPR6ES-11 | 7121 | 11 | LPG 3 | 1498 |
| Sierra '87 | 1.8 | 66 | 01.87 - 12.92 | RED OHC 2V | 4 | 0,8 | APR6FS | 2922 | | | |
| Sierra '87 | 2.0 | 74 | 01.87 - 12.92 | N4B OHC EFI | 4 | 0,8 | APR6FS | 2922 | | | |
| Sierra '87 | 2.0 | 74 | 01.87 - 12.92 | NE5 OHC 2V | 4 | 0,8 | APR6FS | 2922 | | | |
| Sierra '87 | 2.0 | 74 | 01.87 - 12.92 | NEJ OHC 2V | 4 | 0,8 | APR6FS | 2922 | | | |
| Sierra '87 | 2.0 | 77 | 01.87 - 12.92 | N8C DOHC 2V | 4 | 0,8 | BCPR6ES | 2330 | 12 | LPG 3 | 1498 |
| Sierra '87 | 2.0 | 77 | 01.87 - 12.92 | NES OHC 2V | 4 | 0,8 | APR6FS | 2922 | | | |
| Sierra '87 | 2.0 | 77 | 01.87 - 12.92 | NES OHC 2V Cat. | 4 | 0,8 | APR6FS | 2922 | | | |
| Sierra '87 | 2.0 | 80 | 01.87 - 12.92 | N8A DOHC 2V | 4 | 0,8 | BCPR6ES | 2330 | 12 | LPG 3 | 1498 |
| Sierra '87 | 2.0 | 85 | 01.87 - 12.92 | N4A OHC EFI | 4 | 0,8 | APR6FS | 2922 | | | |
| Sierra '87 | 2.0 | 85 | 01.87 - 12.92 | N4A OHC EFI Cat. | 4 | 0,8 | APR6FS | 2922 | | | |



ℓ kW

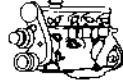

Cyl.

Order-
No.VLINE
No.LPG/CNG
D-PowerOrder-
No.**FORD**

| | | | | | | | | | | | | |
|-------------------------------|-----|-----|---------------|--------------------|---|-----|------------|------|----|------------|------|--|
| Sierra '87 | 2.0 | 85 | 01.87 - 12.92 | N4I OHC EFI | 4 | 0,8 | APR6FS | 2922 | | | | |
| Sierra '87 | 2.0 | 85 | 01.87 - 12.92 | N9E DOHC EFI | 4 | 0,8 | BCPR6ES | 2330 | 12 | LPG 3 | 1498 | |
| Sierra '87 | 2.0 | 88 | 01.87 - 12.92 | N9C DOHC EFI | 4 | 0,8 | BCPR6ES | 2330 | 12 | LPG 3 | 1498 | |
| Sierra '87 | 2.0 | 90 | 01.87 - 12.92 | N9A DOHC EFI | 4 | 0,8 | BCPR6ES | 2330 | 12 | LPG 3 | 1498 | |
| Sierra '87 | 2.0 | 150 | 01.87 - 12.92 | N5B DOHC COSWORTH | 4 | 0,9 | R7234-9 | 5487 | | | | |
| Sierra '87 | 2.0 | 162 | 01.87 - 12.92 | N5C DOHC COSWORTH | 4 | 1,1 | PFR7B-11 | 5667 | | PFR8B | 2781 | |
| Sierra '87 | 2.0 | 162 | 01.87 - 12.92 | N5D DOHC COSWORTH | 4 | 1,1 | PFR7B-11 | 5667 | | PFR8B | 2781 | |
| Sierra '87 | 2.3 | 49 | 01.87 - 12.92 | YTR | 4 | █ | Y-924J | 7906 | | D-POWER 1 | 7906 | |
| Sierra '87 | 2.8 | 105 | 01.87 - 12.92 | PR8 V6 EFI | 6 | 0,8 | BPR6ES | 7822 | 2 | LPG 2 | 1497 | |
| Sierra '87 | 2.8 | 107 | 01.87 - 12.92 | PR7 V6 EFI | 6 | 0,8 | BPR6ES | 7822 | 2 | LPG 2 | 1497 | |
| Sierra '87 | 2.8 | 110 | 01.87 - 12.92 | PRG V6 FI | 6 | 0,8 | BPR6ES | 7822 | 2 | LPG 2 | 1497 | |
| Sierra '87 | 2.9 | 107 | 01.87 - 12.92 | B4B V6 EFI | 6 | 1,0 | BPR6EFS | 3623 | 7 | LPG 5 | 1516 | |
| Sierra '87 | 2.9 | 107 | 01.87 - 12.92 | B4C V6 EFI | 6 | 1,0 | BPR6EFS | 3623 | 7 | LPG 5 | 1516 | |
| Sierra '87 | 2.9 | 110 | 01.87 - 12.92 | B4A V6 EFI | 6 | 0,8 | BCPR6ES | 2330 | 12 | LPG 3 | 1498 | |
| S-MAX/Galaxy 2006.5 | 2.0 | 96 | 03.06 - | AZWA Duratorq-TDCi | 4 | █ | Y-525J | 4090 | | D-POWER 35 | 4090 | |
| S-MAX/Galaxy 2006.5 | 2.0 | 103 | 03.06 - | QXWA Duratorq-TDCi | 4 | █ | Y-525J | 4090 | | D-POWER 35 | 4090 | |
| S-MAX/Galaxy 2006.5 | 2.0 | 103 | 03.06 - | QXWB ohne DPF | 4 | █ | Y-525J | 4090 | | D-POWER 35 | 4090 | |
| S-MAX/Galaxy 2006.5 | 2.3 | 118 | 08.07 - | SEWA Duratec-HE | 4 | 1,3 | ILTR5A-13G | 3811 | | ILTR6A-13G | 3789 | |
| S-MAX/Galaxy 2006.5 Flexifuel | 2.0 | 107 | 03.06 - | AOWA Duratec-HE | 4 | 1,3 | ITR6F13 | 4477 | | LPG 5 | 1516 | |
| Sportka | 1.6 | | 05.03 - | Duratec Rocam | 4 | 1,3 | TR5B-13 | 4559 | | | | |
| Streetka | 1.6 | 70 | 01.03 - 07.05 | CDRA Duratec 8V | 4 | 1,3 | TR5B-13 | 4559 | | LPG 4 | 1511 | |
| Streetka | 1.6 | 70 | 01.03 - 07.05 | CDRB Duratec 8V | 4 | 1,3 | PTR5A-13 | 2467 | 25 | LPG 4 | 1511 | |
| Tourneo Connect | 1.8 | 55 | 06.02 - | BHPA Endura-DI | 4 | █ | Y-524J | 4520 | | D-POWER 27 | 4520 | |
| Tourneo Connect | 1.8 | 66 | 06.02 - | HCPA Duratorq-TDCi | 4 | █ | Y-524J | 4520 | | D-POWER 27 | 4520 | |
| Tourneo Connect | 1.8 | 66 | 06.02 - | HCPB Duratorq-TDCi | 4 | █ | Y-524J | 4520 | | D-POWER 27 | 4520 | |
| Tourneo Connect | 1.8 | 81 | 06.02 - | RWPA Duratorq-TDCi | 4 | █ | Y-524J | 4520 | | D-POWER 27 | 4520 | |
| Tourneo Connect | 1.8 | 85 | 06.02 - | EYPA ZETEC-E SFI | 4 | 1,3 | PTR5A-13 | 2467 | 25 | LPG 4 | 1511 | |
| Tourneo Connect | 1.8 | 85 | 06.02 - | EYPC ZETEC-E SFI | 4 | 1,0 | TR5A-10 | 0005 | | LPG 4 | 1511 | |
| Transit Connect | 1.8 | 55 | 06.02 - | BHPA Endura-DI | 4 | █ | Y-524J | 4520 | | D-POWER 27 | 4520 | |
| Transit Connect | 1.8 | 66 | 06.02 - | HCPA Duratorq-TDCi | 4 | █ | Y-524J | 4520 | | D-POWER 27 | 4520 | |
| Transit Connect | 1.8 | 66 | 06.02 - | HCPB Duratorq-TDCi | 4 | █ | Y-524J | 4520 | | D-POWER 27 | 4520 | |
| Transit Connect | 1.8 | 81 | 06.02 - | RWPA Duratorq-TDCi | 4 | █ | Y-524J | 4520 | | D-POWER 27 | 4520 | |
| Transit Connect | 1.8 | 85 | 06.02 - | EYPA ZETEC-E SFI | 4 | 1,3 | PTR5A-13 | 2467 | 25 | LPG 4 | 1511 | |
| Transit Connect | 1.8 | 85 | 06.02 - | EYPC ZETEC-E SFI | 4 | 1,0 | TR5A-10 | 0005 | | LPG 4 | 1511 | |
| Transit '85 | 1.6 | 48 | 08.83 - 12.85 | B OHC VV | 4 | 0,8 | AP6FS | 2710 | | | | |
| Transit '85 | 2.0 | 55 | 08.83 - 12.85 | C OHC VV | 4 | 0,8 | AP6FS | 2710 | | | | |
| Transit '85 | 2.0 | 57 | 08.83 - 12.85 | C OHC VV | 4 | 0,8 | AP6FS | 2710 | | | | |
| Transit '85 | 2.4 | 46 | 08.83 - 12.85 | 4AA YORK-D | 4 | █ | Y-208T | 1250 | | | | |
| Transit '85 | 3.0 | 74 | 08.83 - 12.85 | HX ESX 1V | 6 | 0,8 | BPR6ES | 7822 | 2 | LPG 2 | 1497 | |
| Transit '86 | 1.6 | 46 | 01.86 - 07.91 | LAC OHC VV | 4 | 0,8 | APR6FS | 2922 | | | | |
| Transit '86 | 1.6 | 46 | 01.86 - 07.91 | LAT OHC VV | 4 | 0,8 | APR6FS | 2922 | | | | |
| Transit '86 | 2.0 | 55 | 01.86 - 07.91 | NAV OHC VV | 4 | 0,8 | APR6FS | 2922 | | | | |
| Transit '86 | 2.0 | 56 | 01.86 - 07.91 | NAW OHC | 4 | 0,8 | APR6FS | 2922 | | | | |
| Transit '86 | 2.0 | 56 | 01.86 - 07.91 | NAX OHC | 4 | 0,8 | APR6FS | 2922 | | | | |
| Transit '86 | 2.0 | 57 | 01.86 - 07.91 | N6T OHC CFI | 4 | 0,8 | APR6FS | 2922 | | | | |
| Transit '86 | 2.0 | 57 | 01.86 - 07.91 | NAT OHC VV | 4 | 0,8 | APR6FS | 2922 | | | | |
| Transit '86 | 2.0 | 60 | 01.86 - 07.91 | N6TS OHC CFI | 4 | 0,8 | APR6FS | 2922 | | | | |
| Transit '86 | 2.9 | 110 | 01.86 - 07.91 | B4T V6 EFI | 6 | 0,8 | BCPR6ES | 2330 | 12 | LPG 3 | 1498 | |
| Transit '86 | 3.0 | 78 | 01.86 - 07.91 | HXC V6 ESX 1V | 6 | 0,8 | BPR6ES | 7822 | 2 | LPG 2 | 1497 | |
| Transit '92 | 2.0 | 66 | 08.91 - 07.94 | NBA OHC 2V | 4 | 0,8 | APR6FS | 2922 | | | | |
| Transit '92 | 2.0 | 72 | 08.91 - 07.94 | NCA OHC EFI | 4 | 0,8 | APR6FS | 2922 | | | | |
| Transit '92 | 2.9 | 107 | 08.91 - 07.94 | BRT V6 EFI | 6 | 1,1 | BCPR6ES-11 | 7121 | 11 | LPG 3 | 1498 | |



l kW



Cyl.

Order-
No. No.LPG/CNG
D-PowerOrder-
No.**FORD**

| | | | | | | | | | | | |
|-----------------------------------|-----|-----|---------------|------------------|---|-----|------------|------|--|------------|------|
| Transit '95 | 2.0 | 84 | 08.94 - 07.00 | NSF DOHC 8V SEFI | 4 | 1,1 | BKR7EVX-11 | 4685 | | BKR8EIX | 2668 |
| Transit '95 | 2.0 | 84 | 08.94 - 07.00 | NSG DOHC 8V SEFI | 4 | 1,1 | BKR7EVX-11 | 4685 | | BKR8EIX | 2668 |
| Transit '95 | 2.0 | 84 | 08.94 - 07.00 | NSH DOHC-8V SEFI | 4 | 1,1 | BKR7EVX-11 | 4685 | | BKR8EIX | 2668 |
| Transit 2000.5 (Hinterradantrieb) | 2.3 | 107 | 01.00 - 05.06 | E5FA | 4 | 1,1 | PFR6B-11 | 4014 | | PFR7B | 4853 |
| Transit 2000.5 (Hinterradantrieb) | 2.3 | 107 | 01.00 - 05.06 | E5FC | 4 | 1,1 | PFR6B-11 | 4014 | | PFR7B | 4853 |
| Transit 2000.5 (Hinterradantrieb) | 2.4 | 55 | 01.00 - 05.06 | F4FA | 4 | █ | Y-525J | 4090 | | D-POWER 35 | 4090 |
| Transit 2000.5 (Hinterradantrieb) | 2.4 | 66 | 01.00 - 05.06 | D2FA | 4 | █ | Y-525J | 4090 | | D-POWER 35 | 4090 |
| Transit 2000.5 (Hinterradantrieb) | 2.4 | 66 | 01.00 - 05.06 | D2FB | 4 | █ | Y-525J | 4090 | | D-POWER 35 | 4090 |
| Transit 2000.5 (Hinterradantrieb) | 2.4 | 85 | 01.00 - 05.06 | FXFA | 4 | █ | Y-525J | 4090 | | D-POWER 35 | 4090 |
| Transit 2000.5 (Hinterradantrieb) | 2.4 | 88 | 01.00 - 05.06 | D4FA | 4 | █ | Y-525J | 4090 | | D-POWER 35 | 4090 |
| Transit 2000.5 (Hinterradantrieb) | 2.4 | 92 | 01.00 - 05.06 | DOFA | 4 | █ | Y-525J | 4090 | | D-POWER 35 | 4090 |
| Transit 2000.5 (Hinterradantrieb) | 2.4 | 101 | 01.00 - 05.06 | H9FA | 4 | █ | Y-525J | 4090 | | D-POWER 35 | 4090 |
| Transit 2000.5 (Vorderradantrieb) | 2.0 | 55 | 08.00 - 05.06 | D3FA | 4 | █ | Y-525J | 4090 | | D-POWER 35 | 4090 |
| Transit 2000.5 (Vorderradantrieb) | 2.0 | 63 | 08.00 - 05.06 | F3FA | 4 | █ | Y-525J | 4090 | | D-POWER 35 | 4090 |
| Transit 2000.5 (Vorderradantrieb) | 2.0 | 74 | 08.00 - 05.06 | ABFA | 4 | █ | Y-525J | 4090 | | D-POWER 35 | 4090 |
| Transit 2000.5 (Vorderradantrieb) | 2.0 | 92 | 08.00 - 05.06 | FIFA | 4 | █ | Y-525J | 4090 | | D-POWER 35 | 4090 |
| Transit 2006.5 (Hinterradantrieb) | 2.4 | 74 | 04.06 - | PHFA | 4 | █ | Y-525J | 4090 | | D-POWER 35 | 4090 |
| Transit 2006.5 (Hinterradantrieb) | 2.4 | 85 | 04.06 - | JXFA | 4 | █ | Y-525J | 4090 | | D-POWER 35 | 4090 |
| Transit 2006.5 (Hinterradantrieb) | 2.4 | 103 | 04.06 - | H9FB | 4 | █ | Y-525J | 4090 | | D-POWER 35 | 4090 |
| Transit 2006.5 (Vorderradantrieb) | 2.2 | 63 | 04.06 - | P8FA | 4 | █ | Y-525J | 4090 | | D-POWER 35 | 4090 |
| Transit 2006.5 (Vorderradantrieb) | 2.2 | 81 | 04.06 - | QVFA | 4 | █ | Y-525J | 4090 | | D-POWER 35 | 4090 |
| Transit 2006.5 (Vorderradantrieb) | 2.2 | 96 | 04.06 - | QWFA | 4 | █ | Y-525J | 4090 | | D-POWER 35 | 4090 |
| Windstar | 3.0 | 109 | 10.94 - | V6 SEFI | 6 | 1,0 | TR5 | 2238 | | LPG 5 | 1516 |

FORD (USA)

| | | | | | | | | | | | |
|-----------|-----|-----|---------|------------------|---|-----|-------|------|--|---------|------|
| Bronco | 4.9 | | 80 - 82 | E | 6 | 1,1 | WR5 | 1071 | | WR5IX | 7510 |
| Bronco | 4.9 | | 83 - 86 | Y | 6 | 1,1 | WR5 | 1071 | | WR5IX | 7510 |
| Bronco | 4.9 | | 87 - 95 | Y EFI | 6 | 1,1 | WR4-1 | 4258 | | | |
| Bronco | 5.0 | | 80 - 85 | F | 8 | 1,1 | UR4 | 4762 | | UR5IX | 7177 |
| Bronco | 5.0 | | 85 - 96 | N EFI | 8 | 1,1 | UR4 | 4762 | | UR5IX | 7177 |
| Bronco | 5.8 | | 80 - 85 | G | 8 | 1,1 | UR4 | 4762 | | UR5IX | 7177 |
| Bronco | 5.8 | | 88 - 95 | H EFI | 8 | 1,3 | UR5 | 2139 | | UR6IX | 7348 |
| Bronco | 5.8 | | 85 - 86 | H Vergaser/Carb. | 8 | 1,3 | UR5 | 2139 | | UR6IX | 7348 |
| Bronco | 5.8 | | 87 - 87 | H Vergaser/Carb. | 8 | 1,1 | UR4 | 4762 | | UR5IX | 7177 |
| Bronco II | 2.0 | | 84 - 84 | C | 4 | 1,0 | TR5 | 2238 | | LPG 5 | 1516 |
| Bronco II | 2.3 | | 88 - 88 | A EFI | 4 | 1,1 | TR5-1 | 2321 | | TR5-1IX | 7243 |
| Bronco II | 2.3 | | 84 - 85 | A Vergaser/Carb. | 4 | 1,1 | TR5-1 | 2321 | | TR5-1IX | 7243 |
| Bronco II | 2.8 | | 83 - 85 | S | 6 | 1,0 | TR5 | 2238 | | LPG 5 | 1516 |
| Bronco II | 2.9 | | 86 - 90 | T EFI | 6 | 1,0 | TR5 | 2238 | | LPG 5 | 1516 |
| Bronco II | 4.0 | | 90 - | X EFI | 6 | 1,5 | TR55 | 1048 | | LPG 5 | 1516 |
| GT | 5.4 | 368 | 09.06 - | | 8 | 1,0 | TR6 | 6078 | | LPG 5 | 1516 |
| LTD | 3.3 | | 83 - | X 1 bbl CID200 | 6 | 1,1 | WR5 | 1071 | | WR5IX | 7510 |
| LTD | 3.8 | | 83 - | 3 2 bbl CID232 | 6 | 1,0 | TR5 | 2238 | | LPG 5 | 1516 |
| LTD | 4.2 | | 80 - | C 1 bbl CID256 | 6 | 1,1 | WR5 | 1071 | | WR5IX | 7510 |
| LTD | 4.2 | | 81 - 82 | D 2 bbl CID255 | 8 | 1,5 | UR45 | 2451 | | UR5IX | 7177 |
| LTD | 5.8 | | 80 - 81 | G 2 bbl CID351 | 8 | 1,5 | UR45 | 2451 | | UR5IX | 7177 |
| LTD | 5.8 | | 81 - 83 | G V V CID351 | 8 | 1,1 | UR4 | 4762 | | UR5IX | 7177 |
| Mustang | 3.3 | | 80 - 82 | B 1 bbl CID200 | 6 | 1,1 | WR5 | 1071 | | WR5IX | 7510 |
| Mustang | 3.8 | | 03 - | V6 | 6 | 1,5 | TR55 | 1048 | | LPG 5 | 1516 |
| Mustang | 3.8 | | 83 - | 3 2 bbl CID232 | 6 | 1,0 | TR5 | 2238 | | LPG 5 | 1516 |
| Mustang | 4.0 | | 05 - | V6 | 6 | 1,1 | TR5-1 | 2321 | | TR5-1IX | 7243 |
| Mustang | 4.2 | | 80 - 82 | D 2 bbl CID255 | 8 | 1,5 | UR45 | 2451 | | UR5IX | 7177 |



ℓ kW



Cyl.

Order-
No. No.

VLINE

LPG/CNG
D-PowerOrder-
No.**FORD (USA)**

| | | | | | | | | | | | |
|------------------|-----|--|--------|--------------------------|---|-----|-----------|------|----|----------|------|
| Mustang | 4.6 | | 03- | V8 | 8 | 1,5 | TR55 | 1048 | | LPG 5 | 1516 |
| Mustang | 5.0 | | 83- | F 4 bbl CID302 | 8 | 1,1 | UR4 | 4762 | | UR5IX | 7177 |
| Mustang (Mexico) | 3.0 | | 06- | V6 24V DOHC | 6 | 1,5 | TR55 | 1048 | | LPG 5 | 1516 |
| Taurus | 3.0 | | 96- 99 | N SHO V8 SFI | 8 | 1,0 | TR5 | 2238 | | LPG 5 | 1516 |
| Taurus | 3.0 | | 96- 99 | S DOHC V6 SFI | 6 | 1,5 | TR55 | 1048 | | LPG 5 | 1516 |
| Taurus | 3.0 | | 92- 99 | U OHV V6 SFI | 6 | 1,0 | TR5 | 2238 | | LPG 5 | 1516 |
| Taurus | 3.0 | | 89- 95 | Y DOHC V6 SFI | 6 | 1,1 | PFR5G-11 | 2647 | | PFR6G-11 | 5555 |
| Taurus | 3.2 | | 93- 95 | P SHO V6 SFI | 6 | 1,1 | PFR5G-11 | 2647 | | PFR6G-11 | 5555 |
| Thunderbird | 3.3 | | 80- 82 | B 1 bbl CID200 | 6 | 1,1 | WR5 | 1071 | | WR5IX | 7510 |
| Thunderbird | 3.8 | | 82- | 3 2 bbl CID232 | 6 | 0,9 | FR4 | 5188 | | | |
| Thunderbird | 3.8 | | 83- | 3 2 bbl CID232 | 6 | 1,0 | TR5 | 2238 | | LPG 5 | 1516 |
| Thunderbird | 3.8 | | 88- 97 | 4 EFI V6 EFI | 6 | 1,5 | TR55-1 | 6674 | | TR55-1IX | 7316 |
| Thunderbird | 3.8 | | 89- 95 | R EFI V6 EFISupercharged | 6 | 1,5 | TR55-1 | 6674 | | TR55-1IX | 7316 |
| Thunderbird | 3.9 | | - 02 | A EFI V8 DOHC | 8 | 1,1 | BKR5ES-11 | 2382 | 33 | LPG 1 | 1496 |
| Thunderbird | 3.9 | | 03- | A EFI V8 DOHC | 8 | 1,0 | FR5AP-11 | 5463 | | | |
| Thunderbird | 4.2 | | 80- 82 | D 2 bbl, V V CID255 | 8 | 1,5 | UR45 | 2451 | | UR5IX | 7177 |
| Thunderbird | 4.6 | | 94- 97 | W EFI V8 SOHC | 8 | 1,5 | TR55 | 1048 | | LPG 5 | 1516 |
| Thunderbird | 5.0 | | 83- | F 4 bbl CID302 | 8 | 1,1 | UR4 | 4762 | | UR5IX | 7177 |
| Thunderbird | 5.0 | | 86- 88 | F EFI V8 | 8 | 1,5 | TR55-1 | 6674 | | TR55-1IX | 7316 |
| Thunderbird | 5.0 | | 91- 93 | T EFI V8 H O | 8 | 1,5 | UR45 | 2451 | | UR5IX | 7177 |

FREIGHTROVER

| | | | | | | | | | | | |
|-----------------|-----|--|-------------|--------------------|---|---|--------|------|--|-----------|------|
| Sherpa D | 2.0 | | 05.86-03.91 | Perkins - Prima 65 | 4 | █ | Y-924J | 7906 | | D-POWER 1 | 7906 |
| Sherpa Van DI D | 2.5 | | 01.87- | | 4 | █ | Y-924J | 7906 | | D-POWER 1 | 7906 |

FSO

| | | | | | | | | | | | |
|----------------|-----|----|--------|--------------|---|-----|--------|------|----|-----------|------|
| 126 BIS | 0.7 | 19 | 87- | | 4 | 0,8 | BPR6ES | 7822 | 2 | LPG 2 | 1497 |
| Pick-Up | 1.5 | | 86- 89 | | 4 | 0,7 | BP6ES | 7811 | 4 | LPG 2 | 1497 |
| Polonez | 1.4 | 75 | 09.93- | 16DOHC Rover | 4 | 0,8 | BKR6ES | 3783 | 28 | LPG 1 | 1496 |
| Polonez | 1.5 | 60 | 07.95- | Cat. | 4 | | BP6ET | 1263 | | LPG 2 | 1497 |
| Polonez | 1.6 | 64 | 05.87- | | 4 | 0,7 | BP6ES | 7811 | 4 | LPG 2 | 1497 |
| Polonez | 1.6 | 64 | 07.95- | Cat. | 4 | | BP6ET | 1263 | | LPG 2 | 1497 |
| Polonez 1600 | 1.6 | 64 | 87- | | 4 | 0,8 | BP7ES | 2412 | | BPR8EIX | 6684 |
| Polonez Caro D | 1.9 | 51 | 10.92- | XUD Kat. | 4 | █ | Y-924J | 7906 | | D-POWER 1 | 7906 |
| Polonez D | 1.6 | 37 | 01.86- | VW - Motor | 4 | █ | Y-918J | 6285 | | D-POWER 2 | 6285 |

GAZ (VOLGA)

| | | | | | | | | | | | |
|-----------------|-----|-----|-----|-------------|---|-----|-----------|------|----|-------|------|
| Gazel | 2.5 | 119 | 07- | 3M3-4052 | 4 | 0,9 | BPR5ES | 7422 | 6 | LPG 2 | 1497 |
| Gazel | 2.7 | 105 | 07- | 3M3-409 | 4 | 0,9 | BPR5ES | 7422 | 6 | LPG 2 | 1497 |
| Gazel Euro3 | 2.5 | 119 | 07- | 3M3-405.24 | 4 | 0,8 | BKR5ES | 2460 | 35 | LPG 1 | 1496 |
| Gazel Euro3 | 2.7 | 105 | 07- | 3M3-409.10 | 4 | 0,8 | BKR5ES | 2460 | 35 | LPG 1 | 1496 |
| Sobol | 2.5 | 119 | 07- | 3M3-4052 | 4 | 0,9 | BPR5ES | 7422 | 6 | LPG 2 | 1497 |
| Sobol | 2.7 | 105 | 07- | 3M3-409 | 4 | 0,9 | BPR5ES | 7422 | 6 | LPG 2 | 1497 |
| Sobol Euro3 | 2.5 | 119 | 07- | 3M3-405.24 | 4 | 0,8 | BKR5ES | 2460 | 35 | LPG 1 | 1496 |
| Sobol Euro3 | 2.7 | 105 | 07- | 3M3-409.10 | 4 | 0,8 | BKR5ES | 2460 | 35 | LPG 1 | 1496 |
| Volga | 2.7 | 105 | 07- | 3M3-409 | 4 | 0,9 | BPR5ES | 7422 | 6 | LPG 2 | 1497 |
| Volga Euro3 | 2.7 | 105 | 07- | 3M3-409.10 | 4 | 0,8 | BKR5ES | 2460 | 35 | LPG 1 | 1496 |
| Volga 31105-501 | 2.4 | 110 | 06- | DCC | | 1,1 | LZTR4A-11 | 5444 | | | |
| Volga 3111 | 2.3 | 107 | 00- | 3M3-4062.10 | 4 | 0,9 | BPR5ES | 7422 | 6 | LPG 2 | 1497 |
| Volga 3111 | 2.5 | 112 | 00- | 3M3-4052.10 | 4 | 0,9 | BPR5ES | 7422 | 6 | LPG 2 | 1497 |



l kW

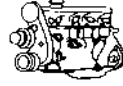

Cyl.

Order-
No. No.LPG/CNG
D-PowerOrder-
No.**HINO**

| | | | | | | | | | | | |
|---------------|-----|----|---------------|-----|---|--------|------|--|--|--|--|
| Ranger (3B) D | 3.4 | 70 | 01.83 - 07.88 | 3 B | 4 | Y-197R | 2188 | | | | |
| Ranger (B) D | 3.0 | 60 | 01.83 - 07.88 | B | 4 | Y-197R | 2188 | | | | |

HOMMEL

| | | | | | | | | | | |
|-------------------|-----|-----|------|-----------|---|--------|------|----|-------|------|
| Berlinette RS 16V | 2.0 | 123 | 98 - | XU10.J4RS | 4 | BKR6EK | 2288 | 20 | LPG 1 | 1496 |
|-------------------|-----|-----|------|-----------|---|--------|------|----|-------|------|

HONDA

| | | | | | | | | | | |
|------------------------------------|-----|-----|---------------|------------|---|------------------|------|----|-------|------|
| Accord 1,6 SJ-3320C1..(3HM) | 1.6 | 59 | 02.81 - | EL1 | 4 | 0,8 BPR6ES | 7822 | 2 | LPG 2 | 1497 |
| Accord 1,6 SJ3320C..(3HM) | 1.6 | 59 | 80 - | EL | 4 | 0,8 BPR6ES | 7822 | 2 | LPG 2 | 1497 |
| Accord 1,6 SJ3420C..(3HM) | 1.6 | 59 | 80 - | EL | 4 | 0,8 BPR6ES | 7822 | 2 | LPG 2 | 1497 |
| Accord 1,6 SJ-3420C1..(3HM) | 1.6 | 59 | 81 - | EL1 | 4 | 0,8 BPR6ES | 7822 | 2 | LPG 2 | 1497 |
| Accord 1,6 SJ5320C..(5MT) | 1.6 | 59 | 80 - | EL | 4 | 0,8 BPR6ES | 7822 | 2 | LPG 2 | 1497 |
| Accord 1,6 SJ-5320C1..(5MT) | 1.6 | 59 | 81 - | EL1 | 4 | 0,8 BPR6ES | 7822 | 2 | LPG 2 | 1497 |
| Accord 1,6 SJ5330C.. Servo | 1.6 | 59 | 80 - | EL | 4 | 0,8 BPR6ES | 7822 | 2 | LPG 2 | 1497 |
| Accord 1,6 SJ5420C..(5MT) | 1.6 | 59 | 80 - | EL | 4 | 0,8 BPR6ES | 7822 | 2 | LPG 2 | 1497 |
| Accord 1,6 SJ-5420C1..(5MT) | 1.6 | 59 | 81 - | EL1 | 4 | 0,8 BPR6ES | 7822 | 2 | LPG 2 | 1497 |
| Accord 1,6 SY3330C..(3HM) | 1.6 | 59 | 82 - 82 | EL | 4 | 0,8 BPR6EY | 6427 | | LPG 2 | 1497 |
| Accord 1,6 SY3430C..(3HM) | 1.6 | 59 | 82 - 82 | EL | 4 | 0,8 BPR6EY | 6427 | | LPG 2 | 1497 |
| Accord 1,6 SY5320C..(5MT)L | 1.6 | 59 | 82 - 82 | EL | 4 | 0,8 BPR6EY | 6427 | | LPG 2 | 1497 |
| Accord 1,6 SY5330C..(5MT) | 1.6 | 59 | 82 - 82 | EL | 4 | 0,8 BPR6EY | 6427 | | LPG 2 | 1497 |
| Accord 1,6 SY5420C..(5MT)L | 1.6 | 59 | 82 - 82 | EL | 4 | 0,8 BPR6EY | 6427 | | LPG 2 | 1497 |
| Accord 1,6 SY5430C..(5MT) | 1.6 | 59 | 82 - 82 | EL | 4 | 0,8 BPR6EY | 6427 | | LPG 2 | 1497 |
| Accord 1,6 2D AC-5320C..(MT) | 1.6 | 65 | 84 - | EZ | 4 | 1,1 BPR6ES-11 | 4824 | 13 | LPG 2 | 1497 |
| Accord 1,6 2D AC-5330C..(MT) | 1.6 | 65 | 84 - | EZ | 4 | 1,1 BPR6ES-11 | 4824 | 13 | LPG 2 | 1497 |
| Accord 1,6 2D AC-7330C..(AT) | 1.6 | 65 | 84 - | EZ | 4 | 1,1 BPR6ES-11 | 4824 | 13 | LPG 2 | 1497 |
| Accord 1,6 4D AC-5430C..(MT) | 1.6 | 65 | 84 - | EZ | 4 | 0,8 BPR6ES | 7822 | 2 | LPG 2 | 1497 |
| Accord 1,6 4D AC-7430C..(AT) | 1.6 | 65 | 84 - | EZ | 4 | 0,8 BPR6ES | 7822 | 2 | LPG 2 | 1497 |
| Accord 1,6 L CA-45200C..(MT) | 1.6 | 65 | 86 - | A16A1 | 4 | 1,1 BPR6EY-11 | 4228 | 10 | LPG 2 | 1497 |
| Accord 1,6 L CA-46200C..(AT) | 1.6 | 65 | 86 - | A16A1 | 4 | 1,1 BPR6EY-11 | 4228 | 10 | LPG 2 | 1497 |
| Accord 1,8 2D AD-5330C..(MT) | 1.8 | 74 | 84 - | ET1 | 4 | 1,1 BPR6EY-11 | 4228 | 10 | LPG 2 | 1497 |
| Accord 1,8 2D AD-7330C..(AT) | 1.8 | 74 | 84 - | ET1 | 4 | 1,1 BPR6EY-11 | 4228 | 10 | LPG 2 | 1497 |
| Accord 1,8 4D AD-5430C..(MT) | 1.8 | 74 | 84 - | ET1 | 4 | 1,1 BPR6EY-11 | 4228 | 10 | LPG 2 | 1497 |
| Accord 1,8 4D AD-7430C..(AT) | 1.8 | 74 | 84 - | ET1 | 4 | 1,1 BPR6EY-11 | 4228 | 10 | LPG 2 | 1497 |
| Accord 1,8 i/iLS CE7 | 1.8 | 85 | 96 - 10.98 | F18A3 | 4 | 1,1 ZFR6F-11 | 4291 | | LPG 6 | 1565 |
| Accord 1,8 iS CG8 | 1.8 | 100 | 99 - 02.03 | F18B2 | 4 | 1,1 ZFR6F-11 | 4291 | | LPG 6 | 1565 |
| Accord 2,0 CB3..(MT/AT) | 2.0 | 66 | 90 - 05.93 | F20A2 Cat. | 4 | 1,1 ZFR6F-11 | 4291 | | LPG 6 | 1565 |
| Accord 2,0 CB3..(MT/AT) | 2.0 | 66 | 90 - 05.93 | F20A6 | 4 | 1,1 ZFR6F-11 | 4291 | | LPG 6 | 1565 |
| Accord 2,0 EX CA-55300C..(5MT) | 2.0 | 75 | 86 - | A20A1 Cat. | 4 | 1,1 BPR6EY-11 | 4228 | 10 | LPG 2 | 1497 |
| Accord 2,0 EX CA-55300C..(MT) | 2.0 | 78 | 86 - | A20A2 | 4 | 1,1 BPR6EY-11 | 4228 | 10 | LPG 2 | 1497 |
| Accord 2,0 EX CA-56300C..(4AT) | 2.0 | 76 | 86 - | A20A1 Cat. | 4 | 1,1 BPR6EY-11 | 4228 | 10 | LPG 2 | 1497 |
| Accord 2,0 EX CA-56300C..(AT) | 2.0 | 78 | 86 - | A20A2 | 4 | 1,1 BPR6EY-11 | 4228 | 10 | LPG 2 | 1497 |
| Accord 2,0 EXi CA-55400C..(MT) | 2.0 | 90 | 86 - | A20A4 | 4 | 1,1 BPR6EY-11 | 4228 | 10 | LPG 2 | 1497 |
| Accord 2,0 EXi CA-56400C..(AT) | 2.0 | 90 | 86 - | A20A4 | 4 | 1,1 BPR6EY-11 | 4228 | 10 | LPG 2 | 1497 |
| Accord 2,0 S,LS,ES CC7..(MT/AT) | 2.0 | 96 | 93 - | F20Z1 | 4 | 1,1 ZFR6F-11 | 4291 | | LPG 6 | 1565 |
| Accord 2,0i CC7..(MT) | 2.0 | 85 | 93 - | F30Z2 | 4 | 1,1 ZFR6F-11 | 4291 | | LPG 6 | 1565 |
| Accord 2,0i CL7 | 2.0 | 114 | 10.02 - | K20A6 | 4 | 1,1 ZFR6K-11 | 6711 | | | |
| Accord 2,0i CB3..(MT/AT) | 2.0 | 98 | 01.90 - 10.98 | F20A4 | 4 | 1,1 ZFR6F-11 | 4291 | | LPG 6 | 1565 |
| Accord 2,0i CB3..(MT/AT) | 2.0 | 98 | 90 - | F20A8 | 4 | 1,1 ZFR6F-11 | 4291 | | LPG 6 | 1565 |
| Accord 2,0i 16V CA5 | 2.0 | 98 | 88 - | B20A8 Cat. | 4 | 1,1 BCPR6E-11 | 3132 | 11 | LPG 3 | 1498 |
| Accord 2,0i 16V EX CA-55500C..(MT) | 2.0 | 101 | 87 - | B20A2 | 4 | 1,1 BCPR6EY-N-11 | 6262 | | LPG 3 | 1498 |
| Accord 2,0i EX CA-55800C..(MT) | 2.0 | 85 | 87 - | A20A3 Cat. | 4 | 1,1 BPR6EY-11 | 4228 | 10 | LPG 2 | 1497 |
| Accord 2,0i EX CA-56800C..(AT) | 2.0 | 85 | 87 - | A20A3 Cat. | 4 | 1,1 BPR6EY-11 | 4228 | 10 | LPG 2 | 1497 |



ℓ kW

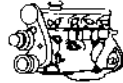

Cyl.

Order-
No.LPG/CNG
D-PowerOrder-
No.**HONDA**

| | | | | | | | | | | | | |
|----------------------------|-----------------|------|-----|--------------|-----------------|---|-----|-------------|------|----|-------------|------|
| Accord 2,0i LS | CE8.. | 2.0 | 96 | 95 - | | 4 | 1,1 | ZFR6F-11 | 4291 | | LPG 6 | 1565 |
| Accord 2,0i LS/ES | CE8 | 2.0 | 96 | 96 - | F20Z1 | 4 | 1,1 | ZFR6F-11 | 4291 | | LPG 6 | 1565 |
| Accord 2,0iLS / iES | CG9 | 2.0 | 108 | 99 -02.03 | F20B6 | 4 | 1,1 | ZFR6F-11 | 4291 | | LPG 6 | 1565 |
| Accord 2,2i (4WS) | CB7..(MT/AT) | 2.2 | 110 | 90 -05.03 | F22A3 | 4 | 1,1 | ZFR6F-11 | 4291 | | LPG 6 | 1565 |
| Accord 2,2i 16V | CE9.. | 2.2 | 110 | 95 -10.98 | | 4 | 1,1 | ZFR6F-11 | 4291 | | LPG 6 | 1565 |
| Accord 2,2i VTEC | CE9 | 2.2 | 110 | 95 -10.98 | F22Z2 | 4 | 1,1 | ZFR6F-11 | 4291 | | LPG 6 | 1565 |
| Accord 2,2iR | CH1 | 2.2 | 156 | 99 -02.03 | H22A7 | 4 | 1,1 | PZFR6F-11 | 3271 | | LPG 6 | 1565 |
| Accord 2,3 ES | CL3 | 2.3 | 113 | 01 -05.03 | F23Z5 | 4 | 1,1 | ZFR6F-11 | 4291 | | LPG 6 | 1565 |
| Accord 2,3 SR | CC7.. (MT) | 2.3 | 116 | 93 -05.03 | H23A3 | 4 | 1,1 | ZFR6F-11 | 4291 | | LPG 6 | 1565 |
| Accord 2,4i | CL9 | 2.4 | 140 | 02.03 - | K24A3 | 4 | 1,1 | IZFR6K11 | 6994 | | IZFR6K11 | 6994 |
| Accord 2.0 Sport | CL7 | 2.0 | 114 | 10.02 - | K20A6 | 4 | 1,1 | ZFR6K-11 | 6711 | | | |
| Accord 2.4 | (CU2) | 2.4 | 148 | 09 - | K24Z3 | 4 | 1,1 | ILZKR7B11GS | 7960 | | ILZKR7B11GS | 7960 |
| Accord 2.4 Sport | CL9 | 2.4 | 140 | 02.03 - | K24A3 | 4 | 1,1 | IZFR6K11 | 6994 | | IZFR6K11 | 6994 |
| Accord Aero 2,0 EX | CA-53300C..(MT) | 2.0 | 78 | 86 - | A20A2 | 4 | 1,1 | BPR6EY-11 | 4228 | 10 | LPG 2 | 1497 |
| Accord Aero 2,0 EX | CA-54300C..(AT) | 2.0 | 78 | 86 - | A20A2 | 4 | 1,1 | BPR6EY-11 | 4228 | 10 | LPG 2 | 1497 |
| Accord Aero 2,0 EX | CA-53700C..(MT) | 2.0 | 75 | 87 - | A20A1 Cat. 5MT | 4 | 1,1 | BPR6EY-11 | 4228 | 10 | LPG 2 | 1497 |
| Accord Aero 2,0 EX | CA-54700C..(AT) | 2.0 | 76 | 87 - | A20A1 Cat. 4AT | 4 | 1,1 | BPR6EY-11 | 4228 | 10 | LPG 2 | 1497 |
| Accord Aero 2,0 EXi | CA-53400C..(MT) | 2.0 | 90 | 86 - | A20A4 | 4 | 1,1 | BPR6EY-11 | 4228 | 10 | LPG 2 | 1497 |
| Accord Aero 2,0 EXi | CA-54400C..(AT) | 2.0 | 90 | 86 - | A20A4 | 4 | 1,1 | BPR6EY-11 | 4228 | 10 | LPG 2 | 1497 |
| Accord Aero 2,0i | CC9 | 2.0 | 98 | 93 - | F20Z3 | 4 | 1,1 | ZFR6F-11 | 4291 | | LPG 6 | 1565 |
| Accord Aero 2,0i EX | CA-53800C..(MT) | 2.0 | 85 | 87 - | A20A3 Cat. | 4 | 1,1 | BPR6EY-11 | 4228 | 10 | LPG 2 | 1497 |
| Accord Aero 2,0i EX | CA-54800C..(AT) | 2.0 | 85 | 87 - | A20A3 Cat. | 4 | 1,1 | BPR6EY-11 | 4228 | 10 | LPG 2 | 1497 |
| Accord Aero 2,0i LS,ES | CE2 (MT/AT) | 2.0 | 100 | 94 - | F20B3 | 4 | 1,1 | ZFR6F-11 | 4291 | | LPG 6 | 1565 |
| Accord Aero 2,2i | CB8 | 2.2 | 110 | 91 - 91 | F22A7-F22A8 | 4 | 1,1 | ZFR6F-11 | 4291 | | LPG 6 | 1565 |
| Accord Aero 2,2i LS,ES | CE1 (MT/AT) | 2.2 | 110 | 94 -10.98 | F22B5 | 4 | 1,1 | ZFR6F-11 | 4291 | | LPG 6 | 1565 |
| Accord Coupe 2,0 | CC1..(MT/AT) | 2.0 | 98 | 92 - | F20A7 | 4 | 1,1 | ZFR6F-11 | 4291 | | LPG 6 | 1565 |
| Accord Coupe 2,0i ES / iLS | (CG4) | 2.0 | 108 | 01.98 - | F20B5 | 4 | 1,1 | ZFR6F-11 | 4291 | | LPG 6 | 1565 |
| Accord Coupe 2,2i | CD7 (MT/AT) | 2.2 | 110 | 94 -10.98 | F22B5 | 4 | 1,1 | ZFR6F-11 | 4291 | | LPG 6 | 1565 |
| Accord Coupe 3,0i V6 | CG2 | 3.0 | 147 | 98 - | J30A1 | 6 | 1,1 | ZFR5F-11 | 2262 | | LPG 6 | 1565 |
| Accord TDi | | 2.0 | 77 | 05.95 -08.99 | Rover (L-Serie) | 4 | █ | Y-730U | 6704 | | D-POWER 17 | 6704 |
| Accord TDi | CF1 | 2.0 | 77 | 09.99 - | 20TN2 | 4 | █ | Y-730U | 6704 | | D-POWER 17 | 6704 |
| Accord Tourer | CM1 | 2.0 | 114 | 04.03 - | K20A6 | 4 | 1,1 | ZFR6K-11 | 6711 | | | |
| Accord Tourer | CM2 | 2.4 | 140 | 04.03 - | K24A3 | 4 | 1,1 | IZFR6K11 | 6994 | | IZFR6K11 | 6994 |
| Accord Tourer 2.4 | (CW2) | 2.4 | 148 | 09 - | K24Z3 | 4 | 1,1 | ILZKR7B11GS | 7960 | | ILZKR7B11GS | 7960 |
| Acty | | 0.55 | | - 82 | | 2 | 0,8 | BPR6ES | 7822 | 2 | LPG 2 | 1497 |
| Acty | | 0.55 | | 83 - 84 | | 2 | 0,8 | BPR5EY | 2828 | 9 | LPG 2 | 1497 |
| Acty | | 0.55 | | 84 - | | 2 | 0,8 | BPR6EY | 6427 | | LPG 2 | 1497 |
| Beat (PP1) 12V | | 0.66 | 47 | 91 - 98 | E07A (MTREC) | | 1,1 | BKR7E-11 | 1283 | | BKR8EIX | 2668 |
| Capa 16V | | 2.3 | 110 | 98 - | F23A7 | 4 | 1,1 | ZFR6F-11 | 4291 | | LPG 6 | 1565 |
| Civic | | 1.4 | | 01.97 - | PIJ (SOHC) | 4 | 1,1 | ZFR5F-11 | 2262 | | LPG 6 | 1565 |
| Civic | | 1.5 | | 97 - | VTi | 4 | 1,1 | BKR6EN-11 | 5724 | | | |
| Civic | | 1.6 | | 01.97 - | PIK(SOHC) | 4 | 1,1 | ZFR5F-11 | 2262 | | LPG 6 | 1565 |
| Civic EU8 | | 1.6 | 81 | 03.01 - | D16V1 | 4 | 1,1 | ZFR6J-11 | 5585 | | LPG 6 | 1565 |
| Civic EU7 | | 1.4 | 66 | 03.01 - | D14Z6 | 4 | 1,1 | ZFR6J-11 | 5585 | | LPG 6 | 1565 |
| Civic 5 Door | | 1.4 | | | PIH | 4 | 1,1 | BKR6E-11 | 2756 | 14 | LPG 1 | 1496 |
| Civic 5 Door | | 1.6 | | | PIJ DOHC | 4 | 1,1 | BKR6E-11 | 2756 | 14 | LPG 1 | 1496 |
| Civic 5 Door | | 1.6 | | | PIK DOHC | 4 | 1,1 | BKR6E-11 | 2756 | 14 | LPG 1 | 1496 |
| Civic 1.7 CTDi | EP4 | 1.7 | 74 | 02 - | 4EE2 | 4 | █ | Y-541J | 1983 | | D-POWER 42 | 1983 |
| Civic 1,2 | AL-4310S..(MT) | 1.2 | 40 | 84 - 87 | ZA2 | 4 | 1,1 | BPR6EY-11 | 4228 | 10 | LPG 2 | 1497 |
| Civic 1,3 | EC8..(MT/AT) | 1.3 | 55 | 88 -09.91 | D13B1 | 4 | 1,1 | BCPR6E-11 | 3132 | 11 | LPG 3 | 1498 |
| Civic 1,3 | EC8..(MT/AT) | 1.3 | 55 | 90 - 95 | D13B2 Cat. | 4 | 1,1 | BCPR6E-11 | 3132 | 11 | LPG 3 | 1498 |
| Civic 1,3 | EG3 | 1.3 | 55 | 92 - 95 | D13B2 | 4 | 1,1 | BKR6E-11 | 2756 | 14 | LPG 1 | 1496 |



ℓ kW



Cyl.

Order-
No. No.LPG/CNG
D-PowerOrder-
No.**HONDA**

| | | | | | | | | | | | |
|------------------------------------|-----|-----|----------|------------|---|-----|------------|------|----|------------|------|
| Civic 1,4 EC9/ED2..(AT/MT) | 1.4 | 66 | 88 - | D14A1 | 4 | 1,1 | BCPR6E-11 | 3132 | 11 | LPG 3 | 1498 |
| Civic 1,4 (FK1) | 1.4 | 61 | 06 - | L13A7 | 4 | 1,1 | IFR6G-11K | 1314 | | | |
| Civic 1,4 5Door EU7 | 1.4 | 66 | 01 - | D14Z6 SOHC | 4 | 1,1 | ZFR5J-11 | 5584 | | LPG 6 | 1565 |
| Civic 1,4 i 5Door MB2 | 1.4 | 55 | 97 - | D14A7 | 4 | 1,1 | ZFR5F-11 | 2262 | | LPG 6 | 1565 |
| Civic 1,4 iS 5Door MB2 | 1.4 | 66 | 97 - | D14A8 | 4 | 1,1 | ZFR5F-11 | 2262 | | LPG 6 | 1565 |
| Civic 1,4i (EJ9) | 1.4 | 55 | 96-02.01 | D14A3 | 4 | 1,1 | BKR6E-11 | 2756 | 14 | LPG 1 | 1496 |
| Civic 1,4i (EJ9) | 1.4 | 55 | 99-02.01 | D14Z1 | 4 | 1,1 | ZFR5J-11 | 5584 | | LPG 6 | 1565 |
| Civic 1,4i 5Door MA8 | 1.4 | 55 | 96 - | D14A5 | 4 | 1,1 | BKR6E-11 | 2756 | 14 | LPG 1 | 1496 |
| Civic 1,4i 5Door MB2 | 1.4 | 55 | 99 - | D14Z3 | 4 | 1,1 | ZFR5F-11 | 2262 | | LPG 6 | 1565 |
| Civic 1,4i 5Doorr MA8 (MT/AT) | 1.4 | 66 | 95 - | D14A2 | 4 | 1,1 | BKR6E-11 | 2756 | 14 | LPG 1 | 1496 |
| Civic 1,4iS (EJ9) | 1.4 | 66 | 96-02.01 | D14A4 | 4 | 1,1 | BKR6E-11 | 2756 | 14 | LPG 1 | 1496 |
| Civic 1,4iS EJ9 | 1.4 | 66 | 99-12.05 | D14Z2 | 4 | 1,1 | ZFR5J-11 | 5584 | | LPG 6 | 1565 |
| Civic 1,4iS 5Door MB2 | 1.4 | 66 | 99 - | D14Z4 | 4 | 1,1 | ZFR5F-11 | 2262 | | LPG 6 | 1565 |
| Civic 1,5 Vtec 5Door MB3 | 1.5 | 85 | 97 - | D15Z8 | 4 | 1,1 | ZFR5F-11 | 2262 | | LPG 6 | 1565 |
| Civic 1,5 VTEC-E 5Door MA9 | 1.5 | 66 | 95 - | D15Z3 | 4 | 1,1 | ZFR6F-11 | 4291 | | LPG 6 | 1565 |
| Civic 1,5DXI/LSi EG4/EG8 | 1.5 | 66 | 92 - | D15B2 | 4 | 1,1 | BKR6E-11 | 2756 | 14 | LPG 1 | 1496 |
| Civic 1,5i ED6/ED3 | 1.5 | 66 | 89-09.91 | D15B2 Cat. | 4 | 1,1 | BCPR6E-11 | 3132 | 11 | LPG 3 | 1498 |
| Civic 1,5iGT AH-5330S..(MT) | 1.5 | 66 | 86 - | EW4 Cat. | 4 | 1,1 | BPR6EY-11 | 4228 | 10 | LPG 2 | 1497 |
| Civic 1,5iGT AH-5330S..(MT) | 1.5 | 74 | 85 - | EW3 | 4 | 1,1 | BPR6EY-11 | 4228 | 10 | LPG 2 | 1497 |
| Civic 1,5iLS EK3 | 1.5 | 84 | 96 - | D15Z6 | 4 | 1,1 | ZFR6J-11 | 5585 | | LPG 6 | 1565 |
| Civic 1,5S AH-5330S..(MT) | 1.5 | 63 | 84 - | EW2 | 4 | 1,1 | BPR6EY-11 | 4228 | 10 | LPG 2 | 1497 |
| Civic 1,5VEI EG4 | 1.5 | 66 | 92 - | D15Z1 | 4 | 1,1 | ZFR6F-11 | 4291 | | LPG 6 | 1565 |
| Civic 1,6 ED4/ED7 | 1.6 | 80 | 88 - | D16A6 Cat. | 4 | 1,1 | BCPR6E-11 | 3132 | 11 | LPG 3 | 1498 |
| Civic 1,6 ED4/ED7 | 1.6 | 81 | 90- 01 | D16Z2 Cat. | 4 | 1,1 | BCPR6E-11 | 3132 | 11 | LPG 3 | 1498 |
| Civic 1,6 LS 5Door MB4 | 1.6 | 85 | 97 - | D16B2 | 4 | 1,1 | ZFR5F-11 | 2262 | | LPG 6 | 1565 |
| Civic 1,6 Vtec 5Door EU8 | 1.6 | 81 | 01 - | D16V1 SOHC | 4 | 1,1 | ZFR6J-11 | 5585 | | LPG 6 | 1565 |
| Civic 1,6ESI EG5/EG9 | 1.6 | 92 | 92 - | D16Z6 | 4 | 1,1 | BKR6E-11 | 2756 | 14 | LPG 1 | 1496 |
| Civic 1,6i ES EK1 | 1.6 | 84 | 96 - | D16Y5 | 4 | 1,1 | ZFR6J-11 | 5585 | | LPG 6 | 1565 |
| Civic 1,6i/LS 5Door MB4 | 1.6 | 85 | 99 - | D16W3 | 4 | 1,1 | ZFR5F-11 | 2262 | | LPG 6 | 1565 |
| Civic 1,6LS 5Door MB1 (MT/AT) | 1.6 | 83 | 95 - | D16Y3 | 4 | 1,1 | BKR6E-11 | 2756 | 14 | LPG 1 | 1496 |
| Civic 1,6SR VTEC 5Door MB1 (MT/AT) | 1.6 | 93 | 95 - | D16Y2 | 4 | 1,1 | BKR6E-11 | 2756 | 14 | LPG 1 | 1496 |
| Civic 1,6VTi EK4 | 1.6 | 118 | 96 - | B16A2 | 4 | 1,1 | BKR7EN-11 | 6256 | | | |
| Civic 1,6VTi EG6/EG9 | 1.6 | 118 | 92- 95 | B16A2 | 4 | 1,1 | BKR6E-11 | 2756 | 14 | LPG 1 | 1496 |
| Civic 1,8 FK2 | 1.8 | 103 | 06 - | R18A2 | 4 | 1,1 | IZFR6K-11S | 5266 | | | |
| Civic 1,8 VTI 5Door MB6 | 1.8 | 124 | 97 - | B18C4 | 4 | 1,1 | BKR6EN-11 | 5724 | | | |
| Civic 1.3 Hybrid (FD3) | 1.3 | 85 | 11.05 - | LDA | 4 | 1,1 | ILFR6J-11K | 4458 | | ILFR6J-11K | 4458 |
| Civic 1.3 IMA Hybrid (ES9) | 1.3 | 61 | 04 - | LDA1 | 4 | 1,1 | IFR5G-11K | 3107 | | IFR5G-11K | 3107 |
| Civic 1.3i IMA Hybrid (ES9) | 1.3 | 66 | 03 - | | 4 | 1,1 | IFR5G-11K | 3107 | | IFR5G-11K | 3107 |
| Civic 1.4i Aerodeck MB8 | 1.4 | 55 | 98 - | D14A7 | 4 | 1,1 | ZFR6F-11 | 4291 | | LPG 6 | 1565 |
| Civic 1.4iS Aerodeck MB8 | 1.4 | 66 | 98 - | D14A8 | 4 | 1,1 | ZFR6F-11 | 4291 | | LPG 6 | 1565 |
| Civic 1.5iVTEC Aerodeck MB9 | 1.5 | 85 | 98 - | D15Z8 | 4 | 1,1 | ZFR6F-11 | 4291 | | LPG 6 | 1565 |
| Civic 1.6iSR Aerodeck MC1 | 1.6 | 85 | 98 - | D16B2 | 4 | 1,1 | ZFR6F-11 | 4291 | | LPG 6 | 1565 |
| Civic 1.8 i-VTEC FD1 | 1.8 | 103 | 09.05 - | R18A | 4 | 1,1 | IZFR6K-11S | 5266 | | | |
| Civic 1.8iVTi Aerodeck M18C4 | 1.8 | 124 | 98 - | B18C4 | 4 | 1,1 | BKR7EN-11 | 6256 | | | |
| Civic 1300 AG-3320S..(AT) | 1.3 | 52 | 02.84 - | EV2 | 4 | 1,1 | BPR6EY-11 | 4228 | 10 | LPG 2 | 1497 |
| Civic 1300 AG-5320S..(MT) | 1.3 | 52 | 84 - | EV2 | 4 | 1,1 | BPR6EY-11 | 4228 | 10 | LPG 2 | 1497 |
| Civic 1300 SL-2320S..(2HM) | 1.3 | 44 | 80 - | EN1 | 4 | 0,9 | BPR5ES | 7422 | 6 | LPG 2 | 1497 |
| Civic 1300 SL-4310S..(4MT) | 1.3 | 33 | 80 - | EN2 | 4 | 0,9 | BPR5ES | 7422 | 6 | LPG 2 | 1497 |
| Civic 1300 SL-5320S..(5MT) | 1.3 | 44 | 80 - | EN1 | 4 | 0,9 | BPR5ES | 7422 | 6 | LPG 2 | 1497 |
| Civic 1300 SS-2520S..(2HM) | 1.3 | 44 | 80 - | EN1 | 4 | 0,9 | BPR5ES | 7422 | 6 | LPG 2 | 1497 |
| Civic 1300 SS-5520S..(5MT) | 1.3 | 44 | 80 - | EN1 | 4 | 0,9 | BPR5ES | 7422 | 6 | LPG 2 | 1497 |
| Civic 1300 WC-2520S..(2HM) | 1.3 | 44 | 80 - | EN1 | 4 | 0,9 | BPR5ES | 7422 | 6 | LPG 2 | 1497 |



ℓ kW

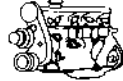

Cyl.

Order-
No. No.LPG/CNG
D-PowerOrder-
No.**HONDA**

| | | | | | | | | | | | |
|------------------------------|-----|-----|---------------|-------------------|---|-----|------------|------|----|------------|------|
| Civic 1300 WC-5520S..(5MT) | 1.3 | 44 | 80 - | EN1 | 4 | 0,9 | BPR5ES | 7422 | 6 | LPG 2 | 1497 |
| Civic 1300S SL-5330S..(5MT) | 1.3 | 51 | 82 - | EN4 | 4 | 0,8 | BPR6ES | 7822 | 2 | LPG 2 | 1497 |
| Civic 2.0i Sport (EV1) 5Door | 2.0 | 118 | 04 - | K20A3 | 4 | 1,1 | ZFR6K-11 | 6711 | | | |
| Civic Coupe 1,5i/LSi EJ2 | 1.5 | 74 | 94 - | D15B7 | 4 | 1,1 | ZFR6F-11 | 4291 | | LPG 6 | 1565 |
| Civic Coupe 1,6 Esi EJ1 | 1.6 | 92 | 94 - | D16Z9 | 4 | 1,1 | BKR6E-11 | 2756 | 14 | LPG 1 | 1496 |
| Civic Coupe 1,6 LS EJ6 | 1.6 | 77 | 96 - 98 | D16Y7 | 4 | 1,1 | BKR6E-11 | 2756 | 14 | LPG 1 | 1496 |
| Civic Coupe 1,6 LS EJ6 | 1.6 | 77 | 96 - 98 | D16Y7 | 4 | 1,1 | BKR6E-11 | 2756 | 14 | LPG 1 | 1496 |
| Civic Coupe 1,6 SR EJ8 | 1.6 | 92 | 99 - | D16Y8 | 4 | 1,1 | ZFR5F-11 | 2262 | | LPG 6 | 1565 |
| Civic Coupe 1,6i SR EJ8 | 1.6 | 92 | 96 - 98 | D16Y8 | 4 | 1,1 | BKR6E-11 | 2756 | 14 | LPG 1 | 1496 |
| Civic Coupe 1,6i SR EJ8 | 1.6 | 92 | 96 - | D16Y8 | 4 | 1,1 | BKR6E-11 | 2756 | 14 | LPG 1 | 1496 |
| Civic Coupe 1,6iLS EJ6 | 1.6 | 77 | 99 - | D16Y7 | 4 | 1,1 | ZFR5F-11 | 2262 | | LPG 6 | 1565 |
| Civic Coupe 1,7 ES EM2 | 1.7 | 92 | 01 - | D17A9 | 4 | 1,1 | ZFR6J-11 | 5585 | | LPG 6 | 1565 |
| Civic Coupe 1,7 LS EM2 | 1.7 | 88 | 01 - | D17A8 | 4 | 1,1 | ZFR6J-11 | 5585 | | LPG 6 | 1565 |
| Civic GL AH-3320S..(AT) | 1.5 | 63 | 85 - | EW2 | 4 | 1,1 | BPR6EY-11 | 4228 | 10 | LPG 2 | 1497 |
| Civic GL AH-5320S..(MT) | 1.5 | 63 | 85 - | EW2 | 4 | 1,1 | BPR6EY-11 | 4228 | 10 | LPG 2 | 1497 |
| Civic P9L(VTEC) | 1.5 | | 01.97 - 02.01 | D15Z8 | 4 | 1,1 | ZFR5F-11 | 2262 | | LPG 6 | 1565 |
| Civic Shuttle 1,6i EE | 1.6 | 80 | 88 - | D16A6 Cat. | 4 | 1,1 | BCPR6E-11 | 3132 | 11 | LPG 3 | 1498 |
| Civic Shuttle 1,6i EE | 1.6 | 81 | 88 - | D16Z2 Cat. | 4 | 1,1 | BCPR6E-11 | 3132 | 11 | LPG 3 | 1498 |
| Civic Type R FN2 | 2.0 | 148 | 07 - | K20ZA | 4 | 1,1 | IFR7G-11KS | 7746 | | IFR7G-11KS | 7746 |
| Civic Type R EK9 | 1.6 | 148 | - 12.01 | B16B | 4 | 1,1 | PFR7G-11S | 7772 | | | |
| Civic Type-R EP3 | 2.0 | 147 | 08.01 - 06 | K20A2 | 4 | 1,1 | IFR7G-11KS | 7746 | | IFR7G-11KS | 7746 |
| Civic VTEC EE9 | 1.6 | 110 | 90 - | B16A1 | 4 | 1,1 | BKR6EN-11 | 5724 | | | |
| Concerto 1,5i HW..(MT/AT) | 1.5 | 66 | 90 - 95 | D15B2 Cat. | 4 | 1,1 | BCPR6E-11 | 3132 | 11 | LPG 3 | 1498 |
| Concerto 1,6-16V HW | 1.6 | 90 | 90 - 95 | D16A8 DOHC | 4 | 1,1 | BCPR6E-11 | 3132 | 11 | LPG 3 | 1498 |
| Concerto 1,6i HW..(MT/AT) | 1.6 | 82 | 90 - 95 | D16Z2 SOHC Cat. | 4 | 1,1 | BCPR6E-11 | 3132 | 11 | LPG 3 | 1498 |
| Concerto TD | 1.8 | 64 | 10.94 - 12.95 | XUD 7 TE | 4 | █ | Y-924J | 7906 | | D-POWER 1 | 7906 |
| CR-V RD1 | 2.0 | 94 | 05.97 - | B20B3 | 4 | 1,1 | ZFR5F-11 | 2262 | | LPG 6 | 1565 |
| CR-V RD1 | 2.0 | 108 | 03.99 - | B20Z1 | 4 | 1,1 | ZFR6F-11 | 4291 | | LPG 6 | 1565 |
| CR-V RD8 | 2.0 | 110 | 02 - | K20A4 | 4 | 1,1 | ZFR6K-11 | 6711 | | | |
| CR-V RE5 | 2.0 | 110 | 07 - | R20A2 | 4 | 1,1 | IZFR6K-11S | 5266 | | | |
| CRX AF-5320S..(MT) | 1.5 | 74 | 84 - | EW3 | 4 | 1,1 | BPR6EY-11 | 4228 | 10 | LPG 2 | 1497 |
| CRX 1,6 EG2 | 1.6 | 118 | 92 - | B16A2 | 4 | 1,1 | BKR6EN-11 | 5724 | | | |
| CRX 1,6 EH6..(MT/AT) | 1.6 | 92 | 92 - | D16Z6 | 4 | 1,1 | BKR6E-11 | 2756 | 14 | LPG 1 | 1496 |
| CRX 1,6i-16 ED9 | 1.6 | 91 | 89 - | D16Z5 Cat. | 4 | 1,1 | BCPR6E-11 | 3132 | 11 | LPG 3 | 1498 |
| CRX 1,6i-16 ED9 | 1.6 | 96 | 88 - | D16A9 | 4 | 1,1 | BCPR6E-11 | 3132 | 11 | LPG 3 | 1498 |
| CRX 16V AS-5330S..(MT) | 1.6 | 92 | 01.86 - | ZC1 | 4 | 1,1 | BCPR6EY-11 | 3720 | | LPG 3 | 1498 |
| CRX VTEC EE8 | 1.6 | 110 | 90 - | B16A1 | 4 | 1,1 | BKR6EN-11 | 5724 | | | |
| FR-V BE1 | 1.7 | 92 | 01.05 - | D17A2 SOHC VTEC | 4 | 1,1 | ZFR6J-11 | 5585 | | LPG 6 | 1565 |
| FR-V BE3 | 2.0 | 110 | 01.05 - | K20A9 DOHC i-VTEC | 4 | 1,1 | ZFR6K-11 | 6711 | | | |
| HR-V GH2 | 1.6 | 77 | 02.99 - | D16W1 | 4 | 1,1 | ZFR5J-11 | 5584 | | LPG 6 | 1565 |
| HR-V 1.6 VTEC GH2 | 1.6 | 91 | 10.99 - | VTEC | 4 | 1,1 | ZFR5J-11 | 5584 | | LPG 6 | 1565 |
| Integra | 1.6 | 88 | 03.86 - 08.89 | D16A3 | 4 | 1,1 | BCPR6E-11 | 3132 | 11 | LPG 3 | 1498 |
| Integra R DC2 | 1.8 | 140 | 99 - 01 | B18C6 | 4 | 1,1 | PFR7G-11 | 2380 | | PFR7G | 4364 |
| Integra R DC2 | 1.8 | 140 | 10.97 - 99 | B18C6 | 4 | 1,1 | PFR7G-11 | 2380 | | PFR7G | 4364 |
| Integra Type-R 16V | 2.0 | 162 | 02.02 - | K20A | 4 | 1,1 | IFR7G-11KS | 7746 | | IFR7G-11KS | 7746 |
| Jazz 1,2 (GD5) | 1.2 | 57 | 03 - | L12A1 TwinSpark | 4 | 1,1 | BKR6E-11 | 2756 | 14 | LPG 1 | 1496 |
| Jazz 1,2 (GE2) CHAC | 1.2 | 57 | 06 - | L12A4 | 4 | 1,1 | BKR6E-11 | 2756 | 14 | LPG 1 | 1496 |
| Jazz 1,2 i-DSI | 1.2 | 57 | 02 - | TwinSpark | 4 | 1,1 | BKR6E-11 | 2756 | 14 | LPG 1 | 1496 |
| Jazz 1,3 (GE3) CHAC | 1.3 | 61 | 06 - | L13A6 | 4 | 1,1 | BKR6E-11 | 2756 | 14 | LPG 1 | 1496 |
| Jazz 1,4 (GD1) | 1.4 | 61 | 02 - | L13A1TwinSpark | 4 | 1,1 | BKR6E-11 | 2756 | 14 | LPG 1 | 1496 |
| Jazz 1,4 (GE3) CHAC | 1.4 | 61 | 06 - | L13A6 | 4 | 1,1 | BKR6E-11 | 2756 | 14 | LPG 1 | 1496 |
| Jazz 45 AA-4310S..(4MT) | 1.2 | 33 | 84 - | ER2 | 4 | 1,1 | BPR5EY-11 | 3028 | | LPG 2 | 1497 |



ℓ kW

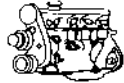

Cyl.



Order-
No. No.



LPG/CNG
D-Power

Order-
No.

HONDA

| | | | | | | | | | | | |
|----------------------------------|-----|-----|-------------|--------------|---|-----|--------------|------|----|----------|------|
| Jazz 55 AA-3320S.. (3HMT) | 1.2 | 40 | 85 - | ER4 | 4 | 1,1 | BPR5EY-11 | 3028 | | LPG 2 | 1497 |
| Jazz 56 AA-5320S.. (5MT) | 1.2 | 41 | 84 - | ER1 | 4 | 1,1 | BPR5EY-11 | 3028 | | LPG 2 | 1497 |
| Legend 2,7i HS/KA4 | 2.7 | 124 | 88-02.91 | C27A1 Cat. | 6 | 1,1 | BCPR6E-11 | 3132 | 11 | LPG 3 | 1498 |
| Legend 3,2 KA7/KA8 | 3.2 | 151 | 91 - 96 | C32A2 | 6 | 1,1 | PFR6G-11 | 5555 | | PFR7G | 4364 |
| Legend 3,2 KA7/KA8 | 3.2 | 151 | 93- 96 | C32A2 | 6 | 1,1 | PFR6G-11 | 5555 | | PFR7G | 4364 |
| Legend 3,5 V6 | 3.5 | 151 | 95- 04 | C35A2 | 6 | 1,1 | PFR6G-11 | 5555 | | PFR7G | 4364 |
| Legend 3,5 V6 KA9 | 3.5 | 151 | 96- 04 | C35A5 | 6 | 1,1 | PFR6G-11 | 5555 | | PFR7G | 4364 |
| Legend 3,5 V6 KB1 | 3.5 | 217 | 07 - | J35A8 | 6 | 1,1 | IZFR6K11 | 6994 | | IZFR6K11 | 6994 |
| Legend 3.5 SH-AWD KB1 | 3.5 | 217 | 06 - | J35A8 | 6 | 1,1 | IZFR6K11 | 6994 | | IZFR6K11 | 6994 |
| Legend Coupe 2,7i KA3 | 2.7 | 124 | 88 - | C27A1 Cat. | 6 | 1,1 | BCPR6EY-N-11 | 6262 | | LPG 3 | 1498 |
| Legend V6 2,5i HS..N..(MT) | 2.5 | 110 | 87 - | C25A1 Cat. | 6 | 1,1 | BCPR6E-11 | 3132 | 11 | LPG 3 | 1498 |
| Legend V6 2,5i HS..N..(MT) | 2.5 | 127 | 87 - | C25A1 | 6 | 1,1 | BCPR6E-11 | 3132 | 11 | LPG 3 | 1498 |
| Legend V6 2,5i HS..Y..(AT) | 2.5 | 110 | 87 - | C25A1 Cat. | 6 | 1,1 | BCPR6E-11 | 3132 | 11 | LPG 3 | 1498 |
| Legend V6 2,5i HS..Y..(AT) | 2.5 | 127 | 87 - | C25A1 | 6 | 1,1 | BCPR6E-11 | 3132 | 11 | LPG 3 | 1498 |
| Logo 1,3 i | 1.3 | 48 | 99- 01 | D13B7 | 4 | 1,1 | ZFR5J-11 | 5584 | | LPG 6 | 1565 |
| MDX (UA-YD1) | 3.5 | 191 | 03 - | J35A VTEC | 6 | 1,1 | IZFR6K11 | 6994 | | IZFR6K11 | 6994 |
| NSX NA1 | 3.0 | 188 | 91-01.05 | C30A3/C30A4 | 6 | 1,1 | PFR6G-11 | 5555 | | PFR7G | 4364 |
| NSX NA2 | 3.2 | 206 | 01.97-09.05 | C32B2 | 6 | 1,1 | PFR6G-11 | 5555 | | PFR7G | 4364 |
| Prelude 1,6 SN-3220C..(3HM) | 1.6 | 59 | 80- 80 | EL | 4 | 0,8 | BPR6ES | 7822 | 2 | LPG 2 | 1497 |
| Prelude 1,6 SN-3220C1..(3HM) | 1.6 | 59 | 81- 81 | EL | 4 | 0,8 | BPR6ES | 7822 | 2 | LPG 2 | 1497 |
| Prelude 1,6 SN-5220C..(5MT) | 1.6 | 59 | 80- 80 | EL | 4 | 0,8 | BPR6ES | 7822 | 2 | LPG 2 | 1497 |
| Prelude 1,6 SN-5220C1..(5MT) | 1.6 | 59 | 81- 81 | EL | 4 | 0,8 | BPR6ES | 7822 | 2 | LPG 2 | 1497 |
| Prelude 1,8 AB-5220C..(MT) | 1.8 | 77 | 83- 92 | ET | 4 | 0,8 | BPR6EY | 6427 | | LPG 2 | 1497 |
| Prelude 1,8 AB-5230C..(MT) | 1.8 | 77 | 83- 92 | ET | 4 | 0,8 | BPR6EY | 6427 | | LPG 2 | 1497 |
| Prelude 1,8 AB-5240C..(MT) | 1.8 | 74 | 85- 92 | ET2 | 4 | 1,1 | BPR6EY-11 | 4228 | 10 | LPG 2 | 1497 |
| Prelude 1,8 AB-7230C..(AT) | 1.8 | 74 | 83- 92 | ET | 4 | 0,8 | BPR6EY | 6427 | | LPG 2 | 1497 |
| Prelude 2,0 | 2.0 | 98 | 97-12.99 | | 4 | 1,1 | ZFR6F-11 | 4291 | | LPG 6 | 1565 |
| Prelude 2,0 BB3..(MT/AT) | 2.0 | 98 | 92-12.99 | F20A4 | 4 | 1,1 | ZFR6F-11 | 4291 | | LPG 6 | 1565 |
| Prelude 2,0 BA4.. | 2.0 | 84 | 88-01.92 | B20A4 | 4 | 1,1 | BCPR6EY-N-11 | 6262 | | LPG 3 | 1498 |
| Prelude 2,0 BA4..(MT/AT) | 2.0 | 80 | 88-01.92 | B20A3 Cat. | 4 | 1,1 | BCPR6EY-N-11 | 6262 | | LPG 3 | 1498 |
| Prelude 2,0 BA4..(MT/AT) | 2.0 | 80 | 90-01.92 | B20A3 Cat. | 4 | 1,1 | BCPR6EY-N-11 | 6262 | | LPG 3 | 1498 |
| Prelude 2,0 16V 4WS)BA4 | 2.0 | 103 | 90-01.92 | B20A9 Cat. | 4 | 1,1 | BCPR6EY-N-11 | 6262 | | LPG 3 | 1498 |
| Prelude 2,0 16V 4WS)BA4 | 2.0 | 101 | 88-01.92 | B20A5 Cat. | 4 | 1,1 | BCPR6EY-N-11 | 6262 | | LPG 3 | 1498 |
| Prelude 2,0 i (BB9) | 2.0 | 98 | 99-12.99 | F20A4 | 4 | 1,1 | ZFR6F-11 | 4291 | | LPG 6 | 1565 |
| Prelude 2,0i 16V BA2-1300C..(MT) | 2.0 | 101 | 86- 92 | BA20A1 DOHC | 4 | 1,1 | BCPR6E-11 | 3132 | 11 | LPG 3 | 1498 |
| Prelude 2,2 VTEC BB1..(MT) | 2.2 | 136 | 93-09.96 | H22A2 | 4 | 1,1 | PZFR6F-11 | 3271 | | LPG 6 | 1565 |
| Prelude 2,2 Vti (BB6/BB8) | 2.2 | 136 | 99-12.01 | H22A5 | 4 | 1,1 | PZFR6F-11 | 3271 | | LPG 6 | 1565 |
| Prelude 2,2i | 2.2 | 136 | 97-12.01 | H22A5 | 4 | 1,1 | PZFR6F-11 | 3271 | | LPG 6 | 1565 |
| Prelude 2,3 BB2..(MT/AT) | 2.3 | 118 | 92-09.96 | H23A2 | 4 | 1,1 | ZFR6F-11 | 4291 | | LPG 6 | 1565 |
| Quintet JHMA SU3..(3HM) | 1.6 | 59 | 81- 81 | EL | 4 | 0,8 | BPR6ES | 7822 | 2 | LPG 2 | 1497 |
| Quintet JHMA SU5..(5MT) | 1.6 | 59 | 81- 81 | EL | 4 | 0,8 | BPR6ES | 7822 | 2 | LPG 2 | 1497 |
| S 2000 (AP1) | 2.0 | 177 | 06.00 - | F20C2 | 4 | 1,1 | PFR7G-11S | 7772 | | | |
| Shuttle AN-3520S..(AT) | 1.5 | 63 | 84 - | EW2 | 4 | 1,1 | BPR6EY-11 | 4228 | 10 | LPG 2 | 1497 |
| Shuttle AN-5520S..(MT) | 1.5 | 63 | 84 - | EW2 | 4 | 1,1 | BPR6EY-11 | 4228 | 10 | LPG 2 | 1497 |
| Shuttle 2,2i ES | 2.2 | 110 | 95-12.97 | F22 RA1 (AT) | 4 | 1,1 | ZFR6F-11 | 4291 | | LPG 6 | 1565 |
| Shuttle 2,3 RA3 | 2.3 | 110 | 98-05.01 | F23A7 | 4 | 1,1 | ZFR6F-11 | 4291 | | LPG 6 | 1565 |
| Shuttle 4WD AR-6520C..(MT) | 1.5 | 63 | 85 - | EW2 | 4 | 1,1 | BPR6EY-11 | 4228 | 10 | LPG 2 | 1497 |
| Stream (RN1) | 1.7 | 92 | 04.01 - | D17A2 | 4 | 1,1 | ZFR6J-11 | 5585 | | LPG 6 | 1565 |
| Stream (RN3) | 2.0 | 115 | 04.01 - | K20A1 | 4 | 1,1 | ZFR6K-11 | 6711 | | | |



ℓ kW

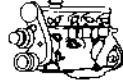

Cyl.

Order-
No.LPG/CNG
D-PowerOrder-
No.**HUMMER-AM GENERAL**

| | | | | | | | | | | | |
|------------|-----|-----|---------|----------|---|-----|-----------|------|----|-----------|------|
| Hummer | 5.7 | | 94 - 96 | D EFI V8 | 8 | 1,3 | UR5 | 2139 | | UR6IX | 7348 |
| Hummer | 8.1 | | 03 - | G EFI V8 | 8 | 1,5 | PZTR5A-15 | 7862 | | PZTR5A-15 | 7862 |
| Hummer H 2 | 6.0 | | 03 - 06 | N EFI V8 | 8 | 1,0 | TR5 | 2238 | | | |
| Hummer H 3 | 3.4 | 162 | 05 - | | 5 | 1,3 | PTR5A-13 | 2467 | 25 | LPG 4 | 1511 |

HYUNDAI

| | | | | | | | | | | | |
|---------------------------------|-----|-----|---------------|---------------|---|-----|-----------|------|----|------------|------|
| Accent | 1.3 | 44 | 10.94 - 99 | G4EH | 4 | 1,1 | BKR5ES-11 | 2382 | 33 | LPG 1 | 1496 |
| Accent | 1.3 | 55 | 10.94 - 99 | G4EH | 4 | 1,1 | BKR5ES-11 | 2382 | 33 | LPG 1 | 1496 |
| Accent | 1.5 | 65 | 10.94 - 07.99 | G4EK | 4 | 1,1 | BKR5ES-11 | 2382 | 33 | LPG 1 | 1496 |
| Accent 12V CRDi | 1.5 | 60 | 04.02 - | D3EA | 3 | █ | Y-749J | 5013 | | | |
| Accent GT 16V | 1.5 | | 95 - 07.99 | G4EK | 4 | 1,1 | BKR5ES-11 | 2382 | 33 | LPG 1 | 1496 |
| Accent TDI | 1.5 | 55 | 04.02 - | | 3 | █ | Y-749J | 5013 | | | |
| Accent 1.4 | 1.4 | 71 | 06.06 - | G4EE | 4 | 1,1 | BKR5ES-11 | 2382 | 33 | LPG 1 | 1496 |
| Accent 1.6 (MC) | 1.6 | 82 | 06.06 - | G4ED | 4 | 1,1 | BKR5ES-11 | 2382 | 33 | LPG 1 | 1496 |
| Accent/LC | 1.3 | 55 | 99 - 03.06 | G4EA | 4 | 1,1 | BKR5ES-11 | 2382 | 33 | LPG 1 | 1496 |
| Accent/LC | 1.3 | 64 | 99 - 03.06 | G4EA | 4 | 1,1 | BKR5ES-11 | 2382 | 33 | LPG 1 | 1496 |
| Accent/LC | 1.5 | 66 | 01.00 - 06 | G4EB | 4 | 1,1 | BKR5ES-11 | 2382 | 33 | LPG 1 | 1496 |
| Accent/LC 16V | 1.5 | 75 | 99 - 06 | G4EA | 4 | 1,1 | BKR5ES-11 | 2382 | 33 | LPG 1 | 1496 |
| Amica | 1.0 | | 00 - | | 4 | 1,1 | BKR5E-11 | 6953 | 33 | LPG 1 | 1496 |
| Atos | 0.8 | | - 02 | LPG | 4 | 0,8 | BKR6ES | 3783 | 28 | LPG 1 | 1496 |
| Atos | 1.1 | 46 | 03.04 - | | 4 | 1,1 | BKR5ES-11 | 2382 | 33 | LPG 1 | 1496 |
| Atos / MX | 1.0 | 40 | 99 - 02 | G4HC | 4 | 1,1 | BKR5ES-11 | 2382 | 33 | LPG 1 | 1496 |
| Atos Prime | 1.0 | 40 | 99 - 02 | G4HC | 4 | 1,1 | BKR5ES-11 | 2382 | 33 | LPG 1 | 1496 |
| Avante | 1.5 | | | DOHC | 4 | 1,1 | BKR5ES-11 | 2382 | 33 | LPG 1 | 1496 |
| Avante | 1.6 | | | DOHC | 4 | 1,1 | BKR5ES-11 | 2382 | 33 | LPG 1 | 1496 |
| Avante | 1.8 | | | DOHC | 4 | 1,1 | BKR5ES-11 | 2382 | 33 | LPG 1 | 1496 |
| Avante | 2.0 | | | DOHC | 4 | 1,1 | BKR5ES-11 | 2382 | 33 | LPG 1 | 1496 |
| Coupe | 2.0 | 102 | 03.96 - 09.01 | G4GF DOHC | 4 | 1,1 | BKR5ES-11 | 2382 | 33 | LPG 1 | 1496 |
| Coupe (GK) | 2.0 | 105 | 03.02 - | G4GC-G | 4 | 1,1 | BKR5ES-11 | 2382 | 33 | LPG 1 | 1496 |
| Coupe (GK) | 2.7 | 121 | 03.02 - | G6BA-G V6 | 6 | 1,1 | PFR5J-11 | 4642 | | PFR5J-11 | 4642 |
| Coupe (RD) | 1.6 | 84 | 12.96 - 04.02 | 4G61 | 4 | 1,1 | BKR5ES-11 | 2382 | 33 | LPG 1 | 1496 |
| Coupe 2.0 | 2.0 | 99 | 01 - | G4GF-EG | 4 | 1,1 | BKR5ES-11 | 2382 | 33 | LPG 1 | 1496 |
| Coupe 2.0 | 2.0 | 102 | 99 - | G4GC | 4 | 1,1 | BPR5ES-11 | 4424 | | LPG 2 | 1497 |
| Dynasty 2.5 V6 | 2.5 | | | | 6 | 1,1 | PFR6N-11 | 3546 | | LPG 1 | 1496 |
| Dynasty 3.0 V6 | 3.0 | | | | 6 | 1,1 | PFR6N-11 | 3546 | | LPG 1 | 1496 |
| Dynasty 3.5 V6 | 3.5 | | | | 6 | 1,1 | PFR6N-11 | 3546 | | LPG 1 | 1496 |
| Elantra | 1.5 | | - 02.95 | DOHC | 4 | 1,1 | BPR6ES-11 | 4824 | 13 | LPG 2 | 1497 |
| Elantra | 1.5 | | 03.95 - 06.05 | | 4 | 1,1 | BKR5E-11 | 6953 | 33 | LPG 1 | 1496 |
| Elantra | 1.6 | | - 99 | DOHC | 4 | 1,1 | BPR6ES-11 | 4824 | 13 | LPG 2 | 1497 |
| Elantra | 1.8 | | | DOHC | 4 | 1,1 | BPR6ES-11 | 4824 | 13 | LPG 2 | 1497 |
| Elantra | 2.0 | 105 | 03 - | | 4 | 1,1 | BKR5E-11 | 6953 | 33 | LPG 1 | 1496 |
| Elantra CRDi | 2.0 | 83 | 01 - | D4EA | 4 | █ | Y-749J | 5013 | | | |
| Elantra / XD | 1.6 | 79 | 00 - | G4ED-G DOHC | 4 | 1,1 | BKR5ES-11 | 2382 | 33 | LPG 1 | 1496 |
| Elantra / XD | 2.0 | 102 | 00 - | G4GC-G DOHC | 4 | 1,1 | BKR5ES-11 | 2382 | 33 | LPG 1 | 1496 |
| Exel | 1.3 | 62 | 96 - 07.99 | G4EK | 4 | 1,1 | BKR6E-11 | 2756 | 14 | LPG 1 | 1496 |
| FC | 1.6 | 76 | 07.01 - | | 4 | 1,1 | BKR5ES-11 | 2382 | 33 | LPG 1 | 1496 |
| Galopper | 2.5 | 57 | - 01.94 | 4D55 | 4 | █ | Y-115T1 | 2189 | | | |
| Galopper | 3.0 | 104 | 08.98 - 08.01 | G6AT Unleaded | 6 | 1,1 | BPR5ES-11 | 4424 | | LPG 2 | 1497 |
| Galopper | 3.0 | 104 | 08.98 - | Leaded+LPG | 6 | 0,9 | BPR5ES | 7422 | 6 | LPG 2 | 1497 |
| Galopper | 3.0 | | 98 - 08.01 | G6AT SOHC V6 | 6 | 1,1 | BKR5ES-11 | 2382 | 33 | LPG 1 | 1496 |
| Galopper TC,TCI | 2.5 | 65 | 11.95 - | 4D56 | 4 | █ | CY57 | 4994 | | D-POWER 21 | 4994 |
| Galopper TD 3/5p GLS, Inovation | 2.5 | 74 | 01.99 - | | 4 | █ | CY57* | 4994 | | D-POWER 21 | 4994 |



ℓ kW



Cyl.

Order-
No. No.LPG/CNG
D-PowerOrder-
No.**HYUNDAI**

| | | | | | | | | | | | |
|----------------------|-----|-----|---------------|----------------|---|-----|-----------|------|----|------------|------|
| Getz (TB) | 1.1 | 46 | 09.02 - 08 | G4HD | 4 | 1,1 | BKR5ES-11 | 2382 | 33 | LPG 1 | 1496 |
| Getz (TB) | 1.3 | 60 | 09.02 - 08 | G4EA | 4 | 1,1 | BKR5ES-11 | 2382 | 33 | LPG 1 | 1496 |
| Getz (TB) | 1.4 | 71 | 05 - 08 | G4EE | 4 | 1,1 | BKR5ES-11 | 2382 | 33 | LPG 1 | 1496 |
| Getz (TB) | 1.6 | 78 | 09.02 - | G4ED | 4 | 1,1 | BKR5ES-11 | 2382 | 33 | LPG 1 | 1496 |
| Getz D | 1.5 | 60 | 07.03 - 08 | D3EA | 3 | █ | Y-749J | 5013 | | | |
| Grace H100 | 2.5 | | | 4D55 | 4 | █ | Y-115T1 | 2189 | | | |
| Grace 2.4 | 2.4 | 82 | | SOHC | 4 | 1,1 | BPR6ES-11 | 4824 | 13 | LPG 2 | 1497 |
| Grandeur 3.3 V6 (TG) | 3.3 | 173 | 08.05 - | G6DB | 6 | 1,1 | IFR5G11 | 7854 | | | |
| H 1 | 2.4 | 85 | 09.97 - | H100 | 4 | 1,1 | BPR6ES-11 | 4824 | 13 | LPG 2 | 1497 |
| H 1 Starex | 2.4 | 82 | 98 - | G4CS | 4 | 1,1 | BPR6ES-11 | 4824 | 13 | LPG 2 | 1497 |
| H 1 Starex TD | 2.5 | 59 | 10.97 - | D4BF | 4 | █ | Y-722JS | 9974 | | | |
| H 1 TD | 2.5 | 59 | 03.00 - 09.00 | D4BF | 4 | █ | Y-722JS | 9974 | | | |
| H 1 TD | 2.5 | 73 | 03.00 - | D4BH | 4 | █ | Y-722JS | 9974 | | | |
| H 100 D | 2.5 | 57 | - 96 | 4D56 | 4 | █ | CY57 | 4994 | | D-POWER 21 | 4994 |
| H 100 D | 2.5 | 57 | - 96 | D4BA 4D55 | 4 | █ | Y-115T1 | 2189 | | | |
| H 100 D intercooler | 2.5 | 63 | 07.93 - 03.00 | D4BF | 4 | █ | Y-722JS | 9974 | | | |
| H 100 i | 2.4 | 84 | 01.97 - | | 4 | 1,1 | BP6EY-11 | 4128 | | | |
| i10 1.1 (PA) | 1.1 | 49 | 08 - | G4HG | 4 | 1,1 | BKR5ES-11 | 2382 | 33 | LPG 1 | 1496 |
| i10 1.2 (PA) | 1.2 | 57 | 08 - | G4LA | 4 | 0,8 | PLKR7A | 4288 | | PLKR7A | 4288 |
| i20 1.2 (PB) | 1.2 | 57 | 01.09 - | G4LA | 4 | 0,8 | PLKR7A | 4288 | | PLKR7A | 4288 |
| i20 1.4 (PB) | 1.4 | 74 | 01.09 - | G4FA | 4 | 1,1 | ZFR5F-11 | 2262 | | LPG 6 | 1565 |
| i30 1.4 (FD) | 1.4 | 80 | 08.07 - | G4FA | 4 | 1,1 | ZFR5F-11 | 2262 | | LPG 6 | 1565 |
| i30 1.6 (FD) | 1.6 | 93 | 01.07 - | G4FC | 4 | 1,1 | ZFR5F-11 | 2262 | | LPG 6 | 1565 |
| i30 2.0 (FD) | 2.0 | 105 | 07.07 - | G4GC | 4 | 1,1 | BKR5ES-11 | 2382 | 33 | LPG 1 | 1496 |
| Lantra 1(J-1) | 1.5 | 63 | 92 - 04.95 | G4DJ | 4 | 1,1 | BPR6ES-11 | 4824 | 13 | LPG 2 | 1497 |
| Lantra 1(J-1) | 1.6 | 78 | 92 - 04.95 | G4CR | 4 | 1,1 | BPR6ES-11 | 4824 | 13 | LPG 2 | 1497 |
| Lantra 1(J-1) | 1.8 | 93 | 92 - 04.95 | G4CN | 4 | 1,1 | BPR6ES-11 | 4824 | 13 | LPG 2 | 1497 |
| Lantra 2(J-2) | 1.6 | 66 | 09.95 - 09.00 | G4GR | 4 | 1,1 | BKR5ES-11 | 2382 | 33 | LPG 1 | 1496 |
| Lantra 2(J-2) | 1.6 | 84 | 09.95 - 09.00 | G4GR | 4 | 1,1 | BKR5ES-11 | 2382 | 33 | LPG 1 | 1496 |
| Lantra 2(J-2) | 1.8 | 94 | 09.95 - 09.00 | G4GM | 4 | 1,1 | BKR5ES-11 | 2382 | 33 | LPG 1 | 1496 |
| Lantra 2(J-2) | 2.0 | 102 | 02.97 - 00 | | 4 | 1,1 | BKR5ES-11 | 2382 | 33 | LPG 1 | 1496 |
| Lantra 3 | 1.6 | 79 | 09.00 - | G4ED-G DOHC | 4 | 1,1 | BKR5ES-11 | 2382 | 33 | LPG 1 | 1496 |
| Lantra 3 | 2.0 | 101 | 09.00 - | G4GC-G DOHC | 4 | 1,1 | BKR5ES-11 | 2382 | 33 | LPG 1 | 1496 |
| Lantra D | 1.9 | 50 | 98 - | XUD9A | 4 | █ | Y-938R | 5267 | | D-POWER 1 | 7906 |
| LC 1.3i | 1.3 | 55 | 01 - | G4EA-G | 4 | 1,1 | BKR5ES-11 | 2382 | 33 | LPG 1 | 1496 |
| LC 1.5i | 1.5 | 75 | 01 - | G4EC-G DOHC | 4 | 1,1 | BKR5ES-11 | 2382 | 33 | LPG 1 | 1496 |
| M.X. | 1.0 | 43 | 05.98 - | | 4 | 1,1 | BKR6ES-11 | 5553 | 14 | LPG 1 | 1496 |
| Matrix | 1.8 | 90 | 08.01 - | G4GB | 4 | 1,1 | BKR5ES-11 | 2382 | 33 | LPG 1 | 1496 |
| Matrix CRDI | 1.5 | 81 | 09.01 - | D3EA | 3 | █ | Y-749J | 5013 | | | |
| Matrix (FC) | 1.6 | 76 | 08.01 - | G4ED | 4 | 1,1 | BKR5ES-11 | 2382 | 33 | LPG 1 | 1496 |
| Matrix (FC) | 1.8 | 98 | 07.01 - | G4GB | 4 | 1,1 | BKR5ES-11 | 2382 | 33 | LPG 1 | 1496 |
| Pony/Exel | 1.3 | | 85 - 94 | G13B/G4DG | 4 | 1,1 | BPR6ES-11 | 4824 | 13 | LPG 2 | 1497 |
| Pony/Exel | 1.5 | | 85 - 94 | G15B/G4DJ | 4 | 1,1 | BPR6ES-11 | 4824 | 13 | LPG 2 | 1497 |
| Pony/Exel | 1.5 | | 85 - 94 | G15B/G4DJ Cat. | 4 | 1,1 | BPR6ES-11 | 4824 | 13 | LPG 2 | 1497 |
| Porter | 2.4 | | | SOHC | 4 | 1,1 | BP6ES-11 | 1212 | | | |
| Porter H100 | 2.5 | | | 4D55 | 4 | █ | Y-115T1 | 2189 | | | |
| Presto | 1.3 | | | | 4 | 0,8 | BPR6ES | 7822 | 2 | LPG 2 | 1497 |
| Presto | 1.5 | | | | 4 | 0,8 | BPR6ES | 7822 | 2 | LPG 2 | 1497 |
| S Coupe | 1.5 | | 92 - | G15B | 4 | 1,1 | BKR5ES-11 | 2382 | 33 | LPG 1 | 1496 |
| S Coupe N/A | 1.5 | 65 | 04.92 - 05.96 | G4EK | 4 | 1,1 | BKR5ES-11 | 2382 | 33 | LPG 1 | 1496 |
| S Coupe Turbo | 1.5 | | 92 - | | 4 | 0,8 | BKR6ES | 3783 | 28 | LPG 1 | 1496 |
| S Coupe Turbo Charge | 1.5 | 85 | 04.91 - 05.98 | G4EK-TC | 4 | 0,8 | BKR6ES | 3783 | 28 | LPG 1 | 1496 |



ℓ kW

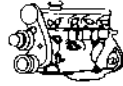

Cyl.

Order-
No.LPG/CNG
D-PowerOrder-
No.**HYUNDAI**

| | | | | | | | | | | | |
|---------------------|-----|-----|---------------|------------------|---|-----|-----------|------|----|------------|------|
| Santa Fe CRDi | 2.2 | 102 | 03.06 - | D4EB | 4 | █ | Y-749J | 5013 | | | |
| Santa Fe CRDi | 2.2 | 110 | 10.05 - | D4EB | 4 | █ | Y-749J | 5013 | | | |
| Santa Fe CRDi | 2.2 | 114 | 03.06 - | D4EB | 4 | █ | Y-749J | 5013 | | | |
| Santa Fe (CM) | 2.7 | 138 | 03.06 - | G6EA | 6 | 1,1 | ILFR5B11 | 1637 | | ILFR6B | 6481 |
| Santa Fe / SM | 2.4 | 107 | 02.01 - 05 | G4JS-G | 4 | 1,1 | PGR5C-11 | 5760 | | PGR5C-11 | 5760 |
| Santa Fe / SM | 2.7 | 127 | 02.01 - 05 | G6BA-G | 6 | 1,1 | PFR5N-11 | 5838 | | PFR5N-11 | 5838 |
| Santa Fe CRDi | 2.0 | 83 | 04.01 - 05 | D4EA | 4 | █ | Y-749J | 5013 | | | |
| Santa Fe CRDi 4x4 | 2.0 | 92 | 08.03 - | D4EA | 4 | █ | Y-749J | 5013 | | | |
| Santamo | 2.0 | 101 | 99-12.02 | G4CP DOHC / SOHC | 4 | 1,1 | BP6ES-11 | 1212 | | | |
| Sonata 1.8i | 1.8 | 70 | 89 - | G62B | 4 | 1,1 | BPR6ES-11 | 4824 | 13 | LPG 2 | 1497 |
| Sonata 2.0 CRDi | 2.0 | 103 | 02.06 - | D4EA | 4 | █ | Y-749J | 5013 | | | |
| Sonata 2.0 EF | 2.0 | 100 | 09.98 - 01 | G4JP-G DOHC | 4 | 1,1 | BPR6ES-11 | 4824 | 13 | LPG 2 | 1497 |
| Sonata 2.0i | 2.0 | 74 | 89 - 93 | 4G63 DOHC | 4 | 1,1 | BPR6ES-11 | 4824 | 13 | LPG 2 | 1497 |
| Sonata 2.0i | 2.0 | 77 | 06.94 - 96 | G4CP-D SOHC | 4 | 1,1 | BUR6EA-11 | 5428 | | | |
| Sonata 2.0i | 2.0 | | 93 - 98 | G4CP-D DOHC | 4 | 1,1 | BPR6ES-11 | 4824 | 13 | LPG 2 | 1497 |
| Sonata 2.4i | 2.4 | 120 | 89 - | 4G64 | 4 | 1,1 | BPR6ES-11 | 4824 | 13 | LPG 2 | 1497 |
| Sonata 2.4i | 2.4 | 121 | 08 - | | 4 | 1,1 | BKR5ES-11 | 2382 | 33 | LPG 1 | 1496 |
| Sonata 2.4i (NF) | 2.4 | 118 | 89 - 01 | G4KC | 4 | 1,1 | BKR5ES-11 | 2382 | 33 | LPG 1 | 1496 |
| Sonata 2.5 V6 | 2.5 | 118 | 09.98 - 01 | G6BV-EG DOHC | 6 | 1,1 | PFR5J-11 | 4642 | | PFR5J-11 | 4642 |
| Sonata 2.7 V6 | 2.7 | 127 | 10.01 - 11.04 | G6BA-G | 6 | 1,1 | PFR5B-11 | 2300 | | PFR6B | 3500 |
| Sonata 3.0 V6 | 3.0 | | 91 - 98 | G6AT | 6 | 1,1 | PGR5A-11 | 3573 | | PGR6A | 4984 |
| Sonata 3.3 | 3.3 | 184 | | | 6 | 1,1 | IFR5G11 | 7854 | | | |
| Sonata 3.3 V6 (NF) | 3.3 | 173 | 01.05 - 08 | G6DB | 6 | 1,1 | IFR5G11 | 7854 | | | |
| Starex | 2.4 | 82 | 02.98 - | SOHC | 4 | 1,1 | BP6ES-11 | 1212 | | | |
| Starex 2.5TD | 2.5 | 59 | 06.97 - | | 4 | █ | Y-722JS | 9974 | | | |
| Stellar 1.6 | 1.6 | 56 | 10.83 - 12.91 | | 4 | 0,8 | BP5ES | 6511 | 8 | LPG 2 | 1497 |
| Stellar 2.0 | 2.0 | | | | 4 | 0,8 | BP5ES | 6511 | 8 | LPG 2 | 1497 |
| Terracan | 2.9 | 120 | 11.03 - | J3 | 4 | █ | CY57 | 4994 | | D-POWER 21 | 4994 |
| Terracan (HP) 2.5TD | 2.5 | 74 | 06.01 - | D4BH | 4 | █ | CY57 | 4994 | | D-POWER 21 | 4994 |
| Terracan CRDi | 2.9 | 110 | 10.01 - | | 4 | █ | CY57 | 4994 | | D-POWER 21 | 4994 |
| Tiburon | 1.6 | | 00 - | DOHC | 4 | 1,1 | BKR5ES-11 | 2382 | 33 | LPG 1 | 1496 |
| Tiburon | 1.8 | | 00 - | DOHC | 4 | 1,1 | BKR5ES-11 | 2382 | 33 | LPG 1 | 1496 |
| Tiburon | 2.0 | | 00 - | DOHC | 4 | 1,1 | BKR5ES-11 | 2382 | 33 | LPG 1 | 1496 |
| Trajat CRDi | 2.0 | 83 | 04.01 - 04 | 4DEA | 4 | █ | Y-749J | 5013 | | | |
| Trajat / FO | 2.0 | 100 | 05.00 - | G4JP-G DOHC | 4 | 1,1 | BPR6ES-11 | 4824 | 13 | LPG 2 | 1497 |
| Trajat / FO | 2.0 | 103 | 01.04 - | | 4 | 1,1 | BKR5ES-11 | 2382 | 33 | LPG 1 | 1496 |
| Trajat / FO | 2.7 | 127 | 07.00 - | G6BA DOHC | 6 | 1,1 | PFR5N-11 | 5838 | | PFR5N-11 | 5838 |
| Tucson (JM) | 2.0 | 104 | 09.04 - | G4GC | 4 | 1,1 | BKR5ES-11 | 2382 | 33 | LPG 1 | 1496 |
| Tucson V6 (JM) | 2.7 | 129 | 09.04 - | G6BA | 6 | 1,1 | PFR5N-11 | 5838 | | PFR5N-11 | 5838 |
| Tucson D | 2.0 | 83 | 09.04 - | D4EA | 4 | █ | Y-749J | 5013 | | | |
| Tucson D | 2.0 | 103 | 02.06 - | D4EA | 4 | █ | Y-749J | 5013 | | | |
| X2 | 1.3 | | | | 4 | 1,1 | BPR6ES-11 | 4824 | 13 | LPG 2 | 1497 |
| X2 | 1.5 | | | | 4 | 1,1 | BPR6ES-11 | 4824 | 13 | LPG 2 | 1497 |
| XG 300 V6 | 3.0 | 138 | 99 - | G6CT-EG DOHC | 6 | 1,1 | PFR5N-11 | 5838 | | PFR5N-11 | 5838 |
| XG 350 V6 | 3.5 | 145 | 03 - | | 6 | 1,1 | PFR5N-11 | 5838 | | PFR5N-11 | 5838 |

INFINITI

| | | | | | | | | | | | |
|-------|-----|-----|---------|-----------|---|-----|-----------|------|--|----------|------|
| FX 25 | 3.5 | 206 | 05 - | VQ35DE V6 | 6 | 1,1 | PLFR5A-11 | 6240 | | LPG 7 | 1640 |
| FX 45 | 4.5 | 233 | 04 - | VK45DE V8 | 8 | 1,1 | PLFR5A-11 | 6240 | | LPG 7 | 1640 |
| G20 | 2.0 | | 91 - 94 | SR20DE | 4 | 1,1 | PFR5B-11 | 2300 | | PFR6B | 3500 |
| G20 | 2.0 | | 95 - 96 | SR20DE | 4 | 1,1 | PFR5B-11 | 2300 | | PFR6B | 3500 |
| G20 | 2.0 | | 99 - | SR20DE | 4 | 1,1 | PFR5G-11 | 2647 | | PFR6G-11 | 5555 |



ℓ kW

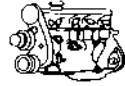

Cyl.

Order-
No. No.LPG/CNG
D-PowerOrder-
No.**INFINITI**

| | | | | | | | | | | | |
|-------|-----|--|---------|-----------|---|-----|-----------|------|----|----------|------|
| I30 | 3.0 | | 96 - 99 | VQ30DE V6 | 6 | 1,1 | PFR5G-11 | 2647 | | PFR6G-11 | 5555 |
| J30 | 3.0 | | 93 - 97 | VG30DE V6 | 6 | 1,1 | PFR5G-11 | 2647 | | PFR6G-11 | 5555 |
| M30 | 3.0 | | 90 - 92 | VG30E | 6 | 1,1 | PFR6B-11 | 4014 | | PFR7B | 4853 |
| Q45 | 4.1 | | 97 - 98 | VH41DE | 8 | 1,1 | PFR5G-11 | 2647 | | PFR6G-11 | 5555 |
| Q45 | 4.5 | | 90 - 93 | VH45D | 8 | 1,1 | PFR5B-11 | 2300 | | PFR6B | 3500 |
| Q45 | 4.5 | | 94 - 96 | VH45DE | 8 | 1,1 | PFR5G-11 | 2647 | | PFR6G-11 | 5555 |
| QX 56 | 5.6 | | 08 - | VK56DE FI | 8 | 1,1 | LFR5A-11 | 6376 | | LPG 7 | 1640 |
| QX4 | 3.3 | | 99 - | VD33DE | 6 | 1,0 | FR5AP-10 | 5463 | | | |
| QX4 | 3.3 | | 97 - 98 | VG33E | 6 | 1,1 | BKR5ES-11 | 2382 | 33 | LPG 1 | 1496 |
| QX4 | 3.5 | | 01 - | VQ35DE | 6 | 1,1 | PLFR5A-11 | 6240 | | LPG 7 | 1640 |

INNOCENTI

| | | | | | | | | | | | |
|------------------------------|-----|----|---------------|----------------|---|-----|--------|------|---|-----------|------|
| 500 L / SL | 0.5 | 23 | 87 - 07.90 | Daihatsu EB | 3 | 0,9 | BPR6EY | 6427 | | LPG 2 | 1497 |
| 650 / SE / (AD 10) | 0.6 | 23 | 11.84 - 04.86 | AD.. Daihatsu | 2 | 0,8 | BPR6ES | 7822 | 2 | LPG 2 | 1497 |
| 990 Matic / SE / SL / (CB22) | 1.0 | 38 | 05.86 - 12.90 | Z 670 Daihatsu | 4 | 0,8 | BPR5EY | 2828 | 9 | LPG 2 | 1497 |
| Clip ie | 1.0 | 35 | 09.95 - 06.97 | 146C7.000 | 4 | 0,9 | BPR5ES | 7422 | 6 | LPG 2 | 1497 |
| Clip ie Super | 1.4 | 51 | 09.95 - 06.97 | 160A1.046 | 4 | 0,8 | BPR6ES | 7822 | 2 | LPG 2 | 1497 |
| De Tomaso Turbo | 1.0 | 50 | 10.83 - 04.86 | Daihatsu CB 60 | 4 | 0,9 | BPR6EY | 6427 | | LPG 2 | 1497 |
| Elba | 1.3 | 49 | 07.91 - 08.93 | 146A5.000 | 4 | 0,8 | BPR6ES | 7822 | 2 | LPG 2 | 1497 |
| Elba D | 1.7 | 42 | 09.92 - | 146 B 2.000 | 4 | █ | Y-924J | 7906 | | D-POWER 1 | 7906 |
| Elba ie | 1.4 | 49 | 11.95 - 06.97 | 146C5.000 | 4 | 0,8 | BPR6ES | 7822 | 2 | LPG 2 | 1497 |
| Elba ie | 1.6 | 55 | 11.95 - 06.97 | 146C6.000 | 4 | 0,8 | BPR6ES | 7822 | 2 | LPG 2 | 1497 |
| Elba ie Happy | 1.6 | 55 | 06.95 - 06.96 | 146C6.000 | 4 | 0,8 | BPR6ES | 7822 | 2 | LPG 2 | 1497 |
| Koral 45 | 0.9 | 33 | 10.90 - 06.97 | 100GL 064 | 4 | 0,8 | BPR6ES | 7822 | 2 | LPG 2 | 1497 |
| Koral 55 | 1.1 | 41 | 10.90 - 06.97 | 128A 064 | 4 | 0,8 | BPR6ES | 7822 | 2 | LPG 2 | 1497 |
| Mille | 1.0 | 35 | 07.94 - 06.97 | 146C7.000 | 4 | 0,7 | BP6ES | 7811 | 4 | LPG 2 | 1497 |
| Mille i. | 1.0 | 35 | 07.94 - 06.97 | 146C7.000 | 4 | 0,9 | BPR5ES | 7422 | 6 | LPG 2 | 1497 |
| Mini Turbo de Tomaso | | | 83 - | | | 0,8 | BPR6EY | 6424 | | LPG 2 | 1497 |
| Mini 990 D | 1.0 | 27 | 01.82 - 12.90 | Daihatsu | 4 | █ | Y-146R | 7492 | | | |
| Minitre/SE/SE Special/SL | 1.0 | 40 | 06.84 - 04.86 | Daihatsu Z 670 | 4 | 0,8 | BPR5EY | 2828 | 9 | LPG 2 | 1497 |
| Small 500 L / LS | 0.6 | 23 | 01.91 - 06.97 | Daihatsu E | 3 | 0,9 | BPR6EY | 6427 | | LPG 2 | 1497 |
| Small 990 SE | 1.0 | 38 | 01.91 - 06.97 | Daihatsu CB | 3 | 0,8 | BPR5EY | 2828 | 9 | LPG 2 | 1497 |

ISUZU

| | | | | | | | | | | | |
|------------------|-----|-----|---------------|------------|---|-----|-----------|------|----|------------|------|
| Aska | 1.8 | 77 | - 12.93 | 4ZB1 | 4 | 1,1 | BPR5ES-11 | 4424 | | LPG 2 | 1497 |
| Aska Turbo | 2.0 | 110 | - 12.93 | 4ZC1 | 4 | 1,1 | BPR5ES-11 | 4424 | | LPG 2 | 1497 |
| Gemini | 1.5 | 54 | 05.87 - | 4XC1, 4XB1 | 4 | 0,8 | BP5ES | 6511 | 8 | LPG 2 | 1497 |
| Gemini D | 1.5 | 40 | 12.88 - | 4EC1 | 4 | █ | Y-710J | 7880 | | | |
| Gemini D | 1.5 | | 10.85 - 11.88 | 4EC1 | | █ | Y-306R | 6244 | | | |
| Gemini FF D | 1.5 | | 12.88 - | 4EC1 | 4 | █ | Y-710J | 7880 | | | |
| Gemini FF Turbo | 1.5 | | 12.88 - | 4EC1 | 4 | █ | Y-711J | 4467 | | D-POWER 28 | 4467 |
| Gemini TD | 1.5 | 49 | 02.88 - 12.88 | 4EC1T | 4 | █ | Y-307R | 5837 | | | |
| Gemini TD | 1.5 | | 12.88 - | 4EC1T | 4 | █ | Y-711J | 4467 | | D-POWER 28 | 4467 |
| Gemini 1.5 Turbo | 1.5 | 88 | 02.88 - | 4XC1UT | 4 | 1,1 | BPR6ES-11 | 4824 | 13 | LPG 2 | 1497 |
| Gemini 16V | 1.6 | 92 | 01.89 - | 4XE1-V | 4 | 1,1 | BPR6ES-11 | 4824 | 13 | LPG 2 | 1497 |
| Gemini 16V | 1.6 | 92 | 01.89 - | 4XE1-W | 4 | 1,1 | BKR6E-11 | 2756 | 14 | LPG 1 | 1496 |
| Light Bus BE | | | 80 - | 4BD1 | | █ | Y-271-2 | 7467 | | | |
| Light Bus BL | | | 07.81 - | 4BC1 | | █ | Y-271-2 | 7467 | | | |
| Light Bus BL | | | 07.81 - | 4BC2 | | █ | Y-271-2 | 7467 | | | |
| Midi D 11V | 2.2 | 45 | 01.86 - | | 4 | █ | Y-711J | 4467 | | D-POWER 28 | 4467 |
| Midi D 5V | 2.2 | 45 | 01.86 - | | 4 | █ | Y-307R | 5837 | | | |
| Midi TD 11V | 2.0 | 51 | 01.86 - | | 4 | █ | Y-711J | 4467 | | D-POWER 28 | 4467 |



ℓ kW

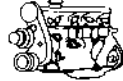

Cyl.

Order-
No.VLINE
No.LPG/CNG
D-PowerOrder-
No.**ISUZU**

| | | | | | | | | | | | |
|-------------------|-----|-----|---------------|-----------|---|-----|-----------|------|----|------------|------|
| Midi TD 5V | 2.0 | 51 | 01.86 - | | 4 | █ | Y-307R | 5837 | | | |
| Piazza | 2.0 | 100 | 06.81 - | G200Z | 4 | 1,1 | BP5ES-11 | 7311 | | LPG 2 | 1497 |
| Piazza Turbo | 2.0 | 132 | -12.90 | 4ZCI | 4 | 0,8 | BPR6ES | 7822 | 2 | LPG 2 | 1497 |
| Pickup D | 2.0 | | 01.83 - | C190 | 4 | █ | Y-306R | 6244 | | | |
| Pickup D | 2.2 | 53 | 08.87 - 10.88 | C223 | 4 | █ | Y-710J | 7880 | | | |
| Pickup D | 2.2 | | 08.86 - 08.87 | C223 | 4 | █ | Y-306R | 6244 | | | |
| Rodeo | 3.2 | 151 | 98 - | V DOHC | 6 | 1,1 | PFR5G-11 | 2647 | | PFR6G-11 | 5555 |
| Trooper | 2.3 | 66 | 01.87 - | 4ZD1 Cat. | 4 | 1,1 | BPR6ES-11 | 4824 | 13 | LPG 2 | 1497 |
| Trooper | 2.3 | | 87 - | | 4 | 0,8 | BPR6ES | 7822 | 2 | LPG 2 | 1497 |
| Trooper | 2.3 | | 88 - | 4ZD1 | 4 | 0,8 | BPR6ES | 7822 | 2 | LPG 2 | 1497 |
| Trooper | 2.6 | 85 | 10.87 - | 4ZE1 Cat. | 4 | 1,1 | BPR6ES-11 | 4824 | 13 | LPG 2 | 1497 |
| Trooper | 3.5 | 158 | 04.00 - | 6VE1 V6 | 6 | 1,1 | PFR6B-11 | 4014 | | PFR7B | 4853 |
| Trooper D | 2.3 | 39 | 08.87 - 10.88 | C223 | 4 | █ | Y-710J | 7880 | | | |
| Trooper D | 2.3 | | 02.81 - 07.87 | C223 | 4 | █ | Y-306R | 6244 | | | |
| Trooper TD | 2.3 | 53 | 08.87 - 10.88 | C223T | 4 | █ | Y-710J | 7880 | | | |
| Trooper TD | 3.1 | 83 | 06.92 - | 4JG2T | 4 | █ | Y-711J | 4467 | | D-POWER 28 | 4467 |
| Trooper 2.2 | 2.2 | 66 | -10.88 | 4ZD1 | 4 | 0,8 | BPR6ES | 7822 | 2 | LPG 2 | 1497 |
| Trooper TD | 2.3 | | 02.81 - 07.87 | C223T | 4 | █ | Y-306R | 6244 | | | |
| Trooper TD | 2.8 | 71 | 10.87 - 12.91 | 4JB1T | 4 | █ | Y-904M | 4334 | | | |
| Trooper TD | 2.8 | 78 | 10.88 - 12.91 | 4JB1TC | 4 | █ | Y-904M | 4334 | | | |
| Vehicross 3.2 24V | 3.2 | 158 | 03.97 - | 6VDI | 6 | 1,1 | BKR6E-11 | 2756 | 14 | LPG 1 | 1496 |

IVECO

| | | | | | | | | | | | |
|-------------------|-----|----|---------------|-------------------|---|---|--------|------|--|-----------|------|
| Daily 28.40 F 8 | | | 07.82 - 12.82 | | | █ | Y-208T | 1250 | | | |
| Daily D30/35/40-8 | 2.4 | 53 | 10.83 - 06.89 | Sofim 8140.61.200 | 4 | █ | Y-908R | 4585 | | D-POWER 1 | 7906 |
| Daily TDi | 2.8 | 90 | 09.97 - | | 6 | █ | Y-502R | 3852 | | | |

JAGUAR

| | | | | | | | | | | | |
|---------------|-----|-----|---------------|------------------|----|-----|-----------|------|----|---------|------|
| Double Six | 5.3 | | 90 - | V 12 HE | 12 | 0,6 | BR7EF | 3346 | | | |
| Sovereign 2.9 | 2.9 | | 08.86 - 08.90 | AJ6 SOHC | 6 | 0,8 | B8ES | 2411 | | BR8EIX | 5044 |
| Sovereign 3.2 | 3.2 | | 07.90 - 07.97 | AJ6 | 6 | 0,8 | BCPR6ES | 2330 | 12 | LPG 3 | 1498 |
| Sovereign 3.6 | 3.6 | | 08.86 - 08.89 | AJ6 | 6 | 0,8 | BCPR6ES | 2330 | 12 | LPG 3 | 1498 |
| Sovereign 4.0 | 4.0 | | 09.89 - 09.97 | AJ6 | 6 | 0,8 | BCPR6ES | 2330 | 12 | LPG 3 | 1498 |
| Sovereign V12 | 5.3 | | 81 - 90 | V12 HE | 12 | 0,6 | BR7EFS | 1094 | | | |
| S-Type 2.7D | 2.7 | 152 | 06.04 - | | 6 | █ | YE12 | 7794 | | | |
| S-Type 4.2 V8 | 4.2 | | 03.02 - | AJ-V8 | 8 | 1,0 | IFR5N10 | 7866 | | | |
| S-Type R | 4.2 | | 03.02 - | AJ28 | 8 | 1,0 | IFR5N10 | 7866 | | | |
| S-Type R | 4.2 | | 03.02 - | AJ-V8 | 8 | 1,0 | IFR5N10 | 7866 | | | |
| S-Type V6 | 2.5 | 143 | 02.01 - | AJV6 | 6 | 1,3 | PTR6D-13 | 5598 | | | |
| S-Type V6 | 3.0 | 175 | 10.98 - | FC AJ-V6 | 6 | 1,3 | PTR6D-13 | 5598 | | LPG 5 | 1516 |
| S-Type V8 | 4.0 | 203 | 03.00 - 03.02 | GC AJ-V8 | 8 | 1,1 | PFR5G-11E | 3000 | | | |
| S-Type V8 | 4.0 | 203 | 10.98 - 03.00 | GC AJ-V8 | 8 | 1,3 | PFR5G-13E | 2761 | | | |
| XJ12 | 5.3 | | 82 - 85 | HE(V12) | 12 | 0,6 | BR6EF | 3177 | | | |
| XJ12 | 5.3 | | 86 - 90 | HE(V12) | 12 | 0,6 | BR7EF | 3346 | | | |
| XJ12 | 5.3 | | 91 - 93 | HE(V12) | 12 | 0,6 | BR7EF | 3346 | | | |
| XJ12 | 5.3 | | - 81 | V12 | 12 | 0,8 | BP5E | 4669 | 8 | BPR5EIX | 6597 |
| XJ12 | 6.0 | | 93 - 11.94 | HE(V12) | 12 | 0,6 | BR7EF | 3346 | | | |
| XJ12 | 6.0 | | 11.94 - 09.96 | HE(V12) | 12 | 0,6 | BR6EF | 3177 | | | |
| XJ12 | 6.0 | | 92 - 11.94 | V12 | 12 | 0,6 | BR7EF | 3346 | | | |
| XJ12 | 6.0 | | 11.94 - 09.96 | V12 | 12 | 0,6 | BR6EF | 3177 | | | |
| XJ6 | 3.0 | | 03.03 - | AJ-V6 | 6 | 1,3 | PTR6D-13 | 5598 | | LPG 5 | 1516 |
| XJ6 | 3.2 | | 07.90 - 07.97 | AJ6 Cat./ 9BPMNA | 6 | 0,8 | BCPR6ES | 2330 | 12 | LPG 3 | 1498 |



l kW



Cyl.

Order-
No. No.LPG/CNG
D-PowerOrder-
No.**JAGUAR**

| | | | | | | | | | | | |
|-----------------------|-----|-----|---------------|-----------------|----|-----|-------------|------|----|---------|------|
| XJ6 | 3.6 | 136 | 08.86 - 05.92 | AJ6 / 9DPANA | 6 | 0,8 | BCPR6ES | 2330 | 12 | LPG 3 | 1498 |
| XJ6 | 4.0 | | 09.89 - 09.97 | AJ6 Cat. | 6 | 0,8 | BCPR6ES | 2330 | 12 | LPG 3 | 1498 |
| XJ6 2.9 | 2.9 | | 08.86 - 08.90 | AJ6 SOHC | 6 | 0,8 | B8ES | 2411 | | BR8EIX | 5044 |
| XJ6 V12 | 5.3 | | 01.91 - | V12 | 12 | 0,6 | BR7EFS | 1094 | | | |
| XJ8 | 3.2 | 174 | 09.97 - 09.98 | V8 | 8 | 1,3 | BKR6EVXA-13 | 2563 | | | |
| XJ8 | 3.2 | 176 | 09.97 - | | 8 | 1,3 | BKR6EVXA-13 | 2563 | | | |
| XJ8 | 3.2 | | 03.00 - 03.02 | AJ26 | 8 | 1,1 | PFR5G-11E | 3000 | | | |
| XJ8 | 3.2 | | 03.02 - | AJ26 | 8 | 1,0 | IFR5N10 | 7866 | | | |
| XJ8 | 3.2 | | 09.97 - 09.98 | AJ26 | 8 | 1,3 | BKR5EVXA-13 | 1188 | | | |
| XJ8 | 3.2 | | 09.98 - 03.00 | AJ26 | 8 | 1,3 | PFR5G-13E | 2761 | | | |
| XJ8 | 3.5 | | 03.02 - | AJ26 | 8 | 1,0 | IFR5N10 | 7866 | | | |
| XJ8 | 3.5 | | 03.03 - | AJ33 | 8 | 1,0 | IFR5N10 | 7866 | | | |
| XJ8 | 4.0 | 209 | 09.97 - | V8 | 8 | 1,3 | BKR6EVXA-13 | 2563 | | | |
| XJ8 | 4.0 | | 03.00 - 03.02 | AJ26 | 8 | 1,1 | PFR5G-11E | 3000 | | | |
| XJ8 | 4.0 | | 03.02 - | AJ26 | 8 | 1,0 | IFR5N10 | 7866 | | | |
| XJ8 | 4.0 | | 09.97 - 09.98 | AJ26 | 8 | 1,3 | BKR5EVXA-13 | 1188 | | | |
| XJ8 | 4.0 | | 09.98 - 03.00 | AJ26 | 8 | 1,3 | PFR5G-13E | 2761 | | | |
| XJ8 | 4.2 | | 03.02 - | AJ26 | 8 | 1,0 | IFR5N10 | 7866 | | | |
| XJ8 | 4.2 | | 03.03 - | AJ33 | 8 | 1,0 | IFR5N10 | 7866 | | | |
| XJ8 Supercharged | 4.2 | | 03.03 - | AJ33 | 8 | 1,0 | IFR5N10 | 7866 | | | |
| XJ8R | 4.0 | 272 | 09.97 - 03.00 | | 8 | 1,3 | PFR6G-13E | 2341 | | | |
| XJ8R | 4.0 | | 03.02 - | AJ26 | 8 | 1,0 | IFR5N10 | 7866 | | | |
| XJ8R 4.0 | 4.0 | | 03.00 - 03.02 | AJ26 | 8 | 1,1 | PFR5G-11E | 3000 | | | |
| XJ8R 4.2 | 4.2 | | 03.02 - | | 8 | 1,0 | IFR5N10 | 7866 | | | |
| XJ8R Supercharged | 4.0 | | 09.97 - 02.00 | AJ26 | 8 | 1,3 | PFR6G-13E | 2341 | | | |
| XJR | 3.6 | | 11.88 - 09.89 | AJ6 | 6 | 0,8 | BCPR6E | 1269 | 12 | LPG 3 | 1498 |
| XJR 4.0 | 4.0 | | 09.89 - 09.94 | AJ6 | 6 | 0,8 | BCPR6ES | 2330 | 12 | LPG 3 | 1498 |
| XJR Supercharged X300 | 4.0 | 235 | 08.94 - 08.97 | AJ16 Kompressor | 6 | 0,9 | BKR7E | 6097 | | BKR7EVX | 3544 |
| XJR V8 (X300) | 4.0 | 267 | 09.97 - 02.00 | AJ26 | 8 | 1,3 | PFR6G-13E | 2341 | | | |
| XJS | 5.3 | | 82 - 85 | HE(V12) | 12 | 0,6 | BR6EF | 3177 | | | |
| XJS | 5.3 | | 86 - 90 | HE(V12) | 12 | 0,6 | BR7EF | 3346 | | | |
| XJS | 5.3 | | - 81 | V12 | 12 | 0,8 | BP5E | 4669 | 8 | BPR5EIX | 6597 |
| XJS | 5.3 | | 81 - 90 | V12 HE | 12 | 0,6 | BR7EFS | 1094 | | | |
| XJS | 5.3 | | 91 - 93 | V12 HE | 12 | 0,6 | BR7EF | 3346 | | | |
| XJS 3.6 | 3.6 | | 08.86 - 05.91 | AJ6 | 6 | 0,8 | BCPR6ES | 2330 | 12 | LPG 3 | 1498 |
| XJS Coupe | 4.0 | | 04.91 - 09.96 | AJ6 | 6 | 0,8 | BCPR6ES | 2330 | 12 | LPG 3 | 1498 |
| XJS V12 | 6.0 | | 05.93 - 11.94 | V12 | 12 | 0,6 | BR7EF | 3346 | | | |
| XJS V12 | 6.0 | | 11.94 - 05.95 | V12 | 12 | 0,6 | BR6EF | 3177 | | | |
| XK8 | 4.0 | 213 | 10.96 - 09.97 | AJ / V8 | 8 | 1,1 | BKR6EVXA-11 | 6838 | | | |
| XK8 | 4.0 | 213 | 09.97 - 09.98 | AJ26 | 8 | 1,3 | BKR5EVXA-13 | 1188 | | | |
| XK8 | 4.0 | 389 | 10.96 - 09.97 | AJ26 | 8 | 1,1 | BKR6EVXA-11 | 6838 | | | |
| XK8 | 4.0 | | 03.00 - | AJ26 | 8 | 1,1 | PFR5G-11E | 3000 | | | |
| XK8 | 4.0 | | 09.98 - 03.00 | AJ26 | 8 | 1,3 | PFR5G-13E | 2761 | | | |
| XK8 | 4.0 | | 03.00 - 02.02 | AJ27 | 8 | 1,1 | PFR5G-11E | 3000 | | | |
| XK8 | 4.0 | | 03.02 - | AJ27 | 8 | 1,0 | IFR5N10 | 7866 | | | |
| XK8 | 4.0 | | 09.97 - 09.98 | AJ27 | 8 | 1,3 | BKR5EVXA-13 | 1188 | | | |
| XK8 | 4.0 | | 09.98 - 03.00 | AJ27 | 8 | 1,3 | PFR5G-13E | 2761 | | | |
| XK8 | 4.2 | | 09.02 - | AJ34 | 8 | 1,0 | IFR5N10 | 7866 | | | |
| XKR | 4.0 | 267 | 03.00 - 02.02 | AJ27 | 8 | 1,1 | PFR5G-11E | 3000 | | | |
| XKR | 4.0 | 267 | 05.98 - 03.00 | AJ27 | 8 | 1,3 | PFR6G-13E | 2341 | | | |
| XKR | 4.0 | | 03.02 - | AJ27 | 8 | 1,0 | IFR5N10 | 7866 | | | |
| XKR | 4.2 | | 09.02 - | AJ34 | 8 | 1,0 | IFR5N10 | 7866 | | | |



ℓ kW

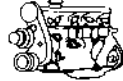

Cyl.

Order-
No.V-LINE
No.LPG/CNG
D-PowerOrder-
No.**JAGUAR**

| | | | | | | | | | | | |
|-------------|-----|-----|---------------|-------|---|-----|----------|------|--|------------|------|
| X-Type 2.0 | 2.0 | 117 | 12.01 - | AJ-V6 | 6 | 1,3 | PTR6D-13 | 5598 | | LPG 5 | 1516 |
| X-Type 2.0D | 2.0 | 96 | 07.03 - 10.05 | | 4 | ■ | Y-525J | 4090 | | D-POWER 35 | 4090 |
| X-Type 2.5 | 2.5 | 140 | 02.01 - | AJ-V6 | 6 | 1,3 | PTR6D-13 | 5598 | | LPG 5 | 1516 |
| X-Type 3.0 | 3.0 | 173 | 02.01 - | AJ-V6 | 6 | 1,3 | PTR6D-13 | 5598 | | LPG 5 | 1516 |

JEEP

| | | | | | | | | | | | |
|-----------------------------|-----|-----|---------------|--------------------------|---|-----|------------|------|--|------------|------|
| Cherokee | 2.4 | 108 | 08.01 - | | 4 | 1,1 | LZTR4A-11 | 5444 | | | |
| Cherokee | 2.5 | | 84 - 85 | L4 1Bbl U | 4 | 1,1 | ZFR5A-11 | 5084 | | LPG 6 | 1565 |
| Cherokee | 2.5 | | 90 - 98 | L4 MPI P | 4 | 0,9 | FR5-1 | 7252 | | | |
| Cherokee | 2.5 | | 89 - 90 | L4 TBI E | 4 | 0,9 | FR5-1 | 7252 | | | |
| Cherokee | 2.5 | | 86 - 88 | L4 TBI H | 4 | 0,9 | FR5-1 | 7252 | | | |
| Cherokee | 2.8 | | 84 - 86 | L6 2Bbl W | 6 | 1,1 | UR4 | 4762 | | UR5IX | 7177 |
| Cherokee | 4.0 | | 89 - 90 | L6 MPI L | 6 | 0,9 | FR5 | 4876 | | | |
| Cherokee | 4.0 | | 87 - 88 | L6 MPI M | 6 | 0,9 | FR5 | 4876 | | | |
| Cherokee | 4.2 | | 81 - 83 | L6 2Bbl C | 6 | 1,1 | ZFR5A-11 | 5084 | | LPG 6 | 1565 |
| Cherokee 3.7 V6 | 3.7 | 154 | 10.01 - | | 6 | 1,1 | ZFR5F-11 | 2262 | | LPG 6 | 1565 |
| Cherokee Td | | | 04.84 - 12.87 | Renault | 4 | ■ | Y-908R | 4585 | | D-POWER 1 | 7906 |
| Cherokee TD | 2.1 | 59 | 01.88 - | | 6 | ■ | Y-908R | 4585 | | D-POWER 1 | 7906 |
| Cherokee TD | 2.1 | 65 | 02.91 - 08.94 | J8S 890 | 4 | ■ | Y-913M | 3965 | | D-POWER 15 | 5317 |
| Cherokee TD | 2.1 | 65 | 01.87 - 01.91 | Renault J8S 814, J8S 890 | 4 | ■ | Y-908R | 4585 | | D-POWER 1 | 7906 |
| Cherokee TD | 2.5 | 85 | 05.95 - 07.99 | VM HR 425 | 4 | ■ | Y-741U | 6943 | | D-POWER 20 | 6943 |
| CJ | 2.5 | 65 | 80 - 83 | L4 2Bbl B | 4 | 1,5 | UR45 | 2451 | | UR5IX | 7177 |
| CJ | 2.5 | 78 | 84 - 86 | L4 1Bbl U | 4 | 1,1 | ZFR5A-11 | 5084 | | LPG 6 | 1565 |
| CJ | 4.2 | 76 | 81 - 86 | L6 2Bbl C | 6 | 1,1 | ZFR5A-11 | 5084 | | LPG 6 | 1565 |
| Commanche | 2.5 | | 91 - 92 | L4 MPI P | 4 | 0,9 | FR5-1 | 7252 | | | |
| Commanche | 2.5 | | 90 - 89 | L4 TBI E | 4 | 0,9 | FR5-1 | 7252 | | | |
| Commanche | 2.5 | | 86 - 88 | L4 TBI H | 4 | 0,9 | FR5-1 | 7252 | | | |
| Commanche | 2.8 | | 86 - 86 | V6 2Bbl W | 6 | 1,1 | UR4 | 4762 | | UR5IX | 7177 |
| Commanche | 4.0 | | 89 - 90 | L6 MPI L | 6 | 0,9 | FR5-1 | 7252 | | | |
| Commanche | 4.0 | | 87 - 88 | L6 MPI M | 6 | 0,9 | FR5-1 | 7252 | | | |
| Commanche | 4.0 | | 91 - 92 | L6 MPI S | 6 | 0,9 | FR5-1 | 7252 | | | |
| Commander 3.0 CRD | 3.0 | 160 | 06 - | Mercedes | 6 | ■ | Y-745U | 6346 | | D-POWER 11 | 6346 |
| Compass CRD | 2.0 | 103 | 06 - | | 4 | ■ | GZ304 | 9864 | | D-POWER 55 | 9864 |
| Grand Cherokee | 5.7 | 240 | 05 - | V8 2 FI | 8 | 1,1 | LZTR4A-11 | 5444 | | | |
| Grand Cherokee | 3.7 | | 05 - | V6 K FI | 6 | 1,1 | PZFR6F-11 | 3271 | | LPG 6 | 1565 |
| Grand Cherokee | 4.0 | | 03 - 04 | L6 S FI | 6 | 0,8 | ZFR5N | 3459 | | | |
| Grand Cherokee | 4.0 | | 91 - 98 | L6 S MPI | 6 | 0,9 | FR5-1 | 7252 | | | |
| Grand Cherokee | 4.7 | 173 | 02.99 - 99 | V8 N MPI | 8 | 1,1 | PZFR6F-11 | 3271 | | LPG 6 | 1565 |
| Grand Cherokee | 4.7 | | 02 - 04 | V8 J FI SOHC&H.O. | 8 | 0,9 | BKR7E | 6097 | | BKR8EIX | 2668 |
| Grand Cherokee | 4.7 | | 05 - | V8 N FI | 8 | 1,1 | PZFR6F-11 | 3271 | | LPG 6 | 1565 |
| Grand Cherokee | 4.7 | | 00 - 04 | V8 N FI SOHC | 8 | 1,1 | PZFR6F-11 | 3271 | | LPG 6 | 1565 |
| Grand Cherokee | 5.2 | | 93 - 96 | V8 Y MPI | 8 | 0,9 | FR4 | 5188 | | | |
| Grand Cherokee | 5.2 | | 97 - 98 | V8 Y MPI | 8 | 0,9 | FR5-1 | 7252 | | | |
| Grand Cherokee | 5.9 | | 98 - | V8 MPI Z | 8 | 1,0 | FR5-1 | 7252 | | | |
| Grand Cherokee TD | 2.5 | 88 | 01.93 - | VM HR 425 CLIRE | 4 | ■ | Y-923U | 3380 | | D-POWER 1 | 7906 |
| Grand Cherokee TD | 2.5 | 110 | 04.99 - | ENC | 4 | ■ | Y-741U | 6943 | | D-POWER 20 | 6943 |
| Grand Cherokee TD / Limited | 3.1 | 103 | 04.98 - | EXA | 5 | ■ | Y-741U | 6943 | | D-POWER 20 | 6943 |
| Grand Cherokee SRT-8 | 6.1 | 313 | 08.06 - | | 8 | 1,3 | PLZTR5A-13 | 4998 | | | |
| Grand Cherokee TD | 2.5 | 88 | 01.93 - | VM HR-492 | 4 | ■ | Y-923U | 3380 | | D-POWER 1 | 7906 |
| Grand Voyager 2.5 Td Le | 2.5 | 88 | 05.95 - | VM HR425 CLIEE | 4 | ■ | Y-741U | 6943 | | D-POWER 20 | 6943 |
| Grand Wagoneer | 5.2 | | 93 - 93 | V8 MPI Y | 8 | 0,9 | FR4 | 5188 | | | |
| Grand Wagoneer | 5.9 | | 89 - 91 | V8 2Bbl 7 | 8 | 0,9 | GR4 | 7038 | | GR5IX | 7214 |



ℓ kW



Cyl.

Order-
No. No.LPG/CNG
D-PowerOrder-
No.**JEEP**

| | | | | | | | | | | | |
|-----------------------------------|-----|-----|---------------|-----------------|---|-----|-----------|------|--|-----------|------|
| Grand Wagoneer | 5.9 | | 97 - | V8 MPI Z | 8 | 0,9 | FR4 | 5188 | | | |
| J Serie | 4.2 | | 81 - 88 | L6 2Bbl C | 6 | 1,1 | ZFR5A-11 | 5084 | | LPG 6 | 1565 |
| Liberty | 2.4 | | 02 - | L4 1 FI | 4 | 1,1 | LZTR4A-11 | 5444 | | | |
| Liberty | 3.7 | | 02 - | V6 K FI | 6 | 1,1 | PZFR6F-11 | 3271 | | LPG 6 | 1565 |
| Wagoneer | 2.5 | | 84 - 85 | L4 1Bbl U | 4 | 1,1 | ZFR5A-11 | 5084 | | LPG 6 | 1565 |
| Wagoneer | 2.5 | | 91 - 92 | L4 MPI P | 4 | 0,9 | FR5-1 | 7252 | | | |
| Wagoneer | 2.5 | | 89 - 90 | L4 TPI E | 4 | 0,9 | FR5-1 | 7252 | | | |
| Wagoneer | 2.5 | | 86 - 88 | L4 TPI H | 4 | 0,9 | FR5-1 | 7252 | | | |
| Wagoneer | 2.8 | | 84 - 86 | V6 W | 6 | 1,1 | UR4 | 4762 | | UR5IX | 7177 |
| Wagoneer | 4.0 | | 89 - 90 | L6 L | 6 | 0,9 | FR5-1 | 7252 | | | |
| Wagoneer | 4.0 | | 87 - 88 | L6 M | 6 | 0,9 | FR5-1 | 7252 | | | |
| Wagoneer | 4.0 | | 91 - 92 | L6 MPI S | 6 | 0,9 | FR5-1 | 7252 | | | |
| Wagoneer | 4.2 | | 80 - 85 | L6 2Bbl C | 6 | 1,1 | ZFR5A-11 | 5084 | | LPG 6 | 1565 |
| Wagoneer | 5.9 | | 80 - 85 | V8 N | 8 | 0,9 | GR4 | 7038 | | GR5IX | 7214 |
| Wrangler | 2.5 | | 07.88 - | | 6 | █ | Y-908R | 4585 | | D-POWER 1 | 7906 |
| Wrangler | 2.5 | | 87 - 88 | L4 H | 4 | 0,9 | FR5-1 | 7252 | | | |
| Wrangler | 2.5 | | 91 - 01.01 | L4 MPI P | 4 | 0,9 | FR5-1 | 7252 | | | |
| Wrangler | 2.5 | | 89 - 90 | L4 TBI H | 4 | 0,9 | FR5-1 | 7252 | | | |
| Wrangler | 4.0 | 135 | 91 - | L6 MPI | 6 | 1,1 | ZFR5A-11 | 5084 | | LPG 6 | 1565 |
| Wrangler | 4.0 | | 91 - 95 | L6 MPI S | 6 | 0,9 | FR5-1 | 7252 | | | |
| Wrangler | 4.0 | | 98 - 02 | L6 MPI S | 6 | 0,9 | FR5-1 | 7252 | | | |
| Wrangler | 4.0 | | 96 - 97 | L6 MPI V | 6 | 0,9 | FR5-1 | 7252 | | | |
| Wrangler | 4.2 | | 87 - 88 | L6 C | 6 | 1,1 | ZFR5A-11 | 5084 | | LPG 6 | 1565 |
| Wrangler | 4.2 | | 88 - 89 | L6 M | 6 | 1,1 | ZFR5A-11 | 5084 | | LPG 6 | 1565 |
| Wrangler | 4.2 | | 90 - 90 | L6 T | 6 | 1,1 | ZFR5A-11 | 5084 | | LPG 6 | 1565 |
| Wrangler Laredo, Sahara, Texan TD | 2.1 | 65 | 07.88 - | | 4 | █ | Y-908R | 4585 | | D-POWER 1 | 7906 |
| Wrangler Rubicon 3.8 | 3.8 | 146 | 07 - | V6 FI | 6 | 1,3 | LZTR5A-13 | 4612 | | | |
| Wrangler Unlimited | 3.8 | 151 | 07 - | | 6 | 1,3 | LZTR5A-13 | 4612 | | | |
| Wrangler, Laredo, Sahara | 2.5 | | 07.88 - | | 6 | █ | Y-908R | 4585 | | D-POWER 1 | 7906 |
| Wrangler, Texan D | 2.5 | | 07.88 - | | 6 | █ | Y-908R | 4585 | | D-POWER 1 | 7906 |
| XJ Cherokee TD | 2.0 | 64 | 04.84 - 12.87 | Renault J8S-814 | 4 | █ | Y-908R | 4585 | | D-POWER 1 | 7906 |
| XJ Cherokee TD | 2.4 | 64 | 04.84 - 12.87 | | 4 | █ | Y-908R | 4585 | | D-POWER 1 | 7906 |

KIA

| | | | | | | | | | | | |
|---------------------|-----|-----|---------------|----------|---|-----|-----------|------|----|------------|------|
| Avella | 1.3 | | | | 4 | 1,1 | BPR5EY-11 | 3028 | | LPG 2 | 1497 |
| Avella | 1.5 | | | | 4 | 1,1 | BPR5ES-11 | 4424 | | LPG 2 | 1497 |
| Besta | 2.2 | 48 | 02.96 - | R2 | 4 | █ | Y-701J | 1566 | | D-POWER 39 | 1566 |
| Besta 2.2 | 2.2 | 52 | 03.90 - 07.99 | HW | 4 | █ | Y-701J | 1566 | | D-POWER 39 | 1566 |
| Besta 2.2 | 2.2 | | | | 4 | 0,7 | BP6ES | 7811 | 4 | LPG 2 | 1497 |
| Besta 2.7 | 2.7 | 60 | 03.90 - 07.99 | VN | 4 | █ | Y-701J | 1566 | | D-POWER 39 | 1566 |
| Bongo | 2.4 | | | E-2400 | 4 | █ | Y-107T | 1253 | | | |
| Carens 1.6 | 1.6 | 77 | 06.02 - | S6D | 4 | 1,1 | BKR6ES-11 | 5553 | 14 | LPG 1 | 1496 |
| Carens 1.8 | 1.8 | 81 | 01 - | | 4 | 0,9 | BKR6E | 6962 | 28 | LPG 1 | 1496 |
| Carens 1.8 | 1.8 | 93 | 06.02 - | TB | 4 | 0,8 | BKR6ES | 3783 | 28 | LPG 1 | 1496 |
| Carens 2.0 CRDi EX | 2.0 | 83 | 02 - | D4EA | 4 | █ | Y-749J | 5013 | | | |
| Carens II 2.0 | 2.0 | 102 | 08.04 - | G4GC | 4 | 1,1 | BKR5ES-11 | 2382 | 33 | LPG 1 | 1496 |
| Carens III | 2.0 | 106 | 09.06 - | G4KA | 4 | 1,1 | BKR5ES-11 | 2382 | 33 | LPG 1 | 1496 |
| Carens III CRDi 2.0 | 2.0 | 103 | 06 - | D4EA | 4 | █ | Y-749J | 5013 | | | |
| Carnival 2.5 | 2.5 | 121 | 12.98 - 01 | K5 | 6 | 1,1 | PFR6N-11 | 3546 | | LPG 1 | 1496 |
| Carnival 2.5 | 2.5 | 129 | 12.98 - 01 | KV5 DOHC | 6 | 1,1 | PFR6N-11 | 3546 | | LPG 1 | 1496 |
| Carnival II 2.5 | 2.5 | 110 | 10.01 - | | 6 | 1,1 | PFR6N-11 | 3546 | | LPG 1 | 1496 |
| Carnival II 2.7 | 2.7 | 139 | 06.06 - | G6EA V6 | 6 | 1,1 | ILFR5B11 | 1637 | | ILFR6B | 6481 |



ℓ kW

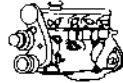

Cyl.

Order-
No.VLINE
No.LPG/CNG
D-PowerOrder-
No.**KIA**

| | | | | | | | | | | | |
|---------------------|-----|-----|---------------|----------|---|-----|-----------|------|----|------------|------|
| Cee'd 1.4 | 1.4 | 80 | 01.07 - | G4FA | 4 | 0,7 | ZFR5F | 5165 | | LPG 6 | 1565 |
| Cee'd 1.6 | 1.6 | 90 | 01.07 - | G4FC | 4 | 0,7 | ZFR5F | 5165 | | LPG 6 | 1565 |
| Cee'd 2.0 | 2.0 | 105 | 01.07 - | G4GC | 4 | 0,8 | BKR5ES | 2460 | 35 | LPG 1 | 1496 |
| Cee'd 2.0 CRDi | 2.0 | 103 | 01.07 - | D4EA-F | 4 | █ | Y-748U | 6649 | | D-POWER 14 | 6649 |
| Cerato 2.0 CRDi | 2.0 | 83 | 04.04 - | D4EA | 4 | █ | Y-749J | 5013 | | | |
| Cerato 1.6 | 1.6 | 77 | 05.04 - | G4ED | 4 | 1,1 | BKR5ES-11 | 2382 | 33 | LPG 1 | 1496 |
| Cerato 2.0 | 2.0 | 106 | 05.04 - | G4GC | 4 | 1,1 | BKR5ES-11 | 2382 | 33 | LPG 1 | 1496 |
| Clarus 1.8 | 1.8 | 85 | 06.96 - 01 | T8 DOHC | 4 | 0,8 | BKR5E | 7938 | 35 | LPG 1 | 1496 |
| Clarus 2.0 | 2.0 | 98 | 09.96 - 01 | FE DOHC | 4 | 1,1 | BK6E-11 | 7340 | | LPG 1 | 1496 |
| Joice | 2.0 | 103 | 09.01 - 03 | G4CP | 4 | 1,1 | BPR6ES-11 | 4824 | 13 | LPG 2 | 1497 |
| K 2500 | 2.5 | 69 | 05 - | D4BH | 4 | █ | Y-722JS | 9974 | | | |
| Magentis | 2.0 | 100 | 01 - 05 | | 4 | 0,8 | BPR6ES | 7822 | 2 | LPG 2 | 1497 |
| Magentis | 2.0 | 106 | 06 - 09 | G4KA | 4 | 1,1 | BKR5ES-11 | 2382 | 33 | LPG 1 | 1496 |
| Magentis V6 | 2.5 | 118 | 01 - | G6BV | 6 | 0,8 | BKR5ES | 2460 | 35 | LPG 1 | 1496 |
| Magentis V6 | 2.5 | 124 | 03 - | G6BV | 6 | 0,8 | BKR5ES | 2460 | 35 | LPG 1 | 1496 |
| Magentis V6 | 2.7 | 138 | 06 - 09 | G6EA | 6 | 1,1 | ILFR5B11 | 1637 | | ILFR6B | 6481 |
| Magentis CRDi | 2.0 | 103 | 04.06 - 09 | D4EA | 4 | █ | Y-749J | 5013 | | | |
| Mentor | 1.5 | | - 00 | B5 | 4 | 1,1 | BPR5ES-11 | 4424 | | LPG 2 | 1497 |
| Mentor | 1.6 | | 06.94 - 12.00 | | 4 | 1,1 | BPR5ES-11 | 4424 | | LPG 2 | 1497 |
| Mentor | 1.6 | | 01 - | A6 | 4 | 0,9 | BKR6E | 6962 | 28 | LPG 1 | 1496 |
| Opirus | 3.8 | | 07 - | G6DA | 6 | 1,1 | IFR5G11 | 7854 | | | |
| Opirus GH | 3.5 | 149 | 03 - 06 | | 6 | 1,1 | PFR5N-11 | 5838 | | PFR5N-11 | 5838 |
| Picanto | 1.0 | 45 | 05.04 - | G4HE | 4 | 1,1 | BKR6ES-11 | 5553 | 14 | LPG 1 | 1496 |
| Picanto | 1.1 | 48 | 10.03 - | G4HG | 4 | 1,1 | BKR5ES-11 | 2382 | 33 | LPG 1 | 1496 |
| Power Bango | 2.4 | | | E-2400 | 4 | █ | Y-107R | 1229 | | | |
| Pregio | 2.7 | 60 | 06.96 - | J2 | 4 | █ | Y-701J | 1566 | | D-POWER 39 | 1566 |
| Pregio | 3.0 | 66 | 06.97 - | W3 / NB9 | 4 | █ | Y-701J | 1566 | | D-POWER 39 | 1566 |
| Pride | 1.3 | 44 | 05.95 - 01 | | 4 | 1,1 | BPR5ES-11 | 4424 | | LPG 2 | 1497 |
| Pride | 1.3 | 53 | 05.95 - 01 | | 4 | 1,1 | BPR5ES-11 | 4424 | | LPG 2 | 1497 |
| Retona | 2.0 | 61 | 04.00 - | | 4 | █ | Y-721J | 6919 | | | |
| Retona 16V | 2.0 | 94 | 00 - | FED | 4 | 1,1 | BKR6E-11 | 2756 | 14 | LPG 1 | 1496 |
| Rio | 1.3 | 55 | 00 - 02 | | 4 | 1,1 | BPR5EY-11 | 3028 | | LPG 2 | 1497 |
| Rio | 1.3 | 60 | 03 - | | 4 | 1,1 | BPR5ES-11 | 4424 | | LPG 2 | 1497 |
| Rio | 1.4 | 71 | 06.05 - | | 4 | 1,1 | BKR5ES-11 | 2382 | 33 | LPG 1 | 1496 |
| Rio | 1.5 | 71 | 03 - | | 4 | 1,1 | BKR6ES-11 | 5553 | 14 | LPG 1 | 1496 |
| Rio | 1.5 | 72 | 00 - 02 | | 4 | 0,9 | BKR6E | 6962 | 28 | LPG 1 | 1496 |
| Rio | 1.6 | 82 | 06.05 - | CWT | 4 | 1,1 | BKR5ES-11 | 2382 | 33 | LPG 1 | 1496 |
| Roadster | 1.8 | 103 | 98 - | T8 DOHC | 4 | 0,8 | BK6E | 3536 | | LPG 1 | 1496 |
| Rockstar | 1.8 | | | SOHC | 4 | 0,7 | BP6ES | 7811 | 4 | LPG 2 | 1497 |
| Sedona | 2.5 | | 09.99 - | KV6 | 6 | 1,1 | PFR6N-11 | 3546 | | LPG 1 | 1496 |
| Sephia | 1.5 | 59 | 96 - | B5E MMO | 4 | 1,1 | BPR5ES-11 | 4424 | | LPG 2 | 1497 |
| Sephia | 1.8 | | 06.96 - | | 4 | 0,8 | BKR5E | 7938 | 35 | LPG 1 | 1496 |
| Sephia 2 FB522 | 1.6 | 75 | 04.01 - | OKAB5 | 4 | 0,9 | BKR6E | 6962 | 28 | LPG 1 | 1496 |
| Sephia GTX | 1.6 | 59 | 09.93 - | B6 SOHC | 4 | 1,1 | BPR6ES-11 | 4824 | 13 | LPG 2 | 1497 |
| Shuma 1 | 1.5 | 65 | 05.98 - | BFD | 4 | 1,1 | BKR6E-11 | 2756 | 14 | LPG 1 | 1496 |
| Shuma 1 | 1.8 | 82 | 05.98 - | TED | 4 | 0,9 | BKR6E | 6962 | 28 | LPG 1 | 1496 |
| Shuma 2 | 1.8 | 82 | 01 - | TED | 4 | 0,9 | BKR6E | 6962 | 28 | LPG 1 | 1496 |
| Shuma 2 FB522,FB624 | 1.6 | 75 | 04.01 - | OKAB5 | 4 | 0,9 | BKR6E | 6962 | 28 | LPG 1 | 1496 |
| Sorento (JC) | 3.3 | 177 | 06 - | G6DB | 6 | 1,1 | IFR5G11 | 7854 | | | |
| Sorento (JC) | 3.5 | 143 | 02 - | G6CU | 6 | 1,1 | PFR5N-11 | 5838 | | PFR5N-11 | 5838 |
| Sorento (JC) | 3.8 | | 06 - | G6DA | 6 | 1,1 | IFR5G11 | 7854 | | | |
| Sorento (XM) | 2.4 | | 10 - | G4KE | 4 | 1,1 | LFR5A-11 | 6376 | | LPG 7 | 1640 |



ℓ kW



Cyl.

Order-
No. No.LPG/CNG
D-PowerOrder-
No.**KIA**

| | | | | | | | | | | | |
|-------------------|-----|-----|---------------|--------------|---|-----|-----------|------|----|------------|------|
| Sorento CRDi (JC) | 2.5 | 103 | 08.02 - | | 4 | █ | Y-508J | 3709 | | | |
| Sorento (JC) | 2.4 | 75 | 02 - | G4JF | 4 | 1,1 | PGR5C-11 | 5760 | | PGR5C-11 | 5760 |
| Sportage | 2.0 | 70 | 94 - 12.02 | SOHC | 4 | 0,8 | BKR5E | 7938 | 35 | LPG 1 | 1496 |
| Sportage | 2.0 | 83 | 11.04 - | D4EA | 4 | █ | Y-749J | 5013 | | | |
| Sportage | 2.5 | 129 | 09.04 - | | 6 | 1,1 | BKR5ES-11 | 2382 | 33 | LPG 1 | 1496 |
| Sportage 16V | 2.0 | 94 | 94 - 08.04 | DOHC 16V | 4 | 1,1 | BKR6E-11 | 2756 | 14 | LPG 1 | 1496 |
| Sportage 2.0 | 2.0 | 104 | 06 - | G4GC | 4 | 1,1 | BKR5ES-11 | 2382 | 33 | LPG 1 | 1496 |
| Sportage 2.0 CRDi | 2.0 | 103 | 06 - | D4EA | 4 | █ | Y-749J | 5013 | | | |
| Sportage 2.7 | 2.7 | 129 | 06 - | G6BA V6 | 6 | 1,1 | PFR5N-11 | 5838 | | PFR5N-11 | 5838 |
| Sportage Tci | 2.2 | | | | | █ | Y-701J | 1566 | | D-POWER 39 | 1566 |
| Sportage TD | 2.0 | 61 | 07.96 - 08.99 | Mazda engine | 4 | █ | Y-701J | 1566 | | D-POWER 39 | 1566 |
| Super Titan | 3.0 | | | E-3000 | 6 | █ | Y-107T | 1253 | | | |
| Titan | 2.5 | | | E-2500 | 4 | █ | Y-107T | 1253 | | | |
| Titan | 2.7 | | | E-2700 | 4 | █ | Y-107T | 1253 | | | |
| Tropic | 2.7 | | | E-2700 | 4 | █ | Y-107T | 1253 | | | |
| Wide Bongo | 2.2 | | | LPG engine | 4 | 0,7 | BP6ES | 7811 | 4 | LPG 2 | 1497 |

LADA (AVTOVAZ)

| | | | | | | | | | | | |
|---|------|-----|---------------|------------|---|-----|------------|------|----|-------|------|
| 110 2.0 GTI | 2.0 | 110 | 01.00 - | C20XE | 4 | | BKR6EK | 2288 | 20 | LPG 1 | 1496 |
| 1111 Oka / 640 | 0.65 | 22 | 09.89 - | BA3 1111 | 2 | 0,7 | BCP6ES | 4930 | 17 | LPG 3 | 1498 |
| 1111 Oka 1.3 | 1.3 | 46 | 01.98 - | A-Plus ROV | 4 | 0,8 | BPR6ES | 7822 | 2 | LPG 2 | 1497 |
| 112 2112 16V | 1.5 | 54 | 01.96 - | VAZ-2111 | 4 | 0,8 | BPR6ES | 7822 | 2 | LPG 2 | 1497 |
| 112 Gli | 1.5 | 67 | 03 - | 16V | 4 | 1,1 | BCPR6ES-11 | 7121 | 11 | LPG 3 | 1498 |
| 1200 | 1.2 | | | | 4 | 0,8 | BP5ES | 6511 | 8 | LPG 2 | 1497 |
| 2101, 21011, 21012, 21013, 21014 1.2-1.5 ltr | | 44 | | | 4 | 0,7 | BP6ES | 7811 | 4 | LPG 2 | 1497 |
| 2102, 21021, 21022, 21023, 21024, 21026 Lada Kombi | 1.2 | 43 | | BA3 2101 | 4 | 0,7 | BP6ES | 7811 | 4 | LPG 2 | 1497 |
| 2102, 21021, 21022, 21023, 21024, 21026 Lada Kombi | 1.3 | 47 | | BA3 21011 | 4 | 0,7 | BP6ES | 7811 | 4 | LPG 2 | 1497 |
| 21040 / Nova Kombi | 1.3 | 46 | 01.84 - 06.88 | BA3 21011 | 4 | 0,7 | BP6ES | 7811 | 4 | LPG 2 | 1497 |
| 21043 / Nova Kombi | 1.5 | 53 | 01.88 - | BA3-2103 | 4 | 0,7 | BP6ES | 7811 | 4 | LPG 2 | 1497 |
| 2105 Nova 1300 | 1.3 | | | | 4 | 0,7 | BP6ES | 7811 | 4 | LPG 2 | 1497 |
| 2105 Nova Junior | 1.2 | | | | 4 | 0,7 | BP6ES | 7811 | 4 | LPG 2 | 1497 |
| 2105 Nova Spezial | 1.5 | | | | 4 | 0,7 | BP6ES | 7811 | 4 | LPG 2 | 1497 |
| 21050 | 1.5 | 53 | 01.88 - | BA3 21011 | 4 | 0,7 | BP6ES | 7811 | 4 | LPG 2 | 1497 |
| 21051 | 1.2 | 43 | 01.80 - 06.88 | BA3 2101 | 4 | 0,7 | BP6ES | 7811 | 4 | LPG 2 | 1497 |
| 21060 | 1.3 | 47 | | BA3 21011 | 4 | 0,7 | BP6ES | 7811 | 4 | LPG 2 | 1497 |
| 21063 | 1.5 | 52 | | BA3 2103 | 4 | 0,7 | BP6ES | 7811 | 4 | LPG 2 | 1497 |
| 2107 Lada 1300 L | 1.3 | | | | 4 | 0,7 | BP6ES | 7811 | 4 | LPG 2 | 1497 |
| 2107 Lada 1500 L | 1.5 | | | | 4 | 0,7 | BP6ES | 7811 | 4 | LPG 2 | 1497 |
| 2107 Toscana | 1.5 | 55 | 07.88 - | | 4 | 0,7 | BP6ES | 7811 | 4 | LPG 2 | 1497 |
| 21070 | 1.3 | 47 | 01.82 - | BA3 21011 | 4 | 0,7 | BP6ES | 7811 | 4 | LPG 2 | 1497 |
| 21073 | 1.5 | 53 | 01.88 - | BA3 2103 | 4 | 0,7 | BP6ES | 7811 | 4 | LPG 2 | 1497 |
| 2108 Samara / Fun 1100 | 1.1 | | | | 4 | 0,7 | BP6ES | 7811 | 4 | LPG 2 | 1497 |
| 2108 Samara / Fun 1300 | 1.3 | | | | 4 | 0,7 | BP6ES | 7811 | 4 | LPG 2 | 1497 |
| 2108 Samara / Fun 1500 | 1.5 | | | | 4 | 0,7 | BP6ES | 7811 | 4 | LPG 2 | 1497 |
| 21080 Samara 1.3 | 1.3 | 48 | 01.84 - | | 4 | 0,8 | BPR6ES | 7822 | 2 | LPG 2 | 1497 |
| 21081 / Fun 1100 | 1.1 | 39 | 01.84 - | | 4 | 0,8 | BPR6ES | 7822 | 2 | LPG 2 | 1497 |
| 21083 / Fun 1500 | 1.5 | 53 | 01.84 - | BA3 2103 | 4 | 0,8 | BPR6ES | 7822 | 2 | LPG 2 | 1497 |
| 21083 i | 1.5 | 57 | | BA3 2111 | 4 | 1,1 | BPR6ES-11 | 4824 | 13 | LPG 2 | 1497 |
| 21090 | 1.3 | 48 | 01.87 - | BA3 2108 | 4 | 0,8 | BPR6ES | 7822 | 2 | LPG 2 | 1497 |



ℓ kW



Cyl.

Order-
No.VLINE
No.LPG/CNG
D-PowerOrder-
No.**LADA (AVTOVAZ)**

| | | | | | | | | | | | |
|---|-----|-----|---------|---------------|---|-----|------------|------|----|-----------|------|
| 21091 | 1.1 | 39 | 01.87 - | | 4 | 0,8 | BPR6ES | 7822 | 2 | LPG 2 | 1497 |
| 21093 | 1.5 | 53 | 01.87 - | BA3 2103 | 4 | 0,8 | BPR6ES | 7822 | 2 | LPG 2 | 1497 |
| 21093 i | 1.5 | 57 | | BA3 2111 | 4 | 1,1 | BPR6ES-11 | 4824 | 13 | LPG 2 | 1497 |
| 21099 | 1.3 | 48 | 01.90 - | BA3 2108 | 4 | 0,8 | BPR6ES | 7822 | 2 | LPG 2 | 1497 |
| 210993 Samara 1.5 | 1.5 | 53 | 01.90 - | | 4 | 0,8 | BPR6ES | 7822 | 2 | LPG 2 | 1497 |
| 210993 Samara 1.5i | 1.5 | 57 | | VAZ-2111 | 4 | 1,1 | BPR6ES-11 | 4824 | 13 | LPG 2 | 1497 |
| 2110 | 1.5 | 56 | 96 - | | 4 | 0,8 | BPR6ES | 7822 | 2 | LPG 2 | 1497 |
| 2110 | 1.5 | 58 | 97 - | | 4 | 0,8 | BPR6ES | 7822 | 2 | LPG 2 | 1497 |
| 2110 GTi 16V | 2.0 | 110 | 01.96 - | C20XE Opel | 4 | 0,9 | BKR6E | 6962 | 28 | LPG 1 | 1496 |
| 2110 1,5 | 1.5 | 53 | 06.96 - | | 4 | 0,8 | BPR6ES | 7822 | 2 | LPG 2 | 1497 |
| 21102 i | 1.5 | 57 | 01.96 - | BA3 2111 | 4 | 1,1 | BPR6ES-11 | 4824 | 13 | LPG 2 | 1497 |
| 21103 16V | 1.5 | 67 | 01.96 - | BA3 2112 | 4 | 1,1 | BCPR6ES-11 | 7121 | 11 | LPG 3 | 1498 |
| 2111 | 1.5 | 58 | 97 - | | 4 | 0,8 | BPR6ES | 7822 | 2 | LPG 2 | 1497 |
| 21110 i | 1.5 | 57 | 01.98 - | BA3 2111 | 4 | 1,1 | BPR6ES-11 | 4824 | 13 | LPG 2 | 1497 |
| 21111 | 1.5 | 53 | 01.98 - | BA3 2120 | 4 | 0,8 | BPR6ES | 7822 | 2 | LPG 2 | 1497 |
| 21113 16V | 1.5 | 67 | 01.98 - | BA3 2112 | 4 | 1,1 | BCPR6ES-11 | 7121 | 11 | LPG 3 | 1498 |
| 21120 16V | 1.5 | 67 | 01.00 - | VAZ-2112 | 4 | 1,1 | BCPR6ES-11 | 7121 | 11 | LPG 3 | 1498 |
| 21122 i | 1.5 | 57 | 01.00 - | VAZ-2111 | 4 | 1,1 | BPR6ES-11 | 4824 | 13 | LPG 2 | 1497 |
| 2114 i | 1.5 | 57 | 01.01 - | BA3 2111 | 4 | 1,1 | BPR6ES-11 | 4824 | 13 | LPG 2 | 1497 |
| 2115 1,5 | 1.5 | 53 | 00.00 - | | 4 | 0,8 | BPR6ES | 7822 | 2 | LPG 2 | 1497 |
| 2115 1,5i | 1.5 | 57 | 01.00 - | VAZ-2111 | 4 | 1,1 | BPR6ES-11 | 4824 | 13 | LPG 2 | 1497 |
| 2120 Nadeschda 1,7i | 1.7 | 60 | 01.98 - | BA3-21214 | 4 | 1,1 | BPR6ES-11 | 4824 | 13 | LPG 2 | 1497 |
| 2120 Nadeschda 1,8 | 1.8 | 59 | 01.98 - | BA3-2130 | 4 | 0,8 | BPR6ES | 7822 | 2 | LPG 2 | 1497 |
| 21213 Niva 1.7 | 1.7 | 55 | 01.93 - | | 4 | 0,8 | BPR6ES | 7822 | 2 | LPG 2 | 1497 |
| 21214 Niva 1.7i | 1.7 | 60 | 01.01 - | BA3-21214 | 4 | 1,1 | BPR6ES-11 | 4824 | 13 | LPG 2 | 1497 |
| 21310 Niva 1.7i | 1.7 | 60 | 01.95 - | BA3-21214 | 4 | 1,1 | BPR6ES-11 | 4824 | 13 | LPG 2 | 1497 |
| 21312 Niva 1.8 | 1.8 | 59 | 01.95 - | BA3-2130 | 4 | 0,8 | BPR6ES | 7822 | 2 | LPG 2 | 1497 |
| Aleko D | 1.8 | 44 | | Ford RTE, RTS | 4 | █ | Y-910R | 4751 | | D-POWER 3 | 3617 |
| Aleko D | 1.8 | 44 | 01.87 - | Ford RTE, RTS | 4 | █ | Y-910R | 4751 | | D-POWER 3 | 3617 |
| Forma | 1.3 | | 09.91 - | | 4 | 0,8 | BPR6ES | 7822 | 2 | LPG 2 | 1497 |
| Forma | 1.5 | 50 | 09.91 - | | 4 | 0,8 | BPR6ES | 7822 | 2 | LPG 2 | 1497 |
| Forma 21099 | 1.5 | 56 | | | 4 | 0,8 | BPR6ES | 7822 | 2 | LPG 2 | 1497 |
| Lada 110 21101 8V | 1.6 | 59 | 04 - | 21114 | 4 | 1,1 | BPR6ES-11 | 4824 | 13 | LPG 2 | 1497 |
| Lada 110 21104 | 1.6 | 66 | 04 - | 21124 | 4 | 1,1 | BCPR6ES-11 | 7121 | 11 | LPG 3 | 1498 |
| Lada 111 21112 8V | 1.6 | 59 | 04 - | 21114 | 4 | 1,1 | BPR6ES-11 | 4824 | 13 | LPG 2 | 1497 |
| Lada 111 21114 16V | 1.6 | 66 | 04 - | 21124 | 4 | 1,1 | BCPR6ES-11 | 7121 | 11 | LPG 3 | 1498 |
| Lada 112 21121 8V | 1.6 | 59 | 04 - | 21114 | 4 | 1,1 | BPR6ES-11 | 4824 | 13 | LPG 2 | 1497 |
| Lada 112 21124 16V | 1.6 | 66 | 04 - | 21124 | 4 | 1,1 | BCPR6ES-11 | 7121 | 11 | LPG 3 | 1498 |
| Lada 2101/ 21011/ 21012/ 21013/ 21014 | | | | | 4 | 0,7 | BP6ES | 7811 | 4 | LPG 2 | 1497 |
| Lada 2102/ 21021/ 21022/ 21023/ 21024/ 21026 | | | | | 4 | 0,7 | BP6ES | 7811 | 4 | LPG 2 | 1497 |
| Lada 2103/ 21033/ 21035 | | | | | 4 | 0,7 | BP6ES | 7811 | 4 | LPG 2 | 1497 |
| Lada 2104/ 21043/ 21046/ 21047 | | | | | 4 | 0,7 | BP6ES | 7811 | 4 | LPG 2 | 1497 |
| Lada 2105/ 21051/ 21053/ 21056/ 21057 | | | | | 4 | 0,7 | BP6ES | 7811 | 4 | LPG 2 | 1497 |
| Lada 2106/ 21061/ 21064/ 21065-01/ 21066 | | | | | 4 | 0,7 | BP6ES | 7811 | 4 | LPG 2 | 1497 |
| Lada 2107/ 21072/ 21073/ 21074/ 21076/ 21077/ 21078/ 210736-40 | | | | | 4 | 0,7 | BP6ES | 7811 | 4 | LPG 2 | 1497 |
| Lada 2108/ 21081/ 21083/ 21087/ 21088 | | | | | 4 | 0,8 | BPR6ES | 7822 | 2 | LPG 2 | 1497 |



l kW

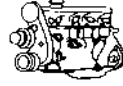

Cyl.

Order-
No. No.LPG/CNG
D-PowerOrder-
No.**LADA (AVTOVAZ)**

| | | | | | | | | | | | |
|--|------|----|--------------|----------------|---|-----|------------|------|----|------------|------|
| Lada 21083i/ 21093i/ 21099i/ 21102/ 211026/ 21110/ 2131i | | | | | 4 | 1,1 | BPR6ES-11 | 4824 | 13 | LPG 2 | 1497 |
| Lada 2109/ 21091/ 21093 | | | | | 4 | 0,8 | BPR6ES | 7822 | 2 | LPG 2 | 1497 |
| Lada 21099 | | | | | 4 | 0,8 | BPR6ES | 7822 | 2 | LPG 2 | 1497 |
| Lada 2110/ 2111 | | | | | 4 | 0,8 | BPR6ES | 7822 | 2 | LPG 2 | 1497 |
| Lada 21103/ 211036/ 21113/ 21109/ 21108/ 21083-37/ 2112/ 2113/ 21103 | | | | | 4 | 1,1 | BCPR6ES-11 | 7121 | 11 | LPG 3 | 1498 |
| Lada 2115-01/ 2115-03/ 21153-01 | | | | | 4 | 0,8 | BPR6ES | 7822 | 2 | LPG 2 | 1497 |
| Lada 2115-20/ 2115-21/ 2115-23/ 21153-21 | | | | | 4 | 1,1 | BPR6ES-11 | 4824 | 13 | LPG 2 | 1497 |
| Lada Kalina 1117 | 1.6 | 58 | 10.04- | BA3 11183 | 4 | 1,1 | BCPR6ES-11 | 7121 | 11 | LPG 3 | 1498 |
| Lada Kalina 1117 8V | 1.6 | 59 | 05- | 21114 | 4 | 1,1 | BPR6ES-11 | 4824 | 13 | LPG 2 | 1497 |
| Lada Kalina 1118 | 1.6 | 58 | 10.04- | BA3 11183 | 4 | 1,1 | BCPR6ES-11 | 7121 | 11 | LPG 3 | 1498 |
| Lada Kalina 1118 8V | 1.6 | 59 | 05- | 21114 | 4 | 1,1 | BPR6ES-11 | 4824 | 13 | LPG 2 | 1497 |
| Lada Kalina 1119 | 1.6 | 58 | 10.04- | BA3 11183 | 4 | 1,1 | BCPR6ES-11 | 7121 | 11 | LPG 3 | 1498 |
| Lada Kalina 1119 8V | 1.6 | 59 | 05- | 21114 | 4 | 1,1 | BPR6ES-11 | 4824 | 13 | LPG 2 | 1497 |
| Lada Kalina 1117 16V | 1.6 | 65 | 10.04- | BA3 21124 | 4 | 1,1 | BCPR6ES-11 | 7121 | 11 | LPG 3 | 1498 |
| Lada Kalina 1118 16V | 1.6 | 65 | 10.04- | BA3 21124 | 4 | 1,1 | BCPR6ES-11 | 7121 | 11 | LPG 3 | 1498 |
| Lada Kalina 1119 16V | 1.6 | 65 | 10.04- | BA3 21124 | 4 | 1,1 | BCPR6ES-11 | 7121 | 11 | LPG 3 | 1498 |
| Lada Niva 2129 1.7 Niva | 1.7 | 59 | 93- | 21213 | 4 | 0,8 | BPR6ES | 7822 | 2 | LPG 2 | 1497 |
| Lada NIVA 4x4 2121 | | | | | 4 | 0,7 | BP6ES | 7811 | 4 | LPG 2 | 1497 |
| Lada NIVA 4x4 21211/ 21212 | | | | | 4 | 0,8 | BPR6ES | 7822 | 2 | LPG 2 | 1497 |
| Lada NIVA 4x4 2131/ 2130/ 2129/ 21217/ 21214/ 21213 | | | | | 4 | 0,8 | BPR6ES | 7822 | 2 | LPG 2 | 1497 |
| Lada OKA 1111/ 1113 | | | | | 4 | 0,7 | BCP6ES | 4930 | 17 | LPG 3 | 1498 |
| Lada Samara 2113 8V | 1.5 | 56 | 04- | 2111 | 4 | 1,1 | BPR6ES-11 | 4824 | 13 | LPG 2 | 1497 |
| Niva | 1.7 | 59 | 95- | | 4 | 0,8 | BPR6ES | 7822 | 2 | LPG 2 | 1497 |
| Niva D | 1.9 | 47 | 10.93- | Peugeot XUD 9L | 4 | █ | Y-924J | 7906 | | D-POWER 1 | 7906 |
| Nova / Vaz 2102, 2105 | 1.3 | 48 | 05.81 -06.88 | | 4 | 0,7 | BP6ES | 7811 | 4 | LPG 2 | 1497 |
| Nova / Vaz 2102, 2105 | 1.3 | 48 | 07.88- | | 4 | 0,8 | BPR6ES | 7822 | 2 | LPG 2 | 1497 |
| Nova / Vaz 2104, 2105 | | 55 | 07.88- | | 4 | 0,8 | BPR6ES | 7822 | 2 | LPG 2 | 1497 |
| Nova / Vaz 2104, 2105 | | 55 | 09.86 -06.88 | | 4 | 0,7 | BP6ES | 7811 | 4 | LPG 2 | 1497 |
| Nova / Vaz 21043 | 1.5 | 55 | 01.88 -06.88 | | 4 | 0,7 | BP6ES | 7811 | 4 | LPG 2 | 1497 |
| Nova / Vaz 21043 | 1.5 | 55 | 07.88- | | 4 | 0,8 | BPR6ES | 7822 | 2 | LPG 2 | 1497 |
| Nova / Vaz 21051 | 1.2 | 44 | 07.88- | | 4 | 0,8 | BPR6ES | 7822 | 2 | LPG 2 | 1497 |
| Nova / Vaz 21051 | 1.2 | 44 | 09.81 -06.88 | | 4 | 0,7 | BP6ES | 7811 | 4 | LPG 2 | 1497 |
| Nova / Vaz 2107 | | 57 | 05.81 -06.88 | | 4 | 0,7 | BP6ES | 7811 | 4 | LPG 2 | 1497 |
| Nova / Vaz 2107 | | 57 | 07.88- | | 4 | 0,8 | BPR6ES | 7822 | 2 | LPG 2 | 1497 |
| Nova i | 1.7 | 59 | 11.94- | | 4 | 0,8 | BPR6ES | 7822 | 2 | LPG 2 | 1497 |
| Nova i | 1.7 | 62 | 11.94- | | 4 | 0,8 | BPR6ES | 7822 | 2 | LPG 2 | 1497 |
| OkA /640 | 0.65 | 22 | 09.89- | Vaz 1111 | 2 | 0,7 | BCP6ES | 4930 | 17 | LPG 3 | 1498 |
| OkA 1.3 VAZ-1111 | 1.3 | 46 | 01.98- | A-Plus ROV | 4 | 0,8 | BPR6ES | 7822 | 2 | LPG 2 | 1497 |
| Riva 1200 | 1.2 | 47 | 11.85- | OHC 21012 | 4 | 0,7 | BP6ES | 7811 | 4 | LPG 2 | 1497 |
| Riva 1300 | 1.3 | 49 | 11.85- | OHC 21056 | 4 | 0,7 | BP6ES | 7811 | 4 | LPG 2 | 1497 |
| Riva 1500 | 1.5 | 55 | 11.85- | OHC 21026 | 4 | 0,7 | BP6ES | 7811 | 4 | LPG 2 | 1497 |
| Riva 1600 | 1.6 | 63 | 01.86- | OHC 21062 | 4 | 0,7 | BP6ES | 7811 | 4 | LPG 2 | 1497 |
| Sagona D | 1.5 | 40 | 01.95- | TUD5 | 4 | █ | Y-503J | 1009 | | D-POWER 10 | 1009 |
| Sagona GLX | 1.5 | | 07.95- | | 4 | 0,8 | BPR6ES | 7822 | 2 | LPG 2 | 1497 |
| Sagona i | 1.5 | | 07.94- | | 4 | 0,9 | BPR5ES | 7422 | 6 | LPG 2 | 1497 |
| Samara / Vaz 2108 | 1.1 | 41 | 07.88- | | 4 | 0,8 | BPR6ES | 7822 | 2 | LPG 2 | 1497 |
| Samara / Vaz 2108 | 1.1 | 41 | 08.86 -06.88 | | 4 | 0,7 | BP6ES | 7811 | 4 | LPG 2 | 1497 |



ℓ kW

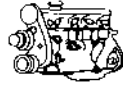

Cyl.

Order-
No.VLINE
No.LPG/CNG
D-PowerOrder-
No.**LADA (AVTOVAZ)**

| | | | | | | | | | | | |
|-------------------|-----|----|-------------|-------|---|-----|--------|------|---|------------|------|
| Samara / Vaz 2108 | 1.3 | 46 | 01.88-06.88 | | 4 | 0,7 | BP6ES | 7811 | 4 | LPG 2 | 1497 |
| Samara / Vaz 2108 | 1.3 | 46 | 07.88- | | 4 | 0,8 | BPR6ES | 7822 | 2 | LPG 2 | 1497 |
| Samara 21093 | 1.5 | 56 | | | 4 | 0,8 | BPR6ES | 7822 | 2 | LPG 2 | 1497 |
| Samara D | 1.5 | 40 | 01.95- | TUD 5 | 4 | █ | Y-503J | 1009 | | D-POWER 10 | 1009 |
| Samara Fun | 1.1 | 39 | 09.91- | | 4 | 0,8 | BPR6ES | 7822 | 2 | LPG 2 | 1497 |
| Samara Sport | 1.5 | 65 | 96- | | 4 | 0,8 | BPR6ES | 7822 | 2 | LPG 2 | 1497 |
| Toscana | 1.5 | 55 | 01.86- | | 4 | 0,7 | BP6ES | 7811 | 4 | LPG 2 | 1497 |

LAMBORGHINI

| | | | | | | | | | | | |
|-----------------------------------|-----|-----|--------|------|----|-----|--------|------|--|---------|------|
| Gallardo Coupé | 5.0 | 382 | 05.05- | L140 | 10 | 0,8 | PFR7G | 4364 | | PFR7G | 4364 |
| Gallardo Coupé Superleggera | 5.0 | 390 | 06.07- | L140 | 10 | 0,8 | PFR7G | 4364 | | PFR7G | 4364 |
| Gallardo Spider | 5.0 | 382 | 05.05- | L140 | 10 | 0,8 | PFR7G | 4364 | | PFR7G | 4364 |
| LP 500 S V12 | | | 82- 85 | | 12 | 0,6 | BP8EVX | 2671 | | BPR9EIX | 6853 |
| Murciélago Coupé | 6.5 | 471 | 04.06- | L537 | 12 | | KR8BI | 4347 | | KR8BI | 4347 |
| Murciélago LP640 Coupe / Roadster | 6.5 | 471 | 07- | L537 | 12 | | KR8BI | 4347 | | KR8BI | 4347 |

LANCIA

| | | | | | | | | | | | |
|------------------------------------|-----|-----|-------------|-------------------|---|-----|---------|------|----|------------|------|
| A112 | 0.9 | 30 | 03.84-12.86 | A112B... | 4 | 0,8 | BPR6ES | 7822 | 2 | LPG 2 | 1497 |
| Dedra 1.6 | 1.6 | 66 | 03.97-02.98 | 159B9.000 | 4 | 0,9 | BCPR7ES | 3330 | | BCPR7EIX | 5690 |
| Dedra 1.6i.e. S.W. 16V | 1.6 | 76 | 03.98-01.00 | 182A4.000 | 4 | 0,9 | BKR5EZ | 7642 | 36 | LPG 1 | 1496 |
| Dedra 1.8- 16V | 1.8 | 83 | 07.97-01.00 | 182A2.000 | 4 | | BKR6EKC | 2848 | 26 | LPG 1 | 1496 |
| Dedra 1.6i.e. 16V | 1.6 | 76 | 03.98-01.00 | 182A4.000 | 4 | 0,9 | BKR5EZ | 7642 | 36 | LPG 1 | 1496 |
| Dedra 1.6L - LE/S.W. LE | 1.6 | 66 | 10.94-02.98 | 159B9.000 | 4 | 0,9 | BCPR7ES | 3330 | | BCPR7EIX | 5690 |
| Dedra 1.6L i.e. | 1.6 | 57 | 08.89-09.94 | 835A1.046 Cat. | 4 | 0,8 | BPR6ES | 7822 | 2 | LPG 2 | 1497 |
| Dedra 1.8L - LE-LS-SW | 1.8 | 74 | 10.94-02.98 | 835A2.046 | 4 | 0,9 | BCPR7ES | 3330 | | BCPR7EIX | 5690 |
| Dedra 2.0L-16V- S.W.LX / integrale | 2.0 | 102 | 10.94-02.98 | 836A3.000 | 4 | 0,8 | BPR7ES | 2023 | 19 | BPR8EIX | 6684 |
| Dedra 2000 Turbo | 2.0 | 119 | 08.91-02.98 | 835A8.046 | 4 | | BP6ET | 1263 | | LPG 2 | 1497 |
| Dedra Eco LE TD | 1.9 | 68 | 06.93- | 160 D 1.000 | 4 | █ | Y-922R | 4356 | | D-POWER 1 | 7906 |
| Dedra i.e. / LS | 2.0 | 83 | 01.89-09.94 | 835A5.046 Cat. | 4 | 0,8 | BPR7ES | 2023 | 19 | BPR8EIX | 6684 |
| Dedra i.e. automatica LS | 2.0 | 83 | 10.94-04.97 | 835A5.046 | 4 | 0,8 | BPR7ES | 2023 | 19 | BPR8EIX | 6684 |
| Dedra i.e. Turbo/Integr. | 2.0 | 124 | 01.91-09.94 | 835A7.046 Cat. | 4 | | BP6ET | 1263 | | LPG 2 | 1497 |
| Dedra i.e./ LE | 1.8 | 77 | 01.89-09.94 | 835A2.046 Cat. | 4 | 0,8 | BPR7ES | 2023 | 19 | BPR8EIX | 6684 |
| Dedra TD | 1.9 | 66 | 03.89-09.94 | 835 A 4.000 | 4 | █ | Y-924J | 7906 | | D-POWER 1 | 7906 |
| Dedra TD ds | 1.9 | 66 | 10.94- | 160 D 1.000 | 4 | █ | Y-922R | 4356 | | D-POWER 1 | 7906 |
| Delta | 1.6 | 55 | 09.93-11.97 | 851C1.000 | 4 | 0,9 | BCPR7ES | 3330 | | BCPR7EIX | 5690 |
| Delta | 1.6 | 76 | 03.98-01.00 | 182A4.000 | 4 | 0,9 | BKR5EZ | 7642 | 36 | LPG 1 | 1496 |
| Delta (836) | 1.6 | 66 | 03.96-02.98 | 182A6.000 | 4 | 0,9 | BCPR7ES | 3330 | | BCPR7EIX | 5690 |
| Delta HPE Td | 1.9 | 66 | 10.96- | | 4 | █ | Y-928U | 4389 | | D-POWER 29 | 4389 |
| Delta / LX | 1.3 | 57 | - 93 | 831A...- 831B.000 | 4 | 0,8 | BPR7ES | 2023 | 19 | BPR8EIX | 6684 |
| Delta / LX / Automatic | 1.5 | 59 | - 93 | 831A...- 831B.000 | 4 | 0,8 | BPR7ES | 2023 | 19 | BPR8EIX | 6684 |
| DELTA 1.4 T-Jet 120 CV GPL | 1.4 | 88 | 10.09- | | 4 | 0,8 | IKR9F8 | 5756 | | IKR9F8 | 5756 |
| Delta 1.4 T-JET 120CV | 1.4 | 88 | 08- | 198A4000 | 4 | 0,8 | IKR9F8 | 5756 | | IKR9F8 | 5756 |
| Delta 1.4 T-JET 150CV | 1.4 | 110 | 08- | 198A1000 | 4 | 0,8 | IKR9F8 | 5756 | | IKR9F8 | 5756 |
| Delta 1.6i.e. 16V HPE; LS | 1.6 | 76 | 12.97-02.98 | 182A4.000 | 4 | | BKR6EKC | 2848 | 26 | LPG 1 | 1496 |
| Delta 1.8- 16V- HPE/LS | 1.8 | 96 | 12.97-01.00 | 183A1.000 | 4 | | BKR6EKC | 2848 | 26 | LPG 1 | 1496 |
| Delta 16V - HPE | 1.6 | 76 | 06.96-11.97 | 182A4.000 | 4 | | BKR6EKC | 2848 | 26 | LPG 1 | 1496 |
| Delta 16V/ HPE | 1.8 | 96 | 06.96-11.97 | 183A1.000 | 4 | | BKR6EKC | 2848 | 26 | LPG 1 | 1496 |
| Delta GT | 1.6 | 77 | - 93 | 831A4.000 | 4 | 0,8 | BPR7ES | 2023 | 19 | BPR8EIX | 6684 |
| Delta HF Integrale Evo 3 | 2.0 | 144 | 07.92-11.97 | 831C5.046 | 4 | | BP6ET | 1263 | | LPG 2 | 1497 |
| Delta HF integrale Spec.ed. | 2.0 | 155 | 02.94-11.97 | 831E5.046 | 4 | | BUR6ET | 3172 | 1 | LPG 2 | 1497 |
| Delta HPE ie | 2.0 | 102 | 06.95- | | 4 | 0,8 | BPR7ES | 2023 | 19 | BPR8EIX | 6684 |
| Delta HPE TD | 1.9 | 66 | 10.94- | 160 D 1.000 | 4 | █ | Y-922R | 4356 | | D-POWER 1 | 7906 |



ℓ kW

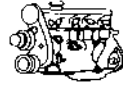

Cyl.

Order-
No. No.LPG/CNG
D-PowerOrder-
No.**LANCIA**

| | | | | | | | | | | | |
|------------------------------|-----|-----|---------------|----------------------|---|-----|---------|------|----|------------|------|
| Delta HPE Turbo 16V HF | 2.0 | 137 | 06.95 - | | 4 | | BUR6ET | 3172 | 1 | LPG 2 | 1497 |
| Delta i.e. 16V / LS | 2.0 | 102 | 09.93 - 11.97 | 836A3.000 | 4 | 0,8 | BPR7ES | 2023 | 19 | BPR8EIX | 6684 |
| Delta i.e. / LE | 1.8 | 66 | 09.93 - 11.97 | 835C4.000 | 4 | 0,8 | BPR7ES | 2023 | 19 | BPR8EIX | 6684 |
| Delta i.e. / Turbo HF | 1.6 | 95 | - 93 | 831A7.000 Cat. | 4 | 0,8 | BPR7ES | 2023 | 19 | BPR8EIX | 6684 |
| Delta i.e. 16V GT | 2.0 | 102 | 10.94 - 11.97 | 836A3.000 | 4 | 0,8 | BPR7ES | 2023 | 19 | BPR8EIX | 6684 |
| Delta i.e. GT | 1.6 | 77 | - 93 | 182A4.000 Cat. | 4 | 0,8 | BPR6ES | 7822 | 2 | LPG 2 | 1497 |
| Delta i.e. HPE Turbo 16V | 2.0 | 137 | 01.93 - 09.96 | 836 A2.000 | 4 | 0,8 | BPR7ES | 2023 | 19 | BPR8EIX | 6684 |
| Delta i.e. HPE Turbo 16V HF | 2.0 | 142 | 12.97 - 01.00 | 175A4.000 | 4 | | BCPR6ET | 2197 | | LPG 3 | 1498 |
| Delta i.e. Turbo HF 16V Inte | 2.0 | 122 | 05.86 - 09.87 | 831B5.000 | 4 | 0,8 | BPR7ES | 2023 | 19 | BPR8EIX | 6684 |
| Delta i.e. Turbo HF 16V Inte | 2.0 | 144 | 10.87 - 11.97 | 831 C5.000 | 4 | 0,8 | BPR7ES | 2023 | 19 | BPR8EIX | 6684 |
| Delta i.e. Turbo HF 4WD | 2.0 | | 05.86 - 09.87 | | 4 | 0,8 | BPR7ES | 2023 | 19 | BPR8EIX | 6684 |
| Delta i.e. Turbo HF Integr. | 2.0 | 144 | 07.92 - 11.97 | 831C5.046 | 4 | 0,8 | BPR7ES | 2023 | 19 | BPR8EIX | 6684 |
| Delta TD | 1.9 | 59 | 06.86 - 06.91 | 831 D 1.000 | 4 | ■ | Y-924J | 7906 | | D-POWER 1 | 7906 |
| Delta TD ds | 1.9 | 66 | 10.94 - | 160 D 1.000 | 4 | ■ | Y-922R | 4356 | | D-POWER 1 | 7906 |
| Delta TD- ds LE | 1.9 | 66 | 10.94 - | 160 D 1.000 | 4 | ■ | Y-922R | 4356 | | D-POWER 1 | 7906 |
| Delta TD LS | 1.9 | 66 | 10.94 - | 160 D 1.000 | 4 | ■ | Y-922R | 4356 | | D-POWER 1 | 7906 |
| Delta Turbo | 2.0 | 137 | 09.93 - 11.97 | 836 A2.000 | 4 | | BP6ET | 1263 | | LPG 2 | 1497 |
| Gamma i.e. / Coupe | 2.5 | 103 | 06.80 - 12.84 | 830AC0.A | 4 | 0,8 | BPR7ES | 2023 | 19 | BPR8EIX | 6684 |
| HPE | 1.6 | | | | 4 | 0,8 | BPR7ES | 2023 | 19 | BPR8EIX | 6684 |
| HPE i.e. | 2.0 | | | | 4 | 0,8 | BPR7ES | 2023 | 19 | BPR8EIX | 6684 |
| K | 2.0 | 114 | 11.94 - 02.01 | 838 A6.000 | 4 | | BKR6EKC | 2848 | 26 | LPG 1 | 1496 |
| K | 2.0 | 114 | 07.98 - 02.01 | 838A6.000 | 4 | | BCPR6ET | 2197 | | LPG 3 | 1498 |
| K 20V LS; S.W. | 2.0 | 114 | 07.98 - 02.01 | 838 A6.000 | 5 | | BKR6EKC | 2848 | 26 | LPG 1 | 1496 |
| K turbo | 2.0 | 151 | 02.95 - 06.98 | 838A4.000 | 4 | | BP6ET | 1263 | | LPG 2 | 1497 |
| K Turbo 16V Coupé | 2.0 | 151 | 07.97 - 06.98 | 838A4.000 | 4 | | BP6ET | 1263 | | LPG 2 | 1497 |
| K V6 - 24V-LX/LS/SW/coupè | 3.0 | 150 | 01.95 - 02.01 | 838B.000 | 6 | 0,9 | PFR6B | 3500 | | PFR7B | 4853 |
| K i 20V Coupé | 2.5 | 129 | 07.97 - 02.01 | 838A2.000 | 5 | | BKR6EKC | 2848 | 26 | LPG 1 | 1496 |
| K i V6 24V aut. Coupé | 3.0 | 150 | 07.97 - 02.01 | 838B.000 | 6 | 0,9 | PFR6B | 3500 | | PFR7B | 4853 |
| K i. 20V LS/LE/LX/SW | 2.4 | 129 | 01.95 - 02.01 | 838A2.000 | 5 | | BKR6EKC | 2848 | 26 | LPG 1 | 1496 |
| KAPPA / SW / Coupé 2,4 JTD | 2.4 | 100 | 11.99 - 04 | 838A8000 dal n. | 5 | ■ | Y-534J | 3413 | | D-POWER 36 | 3413 |
| | | | | motore 1713819 —> | | | | | | | |
| KAPPA / SW / Coupé 2,4 JTD | 2.4 | 100 | 06.98 - 10.99 | 838A8000 fino a n. | 5 | ■ | Y-747U | 4694 | | D-POWER 26 | 4694 |
| | | | | motore —> 1713818 | | | | | | | |
| KAPPA 2000 16V TURBO | 2.0 | 151 | 02.95 - 02.01 | 838A4.000 | 4 | | BP6ET | 1263 | | LPG 2 | 1497 |
| KAPPA 2000 20V 150CV | 2.0 | 110 | 01.95 - | 838A1.000 | 5 | | BKR6EKC | 2848 | 26 | LPG 1 | 1496 |
| KAPPA 2000 TURBO 20V | 2.0 | 162 | 07.98 - 02.01 | 175 A3.000 | 5 | | BKUR6ET | 6437 | 27 | LPG 1 | 1496 |
| KAPPA 2400 20V 175CV | 2.4 | 129 | 01.95 - 02.01 | 838A2.000 | 5 | | BKR6EKC | 2848 | 26 | LPG 1 | 1496 |
| KAPPA 3000 V6 24V | 3.0 | 150 | 01.95 - 02.01 | 838B.000 | 6 | 0,9 | PFR6B | 3500 | | PFR7B | 4853 |
| KAPPA TD | 2.4 | | 10.94 - 12.98 | 838 A3.000 | 5 | ■ | Y-910J | 3617 | | D-POWER 3 | 3617 |
| Lybra 1.9 JTD | 1.9 | 77 | 12.99 - 09.00 | AR32302 dal n. | 4 | ■ | Y-534J | 3413 | | D-POWER 36 | 3413 |
| | | | | motore 1713819 —> | | | | | | | |
| Lybra 1.9 JTD | 1.9 | 77 | 09.98 - 11.99 | AR32302 fino a n. | 4 | ■ | Y-747U | 4694 | | D-POWER 26 | 4694 |
| | | | | motore —> 1713818 | | | | | | | |
| Lybra 1.9 JTD | 1.9 | 81 | 09.00 - 05.01 | AR 37101 | 4 | ■ | Y-534J | 3413 | | D-POWER 36 | 3413 |
| Lybra 1.9 JTD | 1.9 | 85 | 06.01 - 04 | 937A2000 | 4 | ■ | Y-534J | 3413 | | D-POWER 36 | 3413 |
| Lybra 16V;Lx;S.W. | 1.6 | 76 | 09.99 - | 182 A4.000 | 4 | 0,9 | BKR5EZ | 7642 | 36 | LPG 1 | 1496 |
| Lybra 16V;Lx;S.W. | 1.8 | 96 | 09.99 - 08.02 | 839 A4.000 | 4 | | BKR6EKC | 2848 | 26 | LPG 1 | 1496 |
| Lybra 16V;Lx;S.W. | 1.8 | 96 | 09.02 - | 839 A4.000 | 4 | 0,9 | BKR6EZ | 4619 | 38 | LPG 1 | 1496 |
| Lybra 2.4 JTD | 2.4 | 100 | 11.99 - 12.00 | AR 32501 dal n. | 5 | ■ | Y-534J | 3413 | | D-POWER 36 | 3413 |
| | | | | motore 1713819 —> | | | | | | | |
| Lybra 2.4 JTD | 2.4 | 100 | 09.99 - 11.99 | AR 32501 fino a | 5 | ■ | Y-747U | 4694 | | D-POWER 26 | 4694 |
| | | | | n. motore —> 1713818 | | | | | | | |



ℓ kW



Cyl.

Order-
No. No.LPG/CNG
D-PowerOrder-
No.**LANCIA**

| | | | | | | | | | | | |
|----------------------------------|-----|-----|---------------|------------------------|---|-----|-------------|-------|----|------------|-------|
| Lybra 2.4 JTD | 2.4 | 103 | 09.00 - 05.02 | 839 A6.000 | 5 | █ | Y-534J | 3413 | | D-POWER 36 | 3413 |
| Lybra 2.4 JTD | 2.4 | 110 | 05.02 - 04 | 841C000 | 5 | █ | Y-534J | 3413 | | D-POWER 36 | 3413 |
| Lybra 20V;Lx;S.W.;Aut. | 2.0 | 110 | 09.99 - 08.02 | 182 B7.000 | 5 | | BKR6EKC | 2848 | 26 | LPG 1 | 1496 |
| Lybra 20V;Lx;S.W.;Aut. | 2.0 | 110 | 09.02 - | 182 B7.000 | 5 | 0,9 | BKR6EZ | 4619 | 38 | LPG 1 | 1496 |
| Musa 1.3 MJET 16V 70CV | 1.3 | 51 | 09.04 - | 188A9.000 | 4 | █ | Y8003J | 97256 | | D-POWER 62 | 97256 |
| Musa 1.3 MJET 16V 90CV | 1.3 | 66 | 02.05 - | 199A3000 | 4 | █ | Y8003J | 97256 | | D-POWER 62 | 97256 |
| Musa 1.4 | 1.4 | 57 | 09.05 - | 350A1.000 | 4 | 1,0 | ZKR7A-10 | 1691 | | ZKR7A-10 | 1691 |
| Musa 1.4 16V | 1.4 | 66 | 10.04 - | 192B2.000 | 4 | 1,0 | DCPR7E-N-10 | 4983 | | | |
| Musa 1.4 16V | 1.4 | 70 | 03.05 - | 843A1.000 | 4 | 1,0 | DCPR7E-N-10 | 4983 | | | |
| Musa 1.4 16V | 1.4 | 70 | 09.04 - 02.05 | 843A1.000 | 4 | 0,9 | DCPR7E-N | 4795 | | DCPR8EIX | 6546 |
| Musa 1.9 MJET 100CV | 1.9 | 73 | | 188B2000 | 4 | █ | Y-534J | 3413 | | D-POWER 36 | 3413 |
| Phedra 2.2 JTD | 2.2 | 94 | 09.02 - 05.03 | 4HW (DW12ATED4) | 4 | █ | Y-504R | 4359 | | D-POWER 24 | 1441 |
| | | | | fino a n. ric. —> 9666 | | | | | | | |
| Phedra 3,0 V6 | 3.0 | 150 | 10.02 - | XFW | 6 | 1,1 | PLFR5A-11 | 6240 | | LPG 7 | 1640 |
| Phedra JTD | 2.0 | 79 | 09.02 - 05.03 | RHM (DW10ATED4) | 4 | █ | Y-504R | 4359 | | D-POWER 24 | 1441 |
| | | | | fino a n. ric. —> 9666 | | | | | | | |
| Phedra JTD | 2.0 | 80 | 09.02 - | DW10ATED4/RHT, RHW | 4 | █ | Y-504R | 4359 | | D-POWER 24 | 1441 |
| Phedra JTD | 2.0 | 80 | 09.02 - 05.03 | RHW (DW10ATED4) | 4 | █ | Y-504R | 4359 | | D-POWER 24 | 1441 |
| | | | | fino a n. ric. —> 9666 | | | | | | | |
| Phedra JTD | 2.2 | 94 | 06.03 - | DW12ATED4/4HW | 4 | █ | Y-504R | 4359 | | D-POWER 24 | 1441 |
| Prisma | 1.3 | 57 | 12.82 - 12.89 | 831A2.- 831B000 | 4 | 0,8 | BPR7ES | 2023 | 19 | BPR8EIX | 6684 |
| Prisma / IE | 1.6 | 66 | 05.86 - 12.89 | 831B7.. | 4 | 0,8 | BPR7ES | 2023 | 19 | BPR8EIX | 6684 |
| Prisma / LX | 1.5 | 59 | - 89 | 838C.. | 4 | 0,8 | BPR7ES | 2023 | 19 | BPR8EIX | 6684 |
| Prisma i.e.Integrale / 4WD | 2.0 | 82 | 07.87 - 12.89 | 831B4.046 | 4 | 0,8 | BPR7ES | 2023 | 19 | BPR8EIX | 6684 |
| Prisma TD | 1.9 | 48 | 06.84 - 12.89 | 831 D. 000 | 4 | █ | Y-924J | 7906 | | D-POWER 1 | 7906 |
| Prisma TD | 1.9 | 59 | 07.85 - | | 4 | █ | Y-908R | 4585 | | D-POWER 1 | 7906 |
| Prisma TD ds | 1.9 | 59 | 05.85 - 12.89 | 831 D. | 4 | █ | Y-924J | 7906 | | D-POWER 1 | 7906 |
| Thema 16V / LE / LS | 2.0 | 112 | - 01.95 | 834F1.000 Cat. | 4 | 0,8 | BPR7ES | 2023 | 19 | BPR8EIX | 6684 |
| Thema Turbo 16V LS/LX | 2.0 | 132 | - 01.95 | 834C1.000 | 4 | | BP6ET | 1263 | | LPG 2 | 1497 |
| Thema 8.32 | 3.0 | 150 | 90 - 92 | F105L Cat. | 8 | 0,7 | DCPR9E | 2641 | | DCPR9EIX | 2316 |
| Thema 8.32 | 3.0 | 158 | - 89 | F105L | 8 | 0,7 | D8EA | 2120 | | | |
| Thema i.e. Turbo 16V | 2.0 | 148 | 04.94 - | | 4 | | BP6ET | 1263 | | LPG 2 | 1497 |
| Thema i.e. / Wagon | 2.0 | 85 | - 01.95 | 834B.146 Cat. | 4 | 0,8 | BPR7ES | 2023 | 19 | BPR8EIX | 6684 |
| Thema i.e. 16V Tur. SW/LS/LX | 2.0 | 108 | - 01.95 | 834B2.000 | 4 | | BP6ET | 1263 | | LPG 2 | 1497 |
| Thema i.e. Turbo | 2.0 | 122 | - 01.95 | 834C146 | 4 | 0,8 | BPR7ES | 2023 | 19 | BPR8EIX | 6684 |
| Thema i.e. Turbo 16V LX | 2.0 | 148 | 10.91 - 01.95 | 834F2.000 Cat. | 4 | | BP6ET | 1263 | | LPG 2 | 1497 |
| Thema i.e. Turbo 16V S.W.Fairway | 2.0 | 148 | 04.94 - 01.95 | 834C1.246 | 4 | | BUR6ET | 3172 | 1 | LPG 2 | 1497 |
| Thema i.e. Turbo SW | 2.0 | 110 | - 01.95 | 834C146 Cat. | 4 | 0,8 | BPR7ES | 2023 | 19 | BPR8EIX | 6684 |
| Thema i.e. V6 | 2.8 | 110 | - 01.95 | PRV834AB Cat. | 6 | 1,0 | BPR6EFS | 3623 | 7 | LPG 5 | 1516 |
| Thema i.e. V6 LS / LX / SW | 3.0 | 126 | 92 - 01.95 | 834F.000 | 6 | 0,8 | BPR7ES | 2023 | 19 | BPR8EIX | 6684 |
| Thema i.e.16V S.W. Fairway | 2.0 | 112 | 04.94 - 01.95 | 834F1.000 | 4 | 0,8 | BPR7ES | 2023 | 19 | BPR8EIX | 6684 |
| Thema TD | 2.4 | 74 | 01.93 - | | 4 | █ | Y-914U | 2643 | | D-POWER 1 | 7906 |
| Thema TD | 2.5 | 85 | 01.94 - 12.94 | | 4 | █ | Y-926U | 7119 | | | |
| Thesis 2.0 20 V TB | 2.0 | 136 | 11.02 - | 841E.000 | 5 | | BKUR6ETB | 6992 | | | |
| Thesis 2.0 TB cambio 6 marce | 2.0 | 136 | 11.02 - | 841E.000 | 5 | | BKUR6ETB | 6992 | | | |
| Thesis 2.4 20V | 2.4 | 125 | 11.02 - | 841D.000 | 5 | 0,9 | BKR6EZ | 4619 | 38 | LPG 1 | 1496 |
| Thesis 2.4 JTD | 2.4 | 110 | 07.02 - 04.03 | 841C000 | 5 | █ | Y-534J | 3413 | | D-POWER 36 | 3413 |
| Thesis 2.4 JTD 20V | 2.4 | 120 | 05.03 - 10.03 | 841M000 / 841N000 | 5 | █ | YE07 | 6092 | | | |
| Thesis 2.4 JTD 20V | 2.4 | 129 | 11.03 - | 841G000 / 841H000 / | 5 | █ | YE07 | 6092 | | | |
| | | | | 841P000 | | | | | | | |
| Thesis 3.0 24V V6 | 3.0 | 158 | 11.02 - | 841A.000 | 6 | 0,9 | PFR6B | 3500 | | PFR7B | 4853 |
| Thesis 3.2 24V V6 | 3.2 | 169 | 11.03 - | 841A.000 | 6 | 0,9 | PFR6B | 3500 | | PFR7B | 4853 |



l kW

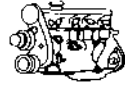

Cyl.

Order-
No. No.LPG/CNG
D-PowerOrder-
No.**LANCIA**

| | | | | | | | | | | | |
|----------------------------------|-----|-----|---------------|--------------------|---|-----|-------------|-------|----|------------|-------|
| Trevi | 1.6 | 74 | - 85 | 828B.000 | 4 | 0,8 | BPR7ES | 2023 | 19 | BPR8EIX | 6684 |
| Trevi i.e. / Volumex | 2.0 | 90 | - 85 | 828B4.000-B7.000 | 4 | 0,8 | BPR7ES | 2023 | 19 | BPR8EIX | 6684 |
| Y | 1.4 | 55 | 01.96 - 12.97 | | 4 | | BCPR6ET | 2197 | | LPG 3 | 1498 |
| Y 8 V | 1.2 | 44 | 01.96 - 03.97 | 840.A3.000 | 4 | 0,8 | BCPR6ES | 2330 | 12 | LPG 3 | 1498 |
| Y 8 V Elefantino Blu -unica | 1.2 | 44 | 10.99 - 09.03 | 188A4.000 | 4 | 0,9 | BKR5EZ | 7642 | 36 | LPG 1 | 1496 |
| Y 8 V LS,LE;ECVT | 1.2 | 44 | 01.96 - 10.99 | 840 A3.000 | 4 | 0,8 | BCPR6ES | 2330 | 12 | LPG 3 | 1498 |
| Y 1.2 8V: Vanity- LS-Unica | 1.2 | 44 | 10.00 - 12.03 | 188A4.000 | 4 | 0,9 | BKR5EZ | 7642 | 36 | LPG 1 | 1496 |
| Y 1.2 16V- LS-LX-Unica | 1.2 | 59 | 10.00 - 11.02 | 188A5.000 | 4 | 0,9 | DCPR8E-N | 5692 | | | |
| Y 1.2 16V- LS-LX-Unica | 1.2 | 59 | 12.02 - 12.03 | 188A5.000 | 4 | 0,9 | DCPR7E-N | 4795 | | DCPR8EIX | 6546 |
| Y 10 4WD | 1.0 | 33 | 85 - 10.96 | 156A2.246 | 4 | 0,8 | BCPR6ES | 2330 | 12 | LPG 3 | 1498 |
| Y 10 /4x4 | 1.1 | 37 | 09.86 - 10.96 | 156C.046 | 4 | 0,6 | BCPR7ES | 3330 | | BCPR7EIX | 5690 |
| Y 10 1300; G.T. | 1.3 | 53 | 11.87 - 10.96 | 146A5.046 | 4 | 0,8 | BPR6ES | 7822 | 2 | LPG 2 | 1497 |
| Y 10 Fire | 1.0 | 33 | 85 - 10.96 | 156A2.000 | 4 | 0,8 | BCPR6ES | 2330 | 12 | LPG 3 | 1498 |
| Y 10 Selectronic i.e. | 1.1 | 37 | - 10.96 | 156C.046 Cat. | 4 | 0,8 | BCPR6ES | 2330 | 12 | LPG 3 | 1498 |
| Y 16V | 1.2 | 63 | 04.97 - 03.00 | 176B9.000 | 4 | 0,9 | DCPR8E | 4339 | | DCPR9EIX | 2316 |
| Y 16V elefantino Blu /Rosso | 1.2 | 59 | 10.00 - 11.02 | 188A5.000 | 4 | 0,9 | DCPR8E-N | 5692 | | | |
| Y 16V LE | 1.2 | 63 | 02.98 - 09.00 | 176B9.000 | 4 | 0,9 | DCPR8E | 4339 | | DCPR9EIX | 2316 |
| Y 16V,LE,LS,LX, Elefantino Rosso | 1.2 | 63 | 04.97 - 04.00 | 176B9.000 | 4 | 0,9 | DCPR8E | 4339 | | DCPR9EIX | 2316 |
| Y Elefantino Blu | 1.1 | 40 | 05.97 - 04.00 | 176B2.000 | 4 | 0,9 | BKR6E | 6962 | 28 | LPG 1 | 1496 |
| Y Elefantino Blu | 1.1 | 40 | 05.97 - 09.00 | 176B2.000 | 4 | 0,8 | BCPR6ES | 2330 | 12 | LPG 3 | 1498 |
| Y i. 12V | 1.4 | 55 | 01.96 - 01.98 | 840 A2.000 - 4.000 | 4 | | BKR6EKC | 2848 | 26 | LPG 1 | 1496 |
| Y i.e. 12V | 1.4 | 59 | 01.96 - 01.98 | 840A4.000 | 4 | | BKR6EKC | 2848 | 26 | LPG 1 | 1496 |
| Ypsilon 1,2 | 1.2 | 44 | 10.04 - | 188A4.000 | 4 | 1,0 | DCPR7E-N-10 | 4983 | | | |
| Ypsilon 1,2 | 1.2 | 51 | 09.10 - | | 4 | 1,0 | ZKR7A-10 | 1691 | | LPG 8 | 6806 |
| Ypsilon 1,2 8V | 1.2 | 44 | 09.03 - 10.04 | 188A4.000 | 4 | 0,9 | BKR5EZ | 7642 | 36 | LPG 1 | 1496 |
| Ypsilon 1,4 | 1.4 | 57 | 09.06 - | 350A1000 | 4 | 1,0 | ZKR7A-10 | 1691 | | ZKR7A-10 | 1691 |
| Ypsilon 1.3 MJET 16V 105CV | 1.3 | 77 | 09.07 - | 199A3000 | 4 | █ | Y8003J | 97256 | | D-POWER 62 | 97256 |
| Ypsilon 1.3 MJT 75CV | 1.3 | 55 | 09.06 - | 199A2000 | 4 | █ | Y8003J | 97256 | | D-POWER 62 | 97256 |
| Ypsilon 1.3 MJT 90CV | 1.3 | 66 | 09.06 - | 199A3000 | 4 | █ | Y8003J | 97256 | | D-POWER 62 | 97256 |
| Ypsilon 1.4 16V | 1.4 | 70 | 02.05 - | 843A1.000 | 4 | 1,0 | DCPR7E-N-10 | 4983 | | | |
| Ypsilon 1.4 16V | 1.4 | 70 | 09.03 - 02.05 | 843A1.000 | 4 | 0,9 | DCPR7E-N | 4795 | | DCPR8EIX | 6546 |
| Ypsilon 1.4 GPL | 1.4 | 57 | 04.09 - | | 4 | 1,0 | ZKR7A-10 | 1691 | | LPG 8 | |
| Ypsilon 16V | 1.2 | 57 | 02.05 - | 188A5.000 | 4 | 1,0 | DCPR7E-N-10 | 4983 | | | |
| Ypsilon 16V | 1.2 | 57 | 09.03 - 02.05 | 188A5.000 | 4 | 0,9 | DCPR7E-N | 4795 | | DCPR8EIX | 6546 |
| Ypsilon MJT | 1.3 | 51 | 10.03 - 06 | 188A4000 | 4 | █ | Y8003J | 97256 | | D-POWER 62 | 97256 |
| Z TD | 1.9 | 68 | 04.95 - | XUD 9TE | 4 | █ | Y-923U | 3380 | | D-POWER 1 | 7906 |
| Z TD | 2.1 | 80 | 07.96 - | XUD11ATE | 4 | █ | Y-923U | 3380 | | D-POWER 1 | 7906 |
| Z i.e. | 2.0 | 89 | 04.99 - 12.01 | RFV | 4 | | BKR5EK | 7956 | 23 | LPG 1 | 1496 |
| Z i.e. Turbo,LS | 2.0 | 108 | 10.94 - 03.99 | RGX | 4 | | BKR6EK | 2288 | 20 | BKR6EQU | 3199 |

LAND ROVER

| | | | | | | | | | | | |
|---------------------------|-----|----|---------|--|---|-----|--------|------|---|-------|------|
| 90 | | | 83 - | | 4 | █ | Y-907R | 4479 | | | |
| 110 | | | 83 - | | 4 | █ | Y-907R | 4479 | | | |
| 88/109 2.3 L rap vol 7/1 | 2.3 | | - 85 | | 4 | 0,7 | B6ES | 7310 | | | |
| 88/109 2.3 L rap vol 8/1 | 2.3 | | - 85 | | 4 | 0,7 | BP5ES | 6511 | 8 | LPG 2 | 1497 |
| 90/110 2.3 L rap vol 7/1 | 2.3 | | - 85 | | 4 | 0,7 | B6ES | 7310 | | | |
| 90/110 2.3 L rap vol. 8/1 | 2.3 | | - 85 | | 4 | 0,7 | BP5ES | 6511 | 8 | LPG 2 | 1497 |
| 90/110 2.5 L | 2.5 | | - 85 | | 4 | 0,7 | BP6ES | 7811 | 4 | LPG 2 | 1497 |
| 90/110 V8 | | | 83 - | | 8 | 0,7 | BP6ES | 7811 | 4 | LPG 2 | 1497 |
| Country TD | 2.5 | 83 | 01.89 - | | 4 | █ | Y-909R | 4602 | | | |
| Defender 2.5 | 2.5 | | 90 - | | 6 | 0,8 | BP6ES | 7811 | 4 | LPG 2 | 1497 |
| Defender 3.5 V8 | 3.5 | | 90 - | | 8 | 0,9 | BPR5ES | 7422 | 6 | LPG 2 | 1497 |



ℓ kW

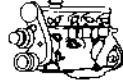

Cyl.

Order-
No.V-LINE
No.LPG/CNG
D-PowerOrder-
No.**LAND ROVER**

| | | | | | | | | | | | |
|------------------------|------|-----|---------------|---------------------------|---|-----|----------|------|----|------------|------|
| Defender TDI | 2.5 | 83 | 11.89 - 10.98 | 200/300 Gemini 1 | 4 | █ | Y-729U | 4119 | | D-POWER 34 | 4119 |
| Defender TDI 90 & 110 | 2.5 | 102 | 01.99 - | | 4 | █ | Y-924J | 7906 | | D-POWER 1 | 7906 |
| Discovery | 4.0 | | 94 - 99 | | 8 | 0,8 | BPR6ES | 7822 | 2 | LPG 2 | 1497 |
| Discovery | 4.0 | | 10.98 - | | 8 | 1,1 | PFR6N-11 | 3546 | | LPG 1 | 1496 |
| Discovery TDi ES | 2.5 | 83 | 09.89 - | | 4 | █ | Y-729U | 4119 | | D-POWER 34 | 4119 |
| Discovery TDi Vogue ES | 2.5 | 90 | 10.93 - | | 4 | █ | Y-729U | 4119 | | D-POWER 34 | 4119 |
| Discovery 2.0 | 2.0 | 99 | 06.93 - 01.99 | Mpi | 4 | 0,9 | BKR6E | 6962 | 28 | LPG 1 | 1496 |
| Discovery 3 | 4.4 | | 08.04 - | | 8 | 1,0 | IFR5N10 | 7866 | | | |
| Discovery TDI | 2.5 | 83 | 09.89 - 01.99 | 200/300 Gemini 1 | 4 | █ | Y-729U | 4119 | | D-POWER 34 | 4119 |
| Discovery V8 | 3.5 | 107 | 09.89 - 01.99 | V8 3.5 | 8 | 0,8 | BPR6ES | 7822 | 2 | LPG 2 | 1497 |
| Discovery V8 | 3.9 | 136 | 02.99 - | V8 | 8 | 0,8 | BPR6ES | 7822 | 2 | LPG 2 | 1497 |
| Freelander | 1.8 | 87 | 97 - | K SERIES | 4 | 1,1 | PFR6N-11 | 3546 | | LPG 1 | 1496 |
| Freelander | 2.0 | | 01 - | KV6 | 6 | 1,1 | PFR6N-11 | 3546 | | LPG 1 | 1496 |
| Freelander TD4 | 2.0 | 80 | 08.98 - | M47D20 (BMW) | 4 | █ | Y-507J | 2691 | | D-POWER 32 | 2691 |
| Freelander TDI | 2.0 | 71 | 10.97 - 08.98 | 20 T2R | 4 | █ | Y-730U | 6704 | | D-POWER 17 | 6704 |
| Freelander TDi | 2.5 | 102 | 05.98 - | | 5 | █ | Y-924J | 7906 | | D-POWER 1 | 7906 |
| Freelander V6 | 2.5 | 130 | 09.00 - | KV6 | 6 | 1,1 | PFR6N-11 | 3546 | | LPG 1 | 1496 |
| Land Rover | 2.3 | | 09.83 - | | 4 | 0,8 | BP6EFS | 3812 | 5 | LPG 5 | 1516 |
| Land Rover | 2.5 | 62 | 09.83 - | | 4 | 0,7 | BP6ES | 7811 | 4 | LPG 2 | 1497 |
| Land Rover | 3.5 | 103 | 09.83 - 07.90 | V8 | 8 | 0,7 | BP6ES | 7811 | 4 | LPG 2 | 1497 |
| Land Rover (90,110) | 2.25 | | 83 - | | 4 | █ | Y-208T | 1250 | | | |
| Land Rover (90,110) | 2.5 | | 83 - | | 4 | █ | Y-208T | 1250 | | | |
| Land Rover County D | | | 01.89 - | | 4 | █ | Y-909R | 4602 | | | |
| Range Rover | 2.5 | 66 | 04.86 - 10.92 | VM UNIT (NOT GEMINI ENG.) | 4 | █ | Y-909R | 4602 | | | |
| Range Rover | 2.5 | 100 | 09.94 - | M51 D25 (BMW) | 6 | █ | Y-924J | 7906 | | D-POWER 1 | 7906 |
| Range Rover | 2.5 | | 09.89 - | 200/300 Gemini 1 | 4 | █ | Y-729U | 4119 | | D-POWER 34 | 4119 |
| Range Rover | 3.5 | | 08.81 - 10.89 | V8EFI | 8 | 0,8 | BPR6ES | 7822 | 2 | LPG 2 | 1497 |
| Range Rover | 3.9 | 127 | 11.88 - 10.95 | V8 | 8 | 0,8 | BPR6ES | 7822 | 2 | LPG 2 | 1497 |
| Range Rover | 4.0 | 131 | 01.99 - 02 | | 8 | 1,1 | PFR6N-11 | 3546 | | LPG 1 | 1496 |
| Range Rover | 4.0 | | 09.94 - 12.98 | | 8 | 0,8 | BPR6ES | 7822 | 2 | LPG 2 | 1497 |
| Range Rover | 4.2 | | 10.92 - 12.94 | V8 | 8 | 0,8 | BPR6ES | 7822 | 2 | LPG 2 | 1497 |
| Range Rover | 4.4 | 210 | 09.99 - | BMW M62 B44 | 8 | | BKR6EQUP | 3199 | 30 | LPG 1 | 1496 |
| Range Rover | 4.6 | 150 | 01.99 - | | 8 | 1,1 | PFR6N-11 | 3546 | | LPG 1 | 1496 |
| Range Rover | 4.6 | 165 | 09.94 - 10.98 | V8 | 8 | 0,8 | BPR6ES | 7822 | 2 | LPG 2 | 1497 |
| Range Rover 3 | 3.0 | 130 | 03.02 - | M57 D30 BMW | 6 | █ | Y-507J | 2691 | | D-POWER 32 | 2691 |
| Range Rover 3 | 3.0 | | 02 - | M57 D30 (BMW) | 6 | █ | Y-507J | 2691 | | D-POWER 32 | 2691 |
| Range Rover 4 | 4.2 | | 05.05 - | | 8 | 1,0 | IFR5N10 | 7866 | | | |
| Range Rover 4 | 4.4 | | 05.05 - | | 8 | 1,0 | IFR5N10 | 7866 | | | |
| Range Rover TDI | 2.5 | 83 | 01.86 - 12.94 | ETC 9091 N | 4 | █ | Y-729U | 4119 | | D-POWER 34 | 4119 |
| Range Rover Vogue TD | 2.5 | 87 | 01.90 - 09.94 | VM 425 SLIRR | 4 | █ | Y-923U | 3380 | | D-POWER 1 | 7906 |
| Range Rover Vogue TD | 2.5 | 87 | 01.90 - 09.94 | VM HR-492 | 4 | █ | Y-923U | 3380 | | D-POWER 1 | 7906 |

LDV

| | | | | | | | | | | | |
|-----|-----|--|---------|------|---|---|--------|------|--|--|--|
| Cub | 2.3 | | 09.98 - | LD23 | 4 | █ | Y-530J | 6586 | | | |
|-----|-----|--|---------|------|---|---|--------|------|--|--|--|

LEXUS

| | | | | | | | | | | | |
|-------------------------|-----|-----|------------|--------|---|-----|------------|------|--|---------|------|
| ES 300 (MCV20) | 3.0 | | 01.00 - 03 | 2JZ-GE | 6 | | BKR6EKP-11 | 3452 | | | |
| ES 300 (MCV30) | 3.0 | | 01.04 - | 1MZ-FE | 6 | 1,1 | IFR6T11 | 4589 | | IFR6T11 | 4589 |
| GS 300 | 3.0 | 163 | 97 - | 2TZ-GE | 6 | | BKR6EKP-11 | 3452 | | | |
| GS 300 (JZS160) | 3.0 | | 01.00 - | 1MZ-FE | 6 | | BKR6EKP-11 | 3452 | | | |
| GS 300 (JZS160, UZS161) | 3.0 | 161 | 01.02 - | 2JZ-GE | 6 | 1,1 | BKR6EP-11 | 2978 | | LPG 1 | 1496 |
| GS 300 (JZS147) | 3.0 | 156 | 93 - 99 | 2JZ-GE | 6 | 1,1 | BKR5EP-11 | 3440 | | LPG 1 | 1496 |



ℓ kW



Cyl.

Order-
No. No.LPG/CNG
D-PowerOrder-
No.**LEXUS**

| | | | | | | | | | | | |
|---------------------------|-----|-----|---------------|--------------------|---|-----|-----------|------|--|----------|------|
| GS 300 (UZS190)(GRS190) | 3.0 | 183 | 05.05 - | 3GR-FE | 6 | 1,1 | IFR6T11 | 4589 | | IFR6T11 | 4589 |
| GS 300 (UZS190)(GRS190) | 3.0 | | 05.05 - | 3GR-FSE | 6 | 1,1 | IFR6T11 | 4589 | | IFR6T11 | 4589 |
| GS 430 (GRS190) | 4.3 | 208 | 08.05 - | 3UZ-FE | 8 | 1,1 | IFR6T11 | 4589 | | IFR6T11 | 4589 |
| GS 430 (JZS160, UZS161) | 4.3 | 208 | 01.02 - | 3UZ-FE | 6 | 1,1 | IFR6T11 | 4589 | | IFR6T11 | 4589 |
| GS 430 (UZS190) | 4.3 | 208 | 08.05 - | 3UZ-FE | 8 | 1,1 | IFR6T11 | 4589 | | IFR6T11 | 4589 |
| IS 200 (GXE10) | 2.0 | 114 | 01.00 - | 1G-FE | 6 | 1,1 | IFR6T11 | 4589 | | IFR6T11 | 4589 |
| IS 300 (GXE10)(JCE10/ 15) | 2.0 | 114 | 09.01 - | 1G-FE | 6 | 1,1 | IFR6T11 | 4589 | | IFR6T11 | 4589 |
| IS 300 (GXE10)(JCE10/ 15) | 3.0 | | 01.02 - | 2JZ-GE | 6 | 1,1 | BKR6EP-11 | 2978 | | LPG 1 | 1496 |
| LS 400 | 4.0 | 180 | 90 - 94 | 1UZ-FE Cat. | 8 | 1,1 | BKR6EP-11 | 2978 | | LPG 1 | 1496 |
| LS 400 | 4.0 | 194 | 10.94 - 12.99 | 1UZ-FE | 8 | 0,8 | BKR6EP-8 | 2215 | | LPG 1 | 1496 |
| LS 400 | 4.0 | | 06.90 - 06.97 | 1UAZ-FE | 8 | 1,1 | BKR5EP-11 | 3440 | | LPG 1 | 1496 |
| LS 400 (UCF20) | 4.0 | | 01.00 - | 1UZ-FE | 8 | 1,1 | IFR6T11 | 4589 | | IFR6T11 | 4589 |
| LS 430 (UCF30) | 4.3 | 207 | 08.00 - | 3UZ-FE with TWC | 8 | 1,1 | IFR6T11 | 4589 | | IFR6T11 | 4589 |
| LS 430 (UCF30) | 4.3 | | 08.00 - | 3UZ-FE without TWC | 8 | 0,8 | BKR6EYA | 2249 | | LPG 1 | 1496 |
| LS 460 (USF40 , 41) | 4.6 | | 09.06 - | 1UR-FE | 8 | 1,1 | ILFR6T11 | 4904 | | ILFR6T11 | 4904 |
| LX 470 (UZJ100) | 4.7 | | 01.00 - | 2UZ-FE with TWC | 8 | 1,1 | IFR6T11 | 4589 | | IFR6T11 | 4589 |
| LX 470 (UZJ100) | 4.7 | | 01.00 - | 2UZ-FE without TWC | 8 | 0,8 | BKR6EYA | 2249 | | LPG 1 | 1496 |
| RX 300 (MCU15) | 3.0 | 150 | 07.00 - 06 | 1MZ-FE | 6 | 1,1 | IFR6T11 | 4589 | | IFR6T11 | 4589 |
| RX 300 (MCU35,38) | 3.0 | | 01.04 - 06 | 1MZ-FE | 6 | 1,1 | IFR6T11 | 4589 | | IFR6T11 | 4589 |
| RX 300 (MCU35,38) | 3.3 | | 01.04 - 06 | 3MZ-FE | 6 | 1,1 | IFR6T11 | 4589 | | IFR6T11 | 4589 |
| RX 330 (MCU35,38) | 3.0 | | 01.04 - | 1MZ-FE | 6 | 1,1 | IFR6T11 | 4589 | | IFR6T11 | 4589 |
| RX 330 (MCU35,38) | 3.3 | | 01.04 - | 3MZ-FE | 6 | 1,1 | IFR6T11 | 4589 | | IFR6T11 | 4589 |
| RX 400 h (MHU38) | 3.3 | 155 | 03.05 - | 3MZ-FE | 6 | 1,1 | IFR6T11 | 4589 | | IFR6T11 | 4589 |
| SC 430 (UZZ40) | 4.3 | 210 | 05.01 - | 3UZ-FE | 8 | 1,1 | IFR6T11 | 4589 | | IFR6T11 | 4589 |

LEYLAND

| | | | | | | | | | | | |
|------------------|-----|--|---------|--|---|---|----------|------|--|-----------|------|
| 200-Serie D | | | 03.89 - | | 6 | | only OES | | | | |
| 400-Serie LTD DI | 2.5 | | 01.87 - | | 5 | ☑ | Y-924J | 7906 | | D-POWER 1 | 7906 |

LEYLAND DAF

| | | | | | | | | | | | |
|--------|-----|--|------------|----------------|---|-----|--------|------|---|-----------|------|
| Pilot | 1.9 | | 96 - | PEUGEOT | 4 | ☑ | Y-923U | 3380 | | D-POWER 1 | 7906 |
| Sherpa | 1.7 | | - 86 | | 4 | 0,9 | BP6EF | 4666 | | | |
| Sherpa | 1.7 | | 86 - | | 4 | 0,7 | BP6ES | 7811 | 4 | LPG 2 | 1497 |
| Sherpa | 2.0 | | - 86 | | 4 | 0,9 | BP6EF | 4666 | | | |
| Sherpa | 2.0 | | 86 - | | 4 | 0,7 | BP6ES | 7811 | 4 | LPG 2 | 1497 |
| Sherpa | 2.0 | | 86 - 88 | PERKINS PRIMA | 4 | ☑ | Y-924J | 7906 | | D-POWER 1 | 7906 |
| Sherpa | 2.5 | | 04.86 - 89 | | 4 | ☑ | Y-208T | 1250 | | | |
| Sherpa | 2.5 | | 89 - | PEUGEOT ENGINE | 4 | ☑ | Y-923U | 3380 | | D-POWER 1 | 7906 |

LINCOLN

| | | | | | | | | | | | |
|-------------|-----|--|---------|---------------------|---|-----|------|------|--|-------|------|
| Continental | 3.8 | | 82 - | 3 2 bbl CID232 | 6 | 0,9 | FR4 | 5188 | | | |
| Continental | 5.0 | | 80 - 83 | F EFI CID302 | 8 | 1,5 | UR45 | 2451 | | UR5IX | 7177 |
| Continental | 5.8 | | 80 - | G 2 bbl CID351 | 8 | 1,5 | UR45 | 2451 | | UR5IX | 7177 |
| Mark VI | 5.0 | | 80 - 83 | F 2 bbl, EFI CID302 | 8 | 1,5 | UR45 | 2451 | | UR5IX | 7177 |
| Mark VI | 5.8 | | 80 - | G 2 bbl CID351 | 8 | 1,5 | UR45 | 2451 | | UR5IX | 7177 |
| Town Car | 5.0 | | 82 - 83 | F EFI CID302 | 8 | 1,5 | UR45 | 2451 | | UR5IX | 7177 |

LOTUS

| | | | | | | | | | | | |
|-------------------|-----|----|---------|---------------------------|---|-----|----------|------|----|-------|------|
| Eclar | 2.2 | | 80 - 82 | | 4 | 0,8 | BPR6ES | 7822 | 2 | LPG 2 | 1497 |
| Elan SE 16V Turbo | 1.6 | | 10.89 - | | 4 | 0,8 | BKR6E | 6962 | 28 | LPG 1 | 1496 |
| Elan 1.6 16V | 1.6 | | 10.89 - | | 4 | 1,1 | BKR6E-11 | 2756 | 14 | LPG 1 | 1496 |
| Elise | 1.8 | 88 | 96 - | K- SERIES (Including) VVC | 4 | 1,1 | PFR6N-11 | 3546 | | LPG 1 | 1496 |



ℓ kW



Cyl.

Order-
No.VLINE
No.LPG/CNG
D-PowerOrder-
No.**LOTUS**

| | | | | | | | | | | | |
|----------------------------------|-----|-----|-------------|------|---|-----|----------|------|----|---------|------|
| Elise 111S | 1.8 | 107 | 99 - | | 4 | 1,1 | PFR6N-11 | 3546 | | LPG 1 | 1496 |
| Elite | 2.2 | 119 | 80 - 82 | | 4 | 0,8 | BPR6ES | 7822 | 2 | LPG 2 | 1497 |
| Esprit | 3.5 | 260 | 96 - | 918 | 8 | | BKR6EKC | 2848 | 26 | LPG 1 | 1496 |
| Esprit 2.0 Turbo 16V GT3 | 2.0 | | 10.96 - | | 4 | 0,8 | BPR6EKN | 1128 | | | |
| Esprit HC | 2.2 | | 85 - | DOHC | 4 | 0,8 | BPR7ES | 2023 | 19 | BPR7EIX | 4055 |
| Esprit S4 | 2.2 | | 93-07.96 | | 4 | 0,6 | BPR6EKN | 1128 | | | |
| Esprit SE 2.2 | 2.2 | | 11.94-07.96 | Cat. | 4 | 0,8 | BPR6EKN | 1128 | | | |
| Esprit Sport 300 | 2.2 | | 93 - | | 4 | 0,6 | BPR6EKN | 1128 | | | |
| Esprit Turbo | 2.2 | | 87 - | | 4 | 0,8 | BPR6ES | 7822 | 2 | LPG 2 | 1497 |
| Esprit Turbo SE | 2.2 | 197 | 89 - | 910S | 4 | 0,6 | BPR6EKN | 1128 | | | |
| Europa Special, Twin-Cam, S2, S1 | | | 85 - | | 4 | 0,8 | BP7ES | 2412 | | BPR7EIX | 4055 |
| Excel SA / SE | 2.2 | 135 | 85 - 91 | 912S | 4 | 0,8 | BPR7ES | 2023 | 19 | BPR7EIX | 4055 |
| Exige 1.8 16V | 1.8 | 132 | 07.00 - | | 4 | 0,8 | BKR7E | 6097 | | BKR7EVX | 3544 |

LUBLIN (Daewoo)

| | | | | | | | | | | | |
|------------|-----|----|---------|--|---|-----|--------|------|---|-------|------|
| Lublin 1.8 | 1.8 | 70 | 02.96 - | | 4 | 0,8 | BPR5EY | 2828 | 9 | LPG 2 | 1497 |
| Lublin 2.0 | 2.0 | 77 | 02.96 - | | 4 | 0,8 | BPR5EY | 2828 | 9 | LPG 2 | 1497 |

LWMC

| | | | | | | | | | | | |
|----------|-----|----|------|-------------------------|---|-----|----------|------|----|-------|------|
| Landwind | 2.4 | 92 | 05 - | 4G64S4M Mitsubishi | 4 | 1,1 | BKR5E-11 | 6953 | 33 | LPG 1 | 1496 |
| Landwind | 2.8 | | 05 - | JX493ZQ / ISUZU / 4JB1T | | | Y-904M1 | 7995 | | | |

MAHINDRA

| | | | | | | | | | | | |
|------------------|-----|----|---------|---------|---|--|--------|------|--|-----------|------|
| CJ 340 Classic D | 2.1 | 48 | 93 - | XD 4.90 | 4 | | Y-208T | 1250 | | | |
| CJ 540 D | 2.1 | 48 | 93 - | XD 4.90 | 4 | | Y-208T | 1250 | | | |
| CJ3 | | | 04.86 - | Peugeot | 4 | | Y-924J | 7906 | | D-POWER 1 | 7906 |
| CJ5 | | | 04.86 - | Peugeot | 4 | | Y-924J | 7906 | | D-POWER 1 | 7906 |

MARUTI

| | | | | | | | | | | | |
|-----|-----|----|---------|--|---|-----|--------|------|---|-------|------|
| 800 | 0.8 | 26 | 01.91 - | | 3 | 0,7 | BPR5ES | 7422 | 6 | LPG 2 | 1497 |
|-----|-----|----|---------|--|---|-----|--------|------|---|-------|------|

MASERATI

| | | | | | | | | | | | |
|------------------------|-----|-----|-------------|---------------|---|-----|--------|------|--|----------|------|
| 2.24 V | 2.0 | 180 | 88 - | AM 475 | 4 | 0,9 | DCPR8E | 4339 | | DCPR9EIX | 2316 |
| 222 | 2.0 | 162 | 01.89-10.89 | 471 | 4 | 0,8 | BP8ES | 2912 | | BPR9EIX | 6853 |
| 222 IE | 2.8 | | | V6 | 6 | 0,8 | DCPR7E | 3932 | | | |
| 228 I | 2.8 | 184 | 12.87 - | Bi Turbo Cat. | 6 | 0,8 | BP8ES | 2912 | | BPR9EIX | 6853 |
| 3200 GT | 3.2 | 271 | 12.98-09.01 | 585 | 8 | 0,7 | PMR8A | 5851 | | PMR8A | 5851 |
| 4.18 V | 2.0 | | 02.91 - | | 6 | 0,8 | BP8ES | 2912 | | BPR9EIX | 6853 |
| 4.24 V / Spider 24V | 2.0 | 180 | 90 - | 475 | 6 | 0,9 | DCPR8E | 4339 | | DCPR9EIX | 2316 |
| 420 / I / S / SI / | 2.0 | 138 | 01.87 - | 470 | 6 | 0,8 | BP8ES | 2912 | | BPR9EIX | 6853 |
| 422 | 2.0 | 164 | 88 - | AM 471 | 6 | 0,8 | BP8ES | 2912 | | BPR9EIX | 6853 |
| 422 | 2.8 | | | V6 | 6 | 0,8 | DCPR7E | 3932 | | | |
| 430 | 2.8 | 182 | 02.88 - | 473 Cat. | 6 | 0,8 | BP8ES | 2912 | | BPR9EIX | 6853 |
| Biturbo | 2.0 | 136 | 12.81-02.87 | 452 | 6 | 0,8 | BP8ES | 2912 | | BPR9EIX | 6853 |
| Biturbo | 2.5 | | 85 - | | 6 | 0,7 | BP8ES | 2912 | | BPR9EIX | 6853 |
| Biturbo | 2.8 | | 85 - | | 6 | 0,7 | BP8ES | 2912 | | BPR9EIX | 6853 |
| Coupè GT / Cambiocorsa | 4.2 | 287 | 06.02-11.03 | F136R | 8 | 0,7 | PMR8A | 5851 | | PMR8A | 5851 |
| Coupè GT / Cambiocorsa | 4.2 | 287 | 12.03 - | F136R | 8 | | PMR8B | 6378 | | PMR9B | 4717 |
| Ghibli | 2.0 | 209 | 09.96 - | 496 | 6 | 0,7 | DCPR9E | 2641 | | DCPR9EIX | 2316 |
| Ghibli | 2.0 | | | V8 | 8 | 0,7 | DCPR9E | 2641 | | DCPR9EIX | 2316 |
| Ghibli V6 | 2.8 | 209 | 11.95 - | | 6 | 0,8 | DCPR9E | 2641 | | DCPR9EIX | 2316 |
| GranSport | 4.2 | 294 | 09.04 - | F136S | 8 | | PMR8B | 6378 | | PMR9B | 4717 |



l kW

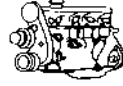

Cyl.

Order-
No. No.LPG/CNG
D-PowerOrder-
No.**MASERATI**

| | | | | | | | | | | | |
|----------------------------|-----|-----|---------------|-------------|---|-----|--------|------|--|----------|------|
| Karif | 2.8 | 165 | 04.88 - | 437 Cat. | 6 | 0,8 | BP8ES | 2912 | | BPR9EIX | 6853 |
| Quattroporte 4,2 | 4.2 | 294 | 11.02 - 11.03 | | 8 | 0,7 | PMR8A | 5851 | | PMR8A | 5851 |
| Quattroporte 4,2 | 4.2 | 294 | 12.03 - | F136S | 8 | | PMR8B | 6378 | | PMR9B | 4717 |
| Quattroporte i. V6 24V | 2.0 | 211 | 11.94 - 99 | 475 | 6 | 0,6 | DCPR9E | 2641 | | DCPR9EIX | 2316 |
| Quattroporte i. V6 24V | 2.8 | 209 | 11.95 - 01.99 | | 6 | 0,8 | DCPR9E | 2641 | | DCPR9EIX | 2316 |
| Quattroporte V6 Evoluzione | 2.8 | 260 | 02.99 - 12.01 | 588 | 6 | 0,9 | DCPR8E | 4339 | | DCPR9EIX | 2316 |
| Quattroporte V8 Evoluzione | 3.2 | 270 | 02.99 - 02 | 578 | 8 | 0,7 | PMR8A | 5851 | | PMR8A | 5851 |
| Racing | 2.0 | 194 | 02.91 - | 475 | 6 | 0,7 | DCPR9E | 2641 | | DCPR9EIX | 2316 |
| Shamal I Turbo 32V | 3.2 | 240 | 02.91 - 02.96 | AM 479 Cat. | 8 | 0,9 | DCPR8E | 4339 | | DCPR9EIX | 2316 |
| Spyder | 2.8 | 165 | 01.90 - | 473 Cat. | 6 | 0,8 | BP8ES | 2912 | | BPR9EIX | 6853 |
| Spyder GT/Cambiocorsa | 4.2 | 287 | 10.01 - 11.03 | F136R | 8 | 0,7 | PMR8A | 5851 | | PMR8A | 5851 |
| Spyder GT/Cambiocorsa | 4.2 | 287 | 12.03 - | F136R | 8 | | PMR8B | 6378 | | PMR9B | 4717 |
| Spyder 16V | 2.0 | 136 | 07.85 - 04.87 | 452 | 6 | 0,8 | BP8ES | 2912 | | BPR9EIX | 6853 |

MATRA

| | | | | | | | | | | | |
|----------------|-----|--|--|--|---|-----|-------|------|---|---------|------|
| Bagheera 1.3S | 1.3 | | | | 4 | 0,8 | BP8ES | 2912 | | BPR9EIX | 6853 |
| Bagheera 1.45X | 1.4 | | | | 4 | 0,8 | BP8ES | 2912 | | BPR9EIX | 6853 |
| Murena 1.6 | 1.6 | | | | 4 | 0,7 | BP6ES | 7811 | 4 | LPG 2 | 1497 |
| Murena 2.2 | 2.2 | | | | 4 | 0,7 | BP6ES | 7811 | 4 | LPG 2 | 1497 |
| Rancho | | | | | 4 | 0,7 | BP6ES | 7811 | 4 | LPG 2 | 1497 |

MAYBACH

| | | | | | | | | | | | |
|----------------------|-----|-----|---------|-----------|----|-----|---------|------|--|---------|------|
| Maybach 57/ 62 (240) | 5.5 | 404 | 09.02 - | M 285.950 | 12 | 0,8 | IFR6Q-G | 5648 | | IFR6Q-G | 5648 |
| Maybach 62S (240) | 6.0 | 450 | 09.05 - | M 285.980 | 12 | 0,8 | IFR6Q-G | 5648 | | IFR6Q-G | 5648 |

MAZDA

| | | | | | | | | | | | |
|-----------------------------|------|-----|------------|-----------------------|---|-----|------------|------|----|------------|------|
| 121 | 1.8 | 44 | 03.96 - | RTJ / RTK | 4 | █ | Y-910R | 4751 | | D-POWER 3 | 3617 |
| 121 DA Fgst 200001→ | 1.3 | 40 | - 96 | B3 Cat. | 4 | 1,1 | BPR6ES-11 | 4824 | 13 | LPG 2 | 1497 |
| 121 DA Fgst→ 200000 | 1.1 | 40 | -03.91 | B1 u.Cat. | 4 | 0,9 | BPR5ES | 7422 | 6 | LPG 2 | 1497 |
| 121 DA Fgst→ 200000 | 1.3 | 44 | 03.96 - | B3 | 4 | 0,9 | BPR5ES | 7422 | 6 | LPG 2 | 1497 |
| 121 DB Fgst 400000→ | 1.3 | 53 | - 96 | B3 16V Cat. | 4 | 1,1 | BKR6E-11 | 2756 | 14 | LPG 1 | 1496 |
| 121 DB Fgst→ 400000 | 1.3 | 39 | - 96 | B3 16V Cat. | 4 | 1,1 | BKR6E-11 | 2756 | 14 | LPG 1 | 1496 |
| 121 ZQ | 1.3 | 37 | 03.96 - | JJA / JJC / JJE / J4C | 4 | 1,0 | PTR5D-10 | 3784 | 31 | LPG 5 | 1516 |
| 121 ZQ | 1.3 | 55 | 03.96 - | DHA Zetec (FORD) | 4 | 1,3 | PTR5A-13 | 2467 | 25 | LPG 4 | 1511 |
| 121 16V | 1.25 | 55 | 00 - 02 | DHB / DHC / DHD / DHF | 4 | 1,3 | PTR5A-13 | 2467 | 25 | LPG 4 | 1511 |
| 2 | 1.3 | 55 | 10.07 - | ZJ-VE / FUJA | 4 | 1,3 | IFR5E13 | 6903 | | | |
| 2 | 1.3 | 63 | 10.07 - | ZJ-VEM / FXJA | 4 | 1,3 | IFR5E13 | 6903 | | | |
| 2 Di Turbo DY Fgst 3*00001→ | 1.4 | 50 | 04.03 - 07 | MZ-CD-SOHC F6JA | 4 | █ | YE04 | 1684 | | D-POWER 40 | 1684 |
| 2 DY Fgst 3*00001→ | 1.25 | 55 | 03 - 07 | MZI FUJA / F8JB | 4 | 1,3 | PTR5A-13 | 2467 | 25 | LPG 4 | 1511 |
| 2 DY Fgst 3*00001→ | 1.25 | 55 | 03 - 07 | MZI FUJB / F8JA | 4 | 1,3 | PTR5A-13 | 2467 | 25 | LPG 4 | 1511 |
| 2 DY Fgst 3*00001→ | 1.3 | 59 | 03 - 07 | MZI DOHC FXJA / FXJB | 4 | 1,3 | PTR5A-13 | 2467 | 25 | LPG 4 | 1511 |
| 2 DY Fgst 3*00001→ | 1.6 | 74 | 03 - 07 | MZI DOHC FYJA | 4 | 1,3 | PTR5A-13 | 2467 | 25 | LPG 4 | 1511 |
| 2 MZ-CD | 1.4 | 50 | 07 - | F6JA | 4 | █ | YE04 | 1684 | | D-POWER 40 | 1684 |
| 2 MZR | 1.5 | 76 | 10.07 - | ZY-VE / FYJA | 4 | 1,3 | IFR5E13 | 6903 | | | |
| 3 (BK) | 1.4 | 59 | 04 - 09 | ZJ | 4 | 1,1 | IFR5E11 | 7994 | | IFR6E11 | 6741 |
| 3 (BK) | 1.6 | 77 | 10.03 - | CE | 4 | 1,1 | BKR5E-11 | 6953 | 33 | LPG 1 | 1496 |
| 3 (BK) | 1.6 | 77 | 10.03 - 09 | Z668 | 4 | 1,1 | IFR5E11 | 7994 | | IFR6E11 | 6741 |
| 3 (BK) | 2.0 | 110 | 10.03 - 09 | LF5... | 4 | 1,3 | ITR6F13 | 4477 | | LPG 5 | 1516 |
| 3 (BL) | 1.6 | 77 | 06.09 - | Z668 | 4 | 1,1 | IFR5E11 | 7994 | | IFR6E11 | 6741 |
| 3 (BL) | 2.0 | 111 | 06.09 - | LF5.. / LFZ:: | 4 | 1,3 | ILTR5A-13G | 3811 | | ILTR6A-13G | 3789 |
| 323 | 1.7 | | | | 4 | █ | CY03 | 6160 | | D-POWER 8 | 6160 |
| 323 | 1.8 | 84 | 02.97 - | B6D | 4 | 1,1 | BKR5E-11 | 6953 | 33 | LPG 1 | 1496 |

Fgst = Chassis No.



ℓ kW

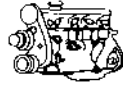

Cyl.

Order-
No.VLINE
No.LPG/CNG
D-PowerOrder-
No.**MAZDA**

| | | | | | | | | | | | |
|---------------------------|-----|-----|-------------|----------------------|---|-----|------------|------|----|------------|------|
| 323 | 1.8 | | 89- | BP DOHC Cat. | 4 | 1,1 | BKR6E-11 | 2756 | 14 | LPG 1 | 1496 |
| 323 | 1.8 | | 89- | BP EGI Cat. | 4 | 0,8 | BKR5E | 7938 | 35 | LPG 1 | 1496 |
| 323 BA Fgst 100001→ | 1.5 | 65 | 09.94- | Z5 Cat. | 4 | 1,1 | BKR5E-11 | 6953 | 33 | LPG 1 | 1496 |
| 323 BA Fgst 300001 → | 1.4 | 54 | 09.94- | B3 | 4 | 1,1 | BKR6E-11 | 2756 | 14 | LPG 1 | 1496 |
| 323 BA Fgst 500001 → | 1.4 | 54 | | B3 16V Cat. | 4 | 1,1 | BKR6E-11 | 2756 | 14 | LPG 1 | 1496 |
| 323 BA Fgst 500001 → | 1.5 | 65 | | Z5 16V Cat. | 4 | 1,1 | BKR6E-11 | 2756 | 14 | LPG 1 | 1496 |
| 323 BD1 Fgst 800000 → | 1.1 | 40 | | E1 | 4 | 0,8 | BPR6ES | 7822 | 2 | LPG 2 | 1497 |
| 323 BD1 Fgst 800000 → | 1.3 | 44 | | E3 | 4 | 0,8 | BPR6ES | 7822 | 2 | LPG 2 | 1497 |
| 323 BD1 Fgst 800000 → | 1.5 | 55 | | E5 | 4 | 0,8 | BPR6ES | 7822 | 2 | LPG 2 | 1497 |
| 323 BF Fgst 400001 → | 1.4 | 44 | | B3 u.Cat. | 4 | 0,8 | BPR6ES | 7822 | 2 | LPG 2 | 1497 |
| 323 BF Fgst 400001 → | 1.5 | 54 | | B5 u.Cat. | 4 | 0,8 | BPR6ES | 7822 | 2 | LPG 2 | 1497 |
| 323 BF Fgst→ 400000 | 1.1 | 40 | | E1 | 4 | 0,8 | BPR6ES | 7822 | 2 | LPG 2 | 1497 |
| 323 BF Fgst→ 400000 | 1.5 | 55 | | E5 | 4 | 0,8 | BPR6ES | 7822 | 2 | LPG 2 | 1497 |
| 323 BG Fgst 500001 → | 1.4 | 54 | | B3 16V Cat. | 4 | 1,1 | BKR6E-11 | 2756 | 14 | LPG 1 | 1496 |
| 323 BG Fgst→ 500000 | 1.4 | 49 | | B3E Cat. | 4 | 1,1 | BPR6ES-11 | 4824 | 13 | LPG 2 | 1497 |
| 323 BG ... | 1.3 | | 90- | B3 Vergaser | 4 | 0,8 | BKR5E | 7938 | 35 | LPG 1 | 1496 |
| 323 BJ Fgst 100001 → | 1.5 | 65 | 09.98- | ZL | 4 | 1,1 | BKR5E-11 | 6953 | 33 | LPG 1 | 1496 |
| 323 BJ Fgst 100001→ | 1.4 | 54 | 09.98- | B3 | 4 | 1,1 | BKR5E-11 | 6953 | 33 | LPG 1 | 1496 |
| 323 BJ Fgst 400001→ | 1.4 | 53 | 02- | B3 SOHC | 4 | 1,1 | BKR5E-11 | 6953 | 33 | LPG 1 | 1496 |
| 323 BJ Fgst 400001→ | 2.0 | 96 | 02- 04 | FS DOHC (High Power) | 4 | 1,1 | ZFR5F-11 | 2262 | | LPG 6 | 1565 |
| 323 BW Fgst→ 400000 | 1.5 | 55 | | E5 | 4 | 0,8 | BPR6ES | 7822 | 2 | LPG 2 | 1497 |
| 323 BW Fgst400001—500000 | 1.5 | 54 | | B5 u.Cat. | 4 | 0,8 | BPR6ES | 7822 | 2 | LPG 2 | 1497 |
| 323 BA Fgst 100001 → | 2.0 | 106 | 09.94-10.98 | KF DOHC V6 | 6 | 1,1 | BKR6E-11 | 2756 | 14 | LPG 1 | 1496 |
| 323 BA Fgst 300001 → | 1.9 | 84 | 09.94- | BP 16V Cat. | 4 | 1,1 | BKR5E-11 | 6953 | 33 | LPG 1 | 1496 |
| 323 BA Fgst 500001 → | 1.9 | 84 | | BP 16V Cat. | 4 | 1,1 | BKR6E-11 | 2756 | 14 | LPG 1 | 1496 |
| 323 BA Fgst 500001 → | 2.0 | 106 | 08.94-10.98 | KF DOHC V6 | 6 | 1,1 | BKR6E-11 | 2756 | 14 | LPG 1 | 1496 |
| 323 BF1 Fgst 400001 → | 1.6 | 63 | | B6 Cat. | 4 | 0,8 | BPR6ES | 7822 | 2 | LPG 2 | 1497 |
| 323 BF1 Fgst 400001 → | 1.6 | 103 | 85- 91 | B6 DOHC Cat. | 4 | 1,1 | BCPR6E-11 | 3132 | 11 | LPG 3 | 1498 |
| 323 BF1 Fgst→ 400000 | 1.6 | 63 | | B6 Cat. | 4 | 1,1 | BPR5ES-11 | 4424 | | LPG 2 | 1497 |
| 323 BF1 Fgst→ 400000 | 1.6 | 77 | | B6 | 4 | 0,8 | BPR6ES | 7822 | 2 | LPG 2 | 1497 |
| 323 BF2 Fgst→ 400000 | 1.6 | 110 | | B6 DOHC | 4 | 0,8 | BCPR6E | 1269 | 12 | LPG 3 | 1498 |
| 323 BG Fgst 500001 → | 1.6 | 65 | | B6 16V Cat. | 4 | 1,1 | BKR6E-11 | 2756 | 14 | LPG 1 | 1496 |
| 323 BG Fgst 500001 → | 1.9 | 76 | | BP SOHC 16V Cat. | 4 | 1,1 | BKR6E-11 | 2756 | 14 | LPG 1 | 1496 |
| 323 BG Fgst 500001 → | 1.9 | 94 | | BP DOHC 16V Cat. | 4 | 1,1 | BKR6E-11 | 2756 | 14 | LPG 1 | 1496 |
| 323 BG Fgst→ 500000 | 1.6 | 62 | | B6E Cat. | 4 | 1,1 | BPR6ES-11 | 4824 | 13 | LPG 2 | 1497 |
| 323 BG Fgst→ 500000 | 1.9 | 76 | | BP SOHC 16V Cat. | 4 | 1,1 | BKR6E-11 | 2756 | 14 | LPG 1 | 1496 |
| 323 BG Fgst→ 500000 | 1.9 | 94 | | BP DOHC 16V Cat. | 4 | 1,1 | BKR6E-11 | 2756 | 14 | LPG 1 | 1496 |
| 323 BG Turbo 16V | 1.9 | 120 | | BP DOHC 16V Cat. | 4 | 1,1 | BKR6E-11 | 2756 | 14 | LPG 1 | 1496 |
| 323 BJ Fgst 100001 → | 1.9 | 84 | 09.98- | FP | 4 | 1,1 | BKR5E-11 | 6953 | 33 | LPG 1 | 1496 |
| 323 BJ Fgst 400001→ | 1.6 | 72 | 02- | ZM DOHC | 4 | | only OES | | | | |
| 323 BW Fgst 500001 → | 1.6 | 63 | | B6 Cat. | 4 | 1,1 | BPR6ES-11 | 4824 | 13 | LPG 2 | 1497 |
| 323 BW Fgst 400001-500000 | 1.6 | 63 | | B6 Cat. | 4 | 1,1 | BPR5ES-11 | 4424 | | LPG 2 | 1497 |
| 323 TD BF→Fgst 300001 | 1.7 | 60 | 99- | 4EE1-T | 4 | █ | CY03 | 6160 | | D-POWER 8 | 6160 |
| 323 Turbo BF2 400001 → | 1.6 | 103 | | B6 DOHC Cat. | 4 | 1,1 | BCPR6E-11 | 3132 | 11 | LPG 3 | 1498 |
| 323 GTR Turbo | 1.8 | 136 | 95- | | 4 | 1,1 | BKR6EVX-11 | 3540 | | LPG 1 | 1496 |
| 323 Turbo | 1.8 | | 89- | BP | 4 | 1,1 | BKR6E-11 | 2756 | 14 | LPG 1 | 1496 |
| 5 | 1.8 | 85 | 06.05- | L8 | 4 | 1,3 | ITR5F-13 | 6044 | | LPG 5 | 1516 |
| 5 | 2.0 | 106 | 06.05- | MZR-LF | 4 | 1,3 | ITR5F-13 | 6044 | | LPG 5 | 1516 |
| 5 | 2.3 | | 05- | L3-VE | 4 | 1,3 | ITR5F-13 | 6044 | | LPG 5 | 1516 |
| 6 | 1.8 | 88 | 09.07- | L823 | 4 | 1,3 | ITR5F-13 | 6044 | | LPG 5 | 1516 |
| 6 | 2.0 | 108 | 09.07- | | 4 | 1,3 | ITR6F13 | 4477 | | LPG 5 | 1516 |
| 6 | 2.0 | | 06.05- | LF-VE | 4 | 1,3 | ILTR5A-13G | 3811 | | ILTR6A-13G | 3789 |

Fgst = Chassis No.



ℓ kW



Cyl.

Order-
No. No.LPG/CNG
D-PowerOrder-
No.**MAZDA**

| | | | | | | | | | | | |
|--------------------------------------|-----|-----|-------------|--------------------|---|-----|------------|------|----|------------|------|
| 6 | 2.3 | 122 | 06.05 - | L3-VE | 4 | 1,3 | ILTR5A-13G | 3811 | | ILTR6A-13G | 3789 |
| 6 GG Fgst 100001→ | 1.8 | 88 | 06.02 - 07 | MZR-L8 DOHC | 4 | 1,3 | ITR6F13 | 4477 | | LPG 5 | 1516 |
| 6 GG Fgst 100001→ | 2.0 | 104 | 06.02 - 07 | MZR-LF17/18 DOHC | 4 | 1,3 | ITR6F13 | 4477 | | LPG 5 | 1516 |
| 6 GG Fgst 100001→ | 2.3 | 122 | 06.02 - 07 | MZR-L3 DOHC | 4 | 1,3 | ITR6F13 | 4477 | | LPG 5 | 1516 |
| 6 Sport-Kombi GY Fgst 100001→ | 1.8 | 88 | 06.02 - 07 | MZR-L8 DOHC | 4 | 1,3 | ITR6F13 | 4477 | | LPG 5 | 1516 |
| 6 Sport-Kombi GY Fgst 100001→ | 2.0 | 104 | 06.02 - 07 | MZR-LF17/18 DOHC | 4 | 1,3 | ITR6F13 | 4477 | | LPG 5 | 1516 |
| 6 Sport-Kombi GY Fgst 100001→ | 2.3 | 122 | 06.02 - 07 | MZR-L3 DOHC | 4 | 1,3 | ITR6F13 | 4477 | | LPG 5 | 1516 |
| 6 Sport-Kombi 4WD GY Fgst 100001→ | 2.3 | 119 | 06.02 - 07 | MZR-L3 DOHC | 4 | 1,3 | ITR6F13 | 4477 | | LPG 5 | 1516 |
| 616 GC Fgst 700001→ | 2.0 | 74 | | FE | 4 | 0,8 | BPR6ES | 7822 | 2 | LPG 2 | 1497 |
| 626 | 1.8 | 66 | - 89 | F8 | 4 | 0,9 | BPR5ES | 7422 | 6 | LPG 2 | 1497 |
| 626 | 1.8 | 66 | 90 - | F8 | 4 | 1,1 | BKR6E-11 | 2756 | 14 | LPG 1 | 1496 |
| 626 | 1.8 | 66 | 90 - | F8 Cat. | 4 | 1,1 | BKR6E-11 | 2756 | 14 | LPG 1 | 1496 |
| 626 | 2.0 | 53 | 11.82-08.85 | RF46 | 4 | | Y-107R | 1229 | | | |
| 626 GC Fgst 650001 → | 1.6 | 59 | | F6 | 4 | 0,8 | BPR6ES | 7822 | 2 | LPG 2 | 1497 |
| 626 GC Fgst 700001→ | 2.0 | 68 | | FE Cat. | 4 | 0,8 | BPR6ES | 7822 | 2 | LPG 2 | 1497 |
| 626 GC Fgst 700001→ | 2.0 | 88 | | FE | 4 | 0,8 | BPR6ES | 7822 | 2 | LPG 2 | 1497 |
| 626 GC Fgst→ 650000 | 1.6 | 59 | | F6 | 4 | 0,8 | BPR6ES | 7822 | 2 | LPG 2 | 1497 |
| 626 GC Fgst→ 700000 | 2.0 | 74 | | FE | 4 | 0,8 | BPR6ES | 7822 | 2 | LPG 2 | 1497 |
| 626 GD Fgst 500001→ | 2.0 | 66 | | FE Cat. | 4 | 0,8 | BPR6ES | 7822 | 2 | LPG 2 | 1497 |
| 626 GD Fgst 500001→ | 2.0 | 103 | | FE 16V Cat. | 4 | 1,1 | BKR6E-11 | 2756 | 14 | LPG 1 | 1496 |
| 626 GD Fgst 500001→ | 2.2 | 85 | | F2 12 Valve Cat. | 4 | 1,1 | ZFR6F-11 | 4291 | | LPG 6 | 1565 |
| 626 GD Fgst→ 500000 | 2.0 | 66 | | FE Cat. | 4 | 1,1 | BPR6ES-11 | 4824 | 13 | LPG 2 | 1497 |
| 626 GD Fgst→ 500000 | 2.0 | 66 | | FE Cat. | 4 | 0,8 | BPR6ES | 7822 | 2 | LPG 2 | 1497 |
| 626 GD Fgst→ 500000 | 2.0 | 79 | | FE 12 Valve | 4 | 0,8 | BCPR6E | 1269 | 12 | LPG 3 | 1498 |
| 626 GD Fgst→ 500000 | 2.0 | 103 | | FE 16V Cat. | 4 | 1,1 | BCPR6E-11 | 3132 | 11 | LPG 3 | 1498 |
| 626 GD Fgst→ 500000 | 2.2 | 85 | | F2 12 Valve Cat. | 4 | 1,1 | ZFR6A-11 | 1041 | | | |
| 626 GE Fgst 100001 → | 1.9 | 77 | 92 - | FP DOHC Cat. | 4 | 1,1 | BKR6E-11 | 2756 | 14 | LPG 1 | 1496 |
| 626 GE Fgst 100001→ | 2.5 | 121 | 92 - 94 | KL DOHC V6 Cat. | 6 | 1,1 | ZFR6F-11 | 4291 | | LPG 6 | 1565 |
| 626 GE Fgst 434202 → | 1.9 | 66 | 09.94 - | FP DOHC | 4 | 1,1 | BKR6E-11 | 2756 | 14 | LPG 1 | 1496 |
| 626 GE Fgst 434202 → | 2.5 | 120 | 09.94 - | KL DOHC V6 | 6 | 1,1 | ZFR5F-11 | 2262 | | LPG 6 | 1565 |
| 626 GE Fgst 4343202→ | 2.0 | 85 | 94 - | FS DOHC Cat. | 4 | 1,1 | BKR6E-11 | 2756 | 14 | LPG 1 | 1496 |
| 626 GF Fgst 100001→ | 1.8 | 66 | 07.97 - | FP DOHC | 4 | 0,8 | PZFR6F | 7550 | | LPG 6 | 1565 |
| 626 GF Fgst 400001→ | 1.9 | 74 | 00 - | FP DOHC | 4 | 0,8 | PZFR6F | 7550 | | LPG 6 | 1565 |
| 626 GF Fgst 400001→ | 2.0 | 85 | 00 - | FS DOHC | 4 | 0,8 | PZFR6F | 7550 | | LPG 6 | 1565 |
| 626 GF Fgst 400001→ | 2.0 | 100 | 00 - | FS DOHC High Power | 4 | 0,8 | PZFR6F | 7550 | | LPG 6 | 1565 |
| 626 GF Fgst.100001 → | 1.9 | 66 | | FP DOHC | 4 | 0,8 | PZFR6F | 7550 | | LPG 6 | 1565 |
| 626 GF Fgst.100001 → | 2.0 | 100 | | FS DOHC | 4 | 0,8 | PZFR6F | 7550 | | LPG 6 | 1565 |
| 626 GF... | 1.9 | 66 | 07.97 - | FP | 4 | 0,8 | PZFR6F | 7550 | | LPG 6 | 1565 |
| 626 GF... | 2.0 | 100 | 07.97 - | FS | 4 | 0,8 | PZFR6F | 7550 | | LPG 6 | 1565 |
| 626 GF... Fgst 100001→ | 2.0 | 85 | | FS DOHC | 4 | 0,8 | PZFR6F | 7550 | | LPG 6 | 1565 |
| 626 GV Fgst 200001 → | 2.0 | 66 | | FE Cat. | 4 | 0,8 | BPR6ES | 7822 | 2 | LPG 2 | 1497 |
| 626 GV Fgst 200001→ | 2.2 | 85 | | F2 12 Valve Cat. | 4 | 1,1 | ZFR6F-11 | 4291 | | LPG 6 | 1565 |
| 626 GV Fgst→ 200000 | 2.0 | 66 | | FE Cat. | 4 | 0,8 | BPR6ES | 7822 | 2 | LPG 2 | 1497 |
| 626 GV Fgst→ 200000 | 2.2 | 85 | | F2 | 4 | 1,1 | ZFR6A-11 | 1041 | | | |
| 626 GW Fgst 100001 → | 1.9 | 66 | | FP DOHC 16V | 4 | 0,8 | PZFR6F | 7550 | | LPG 6 | 1565 |
| 626 GW Fgst 100001 → | 2.0 | 100 | | FS DOHC 16V | 4 | 0,8 | PZFR6F | 7550 | | LPG 6 | 1565 |
| 626 GW Fgst 200001→ | 2.0 | 85 | 00 - | FS DOHC | 4 | 0,8 | PZFR6F | 7550 | | LPG 6 | 1565 |
| 626 GW Fgst 208843→ | 1.9 | 74 | 00 - | FP DOHC | 4 | 0,8 | PZFR6F | 7550 | | LPG 6 | 1565 |

Fgst = Chassis No.



ℓ kW

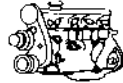

Cyl.

Order-
No.VLINE
No.LPG/CNG
D-PowerOrder-
No.**MAZDA**

| | | | | | | | | | | | |
|--------------------------------|-----|-----|-------------|--------------------|---|-----|------------|------|----|------------|------|
| 626 GW Fgst 208843→ | 2.0 | 100 | 00 - | FS DOHC High Power | 4 | 0,8 | PZFR6F | 7550 | | LPG 6 | 1565 |
| 626 GW Fgst 100001 → | 2.0 | 85 | | FS DOHC 16V | 4 | 0,8 | PZFR6F | 7550 | | LPG 6 | 1565 |
| 626 DIDT GF Fgst 186527→ | 2.0 | 74 | 09.98 - | RF | 4 | █ | Y-529J | 4664 | | | |
| 626 DIDT Kombi GF Fgst 116329→ | 2.0 | 74 | 09.98 - | RF | 4 | █ | Y-529J | 4664 | | | |
| 626(USA)GE Fgst 802219→ | 2.0 | 85 | 92 - 98 | FS DOHC | 4 | 1,1 | BKR5E-11 | 6953 | 33 | LPG 1 | 1496 |
| 626(USA)GE Fgst 803719→ | 2.0 | 85 | | FS DOHC | 4 | 1,1 | BKR5E-11 | 6953 | 33 | LPG 1 | 1496 |
| 929 | 2.0 | | | S 2 | 4 | █ | Y-107T | 1253 | | | |
| 929 | 2.5 | | 92 - | JS-DE | 6 | 1,1 | BKR5EVX-11 | 5182 | | LPG 1 | 1496 |
| 929 HB Fgst 500001→ | 2.0 | 74 | | FE | 4 | 0,8 | BPR6ES | 7822 | 2 | LPG 2 | 1497 |
| 929 HB Fgst 500001→ | 2.0 | 88 | | FE | 4 | 0,8 | BPR6ES | 7822 | 2 | LPG 2 | 1497 |
| 929 HC Fgst 200001→ | 2.2 | 94 | | F2 12Valve Cat. | 4 | 1,1 | ZFR6F-11 | 4291 | | LPG 6 | 1565 |
| 929 HC Fgst 200001→ | 3.0 | 123 | | JE Cat. | 6 | 1,1 | ZFR6F-11 | 4291 | | LPG 6 | 1565 |
| 929 HC Fgst→ 200000 | 2.0 | 85 | | FE without Cat. | 4 | 0,8 | BPR6ES | 7822 | 2 | LPG 2 | 1497 |
| 929 HC Fgst→ 200000 | 2.2 | 85 | | F2 12Valve Cat. | 4 | 1,1 | ZFR6A-11 | 1041 | | | |
| 929 HC Fgst→ 200000 | 2.2 | 100 | | F2 12Val. o.Cat. | 4 | 0,8 | BCPR6E | 1269 | 12 | LPG 3 | 1498 |
| 929 HC Fgst→ 200000 | 3.0 | 125 | | JE Cat. | 6 | 1,1 | ZFR6A-11 | 1041 | | | |
| 929 HC Fgst→ 200000 | 3.0 | 140 | | JE ohne Cat. | 6 | 0,8 | BCPR6E | 1269 | 12 | LPG 3 | 1498 |
| 929 HV Fgst 800001→ | 2.0 | 66 | | MA | 4 | 0,8 | BPR6ES | 7822 | 2 | LPG 2 | 1497 |
| B 1600 | 1.6 | | | | 4 | 0,9 | BPR5ES | 7422 | 6 | LPG 2 | 1497 |
| B 1800 | 1.8 | | | | 4 | 0,9 | BPR5ES | 7422 | 6 | LPG 2 | 1497 |
| B 2000 | 2.0 | | | | 4 | 0,9 | BPR5ES | 7422 | 6 | LPG 2 | 1497 |
| B 2200 | 2.0 | | 08.84 - | F 2 | 4 | █ | Y-107R | 1229 | | | |
| B 2200 | 2.2 | | - 89 | | 4 | 0,9 | BPR5ES | 7422 | 6 | LPG 2 | 1497 |
| B 2200 | 2.2 | | 90 - | F2 | 4 | 0,9 | BPR5ES | 7422 | 6 | LPG 2 | 1497 |
| B 2200 | 2.2 | | 90 - | F2 EGI | 4 | 1,1 | BPR5ES-11 | 4424 | | LPG 2 | 1497 |
| B 2200 | 2.2 | | 01.85-10.96 | R 2 | 4 | █ | Y-107R | 1229 | | | |
| B 2200 | 2.2 | | | S 2 | 4 | █ | Y-107T | 1253 | | | |
| B 2500 UF Fgst 702487→ | 2.5 | 57 | 99 - | WL | 4 | █ | Y-701J | 1566 | | D-POWER 39 | 1566 |
| B 2600 | 2.6 | | - 89 | | 6 | 0,9 | BPR5ES | 7422 | 6 | LPG 2 | 1497 |
| B 2600 | 2.6 | | 90 - | G6 | 6 | 1,1 | ZFR5F-11 | 2262 | | LPG 6 | 1565 |
| B Serie | | | 97 - 11.02 | WLT | | █ | Y-701J | 1566 | | D-POWER 39 | 1566 |
| Demio DW Fgst 300001→ | 1.5 | 55 | 05.00- 03 | B5 SOHC | 4 | 1,1 | BKR6E-11 | 2756 | 14 | LPG 1 | 1496 |
| Demio DW Fgst 300001→ | 1.4 | 46 | 00 - 03 | B3 SOHC | 4 | 1,1 | BKR5E-11 | 6953 | 33 | LPG 1 | 1496 |
| Demio DW Fgst 100.001 → | 1.4 | 46 | 98 - 03 | B3 SOHC | 4 | 1,1 | BKR6E-11 | 2756 | 14 | LPG 1 | 1496 |
| Demio DW Fgst 100.001 → | 1.4 | 53 | 98 - 03 | B3 (High Power) | 4 | 1,1 | BKR6E-11 | 2756 | 14 | LPG 1 | 1496 |
| E 2000 | 2.0 | | 93 - | RF | 4 | █ | Y-107R | 1229 | | | |
| E 2000 SR Fgst 600001→ | 2.0 | 60 | | FE | 4 | 0,9 | BPR5ES | 7422 | 6 | LPG 2 | 1497 |
| E 2000 SR Fgst 700001→ | 2.0 | 70 | 95 - | FE | 4 | 1,1 | BKR6E-11 | 2756 | 14 | LPG 1 | 1496 |
| E 2000 SR Fgst 800001→ | 2.0 | 70 | | FE 8V | 4 | 1,1 | BKR5E-11 | 6953 | 33 | LPG 1 | 1496 |
| E 2000 SR Fgst X100001→ | 2.0 | 70 | 99 - | FE | 4 | 1,1 | BKR5E-11 | 6953 | 33 | LPG 1 | 1496 |
| E 2000 SR Fgst→ 600000 | 2.0 | 63 | 84 - 95 | FE | 4 | 0,8 | BPR6ES | 7822 | 2 | LPG 2 | 1497 |
| E 2200 | 2.2 | | 02.83- 92 | F2 | 4 | █ | Y-107R | 1229 | | | |
| E 2200 | 2.2 | | 93 - 96 | R2 | 4 | █ | Y-107R | 1229 | | | |
| E 3000 | 3.0 | | 93 - | L4DE | | █ | Y-721RS | 3687 | | | |
| E 3000 | 3.0 | | 93 - | VS | | █ | Y-721RS | 3687 | | | |
| E Serie | | | 97 - | R2 | | █ | Y-721RS | 3687 | | | |
| Light Bus Parkway | | | 10.80 - | HA 12V | | █ | Y-107R | 1229 | | | |
| Light Bus Parkway | | | 10.80 - | HA 24V | | █ | Y-157R | 2029 | | | |
| MPV | 2.0 | 100 | 97 - 06.02 | WLT | 4 | █ | Y-701J | 1566 | | D-POWER 39 | 1566 |
| MPV | 2.5 | | 02 - | AJ | 6 | 1,0 | TR5IX | 7397 | | LPG 5 | 1516 |
| MPV LV Fgst 100001→ | 3.0 | 109 | 05.96 - | JE 12V | 6 | 1,1 | BKR6E-11 | 2756 | 14 | LPG 1 | 1496 |
| MPV LV 52 Fgst 631983→ | 3.0 | 113 | 09.94 - | JEE | 6 | 1,1 | ZFR6F-11 | 4291 | | LPG 6 | 1565 |

Fgst = Chassis No.



ℓ kW



Cyl.

Order-
No. No.LPG/CNG
D-PowerOrder-
No.**MAZDA**

| | | | | | | | | | | | |
|-----------------------------------|-----|-----|---------------|---------------------|---|-----|------------|-------|----|------------|------|
| MPV LW Fgst Y100001→ | 2.0 | 90 | 06.99 - 04.02 | FS DOHC | 4 | 1,1 | ZFR5F-11 | 2262 | | LPG 6 | 1565 |
| MPV LW Fgst 200001→ | 2.3 | 104 | 05.02 - | MZR-L3 DOHC | 4 | 1,3 | ITR6F13 | 4477 | | LPG 5 | 1516 |
| MX-3 EC | 1.6 | 65 | 08.91 - | B6 SOHC Cat. | 4 | 1,1 | BKR5E-11 | 6953 | 33 | LPG 1 | 1496 |
| MX-3 EC | 1.8 | 98 | 08.91 - | K8 DOHC Cat. | 6 | 1,1 | BKR5E-11 | 6953 | 33 | LPG 1 | 1496 |
| MX-3 EC Fgst 208015→ | 1.6 | 79 | 94 - | B6 DOHC | 4 | 1,1 | BKR6E-11 | 2756 | 14 | LPG 1 | 1496 |
| MX-3 EC Fgst 208015→ | 1.8 | 95 | 95 - | K8 DOHC | 6 | 1,1 | BKR5E-11 | 6953 | 33 | LPG 1 | 1496 |
| MX-5 | 1.8 | 93 | 06 - | | 4 | 1,3 | ITR5F-13 | 6044 | | LPG 5 | 1516 |
| MX-5 | 2.0 | 118 | 01.06 - | LF-VE | 4 | 1,3 | ILTR6A-13G | 3789 | | ILTR6A-13G | 3789 |
| MX-5 NA Fgst 100000→ | 1.9 | 96 | 94 - | BP DOHC Cat. | 4 | 1,1 | BKR6E-11 | 2756 | 14 | LPG 1 | 1496 |
| MX-5 NA Fgst 100001→ | 1.6 | 85 | 90 - | B6 DOHC Cat. | 4 | 1,1 | BKR6E-11 | 2756 | 14 | LPG 1 | 1496 |
| MX-5 NA Fgst 200001→ | 1.6 | 66 | 95 - | B6 DOHC | 4 | 1,1 | BKR6E-11 | 2756 | 14 | LPG 1 | 1496 |
| MX-5 NA Fgst 308212→ | 1.6 | 66 | | B6 DOHC | 4 | 1,1 | BKR6E-11 | 2756 | 14 | LPG 1 | 1496 |
| MX-5 NA Fgst 308212→ | 1.9 | 96 | | BP DOHC | 4 | 1,1 | BKR6E-11 | 2756 | 14 | LPG 1 | 1496 |
| MX-5 NB Fgst 100001 → | 1.6 | 81 | 98 - | B6 DOHC | 4 | 1,1 | BKR5E-11 | 6953 | 33 | LPG 1 | 1496 |
| MX-5 NB Fgst 100001→ | 1.9 | 103 | 98 - | BP DOHC | 4 | 1,1 | BKR5E-11 | 6953 | 33 | LPG 1 | 1496 |
| MX-5 NB Fgst 121912→ | 1.9 | 103 | 00 - | BP DOHC | 4 | 1,1 | BKR5E-11 | 6953 | 33 | LPG 1 | 1496 |
| (Anniversary) | | | | | | | | | | | |
| MX-5 NB Fgst 200001→ | 1.9 | 107 | 01 - | BP DOHC | 4 | 1,1 | BKR5E-11 | 6953 | 33 | LPG 1 | 1496 |
| MX-5 NB Fgst 300001→ | 1.9 | 102 | 01 - | BP DOHC | 4 | 1,1 | BKR5E-11 | 6953 | 33 | LPG 1 | 1496 |
| Automatic | | | | | | | | | | | |
| MX-6 | 2.2 | | 92 - | F2 | 4 | 1,1 | ZFR6F-11 | 4291 | | LPG 6 | 1565 |
| MX-6 GE Fgst 100001→ | 2.0 | 85 | 92 - | FS DOHC Cat. | 4 | 1,1 | BKR6E-11 | 2756 | 14 | LPG 1 | 1496 |
| MX-6 GE Fgst 100001→ | 2.5 | 121 | 92 - | KL DOHC V6 Cat. | 6 | 1,1 | ZFR5F-11 | 2262 | | LPG 6 | 1565 |
| MX-6 GE Fgst 400001→ | 2.0 | 85 | 09.94 - | FS DOHC | 4 | 1,1 | BKR5E-11 | 6953 | 33 | LPG 1 | 1496 |
| MX-6 GE Fgst 400001→ | 2.5 | 120 | 09.94 - | KL DOHC V6 | 6 | 1,1 | ZFR5F-11 | 2262 | | LPG 6 | 1565 |
| Premacy CP Fgst 100001 →151176 | 1.9 | 74 | | FP DOHC | 4 | 1,1 | BKR5E-11 | 6953 | 33 | LPG 1 | 1496 |
| Premacy CP Fgst 151177→ | 1.9 | 74 | 06.99 - | FP DOHC | 4 | 1,1 | ZFR5F-11 | 2262 | | LPG 6 | 1565 |
| Premacy CP Fgst 300001→ | 2.0 | 96 | | FS DOHC | 4 | 1,1 | BKR5E-11 | 6953 | 33 | LPG 1 | 1496 |
| Premacy CP Fgst 151177→ | 1.9 | 85 | 06.99 - | FP DOHC with VICS | 4 | 1,1 | ZFR5F-11 | 2262 | | LPG 6 | 1565 |
| Ranger | | | | | | | | | | | |
| RX-7 FB Fgst 700001→ | | 83 | | 12 A | | | BR8ET | 4221 | | BR9EIX | 3981 |
| RX-7 FC Fgst→ 200000 | | 110 | | 13 B | | | BR10ET | 7480 | | BR10EIX | 6801 |
| RX-7 Turbo FC Fgst 200001→ | | 147 | 90 - | RE 13 B | | | BUR9EQ | 5483 | | | |
| RX-7 Turbo FC Fgst→200000 | | 133 | | RE 13 B | | 1,0 | SD11A | 1199 | | | |
| RX-7 Turbo FD Fgst→100000 | | 176 | | 13B-REV | | | BUR9EQP | 5255 | | | |
| RX-8 | 2.6 | 141 | 09.03 - 12.10 | 13B-MSP | | | RE8C-L + | 5745+ | | | |
| | | | | 2+2sparkplug | | | RE9B-T | 2809 | | | |
| RX-8 Sport | 2.6 | 170 | 09.03 - 12.10 | 13B-MSP(high power) | | | RE8C-L + | 5745+ | | | |
| | | | | 2+2sparkplug | | | RE9B-T | 2809 | | | |
| T 2500 | 2.5 | | 10.80 - | XA 12V | | | Y-107R | 1229 | | | |
| T 2500 | 2.5 | | 10.80 - | XA 24V | | | Y-157R | 2029 | | | |
| T 3000 | 3.0 | | 93 - | HA | | | Y-771R | 4262 | | | |
| T 3000 | 3.0 | | 10.80 - 92 | HA 12V | | | Y-107R | 1229 | | | |
| T 3000 | 3.0 | | 10.80 - 92 | HA 24V | | | Y-157R | 2029 | | | |
| T 3000 | 3.0 | | 93 - | L4DE | | | Y-771R | 4262 | | | |
| T 4100 | 4.1 | | 10.80 - | ZB 12V | | | Y-107R | 1229 | | | |
| T 4100 | 4.1 | | 10.80 - | ZB 24V | | | Y-157R | 2029 | | | |
| T Serie | | | 97 - | VS | | | Y-771R | 4262 | | | |
| Tribute | 2.0 | | 03 - | Ford | 4 | 1,3 | PTR5A-13 | 2467 | 25 | LPG 4 | 1511 |
| Tribute | 2.3 | 110 | 03 - | MZR-L3 DOHC | 4 | 1,3 | ITR6F13 | 4477 | | LPG 5 | 1516 |
| Tribute EP Fgst M00001→ | 2.0 | 91 | 04.00 - | Zetec 16V | 4 | 1,3 | PTR5A-13 | 2467 | 25 | LPG 4 | 1511 |

Fgst = Chassis No.



ℓ kW



Cyl.

Order-
No.VLINE
No.LPG/CNG
D-PowerOrder-
No.**MAZDA**

| | | | | | | | | | | | |
|-----------------------------|-----|-----|---------|-----------------------|---|-----|----------|------|----|-------|------|
| Tribute EP2 Fgst M00001→ | 2.0 | 91 | 04.00 - | Zetec 16V | 4 | 1,3 | PTR5A-13 | 2467 | 25 | LPG 4 | 1511 |
| Tribute V6 EP Fgst M00001→ | 3.0 | 145 | 04.00 - | Duratec 24V | 6 | 1,0 | TR5IX | 7397 | | LPG 5 | 1516 |
| Tribute V6 EP2 Fgst M00001→ | 3.0 | 145 | 04.00 - | Duratec 24V | 6 | 1,0 | TR5IX | 7397 | | LPG 5 | 1516 |
| Xedos 6 CA Fgst 100001→ | 2.0 | 106 | 06.92 - | | 4 | 1,1 | BKR6E-11 | 2756 | 14 | LPG 1 | 1496 |
| Xedos 6 CA Fgst 210758→ | 1.6 | 79 | 09.94 - | B6 DOHC | 4 | 1,1 | BKR5E-11 | 6953 | 33 | LPG 1 | 1496 |
| Xedos 6 CA Fgst 210758→ | 2.0 | 103 | 09.94 - | KF DOHC V6 | 6 | 1,1 | BKR6E-11 | 2756 | 14 | LPG 1 | 1496 |
| Xedos 9 TA V6 | 2.5 | 120 | 01 - | KJD | 6 | 1,1 | BKR5E-11 | 6953 | 33 | LPG 1 | 1496 |
| Xedos 9 TA Fgst 400001→ | 2.5 | 120 | | KL-V6 DOHC | 6 | 1,1 | ZFR5F-11 | 2262 | | LPG 6 | 1565 |
| Xedos 9 TA Fgst 200001→ | 2.0 | 105 | 10.93 - | KF V6 DOHC | 6 | 1,1 | BKR6E-11 | 2756 | 14 | LPG 1 | 1496 |
| Xedos 9 TA Fgst 200001→ | 2.3 | 155 | 02.95 - | KJ V6 DOHC Miller Mot | 6 | 0,8 | PZFR5F | 3741 | | LPG 6 | 1565 |
| Xedos 9 TA Fgst 200001→ | 2.5 | 128 | 10.93 - | KL-ZE V6 | 6 | 1,1 | ZFR5F-11 | 2262 | | LPG 6 | 1565 |

MERCEDES

| | | | | | | | | | | | |
|-----------------------|-----|-----|--------------|----------------|---|-----|---------|------|----|-----------|------|
| 190 (201) | 2.0 | 63 | 10.82 -05.90 | M 102.921/924 | 4 | | BP6EFS | 3812 | 5 | LPG 5 | 1516 |
| 190 D (201) | 2.0 | 53 | 02.83 -01.89 | OM 601.911 | 4 | ■ | Y-924J | 7906 | | D-POWER 1 | 7906 |
| 190 D (201) | 2.0 | 53 | 02.89 -05.93 | OM 601.911 | 4 | ■ | Y-916J | 5906 | | D-POWER 6 | 5906 |
| 190 D (201) | 2.5 | 66 | 02.89 -05.93 | OM 602.911 | 5 | ■ | Y-916J | 5906 | | D-POWER 6 | 5906 |
| 190 D (201) | 2.5 | 66 | 04.85 -01.89 | OM 602.911 | 5 | ■ | Y-924J | 7906 | | D-POWER 1 | 7906 |
| 190 D (201) | 2.5 | 90 | 02.88 -01.89 | OM 602.961 | 5 | ■ | Y-924J | 7906 | | D-POWER 1 | 7906 |
| 190 D (201) | 2.5 | 90 | 02.89 -05.93 | OM 602.961 | 5 | ■ | Y-916J | 5906 | | D-POWER 6 | 5906 |
| 190 DT (201) | 2.5 | 90 | 02.89 -05.93 | OM 602.961 | 5 | ■ | Y-918J | 6285 | | D-POWER 2 | 6285 |
| 190 E (201) | 2.0 | 87 | 09.85 -08.93 | M 102.962 | 4 | | BP6EFS | 3812 | 5 | LPG 5 | 1516 |
| 190 E (201) | 2.0 | 90 | 10.82 -08.86 | M 102.961/962 | 4 | | BP6EFS | 3812 | 5 | LPG 5 | 1516 |
| 190 E (201) | 2.3 | 97 | 09.86 -05.93 | M 102.985 | 4 | | BP6EFS | 3812 | 5 | LPG 5 | 1516 |
| 190 E (201) | 2.6 | 118 | 09.86 -05.93 | M 103.942 | 6 | | BP6EFS | 3812 | 5 | LPG 5 | 1516 |
| 190 E 1.8 (201) | 1.8 | 80 | 05.90 -05.93 | M 102.910 | 4 | | BP6EFS | 3812 | 5 | LPG 5 | 1516 |
| 190 E 16V (201) | 2.3 | 125 | 04.84 -08.88 | M 102.983 | 4 | | BP7EFVX | 3344 | | | |
| 190 E 16V (201) | 2.5 | 143 | 09.88 -05.93 | M 102.990 | 4 | | BP6EFS | 3812 | 5 | LPG 5 | 1516 |
| 190 E 16V Evo.1 (201) | 2.5 | 143 | 03.89 -04.90 | M 102.991 | 4 | | BP6EFS | 3812 | 5 | LPG 5 | 1516 |
| 190 E 16V Evo.2 (201) | 2.5 | 173 | 05.90 -05.93 | M 102.992 | 4 | | BP6EFS | 3812 | 5 | LPG 5 | 1516 |
| 200 (123) | 2.0 | 74 | 06.80 -11.85 | M 102.920/939 | 4 | | BP6EFS | 3812 | 5 | LPG 5 | 1516 |
| 200 (124) | 2.0 | 77 | 12.84 -05.90 | M 102.922 | 4 | | BP6EFS | 3812 | 5 | LPG 5 | 1516 |
| 200 D (123) | 2.0 | 44 | 08.80 -11.85 | OM 615.940 | 4 | ■ | Y-924J | 7906 | | D-POWER 1 | 7906 |
| 200 D,TD (124) | 2.0 | 53 | 02.89 -06.93 | OM 601.912 | 4 | ■ | Y-916J | 5906 | | D-POWER 6 | 5906 |
| 200 D,TD (124) | 2.0 | 53 | 12.84 -01.89 | OM 601.912 | 4 | ■ | Y-924J | 7906 | | D-POWER 1 | 7906 |
| 200 E (124) | 2.0 | 87 | 12.88 -09.92 | M 102.963 | 4 | | BP6EFS | 3812 | 5 | LPG 5 | 1516 |
| 200 E (124) | 2.0 | 100 | 10.92 -06.93 | M 111.940 | 4 | | BGP6ES | 4930 | 17 | LPG 3 | 1498 |
| 200 GE (463) | 2.0 | 79 | 06.92 -06.95 | M 102.965 | 4 | | BP6EFS | 3812 | 5 | LPG 5 | 1516 |
| 207 D | 2.4 | 53 | 09.82 -09.88 | OM 616. | 4 | ■ | Y-924J | 7906 | | D-POWER 1 | 7906 |
| 208 D | 2.3 | 58 | 10.88 -03.95 | OM 601... | 4 | ■ | Y-916J | 5906 | | D-POWER 6 | 5906 |
| 209 D | 3.0 | 65 | 04.82 -09.88 | OM 617.... | 4 | ■ | Y-924J | 7906 | | D-POWER 1 | 7906 |
| 210 | 2.3 | 70 | 08.82 -08.91 | M 102.942/945 | 4 | 0,8 | BP6EFS | 3812 | 5 | LPG 5 | 1516 |
| 210 | 2.3 | 77 | 08.91 - | M 102. ... | 4 | 0,8 | BP6EFS | 3812 | 5 | LPG 5 | 1516 |
| 210 D | 2.9 | 70 | 10.88 - | OM 602... | 5 | ■ | Y-916J | 5906 | | D-POWER 6 | 5906 |
| 220 E (124) | 2.2 | 110 | 10.92 -06.93 | M 111.960 | 4 | | BGP6ES | 4930 | 17 | LPG 3 | 1498 |
| 230 E (123) | 2.3 | 100 | 04.80 -12.85 | M 102.982 | 4 | | BP6EFS | 3812 | 5 | LPG 5 | 1516 |
| 230 E (124) | 2.3 | 90 | 12.84 -09.92 | M 102.982 | 4 | | BP6EFS | 3812 | 5 | LPG 5 | 1516 |
| 230 E/CE (123) | 2.3 | 100 | 04.80 -12.85 | M 102.980 | 4 | | BP6EFS | 3812 | 5 | LPG 5 | 1516 |
| 230 G (461) | 2.3 | 66 | 04.92 -09.93 | M 115.974 | 4 | | BP5EFS | 3712 | | | |
| 230 G (461) | 2.3 | 79 | 04.92 -09.95 | M 102.958 | 4 | | BP5EFS | 3712 | | | |
| 230 GE (463) | 2.3 | 93 | 09.89 -07.93 | M 102.989 | 4 | | BP6EFS | 3812 | 5 | LPG 5 | 1516 |
| 230 GE (460) | 2.3 | 90 | 05.87 -08.92 | M 102.987 Cat. | 4 | | BP6EFS | 3812 | 5 | LPG 5 | 1516 |

Fgst = Chassis No.



ℓ kW



Cyl.

Order-
No. No.LPG/CNG
D-PowerOrder-
No.**MERCEDES**

| | | | | | | | | | | | |
|----------------------|-----|-----|---------------|----------------|---|---|--------|------|----|------------|------|
| 230 GE (460) | 2.3 | 92 | 04.82 - 08.92 | M 102.981 | 4 | | BP6EFS | 3812 | 5 | LPG 5 | 1516 |
| 230 GE (461) | 2.3 | 90 | 02.93 - 09.95 | M 102.979 | 4 | | BP6EFS | 3812 | 5 | LPG 5 | 1516 |
| 230 GE (461) | 2.3 | 92 | 04.92 - 09.95 | M 102.981 | 4 | | BP6EFS | 3812 | 5 | LPG 5 | 1516 |
| 230 GE (461) | 2.3 | 92 | 06.93 - 09.95 | M 102.996 | 4 | | BP6EFS | 3812 | 5 | LPG 5 | 1516 |
| 230 GE (461) | 2.3 | 92 | 04.92 - 09.95 | M 102.998 | 4 | | BP6EFS | 3812 | 5 | LPG 5 | 1516 |
| 240 D,TD (123) | 2.4 | 46 | 08.80 - 11.84 | OM 616.912 | 4 | ☑ | Y-924J | 7906 | | D-POWER 1 | 7906 |
| 250 D,TD (124) | 2.5 | 66 | 02.89 - 06.93 | OM 602.912 | 5 | ☑ | Y-916J | 5906 | | D-POWER 6 | 5906 |
| 250 D,TD (124) | 2.5 | 66 | 04.85 - 01.89 | OM 602.912 | 5 | ☑ | Y-924J | 7906 | | D-POWER 1 | 7906 |
| 250 DT (124) | 2.5 | 93 | 02.89 - 06.93 | OM 602.962 | 5 | ☑ | Y-916J | 5906 | | D-POWER 6 | 5906 |
| 250 DT (124) | 2.5 | 93 | 09.88 - 01.89 | OM 602.962 | 5 | ☑ | Y-924J | 7906 | | D-POWER 1 | 7906 |
| 250 GD (460) | 2.5 | 69 | 02.89 - 12.92 | OM 602.930 | 5 | ☑ | Y-916J | 5906 | | D-POWER 6 | 5906 |
| 250 GD (460) | 2.5 | 69 | 09.87 - 01.89 | OM 602.930 | 5 | ☑ | Y-924J | 7906 | | D-POWER 1 | 7906 |
| 250 GD (461) | 2.5 | 69 | 04.92 - | OM 602.939 | 5 | ☑ | Y-916J | 5906 | | D-POWER 6 | 5906 |
| 250 GD (463) | 2.5 | 62 | 06.90 - | OM 602.931 | 5 | ☑ | Y-916J | 5906 | | D-POWER 6 | 5906 |
| 260 E (124) | 2.6 | 118 | 09.85 - 09.92 | M 103.940/943 | 6 | | BP6EFS | 3812 | 5 | LPG 5 | 1516 |
| 260 SE (126) | 2.6 | 118 | 09.85 - 06.91 | M 103.941 | 6 | | BP6EFS | 3812 | 5 | LPG 5 | 1516 |
| 280 E (124) | 2.8 | 142 | - 06.95 | M 104.942 | 6 | | BCP6ES | 4930 | 17 | LPG 3 | 1498 |
| 280 GE (461) | 2.8 | 110 | 04.92 - 07.97 | M 110.994 | 6 | | BP6ES | 7811 | 4 | LPG 2 | 1497 |
| 290 GD (461) | 2.9 | 70 | 04.92 - | OM 602.942 | 5 | ☑ | Y-916J | 5906 | | D-POWER 6 | 5906 |
| 290 GDT (461) | 2.9 | 72 | 08.93 - 00.94 | OM 602.942/947 | 6 | ☑ | Y-916J | 5906 | | D-POWER 6 | 5906 |
| 290 GDT (461) | 2.9 | 90 | 07.97 - | OM 602.983 | 5 | ☑ | Y-929U | 1749 | | D-POWER 41 | 1749 |
| 300 D (123) | 3.0 | 59 | 08.80 - 08.81 | OM 617.912 | 5 | ☑ | Y-924J | 7906 | | D-POWER 1 | 7906 |
| 300 D (124) | 3.0 | 80 | 02.89 - 06.93 | OM 603.912 | 6 | ☑ | Y-916J | 5906 | | D-POWER 6 | 5906 |
| 300 D (124) | 3.0 | 80 | 12.84 - 01.89 | OM 603.912 | 6 | ☑ | Y-924J | 7906 | | D-POWER 1 | 7906 |
| 300 D 4-Mat. (124) | 3.0 | 80 | 02.89 - 06.93 | OM 603.913 | 6 | ☑ | Y-916J | 5906 | | D-POWER 6 | 5906 |
| 300 D 4-Mat. (124) | 3.0 | 80 | 09.86 - 01.89 | OM 603.913 | 6 | ☑ | Y-924J | 7906 | | D-POWER 1 | 7906 |
| 300 D,TD (123) | 3.0 | 59 | 08.80 - 11.85 | OM 617.912 | 6 | ☑ | Y-924J | 7906 | | D-POWER 1 | 7906 |
| 300 E (124) | 3.0 | 132 | 09.85 - 09.92 | M 103.983 | 6 | | BP6EFS | 3812 | 5 | LPG 5 | 1516 |
| 300 E (124) | 3.0 | 138 | 01.85 - 08.85 | M 103.980 | 6 | | BP6EFS | 3812 | 5 | LPG 5 | 1516 |
| 300 E 4-Matic (124) | 3.0 | 132 | 09.86 - 06.93 | M 103.985 | 6 | | BP6EFS | 3812 | 5 | LPG 5 | 1516 |
| 300 E-24V (124) | 3.0 | 162 | 09.89 - 06.93 | M 104.980 | 6 | | BCP6ES | 4930 | 17 | LPG 3 | 1498 |
| 300 GD (463) | 3.0 | 83 | 02.89 - 06.93 | OM 603.931 | 6 | ☑ | Y-916J | 5906 | | D-POWER 6 | 5906 |
| 300 GE (463) | 3.0 | 128 | 09.89 - 07.93 | M 103.987 | 6 | | BP6EFS | 3812 | 5 | LPG 5 | 1516 |
| 300 SD (140) | 3.0 | 110 | 02.92 - 04.93 | OM 603.971 | 6 | ☑ | Y-916J | 5906 | | D-POWER 6 | 5906 |
| 300 SE 2.8 (140) | 2.8 | 142 | 02.93 - 10.98 | M 104.944 | 6 | | BCP6ES | 4930 | 17 | LPG 3 | 1498 |
| 300 SE/SEL (126) | 3.0 | 132 | 09.85 - 06.91 | M 103.981 | 6 | | BP6EFS | 3812 | 5 | LPG 5 | 1516 |
| 300 SE/SEL 3,2 (140) | 3.2 | 170 | 03.91 - 06.93 | M 104.990 | 6 | | BCP6ES | 4930 | 17 | LPG 3 | 1498 |
| 300 SED (140) | 3.0 | | 02.91 - 06.93 | | 6 | ☑ | Y-916J | 5906 | | D-POWER 6 | 5906 |
| 300 SL (107) | 3.0 | 132 | 09.85 - 08.89 | M 103.982 | 6 | | BP6EFS | 3812 | 5 | LPG 5 | 1516 |
| 300 SL (129) | 3.0 | 140 | 03.89 - 06.93 | M 103.984 | 6 | | BP6EFS | 3812 | 5 | LPG 5 | 1516 |
| 300 SL-24V (129) | 3.0 | 170 | 07.89 - 06.93 | M 104.981 | 6 | | BCP6ES | 4930 | 17 | LPG 3 | 1498 |
| 300 TD (123) | 3.0 | 92 | 10.80 - 11.85 | OM 617.952 | 5 | ☑ | Y-924J | 7906 | | D-POWER 1 | 7906 |
| 300 TD (124) | 3.0 | 92 | 02.89 - 06.93 | OM 603.960 | 6 | ☑ | Y-916J | 5906 | | D-POWER 6 | 5906 |
| 300 TD (124) | 3.0 | 92 | 12.84 - 01.89 | OM 603.960 | 6 | ☑ | Y-924J | 7906 | | D-POWER 1 | 7906 |
| 300 TD (124) | 3.0 | 108 | 01.88 - 01.89 | OM 603.960 | 6 | ☑ | Y-924J | 7906 | | D-POWER 1 | 7906 |
| 300 TD (124) | 3.0 | 108 | 02.89 - 06.93 | OM 603.960 | 6 | ☑ | Y-916J | 5906 | | D-POWER 6 | 5906 |
| 300 TD (126) | 3.0 | 107 | 11.85 - 12.87 | OM 603.961 | 6 | ☑ | Y-924J | 7906 | | D-POWER 1 | 7906 |
| 300 TD 4Mat. (124) | 3.0 | 105 | 02.89 - 06.93 | OM 603.963 | 6 | ☑ | Y-916J | 5906 | | D-POWER 6 | 5906 |
| 300 TD 4Mat. (124) | 3.0 | 105 | 09.86 - 01.89 | OM 603.963 | 6 | ☑ | Y-924J | 7906 | | D-POWER 1 | 7906 |
| 300 TD SD (126) | 3.0 | 110 | 08.80 - 10.85 | OM 617.951 | 5 | ☑ | Y-924J | 7906 | | D-POWER 1 | 7906 |
| 307 D | 2.4 | 53 | 09.82 - 09.88 | OM 616. | 4 | ☑ | Y-924J | 7906 | | D-POWER 1 | 7906 |
| 308 D | 2.3 | 58 | 10.88 - 03.95 | OM 601. | 4 | ☑ | Y-916J | 5906 | | D-POWER 6 | 5906 |



ℓ kW



Cyl.

Order-
No.VLINE
No.LPG/CNG
D-PowerOrder-
No.**MERCEDES**

| | | | | | | | | | | | | |
|-------------|-------|-----|-----|-------------|-------------------|----|-----|---------|------|----|------------|------|
| 309 | | 2.3 | 77 | 08.82 - | M 102. .. | 4 | 0,8 | BP6EFS | 3812 | 5 | LPG 5 | 1516 |
| 309 D | | 3.0 | 65 | 04.82-09.88 | OM 617. | 4 | █ | Y-924J | 7906 | | D-POWER 1 | 7906 |
| 310 | | 2.3 | 70 | 08.82-08.91 | M 102.942/945 | 4 | 0,8 | BP6EFS | 3812 | 5 | LPG 5 | 1516 |
| 310 | | 2.3 | 77 | 08.91 - | M 102. .. | 4 | 0,8 | BP6EFS | 3812 | 5 | LPG 5 | 1516 |
| 310 D | | 2.9 | 70 | 10.88 - | OM 602. | 5 | █ | Y-916J | 5906 | | D-POWER 6 | 5906 |
| 320 E | (124) | 3.2 | 162 | 10.92-06.93 | M 104.992 | 6 | | BCP6ES | 4930 | 17 | LPG 3 | 1498 |
| 350 D | (126) | 3.5 | 115 | 02.89-06.91 | OM 603. | 6 | █ | Y-916J | 5906 | | D-POWER 6 | 5906 |
| 350 D,TD | (126) | 3.5 | 100 | 03.90-06.91 | OM 603.970 | 6 | █ | Y-916J | 5906 | | D-POWER 6 | 5906 |
| 350 GD | (463) | 3.5 | 100 | 09.91-06.93 | OM 603.972 | 6 | █ | Y-916J | 5906 | | D-POWER 6 | 5906 |
| 380 SL/SLC | (107) | 3.8 | 160 | 07.80-08.85 | M 116.960/962 | 8 | | BP6ES | 7811 | 4 | LPG 2 | 1497 |
| 380 SL/SLC | (107) | 3.8 | 160 | 07.80-08.85 | M 116.982 | 8 | | BP6ES | 7811 | 4 | LPG 2 | 1497 |
| 380 SL/SLC | (107) | 3.8 | 160 | 07.80-08.85 | M 116.992 | 8 | | BP6ES | 7811 | 4 | LPG 2 | 1497 |
| 400 E | (124) | 4.2 | 205 | 10.92-06.93 | M 119.975 | 8 | | BCP6ES | 4930 | 17 | LPG 3 | 1498 |
| 400 SE/SEL | (140) | 4.2 | 210 | 02.91-06.93 | M 119.971 | 8 | | BCP6ES | 4930 | 17 | LPG 3 | 1498 |
| 407 D | | 2.4 | 53 | 07.81-09.88 | OM 616. | 4 | █ | Y-924J | 7906 | | D-POWER 1 | 7906 |
| 408 D | | 2.3 | 58 | 10.88 - | OM 601. | 4 | █ | Y-916J | 5906 | | D-POWER 6 | 5906 |
| 409 D | | 3.0 | 65 | 04.82-08.88 | OM 617. | 4 | █ | Y-924J | 7906 | | D-POWER 1 | 7906 |
| 410 | | 2.3 | 70 | 08.82-08.91 | M 102.942/943/945 | 4 | 0,8 | BP6EFS | 3812 | 5 | LPG 5 | 1516 |
| 410 | | 2.3 | 77 | 08.91 - | M 102. .. | 4 | 0,8 | BP6EFS | 3812 | 5 | LPG 5 | 1516 |
| 410 D | | 2.9 | 70 | 10.88 - | OM 602. | 5 | █ | Y-916J | 5906 | | D-POWER 6 | 5906 |
| 420 | (126) | 4.2 | 150 | 09.85-06.91 | M 116.965 | 8 | | BP6ES | 7811 | 4 | LPG 2 | 1497 |
| 420 SL | (107) | 4.2 | 150 | 01.86-08.89 | M 116.964 | 8 | | BP6ES | 7811 | 4 | LPG 2 | 1497 |
| 500 E | (124) | 5.0 | 235 | 06.91-06.93 | M 119.974 | 8 | | BCP6ES | 4930 | 17 | LPG 3 | 1498 |
| 500 SE/SEL | (140) | 5.0 | 240 | 02.91-06.93 | M 119.970 | 8 | | BCP6ES | 4930 | 17 | LPG 3 | 1498 |
| 500 SEC | (140) | 5.0 | 240 | 10.92-06.93 | M 119.970 | 8 | | BCP6ES | 4930 | 17 | LPG 3 | 1498 |
| 500 SL | (107) | 5.0 | 164 | 03.80-08.89 | M 117.964 | 8 | | BP6ES | 7811 | 4 | LPG 2 | 1497 |
| 500 SL | (129) | 5.0 | 235 | 09.92-06.93 | M 119.972 | 8 | | BCP6ES | 4930 | 17 | LPG 3 | 1498 |
| 500 SL | (129) | 5.0 | 240 | 03.89-06.93 | M 119.960 | 8 | | BCP6ES | 4930 | 17 | LPG 3 | 1498 |
| 500 SLC | (107) | 5.0 | 177 | 03.80-09.81 | M 117.960 | 8 | | BP6ES | 7811 | 4 | LPG 2 | 1497 |
| 507 D | | 2.4 | 53 | 04.82-09.88 | OM 616. | 4 | █ | Y-924J | 7906 | | D-POWER 1 | 7906 |
| 508 D | | 2.3 | 58 | 03.89 - | OM 601. | 4 | █ | Y-916J | 5906 | | D-POWER 6 | 5906 |
| 510 | | 2.3 | 70 | 08.82-08.91 | M 102.946 | 4 | 0,8 | BP6EFS | 3812 | 5 | LPG 5 | 1516 |
| 510 | | 2.3 | 77 | 08.91 - | M 102. .. | 4 | 0,8 | BP6EFS | 3812 | 5 | LPG 5 | 1516 |
| 560 | (126) | 5.6 | 178 | 09.87-06.91 | M 117.968 | 8 | | BP6ES | 7811 | 4 | LPG 2 | 1497 |
| 600 SE/SEL | (140) | 6.0 | 290 | 04.91-06.93 | M 120.980 | 12 | | BCP6ES | 4930 | 17 | LPG 3 | 1498 |
| 600 SEC | (140) | 6.0 | 290 | 10.92-06.93 | M 120.980 | 12 | | BCP6ES | 4930 | 17 | LPG 3 | 1498 |
| 600 SL | (129) | 6.0 | 290 | 07.92-06.93 | M 120.981 | 12 | | BCP6ES | 4930 | 17 | LPG 3 | 1498 |
| A 140 | (168) | 1.4 | 60 | 10.97 - | M 166.940 | 4 | | BKUR5ET | 2789 | 29 | LPG 1 | 1496 |
| A 140 | (168) | 1.6 | 60 | 01.01 - | M 166.960 | 4 | | BKUR5ET | 2789 | 29 | LPG 1 | 1496 |
| A 150 | (169) | 1.5 | 70 | 09.04 - | M 266.920 | 4 | | BKR6EZB | 4293 | | | |
| A 160 | (168) | 1.6 | 75 | 10.97 - | M 166.960 | 4 | | BKUR5ET | 2789 | 29 | LPG 1 | 1496 |
| A 160 CDi | (168) | 1.7 | 44 | 10.97-02.01 | OM 668.941 | 4 | █ | Y-746R | 4842 | | D-POWER 38 | 3078 |
| A 160 CDi | (168) | 1.7 | 55 | 02.01 - | OM 668.940 | 4 | █ | Y-746R | 4842 | | D-POWER 38 | 3078 |
| A 160 CDi | (169) | 2.0 | 60 | 09.04 - | OM 640.942 | 4 | █ | Y8002AS | 6287 | | D-POWER 51 | 6287 |
| A 170 | (169) | 1.7 | 85 | 09.04 - | M 266.940 | 4 | | BKR6EZB | 4293 | | | |
| A 170 CDi | (168) | 1.7 | 66 | 08.98-02.01 | OM 668.940 | 4 | █ | Y-746R | 4842 | | D-POWER 38 | 3078 |
| A 170 CDi | (168) | 1.7 | 70 | 02.01 - | OM 668.942 | 4 | █ | Y-746R | 4842 | | D-POWER 38 | 3078 |
| A 180 CDi | (169) | 2.0 | 80 | 09.04 - | OM 640.940 | 4 | █ | Y8002AS | 6287 | | D-POWER 51 | 6287 |
| A 190 | (168) | 1.9 | 92 | 03.99 - | M 166.990 | 4 | | BKUR5ET | 2789 | 29 | LPG 1 | 1496 |
| A 200 | (169) | 2.0 | 100 | 09.04 - | M 266.960 | 4 | | BKR6EZB | 4293 | | | |
| A 200 Turbo | (169) | 2.0 | 142 | 06 - | M 266.980 | 4 | | IFR6D10 | 5344 | | LPG 1 | 1496 |
| A 200 CDi | (169) | 2.0 | 103 | 09.04 - | OM 640.941 | 4 | █ | Y8002AS | 6287 | | D-POWER 51 | 6287 |



ℓ kW



Cyl.

Order-
No. No.

VALVE

LPG/CNG
D-PowerOrder-
No.**MERCEDES**

| | | | | | | | | | | | | | | |
|-----------------------------------|-----|-----|---------------|-----------------------|---|---|------------|------|----|----|----|----|------------|------|
| A 210 Evolution (168) | 2.0 | 103 | 03.02 - | M 166.995 | 4 | | BKUR5ET | 2789 | 29 | 29 | 29 | 29 | LPG 1 | 1496 |
| B 150 (245) | 1.5 | 70 | 04.05 - | M 266.920 | 4 | | BKR6EZB | 4293 | | | | | | |
| B 170 (245) | 1.7 | 85 | 04.05 - | M 266.940 | 4 | | BKR6EZB | 4293 | | | | | | |
| B 180 CDI (245) | 2.0 | 80 | 04.05 - | OM 640.940 | 4 | ▣ | Y8002AS | 6287 | | | | | D-POWER 51 | 6287 |
| B 200 (245) | 2.0 | 100 | 04.05 - | M 266.960 | 4 | | BKR6EZB | 4293 | | | | | | |
| B 200 CDI (245) | 2.0 | 103 | 04.05 - | OM 640.941 | 4 | ▣ | Y8002AS | 6287 | | | | | D-POWER 51 | 6287 |
| B 200 Turbo (245) | 2.0 | 142 | 04.05 - | M 266.980 | 4 | | IFR6D10 | 5344 | | | | | LPG 1 | 1496 |
| C 160 Kompressor (203) | 1.8 | 90 | 05.02 - 11.06 | M 271.921 -> 30853899 | 4 | | ILFR6A | 3588 | | | | | ILFR6A | 3588 |
| C 180 (202) | 1.8 | 90 | 06.93 - 06.97 | M 111.920 | 4 | | BCP6ES | 4930 | 17 | | | | LPG 3 | 1498 |
| C 180 (202) | 1.8 | 90 | 07.97 - 05.00 | M 111.921 | 4 | | BKUR5ET | 2789 | 29 | | | | LPG 1 | 1496 |
| C 180 (202) | 1.8 | 95 | 09.00 - 03.01 | M 111.952 | 4 | | IFR6D10 | 5344 | | | | | LPG 1 | 1496 |
| C 180 (203) | 2.0 | 95 | 05.00 - 05.02 | M 111.951 | 4 | | IFR6D10 | 5344 | | | | | LPG 1 | 1496 |
| C 180 D (202) | 1.8 | 65 | 10.98 - 05.00 | OM 604. | 4 | ▣ | Y-925J | 6848 | | | | | D-POWER 16 | 6848 |
| C 180 Kompressor (203) | 1.8 | 105 | 05.02 - 11.06 | M 271.940 -> 30853899 | 4 | | ILFR6A | 3588 | | | | | ILFR6A | 3588 |
| C 180 Kompressor (203) | 1.8 | 105 | 05.02 - 11.06 | M 271.946 -> 30853899 | 4 | | ILFR6A | 3588 | | | | | ILFR6A | 3588 |
| C 180 Kompressor ECO (204) | 1.6 | 115 | 01.08 - | M 271.910 | 4 | | PLKR7A | 4288 | | | | | PLKR7A | 4288 |
| C 200 (202) | 2.0 | 100 | 03.94 - 06.97 | M 111.941 | 4 | | BCP6ES | 4930 | 17 | | | | LPG 3 | 1498 |
| C 200 (202) | 2.0 | 100 | 07.97 - 05.00 | M 111.945 | 4 | | BKUR5ET | 2789 | 29 | | | | LPG 1 | 1496 |
| C 200 (202) | 2.0 | 120 | 09.00 - 03.01 | M 111.956 | 4 | | IFR6D10 | 5344 | | | | | LPG 1 | 1496 |
| C 200 CDI (202) | 2.2 | 75 | 03.98 - 05.00 | OM 611.960 | 4 | ▣ | Y-745U | 6346 | | | | | D-POWER 11 | 6346 |
| C 200 CDI (203) | 2.2 | 85 | 05.00 - | OM 611.962 | 4 | ▣ | Y-745U | 6346 | | | | | D-POWER 11 | 6346 |
| C 200 CDI (203) | 2.2 | 90 | 04.03 - | OM 646.962 | 4 | ▣ | Y-745U | 6346 | | | | | D-POWER 11 | 6346 |
| C 200 CDI (204) | 2.2 | 100 | 08.07 - | OM 646.811 | 4 | ▣ | CZ106 | 9957 | | | | | D-POWER 53 | 9957 |
| C 200 CDI ECO (204) | 2.2 | | 10.07 - | OM 646.812 | 4 | ▣ | CZ106 | 9957 | | | | | D-POWER 53 | 9957 |
| C 200 CGI Kompressor (203) | 1.8 | 125 | 02.03 - 11.06 | M 271.942 -> 30853899 | 4 | | ILFR6A | 3588 | | | | | ILFR6A | 3588 |
| C 200 D (202) | 2.0 | 55 | 07.93 - 05.00 | OM 601.913 | 4 | ▣ | Y-916J | 5906 | | | | | D-POWER 6 | 5906 |
| C 200 D (202) | 2.0 | 65 | 10.96 - 05.00 | OM 604.915 | 4 | ▣ | Y-925J | 6848 | | | | | D-POWER 16 | 6848 |
| C 200 Kompressor (202) | 2.0 | 132 | 09.95 - 10.96 | M 111.944 | 4 | | BKUR6ET-10 | 2397 | 24 | | | | LPG 1 | 1496 |
| C 200 Kompressor (202) | 2.0 | 141 | 11.96 - 05.00 | M 111.944 | 4 | | BKUR6ET-10 | 2397 | 24 | | | | LPG 1 | 1496 |
| C 200 Kompressor (203) | 1.8 | 105 | 02.03 - 11.06 | M 271.942 -> 30853899 | 4 | | ILFR6A | 3588 | | | | | ILFR6A | 3588 |
| C 200 Kompressor (203) | 1.8 | 120 | 02.03 - 11.06 | M 271.940 -> 30853899 | 4 | | ILFR6A | 3588 | | | | | ILFR6A | 3588 |
| C 200 Kompressor (203) | 2.0 | 120 | 05.00 - | M 111.955 | 4 | | IFR6D10 | 5344 | | | | | LPG 1 | 1496 |
| C 220 (202) | 2.2 | 110 | 06.93 - 09.96 | M 111.961 | 4 | | BCP6ES | 4930 | 17 | | | | LPG 3 | 1498 |
| C 220 CDI (202) | 2.2 | 75 | 06.98 - 05.00 | OM 611.961 | 4 | ▣ | Y-745U | 6346 | | | | | D-POWER 11 | 6346 |
| C 220 CDI (202) | 2.2 | 92 | 09.97 - 05.00 | OM 611.960 | 4 | ▣ | Y-745U | 6346 | | | | | D-POWER 11 | 6346 |
| C 220 CDI (203) | 2.2 | 105 | 05.00 - | OM 611.962 | 4 | ▣ | Y-745U | 6346 | | | | | D-POWER 11 | 6346 |
| C 220 CDI (203) | 2.2 | 110 | 05.02 - | OM 646.963 | 4 | ▣ | Y-745U | 6346 | | | | | D-POWER 11 | 6346 |
| C 220 CDI (204) | 2.2 | 125 | 05.07 - | OM 646.811 | 4 | ▣ | CZ106 | 9957 | | | | | D-POWER 53 | 9957 |
| C 220 D (202) | 2.2 | 70 | 06.95 - 05.00 | OM 604.910 | 4 | ▣ | Y-925J | 6848 | | | | | D-POWER 16 | 6848 |
| C 220 D (202) | 2.2 | 70 | 07.93 - 05.95 | OM 604.910 | 4 | ▣ | ◆ Y-930U § | 4275 | | | | | D-POWER 30 | 4275 |
| C 230 (202) | 2.3 | 110 | 09.96 - 05.97 | M 111.974 | 4 | | BCP6ES | 4930 | 17 | | | | LPG 3 | 1498 |
| C 230 (203) | 2.5 | 150 | 12.04 - | M 272.920 | 6 | | PLKR7A | 4288 | | | | | PLKR7A | 4288 |
| C 230 (204) | 2.5 | 150 | 08.07 - | M 272.921 | 6 | | PLKR7A | 4288 | | | | | PLKR7A | 4288 |
| C 230 4-matic (204) | 2.5 | 150 | 01.07 - | M 272.911 | 6 | | PLKR7A | 4288 | | | | | PLKR7A | 4288 |
| C 230 Kompressor (202) | 2.3 | 142 | 10.95 - 05.00 | M 111.975 | 4 | | BKUR6ET-10 | 2397 | 24 | | | | LPG 1 | 1496 |
| C 230 Kompressor (203) | 1.8 | 141 | 02.04 - 11.06 | M 271.948 -> 30853899 | 4 | | ILFR6A | 3588 | | | | | ILFR6A | 3588 |
| C 230 Kompressor (203) | 2.3 | 145 | 03.01 - 05.02 | M 111.981 | 4 | | IFR6D10 | 5344 | | | | | LPG 1 | 1496 |
| C 240 (203) | 2.6 | 125 | 05.00 - | M 112.912 Twin Spark | 6 | | PFR5R-11 | 4292 | | | | | LPG 1 | 1496 |
| C 240 4-Matic (203) | 2.6 | 125 | 07.02 - | M 112.916 Twin Spark | 6 | | PFR5R-11 | 4292 | | | | | LPG 1 | 1496 |
| C 240 V6 (202) | 2.4 | 125 | 04.97 - 05.00 | M 112.910 Twin Spark | 6 | | PFR5R-11 | 4292 | | | | | LPG 1 | 1496 |
| C 240 V6 (202) | 2.6 | 125 | 09.00 - 03.01 | M 112.915 Twin Spark | 6 | | PFR5R-11 | 4292 | | | | | LPG 1 | 1496 |
| C 250 CDI (204) | 2.2 | 150 | 01.08 - | OM 651.911 | 4 | ▣ | CZ303 | 7865 | | | | | D-POWER 54 | 7865 |





ℓ kW

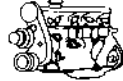

Cyl.

Order-
No.VLINE
No.LPG/CNG
D-PowerOrder-
No.**MERCEDES**

| | | | | | | | | | | |
|--------------------------------|-----|-----|-------------|-----------------------|----|------------|------|----|------------|------|
| C 250 D (202) | 2.5 | 83 | 02.95-08.95 | OM 605.910 | 5 | Y-925J | 6848 | | D-POWER 16 | 6848 |
| C 250 D (202) | 2.5 | 83 | 07.93-01.95 | OM 605.910 | 5 | Y-930U § | 4275 | | D-POWER 30 | 4275 |
| C 250 Td (202) | 2.5 | 110 | 05.96-05.00 | OM 605.960 | 5 | Y-925J | 6848 | | D-POWER 16 | 6848 |
| C 270 CDI (203) | 2.7 | 125 | 12.00- | OM 612.962 | 5 | Y-745U | 6346 | | D-POWER 11 | 6346 |
| C 280 (202) | 2.8 | 141 | 06.93-05.97 | M 104.941 | 6 | BCP6ES | 4930 | 17 | LPG 3 | 1498 |
| C 280 (203) | 3.0 | 170 | 11.04- | M 272.940 | 6 | PLKR7A | 4288 | | PLKR7A | 4288 |
| C 280 (204) | 3.0 | 170 | 05.07- | M 272.947 | 6 | PLKR7A | 4288 | | PLKR7A | 4288 |
| C 280 4-Matic (203) | 3.0 | 170 | 02.05- | M 272.941 | 6 | PLKR7A | 4288 | | PLKR7A | 4288 |
| C 280 4-Matic (204) | 3.0 | 170 | 05.07- | M 272.948 | 6 | PLKR7A | 4288 | | PLKR7A | 4288 |
| C 280 V6 (202) | 2.8 | 145 | 06.97-05.00 | M 112.920 Twin Spark | 6 | PFR5R-11 | 4292 | | LPG 1 | 1496 |
| C 32 AMG Kompressor (203) | 3.2 | 260 | 00- | M 112.961 Twin Spark | 6 | IFR6D10 | 5344 | | LPG 1 | 1496 |
| C 320 (203) | 3.2 | 160 | 05.00- | M 112.946 Twin Spark | 6 | PFR5R-11 | 4292 | | LPG 1 | 1496 |
| C 320 4-Matic (203) | 3.2 | 160 | 07.02- | M 112.953 Twin Spark | 6 | PFR5R-11 | 4292 | | LPG 1 | 1496 |
| C 320 CDI (203) | 3.0 | 165 | 12.04- | OM 642.910 | 6 | Y8002AS | 6287 | | D-POWER 51 | 6287 |
| C 320 CDI (204) | 3.0 | 165 | 07.07- | OM 642.960 | 6 | Y8002AS | 6287 | | D-POWER 51 | 6287 |
| C 320 CDI 4-matic (204) | 3.0 | 165 | 07- | OM 642.961 | 6 | Y8002AS | 6287 | | D-POWER 51 | 6287 |
| C 350 (203) | 3.5 | 200 | 12.04- | M 272.960 | 6 | PLKR7A | 4288 | | PLKR7A | 4288 |
| C 350 (204) | 3.5 | 200 | 05.07- | M 272.961 | 6 | PLKR7A | 4288 | | PLKR7A | 4288 |
| C 350 4-Matic (203) | 3.5 | 200 | 12.04- | M 272.970 | 6 | PLKR7A | 4288 | | PLKR7A | 4288 |
| C 350 4-Matic (204) | 3.5 | 200 | 05.07- | M 272.971 | 6 | PLKR7A | 4288 | | PLKR7A | 4288 |
| C 350 CGI (204) | 3.5 | | 08- | M 272.982 | 6 | SILZKR7A-S | 7718 | | SILZKR7A-S | 7718 |
| C 350 CDI 4-Matic (204) | 3.0 | 165 | 04.09- | OM 642.832 | 6 | CZ303 | 7865 | | D-POWER 54 | 7865 |
| C 350 CDI BlueEfficiency (204) | 3.0 | 170 | 09.09- | OM 642.830 | 6 | CZ303 | 7865 | | D-POWER 54 | 7865 |
| C 36 AMG (202) | 3.6 | 206 | 01.94-05.97 | M 104.941 | 6 | BKR5EKU | 3964 | | | |
| C 43 AMG (202) | 4.3 | 225 | 09.97-05.00 | M 113.944 Twin Spark | 8 | PFR5R-11 | 4292 | | LPG 1 | 1496 |
| C 55 AMG (203) | 5.4 | 270 | 02.04- | M 113.988 Twin Spark | 8 | IFR6D10 | 5344 | | LPG 1 | 1496 |
| C 63 AMG (204) | 6.3 | 336 | 08.07- | M 156.985 | 8 | ILZKAR7A10 | 6043 | | ILZKAR7A10 | 6043 |
| CL 420 (140) | 4.2 | 205 | 06.96-06.97 | M 119.981 | 8 | BCP6ES | 4930 | 17 | LPG 3 | 1498 |
| CL 420 (140) | 4.2 | 205 | 07.97-10.98 | M 119.981 | 8 | PFR5R-11 | 4292 | | LPG 1 | 1496 |
| CL 500 (140) | 5.0 | 235 | 07.97-10.98 | M 119.980 | 8 | PFR5R-11 | 4292 | | LPG 1 | 1496 |
| CL 500 (140) | 5.0 | 235 | 09.96-06.97 | M 119.980 | 8 | PFR5R-11 | 4292 | | LPG 1 | 1496 |
| CL 500 (215) | 5.0 | 225 | 09.00-03.06 | M 113.960 Twin Spark | 8 | PFR5R-11 | 4292 | | LPG 1 | 1496 |
| CL 500 (216) | 5.5 | 286 | 10.06- | M 273.961 | 8 | PLKR7A | 4288 | | PLKR7A | 4288 |
| CL 55 AMG (215) | 5.5 | 265 | 10.99-03.06 | M 113.986 Twin Spark | 8 | PFR5R-11 | 4292 | | LPG 1 | 1496 |
| CL 55 AMG Kompressor (215) | 5.5 | 386 | 00-03.06 | M 113.991 Twin Spark | 8 | ILFR6A | 3588 | | ILFR6A | 3588 |
| CL 600 (140) | 6.0 | 290 | 06.96-05.97 | M 120.982 | 12 | BCP6ES | 4930 | 17 | LPG 3 | 1498 |
| CL 600 (215) | 6.0 | 270 | 03.99-03.06 | M 137.970 Twin Spark | 12 | IFR6Q-G | 5648 | | IFR6Q-G | 5648 |
| CL 600 (215) | 6.0 | 368 | 02-03.06 | M 275.950 Twin Spark | 12 | IFR6Q-G | 5648 | | IFR6Q-G | 5648 |
| CL 600 (216) | 6.0 | 381 | 09.06- | M 275.953 Twin Spark | 12 | IFR6Q-G | 5648 | | IFR6Q-G | 5648 |
| CL 600 (140) | 6.0 | 290 | 06.97-10.98 | M 120.982 | 12 | PFR5R-11 | 4292 | | LPG 1 | 1496 |
| CL 63 AMG (216) | 6.3 | 386 | 09.06- | M 156.984 | 8 | ILZKAR7A10 | 6043 | | ILZKAR7A10 | 6043 |
| CL 65 AMG (215) | 6.0 | 450 | 09.03-03.06 | M 275.980 Twin Spark | 12 | IFR6Q-G | 5648 | | IFR6Q-G | 5648 |
| CL 65 AMG (216) | 6.0 | 450 | 10.06- | M 275.982 Twin Spark | 12 | IFR6Q-G | 5648 | | IFR6Q-G | 5648 |
| CLC 180 Kompressor (203) | 1.8 | 105 | 05.08- | M 271.940 -> 30853899 | 4 | ILFR6A | 3588 | | ILFR6A | 3588 |
| CLC 180 Kompressor (203) | 1.8 | 105 | 05.08- | M 271.946 -> 30853899 | 4 | ILFR6A | 3588 | | ILFR6A | 3588 |
| CLC 200 CDI (203) | 2.2 | 90 | 05.08- | OM 646.962 | 4 | Y-745U | 6346 | | D-POWER 11 | 6346 |
| CLC 220 CDI (203) | 2.2 | 110 | 05.08- | OM 646.963 | 4 | Y-745U | 6346 | | D-POWER 11 | 6346 |
| CLC 230 (203) | 2.5 | 150 | 05.08- | M 272.920 | 6 | PLKR7A | 4288 | | PLKR7A | 4288 |
| CLC 350 (203) | 3.5 | 200 | 05.08- | M 272.960 | 6 | PLKR7A | 4288 | | PLKR7A | 4288 |
| CLK 200 (208) | 2.0 | 100 | 06.97- 02 | M 111.945 | 4 | BKUR5ET | 2789 | 29 | LPG 1 | 1496 |
| CLK 200 CGI (209) | 1.8 | 125 | 02.03-11.06 | M 271.942 -> 30853899 | 4 | ILFR6A | 3588 | | ILFR6A | 3588 |
| CLK 200 Kompressor (208) | 2.0 | 120 | 06.00-06.02 | M 111.956 | 4 | IFR6D10 | 5344 | | LPG 1 | 1496 |





l kW



Cyl.



Order-
No. No.



LPG/CNG
D-Power

Order-
No.

MERCEDES

| | | | | | | | | | | | |
|--------------------------------|-----|-----|---------------|-----------------------|---|---|------------|------|----|------------|------|
| CLK 200 Kompressor (208) | 2.0 | 135 | 07.97 - 02 | M 111.944 | 4 | | BKUR6ET-10 | 2397 | 24 | LPG 1 | 1496 |
| CLK 200 Kompressor (209) | 1.8 | 120 | 09.02 - 11.06 | M 271.940 -> 30853899 | 4 | | ILFR6A | 3588 | | ILFR6A | 3588 |
| CLK 220 CDI (209) | 2.2 | 110 | 01.05 - | OM 646.963 | 4 | █ | Y-745U | 6346 | | D-POWER 11 | 6346 |
| CLK 220 CDI (209) | 2.2 | 110 | 01.05 - | OM 646.966 | 4 | █ | Y-745U | 6346 | | D-POWER 11 | 6346 |
| CLK 230 Kompressor (208) | 2.3 | 142 | 06.97 - 02.00 | M 111.975 | 4 | | BKUR6ET-10 | 2397 | 24 | LPG 1 | 1496 |
| CLK 230 Kompressor (208) | 2.3 | 145 | 03.00 - 06.02 | M 111.982 | 4 | | IFR6D10 | 5344 | | LPG 1 | 1496 |
| CLK 240 (209) | 2.6 | 125 | 02.03 - | M 112.912 Twin Spark | 6 | | PFR5R-11 | 4292 | | LPG 1 | 1496 |
| CLK 270 CDI (209) | 2.7 | 125 | 10.02 - | OM 612.962 | 5 | █ | Y-745U | 6346 | | D-POWER 11 | 6346 |
| CLK 270 CDI (209) | 2.7 | 125 | 10.02 - | OM 612.967 | 5 | █ | Y-745U | 6346 | | D-POWER 11 | 6346 |
| CLK 280 (209) | 3.0 | 170 | 01.05 - | M 272.940 | 6 | | PLKR7A | 4288 | | PLKR7A | 4288 |
| CLK 320 (209) | 3.2 | 160 | 03.03 - | M 112.955 Twin Spark | 6 | | PFR5R-11 | 4292 | | LPG 1 | 1496 |
| CLK 320 CDI (209) | 3.0 | 165 | 01.05 - | OM 642.910 | 6 | █ | Y8002AS | 6287 | | D-POWER 51 | 6287 |
| CLK 320 V6 (208) | 3.2 | 160 | 06.97 - 02 | M 112.940 Twin Spark | 6 | | PFR5R-11 | 4292 | | LPG 1 | 1496 |
| CLK 350 (209) | 3.5 | 200 | 01.05 - | M 272.960 | 6 | | PLKR7A | 4288 | | PLKR7A | 4288 |
| CLK 430 (208) | 4.3 | 205 | 06.98 - 02 | M 113.943 Twin Spark | 8 | | PFR5R-11 | 4292 | | LPG 1 | 1496 |
| CLK 500 (209) | 5.0 | 225 | 06.02 - | M 113.968 Twin Spark | 8 | | PFR5R-11 | 4292 | | LPG 1 | 1496 |
| CLK 500 (209) | 5.5 | 286 | 06 - | M 273.967 | 8 | | PLKR7A | 4288 | | PLKR7A | 4288 |
| CLK 55 (208) | 5.5 | 255 | 08.99 - 03 | M 113.984 Twin Spark | 8 | | PFR5R-11 | 4292 | | LPG 1 | 1496 |
| CLK 55 AMG (209) | 5.4 | 270 | 09.02 - | M 113.987 Twin Spark | 8 | | IFR6D10 | 5344 | | LPG 1 | 1496 |
| CLK 63 AMG (209) | 6.3 | 378 | 06 - | M 156.982 | 8 | | ILZKAR7A10 | 6043 | | ILZKAR7A10 | 6043 |
| CLS 280 (219) | 3.0 | 170 | 07 - | M 272.943 | 6 | | PLKR7A | 4288 | | PLKR7A | 4288 |
| CLS 320 CDI (219) | 3.0 | 165 | 01.05 - | OM 642.920 | 6 | █ | CZ303 | 7865 | | D-POWER 54 | 7865 |
| CLS 350 (219) | 3.5 | 200 | 10.04 - | M 272.964 | 6 | | PLKR7A | 4288 | | PLKR7A | 4288 |
| CLS 350 CGI (219) | 3.5 | 215 | 04.06 - | M 272.985 | 6 | | SILZKR7A-S | 7718 | | SILZKR7A-S | 7718 |
| CLS 500 (219) | 5.0 | 225 | 10.04 - | M 113.967 Twin Spark | 8 | | PFR5R-11 | 4292 | | LPG 1 | 1496 |
| CLS 500 (219) | 5.5 | 286 | 04.06 - | M 273.960 | 8 | | PLKR7A | 4288 | | PLKR7A | 4288 |
| CLS 55 AMG (219) | 5.5 | 350 | 01.05 - | M 113.990 Twin Spark | 8 | | ILFR6A | 3588 | | ILFR6A | 3588 |
| CLS 63 AMG (219) | 6.3 | 378 | 05.06 - | M 156.983 | 8 | | ILZKAR7A10 | 6043 | | ILZKAR7A10 | 6043 |
| E 200 (124) | 2.0 | 100 | 06.93 - 06.97 | M 111.942 | 4 | | BCP6ES | 4930 | 17 | LPG 3 | 1498 |
| E 200 (124) | 2.0 | | 07.93 - 06.95 | M 111.921 | 4 | | BCP6ES | 4930 | 17 | LPG 3 | 1498 |
| E 200 (210) | 2.0 | 100 | 06.95 - 06.97 | M 111.942 | 4 | | BCP5ES | 7496 | 16 | LPG 3 | 1498 |
| E 200 (210) | 2.0 | 100 | 07.97 - 08.00 | M 111.942 | 4 | | BKUR5ET | 2789 | 29 | LPG 1 | 1496 |
| E 200 CDI (210) | 2.2 | 75 | 06.98 - 06.99 | OM 611.961 | 4 | █ | Y-745U | 6346 | | D-POWER 11 | 6346 |
| E 200 CDI (210) | 2.2 | 85 | 07.99 - 03.03 | OM 611.961 | 4 | █ | Y-745U | 6346 | | D-POWER 11 | 6346 |
| E 200 CDI (211) | 2.2 | 90 | 07.02 - | OM 646.951 | 4 | █ | Y-745U | 6346 | | D-POWER 11 | 6346 |
| E 200 CDI (211) | 2.2 | 100 | 04.06 - | OM 646.820 | 4 | █ | CZ106 | 9957 | | D-POWER 53 | 9957 |
| E 200 CDI (211) | 2.2 | 125 | 06 - | OM 646.821 | 4 | █ | CZ106 | 9957 | | D-POWER 53 | 9957 |
| E 200 CDI BlueEfficiency (212) | 2.2 | 100 | 05.09 - | OM 651.925 | 4 | █ | CZ303 | 7865 | | D-POWER 54 | 7865 |
| E 200 D (124) | 2.0 | 53 | 07.93 - 05.95 | OM 601.912 | 4 | █ | Y-916J | 5906 | | D-POWER 6 | 5906 |
| E 200 D (210) | 2.0 | 65 | 01.96 - 03.02 | OM 604.917 | 4 | █ | Y-925J | 6848 | | D-POWER 16 | 6848 |
| E 200 Kompressor (210) | 2.0 | 120 | 06.00 - 03.03 | M 111.957 | 4 | | IFR6D10 | 5344 | | LPG 1 | 1496 |
| E 200 Kompressor (210) | 2.0 | 137 | 09.96 - 03.03 | M 111.947 | 4 | | BKUR6ET-10 | 2397 | 24 | LPG 1 | 1496 |
| E 200 Kompressor (211) | 1.8 | 120 | 11.02 - 11.06 | M 271.941 -> 30853899 | 4 | | ILFR6A | 3588 | | ILFR6A | 3588 |
| E 200 Kompressor (211) | 1.8 | 135 | 04.06 - 11.06 | M 271.956 -> 30853899 | 4 | | ILFR6A | 3588 | | ILFR6A | 3588 |
| E 220 (124) | 2.2 | 110 | 06.93 - 06.95 | M 111.960 | 4 | | BCP6ES | 4930 | 17 | LPG 3 | 1498 |
| E 220 CDI (210) | 2.2 | 92 | 06.98 - 06.99 | OM 611.961 | 4 | █ | Y-745U | 6346 | | D-POWER 11 | 6346 |
| E 220 CDI (210) | 2.2 | 105 | 07.99 - 03.03 | OM 611.961 | 4 | █ | Y-745U | 6346 | | D-POWER 11 | 6346 |
| E 220 CDI (211) | 2.2 | 110 | 03.03 - | OM 646.961 | 4 | █ | Y-745U | 6346 | | D-POWER 11 | 6346 |
| E 220 CDI (211) | 2.2 | 125 | 04.06 - | OM 646.821 | 4 | █ | CZ106 | 9957 | | D-POWER 53 | 9957 |
| E 220 CDI BlueEfficiency (212) | 2.2 | 125 | 03.09 - | OM 651.924 | 4 | █ | CZ303 | 7865 | | D-POWER 54 | 7865 |
| E 220 D (210) | 2.2 | 55 | 05.96 - 03.02 | OM 611.913 | 4 | █ | Y-925J | 6848 | | D-POWER 16 | 6848 |
| E 220 D (210) | 2.2 | 70 | 03.95 - 03.02 | OM 604.912 | 4 | █ | Y-925J | 6848 | | D-POWER 16 | 6848 |



ℓ kW

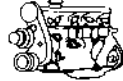

Cyl.

Order-
No.VLINE
No.LPG/CNG
D-PowerOrder-
No.**MERCEDES**

| | | | | | | | | | | | |
|--------------------------------|-----|-----|-------------|----------------------|---|---|------------|------|----|------------|------|
| E 220 D (210) | 2.2 | 105 | 07.99-03.02 | OM 611.962 | 4 | █ | Y-745U | 6346 | | D-POWER 11 | 6346 |
| E 230 (210) | 2.3 | 110 | 06.95-06.97 | M 111.970 | 4 | | BCP5ES | 7496 | 16 | LPG 3 | 1498 |
| E 230 (211) | 2.5 | 150 | 09.07- | M 272.922 | 6 | | PLKR7A | 4288 | | PLKR7A | 4288 |
| E 240 (210) | 2.6 | 125 | 06.00-03.03 | M 112.914 Twin Spark | 6 | | PFR5R-11 | 4292 | | LPG 1 | 1496 |
| E 240 (211) | 2.6 | 130 | 03.02- | M 112.913 Twin Spark | 6 | | PFR5R-11 | 4292 | | LPG 1 | 1496 |
| E 240 V6 (210) | 2.4 | 125 | 04.97-06.99 | M 112.911 Twin Spark | 6 | | PFR5R-11 | 4292 | | LPG 1 | 1496 |
| E 240 4-matic (211) | 2.6 | 130 | 03.03- | M 112.917 Twin Spark | 6 | | PFR5R-11 | 4292 | | LPG 1 | 1496 |
| E 250 CDI BlueEfficiency (212) | 2.2 | 150 | 03.09- | OM 651.924 | 4 | █ | CZ303 | 7865 | | D-POWER 54 | 7865 |
| E 250 D (124) | 2.5 | 66 | 07.93- | OM 602.912/962 | 5 | █ | Y-916J | 5906 | | D-POWER 6 | 5906 |
| E 250 D (124) | 2.5 | 83 | 07.93-05.95 | OM 605.911 | 5 | █ | ◆ Y-930U § | 4275 | | D-POWER 30 | 4275 |
| E 250 D (124) | 2.5 | 83 | 07.93-04.96 | OM 605.911/912 | 5 | █ | Y-925J | 6848 | | D-POWER 16 | 6848 |
| E 250 D (210) | 2.5 | 83 | 03.95-07.99 | OM 605.912 | 5 | █ | Y-925J | 6848 | | D-POWER 16 | 6848 |
| E 250 T,TD (124) | 2.5 | 66 | 07.93- | OM 602.962 | 5 | █ | Y-916J | 5906 | | D-POWER 6 | 5906 |
| E 250 TD (124) | 2.5 | 93 | 07.93-05.95 | OM 602.962 | 5 | █ | Y-916J | 5906 | | D-POWER 6 | 5906 |
| E 250 TD (210) | 2.5 | 110 | 06.97-07.99 | OM 605.962 | 5 | █ | Y-925J | 6848 | | D-POWER 16 | 6848 |
| E 270 CDI (210) | 2.7 | 105 | 07.99-03.03 | OM 612.961 | 5 | █ | Y-745U | 6346 | | D-POWER 11 | 6346 |
| E 270 CDI (211) | 2.7 | 130 | 03.03- | OM 647.961 | 5 | █ | Y-745U | 6346 | | D-POWER 11 | 6346 |
| E 280 (124) | 2.8 | 142 | 07.93-02.97 | M 104.942 | 6 | | BCP6ES | 4930 | 17 | LPG 3 | 1498 |
| E 280 (124) | 2.8 | 142 | 06.93-06.95 | M 104.945 | 6 | | BCP6ES | 4930 | 17 | LPG 3 | 1498 |
| E 280 (210) | 2.8 | 142 | 01.96-06.99 | M 104.945 | 6 | | BCP5ES | 7496 | 16 | LPG 3 | 1498 |
| E 280 (211) | 3.0 | 170 | 01.06- | M 272.943 | 6 | | PLKR7A | 4288 | | PLKR7A | 4288 |
| E 280 V6 (210) | 2.8 | 150 | 03.97-03.03 | M 112.921 Twin Spark | 6 | | PFR5R-11 | 4292 | | LPG 1 | 1496 |
| E 280 4-matic (211) | 3.0 | 140 | 03.05- | OM 642.921 | 6 | █ | CZ303 | 7865 | | D-POWER 54 | 7865 |
| E 280 4-Matic (211) | 3.0 | 170 | 01.06- | M 272.944 | 6 | | PLKR7A | 4288 | | PLKR7A | 4288 |
| E 280 CDI (211) | 3.0 | 140 | 03.05- | OM 642.920 | 6 | █ | CZ303 | 7865 | | D-POWER 54 | 7865 |
| E 280 CDI (211) | 3.2 | 130 | 05.04- | OM 648.961 | 6 | █ | Y-745U | 6346 | | D-POWER 11 | 6346 |
| E 290 TD (210) | 2.9 | 95 | 06.95-07.99 | OM 602.982 | 5 | █ | Y-929U | 1749 | | D-POWER 41 | 1749 |
| E 300 24V (124) | 3.0 | 162 | 06.93-06.97 | M 104.980 | 6 | | BCP6ES | 4930 | 17 | LPG 3 | 1498 |
| E 300 4 MATIC (124) | 3.0 | 132 | 09.86-06.93 | M 103.985 | 6 | | BP6EFS | 3812 | 5 | LPG 5 | 1516 |
| E 300 CDI Bluetec (211) | 3.0 | 165 | 08- | OM 642.920 | 6 | █ | CZ303 | 7865 | | D-POWER 54 | 7865 |
| E 300 D (124) | 3.0 | 100 | 07.93-05.95 | OM 606.910 | 6 | █ | ◆ Y-930U | 4275 | | D-POWER 30 | 4275 |
| E 300 D (210) | 3.0 | 100 | 03.95-06.97 | OM 606.912 | 6 | █ | Y-925J | 6848 | | D-POWER 16 | 6848 |
| E 300 TD (124) | 3.0 | 100 | 06.95-06.96 | OM 606.910 | 6 | █ | Y-925J | 6848 | | D-POWER 16 | 6848 |
| E 300 TD (124) | 3.0 | 100 | 07.93-05.95 | OM 606.910 | 6 | █ | ◆ Y-930U § | 4275 | | D-POWER 30 | 4275 |
| E 300 TD (124) | 3.0 | 108 | 07.93- | OM 603.960 | 6 | █ | Y-916J | 5906 | | D-POWER 6 | 5906 |
| E 300 Td T (210) | 3.0 | 130 | 03.97-07.99 | OM 606.962 | 6 | █ | ◆ Y-930U § | 4275 | | D-POWER 30 | 4275 |
| E 300 Td T (210) | 3.0 | 130 | 03.97-07.99 | OM 606.962 | 6 | █ | Y-925J | 6848 | | D-POWER 16 | 6848 |
| E 320 (211) | 3.2 | 165 | 03.02- | M 112.949 Twin Spark | 6 | | PFR5R-11 | 4292 | | LPG 1 | 1496 |
| E 320 (124) | 3.2 | 162 | 06.93-06.95 | M 104.992 | 6 | | BCP6ES | 4930 | 17 | LPG 3 | 1498 |
| E 320 (210) | 3.2 | 170 | 06.95-05.99 | M 104.995 | 6 | | BCP5ES | 7496 | 16 | LPG 3 | 1498 |
| E 320 4-matic (211) | 3.2 | 165 | 03.03- | M 112.954 Twin Spark | 6 | | PFR5R-11 | 4292 | | LPG 1 | 1496 |
| E 320 V6 (210) | 3.2 | 165 | 06.99-03.03 | M 112.941 Twin Spark | 6 | | PFR5R-11 | 4292 | | LPG 1 | 1496 |
| E 320 CDI (211) | 3.2 | 150 | 03.03- | OM 648.961 | 6 | █ | Y-745U | 6346 | | D-POWER 11 | 6346 |
| E 320 CDI (210) | 3.2 | 145 | 07.99-03.03 | OM 613.961 | 6 | █ | Y-745U | 6346 | | D-POWER 11 | 6346 |
| E 320 CDI (211) | 3.0 | 165 | 03.05- | OM 642.920 | 6 | █ | CZ303 | 7865 | | D-POWER 54 | 7865 |
| E 320 CDI 4-matic (211) | 3.0 | 165 | 03.05- | OM 642.921 | 6 | █ | CZ303 | 7865 | | D-POWER 54 | 7865 |
| E 350 (211) | 3.5 | 200 | 10.04- | M 272.964 | 6 | | PLKR7A | 4288 | | PLKR7A | 4288 |
| E 350 4-matic (211) | 3.5 | 200 | 11.04- | M 272.972 | 6 | | PLKR7A | 4288 | | PLKR7A | 4288 |
| E 350 CDI BlueEfficiency (212) | 3.0 | 171 | 03.09- | OM 642.850 | 6 | █ | CZ303 | 7865 | | D-POWER 54 | 7865 |
| E 350 CDI BlueTec (212) | 3.0 | 155 | 03.09- | OM 642.850 | 6 | █ | CZ303 | 7865 | | D-POWER 54 | 7865 |
| E 350 CGI (211) | 3.5 | 215 | 08- | M 272.985 | 6 | | SILZKR7A-S | 7718 | | SILZKR7A-S | 7718 |
| E 350 CGI BlueEfficiency (212) | 3.5 | 215 | 03.09- | M 272.983 | 6 | | SILZKR7A-S | 7718 | | SILZKR7A-S | 7718 |





ℓ kW



Cyl.

Order-
No. No.

VALVE

LPG/CNG
D-PowerOrder-
No.**MERCEDES**

| | | | | | | | | | | |
|---------------------------|-----|-----|---------------|----------------------|---|------------|------|----|------------|------|
| E 400 CDI (211) | 4.0 | 191 | 02.03 - | OM 628.961 | 8 | Y-745U | 6346 | | D-POWER 11 | 6346 |
| E 420 (124) | 4.2 | 205 | 06.93 - 06.95 | M 119.975 | 8 | BCP6ES | 4930 | 17 | LPG 3 | 1498 |
| E 420 CDI (211) | 4.0 | 231 | 09.05 - | OM 629.910 | 8 | Y8002AS | 6287 | | D-POWER 51 | 6287 |
| E 420 V8 (210) | 4.2 | 205 | 01.96 - 06.97 | M 119.985 | 8 | BCP6ES | 4930 | 17 | LPG 3 | 1498 |
| E 420 V8 (210) | 4.2 | 205 | 07.97 - 05.98 | M 119.985 | 8 | BKUR5ET | 2789 | 29 | LPG 1 | 1496 |
| E 430 V8 (210) | 4.3 | 205 | 04.97 - 03.03 | M 113.940 Twin Spark | 8 | PFR5R-11 | 4292 | | LPG 1 | 1496 |
| E 50 (210) | 5.0 | 255 | 02.96 - 08.97 | M 119.985 | 8 | BKR5EKU | 3964 | | | |
| E 50 AMG (USA) (210) | 5.0 | 235 | 02.96 - 05.99 | M 119.980 | 8 | BCP6ES | 4930 | 17 | LPG 3 | 1498 |
| E 500 (124) | 5.0 | 235 | 06.93 - 06.95 | M 119.974 | 8 | BCP6ES | 4930 | 17 | LPG 3 | 1498 |
| E 500 (211) | 5.0 | 225 | 03.02 - | M 113.967 Twin Spark | 8 | PFR5R-11 | 4292 | | LPG 1 | 1496 |
| E 500 (211) | 5.5 | 285 | 04.06 - | M 273.960 | 8 | PLKR7A | 4288 | | PLKR7A | 4288 |
| E 500 (211) | 5.5 | 300 | 04.06 - | M 273.962 | 8 | PLKR7A | 4288 | | PLKR7A | 4288 |
| E 500 (212) | 5.0 | 286 | 03.09 - | M 273.971 | 8 | PLKR7A | 4288 | | PLKR7A | 4288 |
| E 500 4-matic (211) | 5.0 | 225 | 03.03 - | M 113.969 Twin Spark | 8 | PFR5R-11 | 4292 | | LPG 1 | 1496 |
| E 55 AMG (210) | 5.5 | 260 | 09.97 - 03.03 | M 113.980 Twin Spark | 8 | PFR5R-11 | 4292 | | LPG 1 | 1496 |
| E 55 AMG (211) | 5.5 | 350 | 10.02 - | M 113.990 Twin Spark | 8 | ILFR6A | 3588 | | ILFR6A | 3588 |
| E 63 AMG (211) | 6.3 | 378 | 05.06 - | M 156.983 | 8 | ILZKAR7A10 | 6043 | | ILZKAR7A10 | 6043 |
| E 63 AMG (212) | 6.3 | | 09 - | M 156.985 | 8 | ILZKAR7A10 | 6043 | | ILZKAR7A10 | 6043 |
| E-Coupe 220 CDI (207) | 2.2 | | 09 - | OM 651.911 | 4 | CZ303 | 7865 | | D-POWER 54 | 7865 |
| E-Coupe 250 CDI (207) | 2.2 | 150 | 09 - | OM 651.911 | 4 | CZ303 | 7865 | | D-POWER 54 | 7865 |
| E-Coupe 350 CDI (207) | 3.0 | 170 | 09 - | OM 642.836 | 6 | CZ303 | 7865 | | D-POWER 54 | 7865 |
| E-Coupe 350 CGI (207) | 3.5 | 215 | 09 - | M 272.982 | 6 | SILZKR7A-S | 7718 | | SILZKR7A-S | 7718 |
| E-Coupe 500 (207) | 5.5 | 286 | 09 - | M 273.966 | 8 | PLKR7A | 4288 | | PLKR7A | 4288 |
| G 200 (463) | 2.0 | 80 | 09.93 - | M 102.965 | 4 | BP6EFS | 3812 | 5 | LPG 5 | 1516 |
| G 230 (463) | 2.3 | 93 | 08.93 - 10.94 | M 102.989 | 4 | BP6EFS | 3812 | 5 | LPG 5 | 1516 |
| G 270 CDI (461) | 2.7 | 115 | | OM 612.965 | 5 | Y-745U | 6346 | | D-POWER 11 | 6346 |
| G 270 CDI (461) | 2.7 | | | OM 612.963 | 5 | Y-745U | 6346 | | D-POWER 11 | 6346 |
| G 270 CDI (461) | 2.7 | | | OM 612.966 | 5 | Y-745U | 6346 | | D-POWER 11 | 6346 |
| G 270 CDI (463) | 2.7 | 115 | 10.01 - | OM 612.965 | 5 | Y-745U | 6346 | | D-POWER 11 | 6346 |
| G 300 (463) | 3.0 | 126 | 08.93 - 10.94 | M 103.987 | 6 | BP6EFS | 3812 | 5 | LPG 5 | 1516 |
| G 300 D (463) | 3.0 | 83 | 08.93 - | OM 603.931 | 6 | Y-916J | 5906 | | D-POWER 6 | 5906 |
| G 300 TD (463) | 3.0 | 130 | 08.96 - | OM 606.964 | 6 | Y-925J | 6848 | | D-POWER 16 | 6848 |
| G 320 (463) | 3.2 | 155 | 09.93 - 12.97 | M 104.996 | 6 | BCP5ES | 7496 | 16 | LPG 3 | 1498 |
| G 320 (463) | 3.2 | 158 | 07.97 - | M 112.945 Twin Spark | 6 | PFR5R-11 | 4292 | | LPG 1 | 1496 |
| G 320 CDI (463) | 3.0 | 165 | 09.06 - | OM 642.970 | 6 | CZ303 | 7865 | | D-POWER 54 | 7865 |
| G 36 AMG (463) | 3.2 | 155 | 01.95 - | M 104.996 | 6 | BCP5ES | 7496 | 16 | LPG 3 | 1498 |
| G 400 CDI (463) | 4.0 | 184 | 12.00 - | OM 628.962 | 8 | Y-745U | 6346 | | D-POWER 11 | 6346 |
| G 500 (463) | 5.0 | 195 | 08.93 - 10.94 | M 117.965 | 8 | BP6ES | 7811 | 4 | LPG 2 | 1497 |
| G 500 (463) | 5.0 | 218 | 00 - | M 113.962 Twin Spark | 8 | PFR5R-11 | 4292 | | LPG 1 | 1496 |
| G 55 AMG (463) | 5.0 | 218 | 04.99 - | M 113.962 Twin Spark | 8 | PFR5R-11 | 4292 | | LPG 1 | 1496 |
| G 55 AMG (463) | 5.5 | 260 | 04.99 - | M 113.982 Twin Spark | 8 | PFR5R-11 | 4292 | | LPG 1 | 1496 |
| G 55 AMG (463) | 5.5 | 350 | 06.04 - | M 113.993 Twin Spark | 8 | ILFR6A | 3588 | | ILFR6A | 3588 |
| GL 320 CDI (X164) | 3.0 | 165 | 01.06 - | OM 642.940 | 6 | Y8002AS | 6287 | | D-POWER 51 | 6287 |
| GL 320 CDI (X164) USA | 3.0 | 165 | 01.06 - | OM 642.940 | 6 | CZ303 | 7865 | | D-POWER 54 | 7865 |
| GL 420 CDI (X164) | 4.0 | 225 | 01.06 - | OM 629.912 | 8 | Y8002AS | 6287 | | D-POWER 51 | 6287 |
| GL 450 (X164) | 4.6 | 250 | 01.06 - | M 273.923 | 8 | PLKR7A | 4288 | | PLKR7A | 4288 |
| GL 500 (X164) | 5.5 | 286 | 01.06 - | M 273.963 | 8 | PLKR7A | 4288 | | PLKR7A | 4288 |
| GLK 220 CDI (204) | 2.2 | 125 | 08.08 - | OM 651.916 | 4 | CZ303 | 7865 | | D-POWER 54 | 7865 |
| GLK 220 CDI 4-matic (204) | 2.2 | 125 | 10.08 - | OM 651.912 | 4 | CZ303 | 7865 | | D-POWER 54 | 7865 |
| GLK 280 4-matic (204) | 3.0 | 170 | 08.08 - | M 272.948 | 6 | PLKR7A | 4288 | | PLKR7A | 4288 |
| GLK 320 CDI (204) | 3.0 | 165 | 08.08 - | OM 642.961 | 6 | Y8002AS | 6287 | | D-POWER 51 | 6287 |
| GLK 350 (204) | 3.5 | 200 | 08.08 - | M 272.961 | 6 | PLKR7A | 4288 | | PLKR7A | 4288 |



ℓ kW

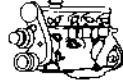

Cyl.

Order-
No. No.

VLINE

LPG/CNG
D-PowerOrder-
No.**MERCEDES**

| | | | | | | | | | | | |
|-------------------------|-----|-----|--------------|----------------------|---|-----|------------|------|----|------------|------|
| GLK 350 4-Matic (204) | 3.5 | 200 | 08 - | M 272.971 | 6 | | PLKR7A | 4288 | | PLKR7A | 4288 |
| L 410 | 2.3 | 70 | 08.82 - | M 102.943 | 4 | 0,8 | BP6EFS | 3812 | 5 | LPG 5 | 1516 |
| MB 100 | 2.4 | 43 | 02.89 - | OM 615.970 | 4 | | Y-924J | 7906 | | D-POWER 1 | 7906 |
| MB 100 D | 2.4 | 56 | 02.89 - | OM 616.963 | 4 | | Y-916J | 5906 | | D-POWER 6 | 5906 |
| MB 100 D | 2.4 | 56 | 09.87 -01.89 | OM 616.963 | 4 | | Y-924J | 7906 | | D-POWER 1 | 7906 |
| ML 230 (163) | 2.3 | 110 | 02.98 -06.05 | M 111.977 | 4 | | BKUR5ET | 2789 | 29 | LPG 1 | 1496 |
| ML 270 CDI (163) | 2.7 | 120 | 12.99 -06.05 | OM 612.963 | 5 | | Y-745U | 6346 | | D-POWER 11 | 6346 |
| ML 280 CDI (164) | 3.0 | 140 | 10.05 - | OM 642.940 | 6 | | Y8002AS | 6287 | | D-POWER 51 | 6287 |
| ML 280 CDI (164) USA | 3.0 | 140 | 10.05 - | OM 642.940 | 6 | | CZ303 | 7865 | | D-POWER 54 | 7865 |
| ML 320 (163) | 3.2 | 160 | 02.98 -08.02 | M 112.942 Twin Spark | 6 | | PFR5R-11 | 4292 | | LPG 1 | 1496 |
| ML 320 CDI (164) | 3.0 | 165 | 07.05 - | OM 642.940 | 6 | | Y8002AS | 6287 | | D-POWER 51 | 6287 |
| ML 320 CDI (164) USA | 3.0 | 165 | 07.05 - | OM 642.940 | 6 | | CZ303 | 7865 | | D-POWER 54 | 7865 |
| ML 350 (163) | 3.7 | 173 | 08.00 -06.05 | M 112.970 Twin Spark | 6 | | PFR5R-11 | 4292 | | LPG 1 | 1496 |
| ML 350 (164) | 3.5 | 200 | 12.04 - | M 272.967 | 6 | | PLKR7A | 4288 | | PLKR7A | 4288 |
| ML 400 CDI (163) | 4.0 | 184 | 09.00 -06.05 | OM 628.963 | 8 | | Y-745U | 6346 | | D-POWER 11 | 6346 |
| ML 420 CDI (164) | 4.0 | 225 | 02.06 - | OM 629.912 | 8 | | Y8002AS | 6287 | | D-POWER 51 | 6287 |
| ML 430 (163) | 4.3 | 200 | 11.98 -06.05 | M 113.942 Twin Spark | 8 | | PFR5R-11 | 4292 | | LPG 1 | 1496 |
| ML 500 (163) | 5.0 | 215 | 09.00 -06.04 | M 113.965 Twin Spark | 8 | | PFR5R-11 | 4292 | | LPG 1 | 1496 |
| ML 500 (164) | 5.0 | 225 | 12.04 - | M 113.964 Twin Spark | 8 | | PFR5R-11 | 4292 | | LPG 1 | 1496 |
| ML 500 (164) | 5.5 | 286 | 12.07 - | M 273.963 | 8 | | PLKR7A | 4288 | | PLKR7A | 4288 |
| ML 55 AMG (163) | 5.5 | 255 | 11.99 -06.05 | M 113.981 Twin Spark | 8 | | PFR5R-11 | 4292 | | LPG 1 | 1496 |
| ML 63 AMG (164) | 6.3 | 375 | 01.06 - | M 156.980 | 8 | | ILZKAR7A10 | 6043 | | ILZKAR7A10 | 6043 |
| O 309 B | 2.3 | 70 | 08.82 - | M 102.943 | 4 | 0,8 | BP6EFS | 3812 | 5 | LPG 5 | 1516 |
| R 280 (251) | 3.0 | 170 | 02.06 - | M 272.945 | 6 | | PLKR7A | 4288 | | PLKR7A | 4288 |
| R 280 CDI (251) | 3.0 | | 07 - | OM 642.870 | 6 | | CZ303 | 7865 | | D-POWER 54 | 7865 |
| R 280 CDI (251) USA | 3.0 | 140 | 02.06 - | OM 642.950 | 6 | | CZ303 | 7865 | | D-POWER 54 | 7865 |
| R 320 CDI (251) USA | 3.0 | 165 | 02.06 - | OM 642.950 | 6 | | CZ303 | 7865 | | D-POWER 54 | 7865 |
| R 350 (251) | 3.5 | 200 | 02.06 - | M 272.967 | 6 | | PLKR7A | 4288 | | PLKR7A | 4288 |
| R 500 (251) | 5.0 | 225 | 02.06 - | M 113.971 Twin Spark | 8 | | PFR5R-11 | 4292 | | LPG 1 | 1496 |
| R 500 (251) | 5.5 | 286 | 07 - | M 273.963 | 8 | | PLKR7A | 4288 | | PLKR7A | 4288 |
| R 63 AMG (251) | 6.3 | 375 | 11.05 - | M 156.980 | 8 | | ILZKAR7A10 | 6043 | | ILZKAR7A10 | 6043 |
| S 280 (140) | 2.8 | 142 | 07.93 -06.97 | M 104.944 | 6 | | BCP6ES | 4930 | 17 | LPG 3 | 1498 |
| S 280 (220) | 2.8 | 142 | 10.99 -08.05 | M 112.922 Twin Spark | 6 | | PFR5R-11 | 4292 | | LPG 1 | 1496 |
| S 280 (221) | 3.0 | 170 | 05 - | M 272.946 | 6 | | PLKR7A | 4288 | | PLKR7A | 4288 |
| S 300 (140) | 3.0 | 130 | 05.96 -10.98 | OM 606.961 | 6 | | Y-930U § | 4275 | | D-POWER 30 | 4275 |
| S 300 (140) | 3.0 | 130 | 05.96 -10.98 | OM 606.961 | 6 | | Y-925J | 6848 | | D-POWER 16 | 6848 |
| S 320 (140) | 3.2 | 170 | 07.93 -06.97 | M 104.994 | 6 | | BCP6ES | 4930 | 17 | LPG 3 | 1498 |
| S 320 (220) | 3.2 | 165 | 10.98 -08.05 | M 112.944 Twin Spark | 6 | | PFR5R-11 | 4292 | | LPG 1 | 1496 |
| S 320 CDI (220) | 3.2 | 145 | 08.99 -09.02 | OM 613.960 | 6 | | Y-745U | 6346 | | D-POWER 11 | 6346 |
| S 320 CDI (220) | 3.2 | 150 | 09.02 -08.05 | OM 648.960 | 6 | | Y-745U | 6346 | | D-POWER 11 | 6346 |
| S 320 CDI (221) | 3.0 | 173 | 03.06 - | OM 642.930 | 6 | | Y8002AS | 6287 | | D-POWER 51 | 6287 |
| S 320 CDI 4-Matic (221) | 3.0 | 173 | 10.06 - | OM 642.932 | 6 | | Y8002AS | 6287 | | D-POWER 51 | 6287 |
| S 350 (220) | 3.7 | 180 | 09.02 -08.05 | M 112.972 Twin Spark | 6 | | PFR5R-11 | 4292 | | LPG 1 | 1496 |
| S 350 (221) | 3.5 | 200 | 10.05 - | M 272.965 | 6 | | PLKR7A | 4288 | | PLKR7A | 4288 |
| S 350 4Matic (221) | 3.5 | 200 | 06.07 - | M 272.975 | 6 | | PLKR7A | 4288 | | PLKR7A | 4288 |
| S 350 4-matic (220) | 3.7 | 180 | 06.03 -08.05 | M 112.975 Twin Spark | 6 | | PFR5R-11 | 4292 | | LPG 1 | 1496 |
| S 350 TD (140) | 3.5 | 110 | 93 - | | 6 | | Y-916J | 5906 | | D-POWER 6 | 5906 |
| S 400 BlueHybrid (221) | 3.5 | 230 | 09 - | M 272.974 | 6 | | PLKR7A | 4288 | | PLKR7A | 4288 |
| S 400 CDI (220) | 4.0 | 184 | 00 -08.05 | OM 628.960 | 8 | | Y-745U | 6346 | | D-POWER 11 | 6346 |
| S 420 (140) | 4.2 | 205 | 07.93 -06.97 | M 119.971 | 8 | | BCP6ES | 4930 | 17 | LPG 3 | 1498 |
| S 420 (140) | 4.2 | 205 | 06.93 -06.97 | M 119.981 | 8 | | BCP6ES | 4930 | 17 | LPG 3 | 1498 |
| S 420 CDI (221) | 4.0 | 235 | 10.06 - | OM 629.911 | 8 | | Y8002AS | 6287 | | D-POWER 51 | 6287 |





ℓ kW



Cyl.

Order-
No.VALVE
No.LPG/CNG
D-PowerOrder-
No.**MERCEDES**

| | | | | | | | | | | | |
|---------------------------|-----|-----|---------------|-----------|------------|----|------------|------|----|------------|------|
| S 430 (220) | 4.3 | 205 | 10.98 - 08.05 | M 113.941 | Twin Spark | 8 | PFR5R-11 | 4292 | 17 | LPG 1 | 1496 |
| S 430 4-matic (220) | 4.3 | 205 | 09.02 - 08.05 | M 113.948 | Twin Spark | 8 | PFR5R-11 | 4292 | | LPG 1 | 1496 |
| S 450 (221) | 4.6 | 250 | 07.05 - | M 273.922 | | 8 | PLKR7A | 4288 | | PLKR7A | 4288 |
| S 450 4-Matic (221) | 4.6 | 250 | 12.05 - | M 273.924 | | 8 | PLKR7A | 4288 | | PLKR7A | 4288 |
| S 500 (140) | 5.0 | 235 | 07.93 - 06.97 | M 119.970 | | 8 | BCP6ES | 4930 | 17 | LPG 3 | 1498 |
| S 500 (220) | 5.0 | 225 | 10.98 - 08.05 | M 113.960 | Twin Spark | 8 | PFR5R-11 | 4292 | | LPG 1 | 1496 |
| S 500 (221) | 5.5 | 285 | 07.05 - | M 273.961 | | 8 | PLKR7A | 4288 | | PLKR7A | 4288 |
| S 500 4-matic (220) | 5.0 | 225 | 09.02 - 08.05 | M 113.966 | Twin Spark | 8 | PFR5R-11 | 4292 | | LPG 1 | 1496 |
| S 500 4-Matic (221) | 5.5 | 285 | 10.05 - | M 273.968 | | 8 | PLKR7A | 4288 | | PLKR7A | 4288 |
| S 55 (220) | 5.5 | 265 | 99 - 08.05 | M 113.980 | Twin Spark | 8 | PFR5R-11 | 4292 | | LPG 1 | 1496 |
| S 55 AMG (220) | 5.5 | 265 | 04.99 - 08.05 | M 113.986 | Twin Spark | 8 | PFR5R-11 | 4292 | | LPG 1 | 1496 |
| S 55 AMG Kompressor (220) | 5.5 | 368 | 02 - 08.05 | M 113.991 | Twin Spark | 8 | ILFR6A | 3588 | | ILFR6A | 3588 |
| S 600 (140) | 6.0 | 290 | 07.93 - 06.97 | M 120.980 | | 12 | BCP6ES | 4930 | 17 | LPG 3 | 1498 |
| S 600 (140) | 6.0 | 290 | 06.93 - 06.97 | M 120.982 | | 12 | BCP6ES | 4930 | 17 | LPG 3 | 1498 |
| S 600 (220) | 6.0 | 270 | 01.00 - 08.05 | M 137.970 | Twin Spark | 12 | IFR6Q-G | 5648 | | IFR6Q-G | 5648 |
| S 600 (220) | 6.0 | 368 | 01 - 08.05 | M 275.950 | Twin Spark | 12 | IFR6Q-G | 5648 | | IFR6Q-G | 5648 |
| S 600 (221) | 6.0 | 380 | 03.06 - | M 275.953 | Twin Spark | 12 | IFR6Q-G | 5648 | | IFR6Q-G | 5648 |
| S 63 AMG (221) | 6.3 | 386 | 10.06 - | M 156.984 | | 8 | ILZKAR7A10 | 6043 | | ILZKAR7A10 | 6043 |
| S 65 AMG (220) | 6.0 | 450 | 03 - 08.05 | M 275.980 | Twin Spark | 12 | IFR6Q-G | 5648 | | IFR6Q-G | 5648 |
| S 65 AMG (221) | 6.0 | 450 | 12.05 - | M 275.982 | Twin Spark | 12 | IFR6Q-G | 5648 | | IFR6Q-G | 5648 |
| SL 280 (129) | 2.8 | 141 | 07.93 - 06.97 | M 104.943 | | 6 | BCP6ES | 4930 | 17 | LPG 3 | 1498 |
| SL 280 (129) | 2.8 | 142 | 07.97 - 05.98 | M 104.943 | | 6 | BKUR5ET | 2789 | 29 | LPG 1 | 1496 |
| SL 280 (129) | 2.8 | 150 | 06.98 - | M 112.923 | Twin Spark | 6 | PFR5R-11 | 4292 | | LPG 1 | 1496 |
| SL 280 (230) | 3.0 | | | M 272.949 | | 6 | PLKR7A | 4288 | | PLKR7A | 4288 |
| SL 320 (129) | 3.2 | 165 | 06.98 - | M 112.943 | Twin Spark | 6 | PFR5R-11 | 4292 | | LPG 1 | 1496 |
| SL 320 (129) | 3.2 | 170 | 07.93 - 06.97 | M 104.991 | | 6 | BCP6ES | 4930 | 17 | LPG 3 | 1498 |
| SL 320 (129) | 3.2 | 170 | 07.97 - 05.98 | M 104.991 | | 6 | BKUR5ET | 2789 | 29 | LPG 1 | 1496 |
| SL 350 (230) | 3.5 | 200 | 05.05 - | M 272.966 | | 6 | PLKR7A | 4288 | | PLKR7A | 4288 |
| SL 350 (230) | 3.5 | 233 | 04.08 - | M 272.968 | | 6 | PLKR7A | 4288 | | PLKR7A | 4288 |
| SL 350 (230) | 3.7 | 180 | 03.03 - | M 112.973 | Twin Spark | 6 | PFR5R-11 | 4292 | | LPG 1 | 1496 |
| SL 500 (129) | 5.0 | 225 | 98 - | M 113.961 | Twin Spark | 8 | PFR5R-11 | 4292 | | LPG 1 | 1496 |
| SL 500 (129) | 5.0 | 235 | 07.93 - 06.97 | M 119.972 | | 8 | BCP6ES | 4930 | 17 | LPG 3 | 1498 |
| SL 500 (129) | 5.0 | 235 | 07.93 - 06.97 | M 119.982 | | 8 | BCP6ES | 4930 | 17 | LPG 3 | 1498 |
| SL 500 (230) | 5.0 | 225 | 10.01 - | M 113.963 | Twin Spark | 8 | PFR5R-11 | 4292 | | LPG 1 | 1496 |
| SL 500 (230) | 5.5 | 286 | 03.06 - | M 273.965 | | 8 | PLKR7A | 4288 | | PLKR7A | 4288 |
| SL 500K (230) | 5.0 | 225 | 10.01 - | M 113.963 | Twin Spark | 8 | PFR5R-11 | 4292 | | LPG 1 | 1496 |
| SL 55 AMG (230) | 5.5 | 350 | 10.01 - 06.02 | M 113.992 | Twin Spark | 8 | ILFR6A | 3588 | | ILFR6A | 3588 |
| SL 55 AMG (230) | 5.5 | 368 | 06.02 - | M 113.992 | Twin Spark | 8 | ILFR6A | 3588 | | ILFR6A | 3588 |
| SL 55 AMG (230) | 5.5 | 380 | 03.06 - | M 113.995 | Twin Spark | 8 | ILFR6A | 3588 | | ILFR6A | 3588 |
| SL 60 (129) | 6.0 | 280 | 95 - | M 119.E60 | | 12 | BKR5EKU | 3964 | | | |
| SL 60 AMG (129) | 6.0 | 280 | 95 - | M 119.E60 | | 12 | BKR5EKU | 3964 | | | |
| SL 600 (129) | 6.0 | 290 | 07.93 - 06.97 | M 120.981 | | 12 | BCP6ES | 4930 | 17 | LPG 3 | 1498 |
| SL 600 (129) | 6.0 | 290 | 98 - | M 120.983 | | 12 | PFR5R-11 | 4292 | | LPG 1 | 1496 |
| SL 600 (129) | 6.0 | 290 | 07.93 - 06.97 | M 120.983 | | 12 | BCP5ES | 7496 | 16 | LPG 3 | 1498 |
| SL 600 (230) | 5.5 | 368 | 04.03 - | M 275.951 | Twin Spark | 12 | IFR6Q-G | 5648 | | IFR6Q-G | 5648 |
| SL 600 (230) | 5.5 | 381 | 03.06 - | M 275.954 | Twin Spark | 12 | IFR6Q-G | 5648 | | IFR6Q-G | 5648 |
| SL 63 AMG (230) | 6.3 | 386 | 03.08 - | M 156.981 | | 8 | ILZKAR7A10 | 6043 | | ILZKAR7A10 | 6043 |
| SL 65 AMG (230) | 6.0 | 450 | 03.04 - | M 275.981 | Twin Spark | 12 | IFR6Q-G | 5648 | | IFR6Q-G | 5648 |
| SL 73 AMG (129) | 7.3 | 386 | 99 - | M 120.E73 | | 12 | PFR5R-11 | 4292 | | LPG 1 | 1496 |
| SLK 200 (170) | 2.0 | 100 | 09.96 - | M 111.946 | | 4 | BKUR5ET | 2789 | 29 | LPG 1 | 1496 |
| SLK 200 Kompressor (170) | 2.0 | 120 | 03.00 - | M 111.958 | | 4 | IFR6D10 | 5344 | | LPG 1 | 1496 |
| SLK 200 Kompressor (170) | 2.0 | 141 | 09.96 - 02.00 | M 111.943 | | 4 | BKUR6ET-10 | 2397 | 24 | LPG 1 | 1496 |



ℓ kW

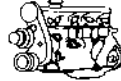

Cyl.

Order-
No.VLINE
No.LPG/CNG
D-PowerOrder-
No.**MERCEDES**

| | | | | | | | | | | |
|-----------------------------|-----|-----|---------------|-----------------------|---|------------|------|----|------------|------|
| SLK 200 Kompressor (171) | 1.8 | 120 | 04.04 - 11.06 | M 271.944 -> 30853899 | 4 | ILFR6A | 3588 | | ILFR6A | 3588 |
| SLK 230 Kompressor (170) | 2.3 | 142 | 09.96 - 02.00 | M 111.973 | 4 | BKUR6ET-10 | 2397 | 24 | LPG 1 | 1496 |
| SLK 230 Kompressor (170) | 2.3 | 145 | 03.00 - | M 111.983 | 4 | IFR6D10 | 5344 | | LPG 1 | 1496 |
| SLK 280 Kompressor (171) | 3.0 | 170 | 01.05 - | M 272.942 | 6 | PLKR7A | 4288 | | PLKR7A | 4288 |
| SLK 32 AMG (170) | 3.2 | 260 | 01 - | M 112.960 Twin Spark | 6 | IFR6D10 | 5344 | | LPG 1 | 1496 |
| SLK 32 AMG Kompressor (170) | 3.2 | 260 | 11.00 - | M 112.960 Twin Spark | 6 | IFR6D10 | 5344 | | LPG 1 | 1496 |
| SLK 320 (170) | 3.2 | 160 | 03.00 - | M 112.947 Twin Spark | 6 | PFR5R-11 | 4292 | | LPG 1 | 1496 |
| SLK 350 (171) | 3.5 | 200 | 06.04 - | M 272.963 | 6 | PLKR7A | 4288 | | PLKR7A | 4288 |
| SLK 350 (171) | 3.5 | 224 | 01.08 - | M 272.969 | 6 | PLKR7A | 4288 | | PLKR7A | 4288 |
| SLK 55 AMG (171) | 5.5 | 265 | 04.04 - | M 113.989 Twin Spark | 8 | IFR6D10 | 5344 | | LPG 1 | 1496 |
| SLR Mc Laren (199) | 5.4 | 460 | 04.04 - 01.10 | M 155.980 Twin Spark | 8 | ILFR6A | 3588 | | ILFR6A | 3588 |
| Sprinter 208 CDI | 2.1 | 60 | 04.00 - | | 4 | Y-745U | 6346 | | D-POWER 11 | 6346 |
| Sprinter 208 D | 2.3 | 58 | 04.95 - | OM 601.... | 4 | Y-916J | 5906 | | D-POWER 6 | 5906 |
| Sprinter 209 CDI 906 | 2.1 | 65 | 06.06 - | OM 646.984 | 4 | Y-745U | 6346 | | D-POWER 11 | 6346 |
| Sprinter 209 CDI 906 | 2.1 | 80 | 06.06 - | OM 646.985 | 4 | Y-745U | 6346 | | D-POWER 11 | 6346 |
| Sprinter 209 CDI 906 | 3.0 | 135 | 06.06 - | OM 642.992 | 4 | CZ303 | 7865 | | D-POWER 54 | 7865 |
| Sprinter 209 CDI 906 | 3.0 | | 06.06 - | OM 642.896 | 4 | CZ303 | 7865 | | D-POWER 54 | 7865 |
| Sprinter 211 CDI | 2.1 | 80 | 04.00 - | | 4 | Y-745U | 6346 | | D-POWER 11 | 6346 |
| Sprinter 212 D | 2.9 | 90 | 04.95 - | OM 602.980.10 | 5 | Y-923U | 3380 | | D-POWER 1 | 7906 |
| | | | | DELA ->9849 | | | | | | |
| Sprinter 212 D | 2.9 | 90 | 04.95 - | OM 602.980.10 | 5 | Y-929U | 1749 | | D-POWER 41 | 1749 |
| | | | | DELA 9850-> | | | | | | |
| Sprinter 212 D | 2.9 | 90 | 04.95 - | OM 602.980.12 | 5 | Y-923U | 3380 | | D-POWER 1 | 7906 |
| | | | | DELA ->136 | | | | | | |
| Sprinter 212 D | 2.9 | 90 | 04.95 - | OM 602.980.12 | 5 | Y-929U | 1749 | | D-POWER 41 | 1749 |
| | | | | DELA 137 -> | | | | | | |
| Sprinter 213 CDI | 2.1 | 95 | 04.00 - | | 4 | Y-745U | 6346 | | D-POWER 11 | 6346 |
| Sprinter 214 | 2.3 | 105 | 04.95 - | M 111.979 | 4 | BKUR5ET | 2789 | 29 | LPG 1 | 1496 |
| Sprinter 216 CDI | 2.7 | 115 | 04.00 - | | 4 | Y-745U | 6346 | | D-POWER 11 | 6346 |
| Sprinter 308 CDI | 2.1 | 60 | 04.00 - | | 4 | Y-745U | 6346 | | D-POWER 11 | 6346 |
| Sprinter 308 D | 2.3 | 58 | 04.95 - 00 | OM 601..... | 4 | Y-916J | 5906 | | D-POWER 6 | 5906 |
| Sprinter 311 CDI | 2.1 | 80 | 04.00 - | OM 611.981 | 4 | Y-745U | 6346 | | D-POWER 11 | 6346 |
| Sprinter 312 D | 2.9 | 90 | 04.95 - 04.00 | OM 602.980.10 | 5 | Y-923U | 3380 | | D-POWER 1 | 7906 |
| | | | | DELA ->9849 | | | | | | |
| Sprinter 312 D | 2.9 | 90 | 04.95 - 04.00 | OM 602.980.10 | 5 | Y-929U | 1749 | | D-POWER 41 | 1749 |
| | | | | DELA9850-> | | | | | | |
| Sprinter 312 D | 2.9 | 90 | 04.95 - 04.00 | OM 602.980.12 | 5 | Y-923U | 3380 | | D-POWER 1 | 7906 |
| | | | | DELA ->136 | | | | | | |
| Sprinter 312 D | 2.9 | 90 | 04.95 - 04.00 | OM 602.980.12 | 5 | Y-929U | 1749 | | D-POWER 41 | 1749 |
| | | | | DELA 137 -> | | | | | | |
| Sprinter 313 CDI | 2.1 | 95 | 04.00 - | | 4 | Y-745U | 6346 | | D-POWER 11 | 6346 |
| Sprinter 314 | 2.3 | 105 | 04.95 - | M 111.979 | 4 | BKUR5ET | 2789 | 29 | LPG 1 | 1496 |
| Sprinter 316 CDI | 2.7 | 115 | 04.00 - | | 4 | Y-745U | 6346 | | D-POWER 11 | 6346 |
| Sprinter 412 D | 2.9 | 90 | 04.95 - | OM 602.980.10 | 5 | Y-923U | 3380 | | D-POWER 1 | 7906 |
| | | | | DELA ->9849 | | | | | | |
| Sprinter 412 D | 2.9 | 90 | 04.95 - | OM 602.980.10 | 5 | Y-929U | 1749 | | D-POWER 41 | 1749 |
| | | | | DELA 9850 -> | | | | | | |
| Sprinter 412 D | 2.9 | 90 | 04.95 - | OM 602.980.12 | 5 | Y-923U | 3380 | | D-POWER 1 | 7906 |
| | | | | DELA ->136 | | | | | | |
| Sprinter 412 D | 2.9 | 90 | 04.95 - | OM 602.980.12 | 5 | Y-929U | 1749 | | D-POWER 41 | 1749 |
| | | | | DELA 137 -> | | | | | | |
| Unimog 100 L | 2.9 | 71 | 11.92 - | OM 602.948 | 5 | Y-916J | 5906 | | D-POWER 6 | 5906 |



l kW

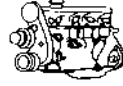

Cyl.

Order-
No. No.

VALVE

LPG/CNG
D-PowerOrder-
No.**MERCEDES**

| | | | | | | | | | | | |
|----------------------|-----|-----|--------------|----------------------|---|---|------------|------|----|------------|------|
| Unimog 600/650 | 2.4 | 38 | 01.88 - | OM 616. | 4 | █ | Y-924J | 7906 | | D-POWER 1 | 7906 |
| Unimog U 90 | 3.0 | 65 | 11.92 - | OM 602.941 | 5 | █ | Y-916J | 5906 | | D-POWER 6 | 5906 |
| V 220 CDI | 2.2 | 90 | 03.99 - | OM 611.980 | 4 | █ | Y-745U | 6346 | | D-POWER 11 | 6346 |
| V 230 | 2.3 | 105 | 09.96 - | M 111.978 | 4 | | BKR6EK | 2288 | 20 | LPG 1 | 1496 |
| V 230 TD | 2.3 | 72 | 09.96 - | OM 601.970 | 4 | █ | Y-916J | 5906 | | D-POWER 6 | 5906 |
| V 280 VR6 | 2.8 | 125 | 98 - | M 104.900(AFS) | 6 | | BKR5EKUP | 2890 | | | |
| Vaneo (414) | 1.6 | 60 | 01.02 - | M 166.961 | 4 | | BKUR5ET | 2789 | 29 | LPG 1 | 1496 |
| Vaneo (414) | 1.6 | 75 | 01.02 - | M 166.961 | 4 | | BKUR5ET | 2789 | 29 | LPG 1 | 1496 |
| Vaneo (414) | 1.9 | 92 | 01.02 - | M 166.991 | 4 | | BKUR5ET | 2789 | 29 | LPG 1 | 1496 |
| Vaneo CDI (414) | 1.7 | 55 | 01.02 - | OM 668.914 | 4 | █ | Y-745U | 6346 | | D-POWER 11 | 6346 |
| Vaneo CDI (414) | 1.7 | 67 | 01.02 - | OM 668.914 | 4 | █ | Y-745U | 6346 | | D-POWER 11 | 6346 |
| Viano 2.0I CDI (639) | 2.2 | 80 | 07.03 - | OM 646.982 | 4 | █ | Y-745U | 6346 | | D-POWER 11 | 6346 |
| Viano 2.2I CDI (639) | 2.2 | 110 | 09.03 - | OM 646.983 | 4 | █ | Y-745U | 6346 | | D-POWER 11 | 6346 |
| Viano 3.0I (639) | 3.2 | 140 | 09.03 - | M 112.951 Twin Spark | 6 | | PFR5R-11 | 4292 | | LPG 1 | 1496 |
| Viano 3.0I CDI (639) | 3.0 | 150 | 05 - | OM 642.990 | 6 | █ | Y8002AS | 6287 | | D-POWER 51 | 6287 |
| Viano 3.2I (639) | 3.2 | 190 | 09.05 - | M 272.978 | 6 | | PLKR7A | 4288 | | PLKR7A | 4288 |
| Viano 3.5I (639) | 3.7 | 170 | 01.05 - | M 112.976 Twin Spark | 6 | | PFR5R-11 | 4292 | | LPG 1 | 1496 |
| Vito 113 | 2.0 | 95 | 03.96 - | M 111.948/950 | 4 | | BKUR5ET-10 | 7553 | | LPG 1 | 1496 |
| Vito 114 | 2.3 | 105 | 03.96 -07.03 | M 111.978 | 4 | | BKUR5ET-10 | 7553 | | LPG 1 | 1496 |
| Vito 108 D | 2.3 | 60 | 02.96 - | OM 601.942 | 4 | █ | Y-916J | 5906 | | D-POWER 6 | 5906 |
| Vito 110 D | 2.3 | 72 | 02.96 - | OM 601.970 | 4 | █ | Y-916J | 5906 | | D-POWER 6 | 5906 |

MERCURY

| | | | | | | | | | | | |
|--------|-----|--|---------|----------------|---|-----|-------|------|--|---------|------|
| Cougar | 3.3 | | 80 - 82 | B 1 bbl CID200 | 6 | 1,1 | WR5 | 1071 | | WR5IX | 7510 |
| Cougar | 3.8 | | 82 - | 3 2 bbl CID232 | 6 | 0,9 | FR4 | 5188 | | | |
| Cougar | 3.8 | | 83 - | 3 2 bbl CID232 | 6 | 1,1 | TR5-1 | 2321 | | TR5-1IX | 7243 |
| Cougar | 4.2 | | 80 - 82 | D 2 bbl CID255 | 8 | 1,5 | UR45 | 2451 | | UR5IX | 7177 |
| Cougar | 5.8 | | 80 - | G 2 bbl CID351 | 8 | 1,5 | UR45 | 2451 | | UR5IX | 7177 |

MG

| | | | | | | | | | | | |
|-------------------|-----|-----|---------------|--------------|---|-----|----------|------|---|------------|------|
| Express 1.4 | 1.4 | | 02.03 - | K Series | 4 | 1,1 | PFR6N-11 | 3546 | | LPG 1 | 1496 |
| Express 1.8 | 1.8 | | 02.03 - | K Series | 4 | 1,1 | PFR6N-11 | 3546 | | LPG 1 | 1496 |
| Express 2.0 | 2.0 | | 02.03 - | K Series | 4 | █ | Y-730U | 6704 | | D-POWER 17 | 6704 |
| MGF 1.6 | 1.6 | 81 | 02.00 - | K Series | 4 | 1,1 | PFR6N-11 | 3546 | | LPG 1 | 1496 |
| MGF Roadster | 1.8 | 88 | 11.95 - | NPI | 4 | 1,1 | PFR6N-11 | 3546 | | LPG 1 | 1496 |
| MGF Roadster | 1.8 | 106 | 11.95 - | VV10 | 4 | 1,1 | PFR6N-11 | 3546 | | LPG 1 | 1496 |
| MGF Trophy 160 SE | 1.8 | 116 | 02.95 - | K Series VVC | 4 | 1,0 | PFR6N-11 | 3546 | | LPG 1 | 1496 |
| MGTF 1.6 | 1.6 | 85 | 03.02 - | K Series | 4 | 1,0 | PFR6N-11 | 3546 | | LPG 1 | 1496 |
| MGTF 1.8 | 1.8 | 88 | 03.02 - | K Series | 4 | 1,0 | PRF6N-11 | 3546 | | | |
| MGTF 1.8 | 1.8 | 99 | 03.02 - | K Series | 4 | 1,0 | PFR6N-11 | 3546 | | LPG 1 | 1496 |
| MGTF 1.8 | 1.8 | 118 | 03.02 - | K Series | 4 | 1,0 | PFR6N-11 | 3546 | | LPG 1 | 1496 |
| RV 8 | 3.9 | 140 | 10.92 - 10.95 | Rover V8 Efi | 8 | 0,8 | BPR6ES | 7822 | 2 | LPG 2 | 1497 |
| ZR 105 | 1.4 | 74 | 06.01 - | K | 4 | 1,1 | PFR6N-11 | 3546 | | LPG 1 | 1496 |
| ZR 105 | 1.4 | 74 | 06.01 - | K | 4 | 1,1 | PFR6N-11 | 3546 | | LPG 1 | 1496 |
| ZR 120 | 1.8 | 85 | 06.01 - | K | 4 | 1,1 | PFR6N-11 | 3546 | | LPG 1 | 1496 |
| ZR 120 | 1.8 | 85 | 06.01 - | K | 4 | 1,1 | PFR6N-11 | 3546 | | LPG 1 | 1496 |
| ZR 160 | 1.8 | 116 | 06.01 - | K VVC | 4 | 1,1 | PFR6N-11 | 3546 | | LPG 1 | 1496 |
| ZR TD | 2.0 | | 06.01 - | | 4 | █ | Y-730U | 6704 | | D-POWER 17 | 6704 |
| ZR TD | 2.0 | | 12.02 - | | 4 | █ | Y-730U | 6704 | | D-POWER 17 | 6704 |
| ZS 110 | 1.6 | | 07.03 - | K Series | 4 | 1,1 | PFR6N-11 | 3546 | | LPG 1 | 1496 |
| ZS 120 | 1.8 | 85 | 06.01 - | K | 4 | 1,1 | PFR6N-11 | 3546 | | LPG 1 | 1496 |
| ZS 120 | 1.8 | 88 | 06.01 - | K | 4 | 1,1 | PFR6N-11 | 3546 | | LPG 1 | 1496 |



ℓ kW

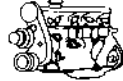

Cyl.

Order-
No.VLINE
No.LPG/CNG
D-PowerOrder-
No.**MG**

| | | | | | | | | | | | |
|----------------|-----|-----|---------|------------|---|-----|----------|------|--|------------|------|
| ZS 180 | 2.5 | 132 | 06.01 - | KV6 | 6 | 1,1 | PFR6N-11 | 3546 | | LPG 1 | 1496 |
| ZS TD | 2.0 | | 08.02 - | | 4 | ▣ | Y-730U | 6704 | | D-POWER 17 | 6704 |
| ZS TD | 2.0 | | 12.02 - | | 4 | ▣ | Y-730U | 6704 | | D-POWER 17 | 6704 |
| ZT 120 | 1.8 | | 07.03 - | K Series | 4 | 1,1 | PFR6N-11 | 3546 | | LPG 1 | 1496 |
| ZT 160 | 2.5 | 116 | 06.01 - | KV6 | 6 | 1,1 | PFR6N-11 | 3546 | | LPG 1 | 1496 |
| ZT 160 | 2.5 | 116 | 06.01 - | KV6 | 6 | 1,1 | PFR6N-11 | 3546 | | LPG 1 | 1496 |
| ZT 160 Turbo | 1.8 | | 10.02 - | K Series | 4 | 1,1 | PFR6N-11 | 3546 | | LPG 1 | 1496 |
| ZT 190 | 2.5 | 138 | 06.01 - | KV6 | 6 | 1,1 | PFR6N-11 | 3546 | | LPG 1 | 1496 |
| ZT 190 | 2.5 | 138 | 06.01 - | KV6 | 6 | 1,1 | PFR6N-11 | 3546 | | LPG 1 | 1496 |
| ZT CDTi | 2.0 | | 07.02 - | M47R (BMW) | 4 | ▣ | Y-507J | 2691 | | D-POWER 32 | 2691 |
| ZT CDTi | 2.0 | | 10.02 - | M47R (BMW) | 4 | ▣ | Y-507J | 2691 | | D-POWER 32 | 2691 |
| ZT-T 160 | 2.5 | 116 | 06.01 - | KV6 | 6 | 1,1 | PFR6N-11 | 3546 | | LPG 1 | 1496 |
| ZT-T 160 | 2.5 | 116 | 06.01 - | KV6 | 6 | 1,1 | PFR6N-11 | 3546 | | LPG 1 | 1496 |
| ZT-T 160 Turbo | 1.8 | | 10.02 - | K series | 4 | 1,1 | PFR6N-11 | 3546 | | LPG 1 | 1496 |
| ZT-T 190 | 2.5 | 138 | 06.01 - | KV6 | 6 | 1,1 | PFR6N-11 | 3546 | | LPG 1 | 1496 |
| ZT-T CDTi | 2.0 | | 07.02 - | M47R (BMW) | 4 | ▣ | Y-507J | 2691 | | D-POWER 32 | 2691 |
| ZT-T CDTi | 2.0 | | 10.02 - | M47R (BMW) | 4 | ▣ | Y-507J | 2691 | | D-POWER 32 | 2691 |

MINI

| | | | | | | | | | | | |
|-----------------------|-----|-----|---------------|---------|---|-----|-------------|------|----|-------------|------|
| Mini Cooper | 1.6 | 85 | 04.01 - | W10 B16 | 4 | | BKR6EQUP | 3199 | 30 | LPG 1 | 1496 |
| Mini Cooper | 1.6 | 88 | 09.06 - | N12 B16 | 4 | 0,8 | PLZKBR7A-G | 5843 | | PLZKBR7A-G | 5843 |
| Mini Cooper D | 1.6 | 81 | 03.07 - | W16 D16 | 4 | ▣ | YE05 | 5207 | | | |
| Mini Cooper S | 1.6 | 128 | 09.06 - | N14 B16 | 4 | 0,8 | PLZKBR7A-G | 5843 | | PLZKBR7A-G | 5843 |
| Mini Cooper S 16V | 1.6 | 125 | 12.01 - | W11 B16 | 4 | | BKR6EQUP | 3199 | 30 | LPG 1 | 1496 |
| Mini Cooper S 16V JCW | 1.6 | 147 | 01.03 - | W11 B16 | 4 | | BKR7EQUP | 4285 | | | |
| Mini Cooper S 16V JCW | 1.6 | 155 | 05.08 - | N14 B16 | 4 | 0,8 | ILZKBR7A-8G | 5992 | | ILZKBR7A-8G | 5992 |
| Mini D | 1.4 | 55 | 03.03 - | W17 D14 | 4 | ▣ | Y-542J | 5513 | | D-POWER 45 | 5513 |
| Mini D | 1.4 | 65 | 03.03 - | W17 D14 | 4 | ▣ | Y-542J | 5513 | | D-POWER 45 | 5513 |
| Mini One | 1.4 | 55 | 09.02 - 12.04 | W10 B14 | 4 | | BKR6EQUP | 3199 | 30 | LPG 1 | 1496 |
| Mini One | 1.4 | 70 | 03.07 - | N12 B14 | 4 | 0,8 | PLZKBR7A-G | 5843 | | PLZKBR7A-G | 5843 |
| Mini One | 1.6 | 55 | 03.10 - | N16 B16 | 4 | 0,8 | PLZKBR7A-G | 5843 | | PLZKBR7A-G | 5843 |
| Mini One | 1.6 | 66 | 04.01 - | W10 B16 | 4 | | BKR6EQUP | 3199 | 30 | LPG 1 | 1496 |
| Mini One | 1.6 | 72 | 03.10 - | N16 B16 | 4 | 0,8 | PLZKBR7A-G | 5843 | | PLZKBR7A-G | 5843 |

MINI

| | | | | | | | | | | | |
|---------------------------------|-----|-----|---------------|----------------|---|-----|-----------|-------|----|------------|-------|
| 1300 Mini Bus / Van | | | | 4D56 | 4 | ▣ | Y-115T1 | 2189 | | | |
| 1300 Mini Bus / Van | | | | 4D56S-QGS Type | 4 | | only OES | | | | |
| 2000 GTX | 2.0 | | 94 - | 4G63 | 4 | 1,1 | BKR5E-11 | 6953 | 33 | LPG 1 | 1496 |
| 3000 GT | 3.0 | 210 | 09.92 - 00 | 6G72/T DOHC | 6 | 1,1 | PFR6J-11 | 2743 | | PFR6J | 2645 |
| 3000 GT | 3.0 | | 97 - | 6G7 | 6 | 1,1 | PFR6J-11 | 2743 | | PFR6J | 2645 |
| 3000 GT | 3.0 | | 95 - 00 | 6G72 MPI TC | 6 | 1,1 | PFR6J-11 | 2743 | | PFR6J | 2645 |
| Airtrek | 2.0 | 93 | 02 - | 4G63 MPI | 4 | 1,1 | BKR6E-11 | 2756 | 14 | LPG 1 | 1496 |
| Airtrek | 2.0 | | 06.02 - | 4G63 | 4 | 0,7 | PGR6A | 4984 | | PGR7A | 3200 |
| Airtrek | 2.4 | | 01.03 - | 4G64 | 4 | 1,1 | BKR5E-11 | 6953 | 33 | LPG 1 | 1496 |
| ASX 1.6 GA1W | 1.6 | 86 | 06.10 - | 4A92 | 4 | 1,1 | DILFR5A11 | 93759 | | DILFR5A11 | 93759 |
| ASX 2.0 GA2W | 2.0 | 110 | 06.10 - | 4B11 | 4 | 0,8 | FR6EI | 2687 | | FR6EI | 2687 |
| Canter | | | - 84 | 4D56 | 4 | ▣ | Y-115T1 | 2189 | | | |
| Canter | | | - 84 | 4DR51 | 4 | ▣ | Y-251 | 2026 | | | |
| Canter | 3.0 | 92 | 09.01 - 02.05 | 4M42-OAT | | ▣ | Y1007J | 3040 | | D-POWER 59 | 3040 |
| Canter | 3.0 | 92 | 09.01 - 02.05 | 4M42-OAT | | ▣ | Y1007J | 3040 | | D-POWER 59 | 3040 |
| Canter (N-FE301, 311, 321, 331) | | | 10.85 - 10.03 | 4D30 | 4 | ▣ | Y-971M | 5035 | | | |
| Canter (N-FE401) | | | 10.85 - 10.03 | 4D30 | 4 | ▣ | Y-971M | 5035 | | | |



ℓ kW



Cyl.

Order-
No. No.LPG/CNG
D-PowerOrder-
No.**MITSUBISHI**

| | | | | | | | | | | | |
|------------------------|-----|-----|---------------|-----------------------|---|-----|-----------|------|----|------------|------|
| Carisma | 1.6 | | 97 - 99 | 4G92 SOHC | 4 | 1,1 | BKR6E-11 | 2756 | 14 | LPG 1 | 1496 |
| Carisma | 1.8 | | 97 - 00 | 4G93 SOHC | 4 | 1,1 | BKR6E-11 | 2756 | 14 | LPG 1 | 1496 |
| Carisma | 1.9 | 59 | | F9QT | 4 | ▣ | Y-732J | 5605 | | D-POWER 4 | 5605 |
| Carisma GDI | 1.8 | 92 | 09.97 - | 4G93 GDI | 4 | 0,6 | IZFR6B | 3116 | | IZFR6B | 3116 |
| Carisma 1.9 DI-D(DA..) | 1.9 | 75 | 09.00 - | | 4 | ▣ | Y-732J | 5605 | | D-POWER 4 | 5605 |
| Carisma 1.9 DI-D(DA..) | 1.9 | 85 | 09.00 - | | 4 | ▣ | Y-732J | 5605 | | D-POWER 4 | 5605 |
| Carisma 1600 DAO | 1.6 | 66 | 07.95 - 99 | 4G92 | 4 | 1,1 | BKR6E-11 | 2756 | 14 | LPG 1 | 1496 |
| Carisma 1800 DAO | 1.8 | 85 | 09.95 - | 4G93 | 4 | 1,1 | BKR6E-11 | 2756 | 14 | LPG 1 | 1496 |
| Carisma 1800 DAO | 1.8 | 103 | 09.95 - | 4G93 | 4 | 1,1 | BKR6E-11 | 2756 | 14 | LPG 1 | 1496 |
| Carisma Elegance GDI | 1.8 | 92 | 99 - | 4G93 GDI | 4 | 0,6 | IZFR6B | 3116 | | IZFR6B | 3116 |
| Carisma TD | 1.9 | 66 | 10.96 - | F8Q | 4 | ▣ | Y-933J | 7947 | | D-POWER 25 | 7947 |
| Challenger | 2.5 | | 11.98 - | | 4 | ▣ | Y-733J | 6592 | | D-POWER 13 | 6592 |
| Champ 1300 | 1.3 | | 94 - | 4G13 | 4 | 0,8 | BP5ES | 6511 | 8 | LPG 2 | 1497 |
| Champ 1500 | 1.5 | | 94 - | 4G15 | 4 | 1,1 | BPR5ES-11 | 4424 | | LPG 2 | 1497 |
| Colt | 1.2 | | 01.84 - 07.84 | 4G16 | 4 | 0,9 | BPR5ES | 7422 | 6 | LPG 2 | 1497 |
| Colt | 1.5 | | 01.84 - 07.84 | 4G15 | 4 | 0,9 | BPR5ES | 7422 | 6 | LPG 2 | 1497 |
| Colt (5) | 1.6 | 66 | 03.96 - 03 | 4G92 | 4 | | BKR6E-11 | 2756 | 14 | LPG 1 | 1496 |
| Colt (6) Z31A / Z32A | 1.1 | 55 | 04.05 - | 3A91 12V | 3 | | LF6C-11 | 5788 | | | |
| Colt (6) Z33A / Z34A | 1.3 | 70 | 04.05 - | 4A90 16V | 4 | | LF6C-11 | 5788 | | | |
| Colt (6) Z36A | 1.5 | 80 | 04.05 - | 4A91 16V | 4 | | ILZFR6C-K | 6645 | | ILZFR6C-K | 6645 |
| Colt CZC (6) Z36A | 1.5 | 80 | 04.05 - 07.08 | 4A91 16V | 4 | 0,8 | ILZFR6C-K | 6645 | | ILZFR6C-K | 6645 |
| Colt CZC (6) Z37A | 1.5 | 110 | 03.05 - 07.08 | 4G15T DOHC | 4 | 0,8 | ILZFR6C-K | 6645 | | ILZFR6C-K | 6645 |
| Colt CZT (6) Z37A | 1.5 | 110 | 03.05 - | 4G15T DOHC | 4 | | ILZFR6C-K | 6645 | | ILZFR6C-K | 6645 |
| Colt 1200 C10 (3) | 1.2 | 40 | 85 - 88 | 4G16 | 4 | 0,8 | BPR6ES | 7822 | 2 | LPG 2 | 1497 |
| Colt 1200 (1) | 1.2 | 40 | - 84 | 4G11 | 4 | | BPR5ES | 7422 | 6 | LPG 2 | 1497 |
| Colt 1300 (4) | 1.3 | 55 | 93 - 94 | 4G13 / MPI Cat. | 4 | | BPR6ES-11 | 4824 | 13 | LPG 2 | 1497 |
| Colt 1300 (4) | 1.3 | | 95 - | 4G13 | 4 | | BPR5ES-11 | 4424 | | LPG 2 | 1497 |
| Colt 1300 (4) | 1.3 | | 92 - | 4G13 / MPI | 4 | | BPR5ES-11 | 4424 | | LPG 2 | 1497 |
| Colt 1300 (3) | 1.3 | | 89 - 92 | 4G13 | 4 | | BPR6ES-11 | 4824 | 13 | LPG 2 | 1497 |
| Colt 1300 (5) | 1.3 | 55 | 03.96 - | 4G13 | 4 | 1,1 | BPR5ES-11 | 4424 | | LPG 2 | 1497 |
| Colt 1300 (5) | 1.3 | 60 | 09.00 - | | 4 | 1,1 | BKR6E-11 | 2756 | 14 | LPG 1 | 1496 |
| Colt 1300 (5) | 1.3 | | 97 - | 4G13 | 4 | 1,1 | BPR5ES-11 | 4424 | | LPG 2 | 1497 |
| Colt 1400 (2) | 1.4 | | - 87 | | 4 | | BPR6ES | 7822 | 2 | LPG 2 | 1497 |
| Colt 1500 (4) | 1.5 | 69 | 94 - | 4G15 | 4 | | BP5ES | 6511 | 8 | LPG 2 | 1497 |
| Colt 1500 (3) | 1.5 | | - 12.93 | 4G15 | 4 | | BPR6ES | 7822 | 2 | LPG 2 | 1497 |
| Colt 1500 (3) | 1.5 | | 91 - | 4G15 Cat. | 4 | | BPR6ES-11 | 4824 | 13 | LPG 2 | 1497 |
| Colt 1600 (4) | 1.6 | 83 | 94 - 95 | 4G92 MPI | 4 | | BKR6E-11 | 2756 | 14 | LPG 1 | 1496 |
| Colt 1600 (4) | 1.6 | | 92 - 93 | 4G92 | 4 | | BKR6E-11 | 2756 | 14 | LPG 1 | 1496 |
| Colt 1600 (4) | 1.6 | | 95 - 96 | 4G92 MPI MVV | 4 | | BKR6E-11 | 2756 | 14 | LPG 1 | 1496 |
| Colt 1600 (2) | 1.6 | | - 92 | | 4 | | BPR6ES | 7822 | 2 | LPG 2 | 1497 |
| Colt 1600 (5) | 1.6 | 66 | 03.96 - | 4G92 | 4 | 1,1 | BKR6E-11 | 2756 | 14 | LPG 1 | 1496 |
| Colt 1600 (5) | 1.6 | | 97 - | 4G9 MVV | 4 | 1,1 | BKR6E-11 | 2756 | 14 | LPG 1 | 1496 |
| Colt 1600 (5) | 1.6 | | 97 - | 4G9(not MVV Magermix) | 4 | 1,1 | BKR6E-11 | 2756 | 14 | LPG 1 | 1496 |
| Colt 1600 16V (4) | 1.6 | 83 | 12.91 - | 4G92 | 4 | 0,8 | BPR6ES | 7822 | 2 | LPG 2 | 1497 |
| Colt 1600 Turbo (2) | 1.6 | | 85 - 85 | | 4 | 0,8 | BPR7ES | 2023 | 19 | BPR8EIX | 6684 |
| Colt 1600 Turbo (2) | 1.6 | | 01.86 - 88 | | 4 | 0,8 | BPR6ES | 7822 | 2 | LPG 2 | 1497 |
| Colt 1800 (3) | 1.8 | | | 4G67 Cat. | 4 | | BPR7ES | 2023 | 19 | BPR8EIX | 6684 |
| Colt 1800 (1) | 1.8 | | - 84 | 4G67 Cat. | 4 | | BPR7ES | 2023 | 19 | BPR8EIX | 6684 |
| Colt 1800 GTI 16V (4) | 1.8 | 103 | 94 - | 4G93 MPI | 4 | 1,1 | BKR6E-11 | 2756 | 14 | LPG 1 | 1496 |
| Colt DID (6) Z38A | 1.5 | 50 | 04.05 - 09.08 | 639 938 | 4 | ▣ | YE13 | 8643 | | | |
| Colt DID (6) Z39A | 1.5 | 70 | 04.05 - 09.08 | 639 939 | 3 | ▣ | YE13 | 8643 | | | |
| Cordia | 1.6 | | 82 - | 4G32 | 4 | 0,9 | BPR5ES | 7422 | 6 | LPG 2 | 1497 |



ℓ kW

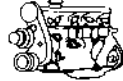

Cyl.

Order-
No.VLINE
No.LPG/CNG
D-PowerOrder-
No.**MITSUBISHI**

| | | | | | | | | | | | |
|--------------------------------|-----|-----|---------------|-------------------|---|-----|-----------|------|----|---------|------|
| Cordia | 1.6 | | 82 - 84 | 4G32 TURBO | 4 | 0,8 | BPR6ES | 7822 | 2 | LPG 2 | 1497 |
| Cordia Turbo | 1.6 | 84 | - 84 | 4G32 | 4 | 0,8 | BPR6ES | 7822 | 2 | LPG 2 | 1497 |
| Cordia Turbo | 1.8 | 100 | 85 - 88 | 4G62 / G62B Turbo | 4 | 0,8 | BR7ES | 5122 | | BR8EIX | 5044 |
| Debonair 3000 | | | - 88 | 6G72 | 4 | 0,8 | BP5ES | 6511 | 8 | LPG 2 | 1497 |
| Debonair 3000 | | | 89 - 90 | 6G72 | 4 | 1,1 | PGR6A-11 | 3738 | | PGR7A | 3200 |
| Debonair 3000 | | | 91 - | 6G72 | 4 | 0,8 | BP5ES | 6511 | 8 | LPG 2 | 1497 |
| Diamante (F31A, F41A) 2500 GDI | 2.5 | | 09.99 - 09.01 | 6G73 | | 0,8 | IZFR5C | 7748 | | IZFR5C | 7748 |
| Diamante (F36A, F46A) 3000 GDI | 3.0 | | 09.99 - 09.01 | 6G72 | 6 | 0,8 | IZFR5C | 7748 | | IZFR5C | 7748 |
| Diamante 3000 | 3.0 | | 94 - | 6G72 MPI DOHC | 6 | 0,8 | BK6E | 3536 | | LPG 1 | 1496 |
| Diamante 3000 | 3.0 | | 94 - | 6G72 MPI SOHC | 6 | 1,1 | BPR6ES-11 | 4824 | 13 | LPG 2 | 1497 |
| Eclipse | 2.0 | | 97 - | 4G6 | 4 | 1,1 | BPR6ES-11 | 4824 | 13 | LPG 2 | 1497 |
| Eclipse V6 24V | 3.0 | 147 | 07.03 - | 4G72 SOHC MPI | 6 | 0,8 | FR6EI | 2687 | | | |
| Eclipse 2000 | 2.0 | 110 | 91 - 10.95 | 4G63 MPI DOHC | 4 | 0,8 | BPR7ES | 2023 | 19 | BPR8EIX | 6684 |
| Eclipse 2000 D30 | 2.0 | 107 | 11.95 - | 4G63 | 4 | 1,1 | BUR7EA-11 | 7031 | | | |
| Eclipse 2400 | 2.4 | 105 | 09.98 - | 4G64 | 4 | 1,1 | BKR5E-11 | 6953 | 33 | LPG 1 | 1496 |
| Eterna 2000 (E74A, E84A) | 2.0 | | 05.92 - 10.94 | 6A12 | 4 | 0,8 | PFR6J | 2645 | | PFR6J | 2645 |
| Eterna 2500 (EC5A) | 2.5 | | 08.96 - | 6A13 | 4 | 0,8 | PFR6J | 2645 | | PFR6J | 2645 |
| Expo 1800 LRV | 1.8 | | 94 - | 4G93 MPI | 4 | 1,1 | BKR5E-11 | 6953 | 33 | LPG 1 | 1496 |
| Expo 2400 / LRV | 2.4 | 113 | 94 - | 4G64 MPI SOHC | 4 | 1,1 | BKR5E-11 | 6953 | 33 | LPG 1 | 1496 |
| Express | 2.0 | | | 4G63 | 4 | 0,7 | BP6ES | 7811 | 4 | LPG 2 | 1497 |
| Express | 2.4 | | | 4G64 | 4 | 0,7 | BP6ES | 7811 | 4 | LPG 2 | 1497 |
| FTO | 1.8 | | | 4G93 | 4 | 1,1 | BKR5E-11 | 6953 | 33 | LPG 1 | 1496 |
| FTO with MIVEC Front Bank | 2.0 | | | 6A12 MIVEC | 4 | | BKR7EKC-N | 2095 | | | |
| FTO with MIVEC Rear Bank | 2.0 | | | 6A12 MIVEC | 4 | | PFR7M | 4877 | | PFR7M | 4877 |
| FTO without MIVEC Front Bank | 2.0 | | | 6A12 | 4 | 1,1 | BKR6E-11 | 2756 | 14 | LPG 1 | 1496 |
| FTO without MIVEC Rear Bank | 2.0 | | | 6A12 | 4 | 1,1 | PFR6G-11 | 5555 | | PFR7G | 4364 |
| Galant | 1.6 | | 80 - 84 | 4G32 | 4 | 0,9 | BPR5ES | 7422 | 6 | LPG 2 | 1497 |
| Galant | 2.0 | | 80 - 84 | 4G63 | 4 | 0,8 | BPR6ES | 7822 | 2 | LPG 2 | 1497 |
| Galant | 2.0 | | 85 - 87 | 4G63 | 4 | 0,8 | BPR7ES | 2023 | 19 | BPR7EIX | 4055 |
| Galant | 2.0 | | 91 - 91 | 4G63 | 4 | 0,8 | BPR6ES | 7822 | 2 | LPG 2 | 1497 |
| Galant | 2.0 | | 97 - 03 | 4G63 | 4 | 1,1 | BKR6E-11 | 2756 | 14 | LPG 1 | 1496 |
| Galant | 2.0 | | 88 - 93 | 4G63 GTi16 | 4 | 0,8 | BPR7ES | 2023 | 19 | BPR7EIX | 4055 |
| Galant | 2.0 | | 82 - 87 | 4G63 TURBO | 4 | 0,8 | BR7ES | 5122 | | BR8EIX | 5044 |
| Galant GDI | 2.4 | 110 | 10.98 - | 4G64 GDI | 6 | 0,6 | IZFR5B | 4080 | | IZFR5B | 4080 |
| Galant / Sigma | | | 80 - | 4D55 | 4 | █ | Y-115T1 | 2189 | | | |
| Galant / Sigma QGS Typ | | | 80 - | 4D55 / T | 4 | █ | Y-115R1 | 2161 | | | |
| Galant 1200 | 1.2 | | - 84 | | 4 | 0,8 | BPR6ES | 7822 | 2 | LPG 2 | 1497 |
| Galant 1400 | 1.4 | | - 84 | | 4 | 0,9 | BPR5ES | 7422 | 6 | LPG 2 | 1497 |
| Galant 1600 | 1.6 | | 85 - 87 | 4G32 | 4 | 0,8 | BPR6ES | 7822 | 2 | LPG 2 | 1497 |
| Galant 1800 | 1.8 | 85 | 93 - 94 | 4G93 MPI | 4 | 1,1 | BKR6E-11 | 2756 | 14 | LPG 1 | 1496 |
| Galant 1800 | 1.8 | | 88 - 90 | 4G37 Cat. | 4 | 0,8 | BPR6ES | 7822 | 2 | LPG 2 | 1497 |
| Galant 1800 | 1.8 | | 90 - 91 | 4G37 Cat. | 4 | 1,1 | BPR6ES-11 | 4824 | 13 | LPG 2 | 1497 |
| Galant 1800 | 1.8 | | 92 - 96 | 4G37 Cat. | 4 | 1,1 | BPR7ES-11 | 7226 | | BPR8EIX | 6684 |
| Galant 1800 | 1.8 | | 94 - 96 | 4G93 | 4 | 0,8 | BK6E | 3536 | | LPG 1 | 1496 |
| Galant 2000 | 2.0 | 100 | 96 - 03 | 4G63 | 4 | 1,1 | BKR6E-11 | 2756 | 14 | LPG 1 | 1496 |
| Galant 2000 | 2.0 | 101 | 94 - 03 | 4G63 MPI | 4 | 1,1 | BKR6E-11 | 2756 | 14 | LPG 1 | 1496 |
| Galant 2000 | 2.0 | | 92 - | Cat. | 4 | 1,1 | BPR7ES-11 | 7226 | | BPR8EIX | 6684 |
| Galant 2000 | 2.0 | | 92 - 92 | 4G63 | 4 | 1,1 | BPR7ES-11 | 7226 | | BPR8EIX | 6684 |
| Galant 2000 | 2.0 | | 93 - 96 | 4G63 | 4 | 0,8 | BK6E | 3536 | | LPG 1 | 1496 |
| Galant 2000 | 2.0 | | | 4G63 Cat. | 4 | 1,1 | BPR6ES-11 | 4824 | 13 | LPG 2 | 1497 |
| Galant 2000 | 2.0 | | 92 - 92 | 4G63D | 4 | 0,8 | BPR6ES | 7822 | 2 | LPG 2 | 1497 |
| Galant 2000 V6 (E74A, E84A) | 2.0 | 110 | 05.92 - 10.94 | 6A12 MPI 24V | 6 | 1,1 | PFR6J-11 | 2743 | | PFR6J | 2645 |



ℓ kW



Cyl.

Order-
No. No.LPG/CNG
D-PowerOrder-
No.**MITSUBISHI**

| | | | | | | | | | | | |
|------------------------------|-----|-----|-------------|------------------|---|-----|------------|------|----|------------|------|
| Galant 2400 | 2.4 | | 94 - | 4G64 MPI DOHC | 6 | 1,1 | BPR6ES-11 | 4824 | 13 | LPG 2 | 1497 |
| Galant 2400 | 2.4 | | 94 - | 4G64 MPI SOHC | 6 | 1,1 | BKR6E-11 | 2756 | 14 | LPG 1 | 1496 |
| Galant 2500 (EC5A) | 2.5 | | 08.96 - 03 | 6A13 | 4 | 0,8 | PFR6J | 2645 | | PFR6J | 2645 |
| Galant 2500 V6 | 2.5 | 125 | 93-03.97 | 6G12 24V | 6 | 1,1 | PFR6J-11 | 2743 | | PFR6J | 2645 |
| Galant Station Wagon QGS Typ | | | 83 - | 4D55 | 4 | █ | Y-115R1 | 2161 | | | |
| Galant TD (E5..8) | 2.0 | 66 | 11.92-10.96 | 4D68 SOHC | 4 | █ | CY57 | 4994 | | D-POWER 21 | 4994 |
| Galant TD (EA) | 2.0 | 66 | 10.96-02.00 | 4D68 | 4 | █ | CY57 | 4994 | | D-POWER 21 | 4994 |
| Galant V6 | 2.5 | | 03.97 - 03 | 6A13 | 6 | 1,1 | PFR6G-11 | 5555 | | PFR7G | 4364 |
| Galant V6 24V | 2.5 | | 95 - 00 | 6G73 MPI | 6 | 1,1 | PFR6J-11 | 2743 | | PFR6J | 2645 |
| Galant Wagon TD (EA) | 2.0 | 66 | 10.96-02.00 | 4D68 | 4 | █ | CY57 | 4994 | | D-POWER 21 | 4994 |
| Galloper | 3.0 | 104 | 98-12.01 | G6AT | 6 | 1,1 | BPR5ES-11 | 4424 | | LPG 2 | 1497 |
| Galloper Td | 2.5 | 65 | 02.99 - 01 | D4BH | 4 | █ | CY57 | 4994 | | D-POWER 21 | 4994 |
| Galloper Td | 2.5 | 73 | 02.99 - 01 | D4BH | 4 | █ | CY57 | 4994 | | D-POWER 21 | 4994 |
| Grandis | 2.4 | 121 | 04.04 - | 4G69 | 4 | | LZFR6AI | 3656 | | LZFR6AI | 3656 |
| Grandis DI-D | 2.0 | 100 | 04.04 - | BSY (VW engine) | 4 | █ | YE14 | 7768 | | D-POWER 48 | 7768 |
| L200 | 1.6 | | 92 - | 4G32 | 4 | 0,9 | BPR5ES | 7422 | 6 | LPG 2 | 1497 |
| L200 | 1.6 | | | 4G32 Cat. | 4 | 0,8 | BPR6ES | 7822 | 2 | LPG 2 | 1497 |
| L200 | 2.0 | | - 92 | 4G63 | 4 | 0,8 | BPR7ES | 2023 | 19 | BPR8EIX | 6684 |
| L200 | 2.0 | | 92 - | 4G63 | 4 | 0,8 | BPR6ES | 7822 | 2 | LPG 2 | 1497 |
| L200 | 2.4 | 82 | 94 - | 4G64 MPI | 4 | 1,1 | BCPR6ES-11 | 7121 | 11 | LPG 3 | 1498 |
| L200 | 2.4 | 97 | 99 - | | 4 | 1,1 | BPR6ES-11 | 4824 | 13 | LPG 2 | 1497 |
| L200 | 2.5 | | - 93 | 4D55 | 4 | █ | Y-115T1 | 2189 | | | |
| L200 | 2.5 | | 99 - | 4D56 | 4 | █ | Y-733J | 6592 | | D-POWER 13 | 6592 |
| L200 | 2.6 | 76 | 93 - | 4G54/B | 4 | 1,1 | BPR6ES-11 | 4824 | 13 | LPG 2 | 1497 |
| L200 | 2.6 | | - 92 | 4G54 | 4 | 1,1 | BPR6ES-11 | 4824 | 13 | LPG 2 | 1497 |
| L200 | 2.6 | | 95 - | G54B | 4 | 1,1 | BUR6EA-11 | 5428 | | | |
| L200 (KOT-K3T) | 2.5 | 51 | 06.94-08.96 | 4D56 SOHC | 4 | █ | CY57 | 4994 | | D-POWER 21 | 4994 |
| L200 (KOT-K3T) | 2.5 | 51 | 11.93-05.94 | 4D56 without QGS | 4 | █ | Y-733J | 6592 | | D-POWER 13 | 6592 |
| ohne Schnellstartanlage | | | | | | | | | | | |
| L200 / 4WD | 2.3 | | 04.83-10.86 | 4D55 | 4 | █ | Y-115T1 | 2189 | | | |
| L300 | 1.4 | | 94 - | 4G33 | 4 | 0,7 | BP6ES | 7811 | 4 | LPG 2 | 1497 |
| L300 | 1.6 | 51 | 80 - 94 | 4G32 | 4 | 0,9 | BPR5ES | 7422 | 6 | LPG 2 | 1497 |
| L300 | 2.0 | 66 | 92 - | 4G63 Cat. | 4 | 0,8 | BPR6ES | 7822 | 2 | LPG 2 | 1497 |
| L300 | 2.0 | 85 | 07.94 - | 4G63 | 4 | 0,9 | BPR5ES | 7422 | 6 | LPG 2 | 1497 |
| L300 | 2.0 | | - 92 | 4G63 | 4 | 0,8 | BPR6ES | 7822 | 2 | LPG 2 | 1497 |
| L300 | 2.0 | | 95 - | 4G63 FBC | 4 | 1,1 | BKR5E-11 | 6953 | 33 | LPG 1 | 1496 |
| L300 | 2.0 | | 10.94 - | 4G63 MPI | 4 | 1,1 | BKR5E-11 | 6953 | 33 | LPG 1 | 1496 |
| L300 | 2.4 | 82 | 92 - | 4G64 Cat. | 4 | 1,1 | PGR6A-11 | 3738 | | PGR7A | 3200 |
| L300 | 2.5 | | - 92 | 4D5 | 4 | █ | Y-115T1 | 2189 | | | |
| L300 | 2.5 | | 97 - | 4D56 | 4 | █ | Y-733J | 6592 | | D-POWER 13 | 6592 |
| L300 / 4WD | 2.3 | | 04.83 - | 4D55 | 4 | █ | Y-115T1 | 2189 | | | |
| L300 / 4WD QGS Type | 2.3 | | | 4D55 | 4 | █ | Y-115R1 | 2161 | | | |
| L300 TD (P) | 2.5 | 64 | 06.93 - 96 | 4D56 SOHC | 4 | █ | CY57 | 4994 | | D-POWER 21 | 4994 |
| L400 | | | 95 - 97 | 4D56 | 4 | █ | CY57 | 4994 | | D-POWER 21 | 4994 |
| L400 | 2.0 | | 95 - | 4G63 MPI | 4 | 1,1 | BKR5E-11 | 6953 | 33 | LPG 1 | 1496 |
| L400 | 2.4 | | 95 - | 4G64 MPI | 4 | 1,1 | BKR5E-11 | 6953 | 33 | LPG 1 | 1496 |
| L400 | 2.5 | | 98 - | 4D56 | 4 | █ | Y-733J | 6592 | | D-POWER 13 | 6592 |
| L400 TD | 2.5 | 73 | 12.94 - | 4D56 | 4 | █ | CY57 | 4994 | | D-POWER 21 | 4994 |
| Lancer | 1.2 | | 01.84-07.84 | 4G16 | 4 | 0,9 | BPR5ES | 7422 | 6 | LPG 2 | 1497 |
| Lancer | 1.3 | 55 | 03.96 - 01 | 4G13 | 4 | 1,1 | BUR6EA-11 | 5428 | | | |
| Lancer | 1.3 | 60 | 09.03 - | | 4 | 1,1 | BKR6E-11 | 2756 | 14 | LPG 1 | 1496 |
| Lancer | 1.5 | | 01.84-07.84 | 4G15 | 4 | 0,9 | BPR5ES | 7422 | 6 | LPG 2 | 1497 |



ℓ kW



Cyl.

Order-
No.VLINE
No.LPG/CNG
D-PowerOrder-
No.**MITSUBISHI**

| | | | | | | | | | | | |
|------------------------------|-----|-----|--------------|------------------------|---|-----|-------------|-------|----|-------------|-------|
| Lancer | 1.6 | 72 | 09.03 - | 4G18 | 4 | 1,1 | BKR6E-11 | 2756 | 14 | LPG 1 | 1496 |
| Lancer | 1.6 | | 80 - 82 | 4G32 | 4 | 0,8 | BPR6ES | 7822 | 2 | LPG 2 | 1497 |
| Lancer | 1.8 | | 90 - 92 | 4G37 GLXi | 4 | 1,1 | BPR6ES-11 | 4824 | 13 | LPG 2 | 1497 |
| Lancer | 1.8 | | 90 - 92 | 4G37 GTi16 | 4 | 0,8 | BPR6ES | 7822 | 2 | LPG 2 | 1497 |
| Lancer | 1.8 | | 93 - | 4G93 GTi16 | 4 | 1,1 | BKR6E-11 | 2756 | 14 | LPG 1 | 1496 |
| Lancer | 2.0 | 99 | 09.03 - | 4G63 | 4 | 1,1 | IGR6A11 | 5743 | | IGR6A11 | 5743 |
| Lancer | 2.0 | | 81 - 82 | 4G63 TURBO | 4 | 0,8 | BR7ES | 5122 | | BR8EIX | 5044 |
| Lancer (CB/CD) | 2.0 | 50 | 12.93 -06.96 | 4D68 | 4 | █ | CY57 | 4994 | | D-POWER 21 | 4994 |
| Lancer 1200 | 1.2 | | - 84 | 4G11 | 4 | 0,9 | BPR5ES | 7422 | 6 | LPG 2 | 1497 |
| Lancer 1200 | 1.2 | | 08.84 - 89 | 4G16 | 4 | 0,8 | BPR6ES | 7822 | 2 | LPG 2 | 1497 |
| Lancer 1300 | 1.3 | 55 | 10.92 - 01 | 4G13 MPI | 4 | 1,1 | BPR5ES-11 | 4424 | | LPG 2 | 1497 |
| Lancer 1300 | 1.3 | | 97 - | 4G1 | 4 | 1,1 | BPR5ES-11 | 4424 | | LPG 2 | 1497 |
| Lancer 1300 | 1.3 | | 89 - 92 | 4G13 | 4 | 0,8 | BPR6ES | 7822 | 2 | LPG 2 | 1497 |
| Lancer 1300 | 1.3 | | 10.92 - 01 | 4G13 | 4 | 0,8 | BP5ES | 6511 | 8 | LPG 2 | 1497 |
| Lancer 1300 | 1.3 | | -09.92 | 4G13 Cat. | 4 | 0,8 | BPR6ES | 7822 | 2 | LPG 2 | 1497 |
| Lancer 1400 | 1.4 | 50 | 80 - 84 | 4G12 | 4 | 0,9 | BPR5ES | 7422 | 6 | LPG 2 | 1497 |
| Lancer 1500 | 1.5 | 69 | 93 - 00 | 4G15 | 4 | 0,8 | BP5ES | 6511 | 8 | LPG 2 | 1497 |
| Lancer 1500 | 1.5 | | 08.84 - 92 | 4G15 | 4 | 0,8 | BPR6ES | 7822 | 2 | LPG 2 | 1497 |
| Lancer 1500 | 1.5 | | 86 - 92 | 4G15 Cat. | 4 | 1,1 | BPR6ES-11 | 4824 | 13 | LPG 2 | 1497 |
| Lancer 1500 | 1.5 | | 94 - 96 | 4G91 MPI | 4 | 1,1 | BK6E-11 | 7340 | | LPG 1 | 1496 |
| Lancer 1600 | 1.6 | 83 | 10.92 - 00 | 4G92 MPI | 4 | 1,1 | BKR6E-11 | 2756 | 14 | LPG 1 | 1496 |
| Lancer 1600 | 1.6 | | - 84 | | 4 | 0,9 | BPR5ES | 7422 | 6 | LPG 2 | 1497 |
| Lancer 1600 | 1.6 | | 90 -09.92 | 4G61 DOHC | 4 | 0,8 | BPR6ES | 7822 | 2 | LPG 2 | 1497 |
| Lancer 1600 | 1.6 | | 97 - | 4G9 MVV | 4 | 1,1 | BKR5E-11 | 6953 | 33 | LPG 1 | 1496 |
| Lancer 1600 | 1.6 | | 97 - 00 | 4G9 (not MVV Magermix) | 4 | 1,1 | BKR6E-11 | 2756 | 14 | LPG 1 | 1496 |
| Lancer 1600 | 1.6 | | 94 -12.96 | 4G92 MVV | 4 | 1,1 | BKR5E-11 | 6953 | 33 | LPG 1 | 1496 |
| Lancer 1600 Turbo | 1.6 | | 85 - 85 | 4G32T | 4 | 0,8 | BPR7ES | 2023 | 19 | BPR8EIX | 6684 |
| Lancer 1600 Turbo | 1.6 | | 86 - 88 | 4G32T | 4 | 0,8 | BPR6ES | 7822 | 2 | LPG 2 | 1497 |
| Lancer 1600 Twin Carb. | 1.6 | | | | 4 | 0,8 | BPR6ES | 7822 | 2 | LPG 2 | 1497 |
| Lancer 1800 | 1.8 | | 86 - 92 | 4G37 Cat. | 4 | 1,1 | BPR6ES-11 | 4824 | 13 | LPG 2 | 1497 |
| Lancer 1800 | 1.8 | | 86 - 92 | 4G67 | 4 | 0,8 | BPR7ES | 2023 | 19 | BPR8EIX | 6684 |
| Lancer 1800 16V | 1.8 | | 93 - | 4G93 MPI | 4 | 0,8 | BK6E | 3536 | | LPG 1 | 1496 |
| Lancer 2000 | 2.0 | | 01.05 - | 4G94 | 4 | 1,1 | BKR5E-11 | 6953 | 33 | LPG 1 | 1496 |
| Lancer Evolution V (CP9A) | 2.0 | 206 | | 4G63 Turbo | 4 | | PGR7A | 3200 | | PGR7A | 3200 |
| Lancer Evolution VI (CP9A) | 2.0 | 206 | 02.98 -05.99 | 4G63 Turbo | 4 | | PGR7A | 3200 | | PGR7A | 3200 |
| Lancer Evolution VI Tommi | 2.0 | | 01.99 - | 4G63 Turbo | 4 | | IGR7A | 6687 | | IGR7A | 6687 |
| Makinen Edit.(CP9A) | | | | | | | | | | | |
| Lancer Evolution VII (CT9A) | 2.0 | 206 | 01 - | 4G63 Turbo | 4 | | IGR7A-G | 3106 | | IGR7A-G | 3106 |
| Lancer Evolution VIII (CT9A) | 2.0 | 195 | 04 - | 4G63 Turbo | 4 | | IGR7A-G | 3106 | | IGR7A-G | 3106 |
| Lancer Evolution IX (CT9A) | 2.0 | 206 | 03.05 - 07 | 4G63-D4 Turbo (WT)DOHC | 4 | | ILFR7H | 5245 | | ILFR7H | 5245 |
| Lancer Evolution X | 2.0 | 217 | 04.08 - | 4B11 FQ30 | 4 | | DILKR8B6 | 91448 | | DILKR8B6 | 91448 |
| Lancer Sportback 1.5 (CX2A) | 1.5 | 80 | 06.08 - | 4A91 MIVEC | 4 | 1,1 | ILZFR6C-11K | 4673 | | ILZFR6C-11K | 4673 |
| Lancer Sportback 1.8 (CX3A) | 1.8 | 105 | 06.08 - | 4B10 MIVEC | 4 | 0,8 | FR6EI | 2687 | | | |
| Lancer Stufenheck 1.5 (CY2A) | 1.5 | 80 | 06.08 - | 4A91 MIVEC | 4 | 1,1 | ILZFR6C-11K | 4673 | | ILZFR6C-11K | 4673 |
| Lancer Stufenheck 1.8 (CY3A) | 1.8 | 105 | 02.08 - | 4B10 MIVEC | 4 | 0,8 | FR6EI | 2687 | | FR6EI | 2687 |
| Laser 1800 | 1.8 | | | 4G37 | 4 | 1,1 | BPR6ES-11 | 4824 | 13 | LPG 2 | 1497 |
| Laser 2000 | 2.0 | | | 4G63 | 4 | 1,1 | BPR6ES-11 | 4824 | 13 | LPG 2 | 1497 |
| Laser 2000 Turbo | 2.0 | | | 4G63 | 4 | 0,8 | BPR6ES | 7822 | 2 | LPG 2 | 1497 |
| Legnum 2500 (EC5A) | 2.5 | | 08.96 - | 6A13 | 4 | 0,8 | PFR6J | 2645 | | PFR6J | 2645 |
| Mirage | 1.4 | | 82 - 83 | 4G12 TURBO | 4 | 0,8 | BPR6ES | 7822 | 2 | LPG 2 | 1497 |
| Mirage | 1.5 | | 94 - | 4G15 MPI | 4 | 1,1 | BPR5ES-11 | 4424 | | LPG 2 | 1497 |
| Mirage | 1.6 | | 96 - | 4G92 | 4 | 1,1 | BKR6E-11 | 2756 | 14 | LPG 1 | 1496 |



ℓ kW



Cyl.

Order-
No. No.LPG/CNG
D-PowerOrder-
No.**MITSUBISHI**

| | | | | | | | | | | | |
|----------------------------|-----|-----|---------------|-------------------------|---|-----|-----------|------|----|------------|------|
| Mirage | 1.8 | | 94 - | 4G93 MPI | 4 | 1,1 | BKR5E-11 | 6953 | 33 | LPG 1 | 1496 |
| Montero | | | 83 - | 4D55 | 4 | ☑ | Y-115T1 | 2189 | | | |
| Montero | | | 83 - | 4D55 QGS Type | 4 | ☑ | Y-115R1 | 2161 | | | |
| Montero | | | 85 - | 4D55T | | | only OES | | | | |
| Montero | | | 92 - 93 | 4D56 | 4 | ☑ | Y-115T1 | 2189 | | | |
| Montero | | | 94 - 95 | 4D56 | 4 | ☑ | CY57 | 4994 | | D-POWER 21 | 4994 |
| Montero | | | 96 - | 4D56 | 4 | ☑ | Y-733J | 6592 | | D-POWER 13 | 6592 |
| Montero Sport | | | 97 - | | 4 | ☑ | Y-733J | 6592 | | D-POWER 13 | 6592 |
| Montero V6 3000 | 3.0 | | 91 - | 6G72 | 6 | 1,1 | BPR5ES-11 | 4424 | | LPG 2 | 1497 |
| Multicar M25 | | 40 | 01.91 - | VW028B-1Y | 4 | ☑ | Y-918J | 6285 | | D-POWER 2 | 6285 |
| Multicar M26 | | 40 | 01.91 - | VW028B-1Y | 4 | ☑ | Y-918J | 6285 | | D-POWER 2 | 6285 |
| Outlander | 2.0 | 93 | 05.03 - | | 4 | 1,1 | IGR6A11 | 5743 | | IGR6A11 | 5743 |
| Outlander | 2.0 | 100 | 05.03 - | 4G63 | 4 | 1,1 | IGR6A11 | 5743 | | IGR6A11 | 5743 |
| Outlander | 2.0 | 177 | 05.03 - | | 4 | 1,1 | IGR6A11 | 5743 | | IGR6A11 | 5743 |
| Outlander | 2.4 | 102 | 05.03 - | | 4 | | LZFR6AI | 3656 | | LZFR6AI | 3656 |
| Outlander | 2.4 | 118 | 05.03 - | 4G69 | 4 | | LZFR6AI | 3656 | | LZFR6AI | 3656 |
| Outlander | 2.4 | 125 | 08 - | 4B12 | 4 | 0,8 | FR6EI | 2687 | | | |
| Outlander 2.0 DI-D | 2.0 | 103 | 06 - | BSY | 4 | ☑ | CZ304 | 9864 | | D-POWER 55 | 9864 |
| Outlander 2.0 Turbo | 2.0 | 148 | 05 - | 4G63 Turbo Mpi | 4 | 1,1 | IGR6A11 | 5743 | | IGR6A11 | 5743 |
| Pajero | | | 85 - | 4D55T | 4 | | only OES | | | | |
| Pajero | | | 92 - 93 | 4D56 | 4 | ☑ | Y-115T1 | 2189 | | | |
| Pajero | | | | 4D56 S-QGS Type | 4 | | only OES | | | | |
| Pajero | 2.3 | 62 | 83 - 84 | 4D55 | 4 | ☑ | Y-115T1 | 2189 | | | |
| Pajero | 2.4 | | 97 - | 4G64 | 4 | 1,1 | BPR6ES-11 | 4824 | 13 | LPG 2 | 1497 |
| Pajero | 3.0 | 130 | 97 - | 6G72 24Ventiler | 6 | 1,1 | PFR6J-11 | 2743 | | PFR6J | 2645 |
| Pajero | 3.0 | | 97 - | 6G72 12Ventiler | 6 | 1,1 | BPR5ES-11 | 4424 | | LPG 2 | 1497 |
| Pajero | 3.5 | 143 | 97 - | 6G74 | 6 | 1,1 | PFR5J-11 | 4642 | | PFR5J-11 | 4642 |
| Pajero GDI V60 | 3.5 | 149 | 04.00 - | V6 | 6 | 0,6 | IZFR5B | 4080 | | IZFR5B | 4080 |
| Pajero (V4..) | 2.8 | 92 | 06.94 - 04.00 | 4M40 | 4 | ☑ | CY55 | 3861 | | | |
| Pajero / Montero QGS Type | | | 83 - 84 | 4D55 | | ☑ | Y-115R1 | 2161 | | | |
| Pajero 2400 | 2.4 | | 03.91 - | 4G64 | 4 | 1,1 | BPR6ES-11 | 4824 | 13 | LPG 2 | 1497 |
| Pajero 2600 | 2.6 | | 92 - | | 4 | 1,1 | BP6ES-11 | 1212 | | | |
| Pajero 2600 | 2.6 | | | 4G54 | 4 | 0,9 | BPR5ES | 7422 | 6 | LPG 2 | 1497 |
| Pajero 2600 | 2.6 | | | 4G54 Cat. | 4 | 1,1 | BPR5ES-11 | 4424 | | LPG 2 | 1497 |
| Pajero 3.2 DI-D | 3.2 | 118 | 04.00 - | | 4 | ☑ | Y-532J | 7782 | | | |
| Pajero 3.8 V6 | 3.8 | 184 | 02.07 - | engine Eclipse USA | 6 | | IFR6B-K | 4867 | | IFR6B-K | 4867 |
| Pajero 3000 V6 | 3.0 | | 89 - | 6G72 | 6 | 1,1 | BPR5ES-11 | 4424 | | LPG 2 | 1497 |
| Pajero 3500 V6 | 3.5 | 153 | 04.94 - 97 | 6G74 DOHC | 6 | 1,1 | PFR6J-11 | 2743 | | PFR6J | 2645 |
| Pajero Classic | 3.2 | 118 | 05.05 - | 4M41 | | ☑ | Y1007J | 3040 | | D-POWER 59 | 3040 |
| Pajero III | 3.2 | 118 | 10.01 - | 4M41 | | ☑ | Y1007J | 3040 | | D-POWER 59 | 3040 |
| Pajero III | 3.2 | 121 | 04.00 - 10.01 | 4M41 | | ☑ | Y1007J | 3040 | | D-POWER 59 | 3040 |
| Pajero Pinin (H66W,H67W) | 1.8 | 88 | 00 - | 4G93 GDI | 4 | 0,6 | IZFR6B | 3116 | | IZFR6B | 3116 |
| Pajero Pinin (H76W,H77W) | 2.0 | 95 | 09.00 - | 4G94 GDI | 4 | 0,6 | IZFR5B | 4080 | | IZFR5B | 4080 |
| Pajero Sport | | | 97 - | 4D56-QGS | 4 | | only OES | | | | |
| Pajero Sport | 3.0 | | 99 - | 6G72 24Ventiler | 6 | 1,1 | PFR6J-11 | 2743 | | PFR6J | 2645 |
| Pajero TD Intercooler (IV) | 2.5 | 62 | 08.93 - 05.99 | 4D56 T | 4 | ☑ | Y-733J | 6592 | | D-POWER 13 | 6592 |
| Pajero TD Intercooler (V) | 2.5 | 73 | 11.93 - 01.98 | 4D56 T | 4 | ☑ | CY57 | 4994 | | D-POWER 21 | 4994 |
| Pajero TD not QGS Type | 2.5 | 62 | 06.86 - | 4D56 Turbo not QGS Type | | ☑ | Y-115T1 | 2189 | | | |
| Santamo | 2.0 | 102 | 99 - | DOHC / SOHC | 4 | 1,1 | BP6ES-11 | 1212 | | | |
| Sapporo | 2.0 | | 82 - 84 | 4G63 TURBO | 4 | 0,8 | BPR7ES | 2023 | 19 | BPR7EIX | 4055 |
| Sapporo 1200 | 1.2 | | -07.80 | | 4 | 0,8 | BPR6ES | 7822 | 2 | LPG 2 | 1497 |
| Sapporo 1400 | 1.4 | | -07.80 | | 4 | 0,9 | BPR5ES | 7422 | 6 | LPG 2 | 1497 |



ℓ kW



Cyl.

Order-
No.VLINE
No.LPG/CNG
D-PowerOrder-
No.**MITSUBISHI**

| | | | | | | | | | | | |
|-----------------------------|-----|-----|---------------|-------------------|---|-----|-----------|------|----|------------|------|
| Sapporo 1600 | 1.6 | | -07.80 | | 4 | 0,9 | BPR5ES | 7422 | 6 | LPG 2 | 1497 |
| Sapporo 1600 Twin Carb. | 1.6 | | -07.80 | | 4 | 0,8 | BPR6ES | 7822 | 2 | LPG 2 | 1497 |
| Sapporo 2000 | 2.0 | | 81 - 84 | 4G63 | 4 | 0,8 | BPR6ES | 7822 | 2 | LPG 2 | 1497 |
| Sapporo 2400 | 2.4 | | -07.80 | 4G64 | 4 | 1,1 | BPR7ES-11 | 7226 | | BPR8EIX | 6684 |
| Sapporo GSR | 2.0 | | 03.81 - 11.84 | | 4 | 0,8 | BPR7ES | 2023 | 19 | BPR8EIX | 6684 |
| Sapporo Turbo | 2.0 | | 03.81 - 11.84 | | 4 | 0,8 | BR7ES | 5122 | | BR8EIX | 5044 |
| Shogun | 2.3 | | 01.84 - 09.86 | 4D55 | 4 | █ | Y-115R1 | 2161 | | | |
| Shogun | 2.3 | | 01.84 - 09.86 | 4D55 | 4 | █ | Y-115T1 | 2189 | | | |
| Shogun | 2.5 | | 85 - 12.90 | 4D56 | 4 | █ | Y-115T1 | 2189 | | | |
| Shogun | 2.5 | | 94 - 95 | 4D56 | 4 | █ | CY57 | 4994 | | D-POWER 21 | 4994 |
| Shogun | 2.5 | | 01.96 - 03.00 | 4D56 | 4 | █ | Y-733J | 6592 | | D-POWER 13 | 6592 |
| Shogun | 2.6 | | 83 - 90 | 4G54 | 4 | 0,9 | BPR5ES | 7422 | 6 | LPG 2 | 1497 |
| Shogun | 2.6 | | 83 - 90 | 4G54 | 4 | 0,9 | BPR5ES | 7422 | 6 | LPG 2 | 1497 |
| Shogun | 3.0 | | 83 - 90 | 6G72 | 6 | 1,1 | BPR5ES-11 | 4424 | | LPG 2 | 1497 |
| Shogun | 3.0 | | 91 - 94 | 6G72 | 6 | 1,1 | BPR5ES-11 | 4424 | | LPG 2 | 1497 |
| Shogun | 3.0 | | 91 - 94 | 6G72 | 6 | 1,1 | BPR5ES-11 | 4424 | | LPG 2 | 1497 |
| Shogun | 3.0 | | 94 - | 6G72 | 6 | 1,1 | PFR6J-11 | 2743 | | | |
| Shogun | 3.5 | | 00 - | | 6 | 0,8 | IZFR5B | 4080 | | | |
| Shogun | 3.5 | | 91 - | 6G74 | 6 | 1,1 | PFR5J-11 | 4642 | | | |
| Shogun PININ | 1.8 | | 00 - | 4G93 GDI | 4 | 0,8 | IZFR6B | 3116 | | | |
| Shogun PININ | 2.0 | | 00 - | 4G94 GDI | 4 | 0,8 | IZFR5B | 4080 | | | |
| Sigma | | | 80 - | 4D55 | | █ | Y-115T1 | 2189 | | | |
| Sigma | | | 80 - | 4D55 / T QGS Type | | █ | Y-115R1 | 2161 | | | |
| Sigma V6 | 3.0 | | 91 - 93 | 6G72 DOHC 24V | 6 | 1,1 | PFR6J-11 | 2743 | | PFR6J | 2645 |
| Sigma V6 | 3.0 | | 91 - 93 | 6G72 SOHC | 6 | 1,1 | BPR6ES-11 | 4824 | 13 | LPG 2 | 1497 |
| Sigma 3000 | 3.0 | | 93 - 96 | 6G72 MPI V6 | 6 | 1,1 | BPR6ES-11 | 4824 | 13 | LPG 2 | 1497 |
| Sigma 3000 | 3.0 | | 94 - 96 | 6G72 MPI V6-24V | 6 | 1,1 | PFR6J-11 | 2743 | | PFR6J | 2645 |
| Space Gear | 2.0 | 83 | 04.95 - 01 | 4G63 MPI | 4 | 1,1 | BKR5E-11 | 6953 | 33 | LPG 1 | 1496 |
| Space Gear | 2.0 | | 97 - 01 | 4G69 | 4 | 1,1 | BKR5E-11 | 6953 | 33 | LPG 1 | 1496 |
| Space Gear | 2.4 | 97 | 04.95 - 01 | 4G64 MPI | 4 | 1,1 | BKR5E-11 | 6953 | 33 | LPG 1 | 1496 |
| Space Gear | 2.5 | 73 | 12.94 - | 4D56 | 4 | █ | CY57 | 4994 | | D-POWER 21 | 4994 |
| Space Gear | 2.5 | 73 | 06.94 - 05.95 | 4D56 Turbo | 4 | █ | Y-733J | 6592 | | D-POWER 13 | 6592 |
| Space Gear | 2.5 | | 98 - | 4D56 Turbo | 4 | █ | Y-733J | 6592 | | D-POWER 13 | 6592 |
| Space Runner | 1.8 | | 97 - 99 | 4G93 | 4 | 1,1 | BKR6E-11 | 2756 | 14 | LPG 1 | 1496 |
| Space Runner | 2.0 | 60 | 06.93 - | 4D68 | 4 | █ | CY57 | 4994 | | D-POWER 21 | 4994 |
| Space Runner | 2.0 | 100 | 99 - 08.02 | 4G63 MPI | 4 | 1,1 | BKR6E-11 | 2756 | 14 | LPG 1 | 1496 |
| Space Runner 1800 | 1.8 | 90 | 09.91 - 92 | 4G93 | 4 | 1,1 | BKR6E-11 | 2756 | 14 | LPG 1 | 1496 |
| Space Runner 1800 | 1.8 | 90 | 91 - 99 | 4G93 MPI | 4 | 1,1 | BKR6E-11 | 2756 | 14 | LPG 1 | 1496 |
| Space Runner 1800 | 1.8 | | 94 - 99 | 4G93 | 4 | 0,8 | BK6E | 3536 | | LPG 1 | 1496 |
| Space Runner GDI | 2.4 | 110 | 99 - | 4G64 GDI | 4 | 0,6 | IZFR5B | 4080 | | IZFR5B | 4080 |
| Space Star | 1.6 | | 99 - | 4G92 | 4 | 1,1 | BKR5E-11 | 6953 | 33 | LPG 1 | 1496 |
| Space Star | 1.9 | 59 | | F9QT | 4 | █ | Y-732J | 5605 | | D-POWER 4 | 5605 |
| Space Star 1.9 DI-D | 1.9 | 75 | 12.00 - | DCI Renault | 4 | █ | Y-732J | 5605 | | D-POWER 4 | 5605 |
| Space Star 1300 | 1.3 | 63 | 12.98 - | 4G13 | 4 | 1,1 | BKR5E-11 | 6953 | 33 | LPG 1 | 1496 |
| Space Star 1600 | 1.6 | 72 | 12.98 - | 4G16 | 4 | 1,1 | BKR5E-11 | 6953 | 33 | LPG 1 | 1496 |
| Space Star 1800 GDI | 1.8 | 87 | 03.99 - | 4G93 | 4 | 0,6 | IZFR6B | 3116 | | IZFR6B | 3116 |
| Space Star GDI | 1.8 | 92 | 99 - | 4G93 GDI | 4 | 0,6 | IZFR6B | 3116 | | IZFR6B | 3116 |
| Space Wagon | | | 85 - 85 | | 4 | 0,8 | BPR7ES | 2023 | 19 | BPR8EIX | 6684 |
| Space Wagon | | | 86 - 88 | | 4 | 0,8 | BPR6ES | 7822 | 2 | LPG 2 | 1497 |
| Space Wagon | 2.0 | | 97 - | 4G63 | 4 | 1,1 | BKR5E-11 | 6953 | 33 | LPG 1 | 1496 |
| Space Wagon (N) | 2.0 | 60 | 06.93 - 11.00 | 4D68 | 4 | █ | CY57 | 4994 | | D-POWER 21 | 4994 |
| Space Wagon GDI (N84W,N94W) | 2.4 | 110 | 10.98 - 07.00 | 4G64 GDI | 4 | 0,6 | IZFR5B | 4080 | | IZFR5B | 4080 |



ℓ kW

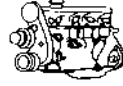

Cyl.

Order-
No. No.LPG/CNG
D-PowerOrder-
No.**MITSUBISHI**

| | | | | | | | | | | | | |
|-----------------------|-----|-----|---------------|---------------|---|-----|------------|------|----|---------|------|--|
| Space Wagon Gdi (N5.) | 2.0 | 98 | 02.02 - | 4G94 | 4 | 1,1 | HB6BIX-11P | 5705 | | | | |
| Space Wagon 1800 | 1.8 | | 84 - 91 | 4G37 | 4 | 0,8 | BPR6ES | 7822 | 2 | LPG 2 | 1497 | |
| Space Wagon 1800 | 1.8 | | 94 - | 4G93 | 4 | 0,8 | BK6E | 3536 | | LPG 1 | 1496 | |
| Space Wagon 1800 | 1.8 | | 09.91 - 93 | 4G93 | 4 | 1,1 | BKR6E-11 | 2756 | 14 | LPG 1 | 1496 | |
| Space Wagon 1800 | 1.8 | | 94 - | 4G93 MPI | 4 | 1,1 | BKR6E-11 | 2756 | 14 | LPG 1 | 1496 | |
| Space Wagon 2000 | 2.0 | 98 | 92 - 00 | 4G63 MPI Cat. | 4 | 1,1 | BKR6E-11 | 2756 | 14 | LPG 1 | 1496 | |
| Space Wagon 2000 | 2.0 | | 89 - 91 | 4G63 Cat. | 4 | 1,1 | BPR7ES-11 | 7226 | | BPR8EIX | 6684 | |
| Space Wagon 2000 4WD | 2.0 | | 89 - | | 4 | 0,8 | BPR7ES | 2023 | 19 | BPR8EIX | 6684 | |
| Space Wagon 2400 | 2.4 | | 93 - 95 | 4G64 Cat. | 4 | 1,1 | BKR6E-11 | 2756 | 14 | LPG 1 | 1496 | |
| Starion 2000 | 2.0 | | | | 4 | 0,8 | BPR7ES | 2023 | 19 | BPR8EIX | 6684 | |
| Starion 2600 Turbo | 2.6 | | 89 - | 4G54 Cat. | | 1,1 | BPR6ES-11 | 4824 | 13 | LPG 2 | 1497 | |
| Starion Turbo | 2.0 | | 82 - 88 | 4G63 | 4 | 0,8 | BR7ES | 5122 | | BR8EIX | 5044 | |
| Tredia | 1.4 | | 82 - 84 | 4G12 | 4 | 0,9 | BPR5ES | 7422 | 6 | LPG 2 | 1497 | |
| Tredia | 1.6 | | 85 - 85 | | 4 | 0,8 | BPR6ES | 7822 | 2 | LPG 2 | 1497 | |
| Tredia | 1.6 | | 86 - | | 4 | 0,9 | BPR5ES | 7422 | 6 | LPG 2 | 1497 | |
| Tredia | 1.6 | | 82 - 84 | 4G32 | 4 | 0,9 | BPR5ES | 7422 | 6 | LPG 2 | 1497 | |
| Tredia Turbo | 1.6 | | 82 - 84 | 4G32 TURBO | 4 | 0,8 | BPR6ES | 7822 | 2 | LPG 2 | 1497 | |
| Tredia Turbo | 1.8 | 100 | 01.85 - 07.86 | 4G37T | 4 | 0,8 | BR7ES | 5122 | | BR8EIX | 5044 | |
| Truck / 4WD | | | 83 - | 4D55T | | | Y-115R1 | 2161 | | | | |

MORGAN

| | | | | | | | | | | | | |
|--------|-----|-----|---------------|---------------|---|-----|-----------|------|----|-------|------|--|
| 4/4 | 1.6 | 71 | 01.82 - 93 | CVH Ford | 4 | 0,8 | BCPR6ES | 2330 | 12 | LPG 3 | 1498 | |
| 4/4 | 1.6 | 72 | 01.82 - | 132D.000 | 4 | 0,7 | BP6ES | 7811 | 4 | LPG 2 | 1497 | |
| 4/4 | 1.6 | | 82 - 83 | FIAT | 4 | 0,8 | BPR6ES | 7822 | 2 | LPG 2 | 1497 | |
| 4/4 | 1.8 | 89 | 02.93 - | Zetec 16V | 4 | 1,3 | PTR5A-13 | 2467 | 25 | LPG 4 | 1511 | |
| 4/4 | 1.8 | | 94 - 98 | FORD ZETEC | 4 | 1,0 | PTR5A-10 | 5055 | | | | |
| Aero 8 | 4.4 | 210 | 00 - | BMW M62B44 | 8 | | BKR6EQUIP | 3199 | 30 | LPG 1 | 1496 | |
| Plus 4 | 2.0 | 90 | 01.85 - 86 | 132C3.000 | 4 | 0,7 | BP6ES | 7811 | 4 | LPG 2 | 1497 | |
| Plus 4 | 2.0 | 98 | 09.87 - 92 | M16i | 4 | 0,8 | BCPR6ES | 2330 | 12 | LPG 3 | 1498 | |
| Plus 4 | 2.0 | 99 | 09.92 - 96 | T16 | 4 | 0,8 | BCPR6ES | 2330 | 12 | LPG 3 | 1498 | |
| Plus 8 | 3.5 | 136 | 01.90 - 01 | V8 Rover Cat. | 8 | 0,7 | BP6ES | 7811 | 4 | LPG 2 | 1497 | |
| Plus 8 | 3.5 | 142 | 01.90 - 01 | V8 Rover | 8 | 0,7 | BP6ES | 7811 | 4 | LPG 2 | 1497 | |
| Plus 8 | 3.9 | 140 | 01.90 - 09.03 | V8 Kat Rover | 8 | 0,8 | BPR6ES | 7822 | 2 | LPG 2 | 1497 | |
| Plus 8 | 4.0 | | 01 - | ROVER V8 | 8 | 1,1 | PFR6N-11 | 3546 | | LPG 1 | 1496 | |
| Plus 8 | 4.6 | | 97 - 99 | ROVER V8 | 8 | 1,1 | PFR6N-11 | 3546 | | LPG 1 | 1496 | |

NISSAN

| | | | | | | | | | | | | |
|--------------------|-----|-----|---------------|---------------|---|-----|------------|------|----|----------|------|--|
| 100 NX B13 | 1.6 | 66 | 10.90 - 95 | GA16DE Cat. | 4 | 0,9 | BKR6E | 6962 | 28 | LPG 1 | 1496 | |
| 100 NX B13 | 1.6 | 66 | 10.90 - 93 | GA16DS Cat. | 4 | 0,9 | BKR6E | 6962 | 28 | LPG 1 | 1496 | |
| 100 NX B13 | 1.6 | 75 | 09.93 - 94 | GA16DE | 4 | 0,8 | BKR5E | 7938 | 35 | LPG 1 | 1496 | |
| 100 NX B13 | 2.0 | 105 | 10.90 - 95 | SR20DE Cat. | 4 | 0,9 | BKR6EY | 3696 | | LPG 1 | 1496 | |
| 200 SX Turbo S13 | 1.8 | 124 | 89 - 93 | CA18DET | 4 | 1,1 | PFR6A-11 | 4045 | | PFR6A-11 | 4045 | |
| 200 SX Turbo S14 | 2.0 | 147 | 08.94 - 12.99 | SR20DET | 4 | 0,9 | PFR6B-9 | 3100 | | PFR7B | 4853 | |
| 200 SX Turbo S30 | 1.8 | 124 | 09.88 - 93 | CA18DET Cat. | 4 | 1,1 | PFR6A-11 | 4045 | | PFR6A-11 | 4045 | |
| 200 SX Turbo 30 | 1.8 | 129 | 09.88 - 93 | CA18DET | 4 | 1,1 | BCPR6ES-11 | 7121 | 11 | LPG 3 | 1498 | |
| 280 ZX Turbo | 2.8 | 147 | - 82 | L28ET | 6 | 1,1 | BPR6ES-11 | 4824 | 13 | LPG 2 | 1497 | |
| 280 ZX Turbo S130 | 2.8 | 147 | 09.82 - 84 | L28ET | 6 | 1,1 | BPR6ES-11 | 4824 | 13 | LPG 2 | 1497 | |
| 300 ZX Z31 | 3.0 | 122 | 01.84 - 89 | VG30 | 6 | 1,1 | BCPR6ES-11 | 7121 | 11 | LPG 3 | 1498 | |
| 300 ZX Z32 | 3.0 | | 90 - 96 | VG30DE | 6 | 1,1 | PFR6B-11 | 4014 | | PFR7B | 4853 | |
| 300 ZX Biturbo Z32 | 3.0 | 206 | 01.90 - 95 | VG30DETT Cat. | 6 | 1,1 | PFR6B-11C | 2684 | | | | |
| 300 ZX Turbo Z31 | 3.0 | 169 | 01.84 - 87 | VG30T | 6 | 1,1 | BCPR6E-11 | 3132 | 11 | LPG 3 | 1498 | |
| 300 ZXT Turbo Z31 | 3.0 | 149 | 02.87 - 90 | VG30ET Cat. | 6 | 1,1 | BCPR6E-11 | 3132 | 11 | LPG 3 | 1498 | |



ℓ kW



Cyl.

Order-
No.VLINE
No.LPG/CNG
D-PowerOrder-
No.**NISSAN**

| | | | | | | | | | | | | |
|----------------------------|-----|-----|---------------|-----------------------|---|-----|--------------|-------|----|------------------|-------|--|
| 300 ZXTT Biturbo Z32 | 3.0 | 197 | 90 - 95 | VG30DETT | 6 | 1,1 | PFR6B-11C | 2684 | | | | |
| 350 Z | 3.5 | 206 | 09.03 - | VQ35DE | 6 | 1,1 | PLFR5A-11 | 6240 | | LPG 7 | 1640 | |
| 350 Z | 3.5 | 221 | 06 - | VQ35DE | 6 | 1,1 | PLFR5A-11 | 6240 | | LPG 7 | 1640 | |
| 350 Z Roadster | 3.5 | 206 | 02.05 - | VQ35DE | 6 | 1,1 | PLFR5A-11 | 6240 | | LPG 7 | 1640 | |
| 350 Z Roadster | 3.5 | 221 | 06 - | VQ35DE | 6 | 1,1 | PLFR5A-11 | 6240 | | LPG 7 | 1640 | |
| Almera N15 | 1.4 | 55 | 09.95 - 04.00 | GA14DE | 4 | 0,8 | BKR5E | 7938 | 35 | LPG 1 | 1496 | |
| Almera N15 | 1.6 | 66 | 09.95 - | GA16DE | 4 | 0,8 | BKR5E | 7938 | 35 | LPG 1 | 1496 | |
| Almera N15 | 1.6 | 66 | 95 - 00 | QG15DE | 4 | 1,1 | BKR5E-11 | 6953 | 33 | LPG 1 | 1496 | |
| Almera N16 | 1.5 | 66 | 02.00 - 09.02 | QG15DE | 4 | 1,1 | BKR5E-11 | 6953 | 33 | LPG 1 | 1496 | |
| Almera N16 | 1.5 | 72 | 10.02 - | QG15DE | 4 | 1,1 | LFR5A-11 | 6376 | | LPG 7 | 1640 | |
| Almera N16 | 1.8 | 84 | 02.00 - 09.02 | QG18DE | 4 | 1,1 | BKR5E-11 | 6953 | 33 | LPG 1 | 1496 | |
| Almera N16 | 1.8 | 85 | 10.02 - | QG18DE | 4 | 1,1 | LFR5A-11 | 6376 | | LPG 7 | 1640 | |
| Almera N15 / Hatchback | 2.0 | 55 | 07.95 - 00 | CD20E | 4 | █ | CY52 | 3017 | | | | |
| Almera N16/ATV10 | 2.2 | 82 | 09.03 - | YD22DDTi | 4 | █ | Y-519J | 2500 | | D-POWER 61 | 93293 | |
| Almera N16/ATV10 | 2.2 | 100 | 09.03 - | YD22DDTi | 4 | █ | Y-519J | 2500 | | D-POWER 61 | 93293 | |
| Almera dCi N16 | 1.5 | 60 | 01.03 - | K9K | 4 | █ | Y-732J | 5605 | | D-POWER 4 | 5605 | |
| Almera Gti N15 | 2.0 | 105 | 95 - 04.00 | SR20DE | 4 | 1,1 | BKR5EY-11 | 2355 | | LPG 1 | 1496 | |
| Almera Tino N16/ATV10 | 2.2 | 82 | 09.03 - | YD22DDTi | 4 | █ | Y-519J | 2500 | | D-POWER 61 | 93293 | |
| Almera Tino N16/ATV10 | 2.2 | 100 | 09.03 - | YD22DDTi | 4 | █ | Y-519J | 2500 | | D-POWER 61 | 93293 | |
| Almera Tino ATV10 | 1.8 | 84 | 00 - 02 | QG18DE | 4 | 1,1 | BKR5E-11 | 6953 | 33 | LPG 1 | 1496 | |
| Almera Tino ATV10 | 1.8 | 85 | 03 - | QG18DE | 4 | 1,1 | LFR5A-11 | 6376 | | LPG 7 | 1640 | |
| Almera Tino ATV10 | 2.0 | 100 | 00 - 02 | SR20DE | 4 | 1,1 | PFR6G-11 | 5555 | | PFR7G | 4364 | |
| Axxess M11 | 2.4 | | 93 - | KA24E | 6 | 1,1 | ZFR5E-11 | 4435 | | | | |
| Bluebird | 1.8 | | 90 - | CA18NS | 4 | 0,8 | BCP5ES | 7496 | 16 | LPG 3 | 1498 | |
| Bluebird | 1.8 | | - 89 | CA18S | 4 | 0,8 | BPR6ES | 7822 | 2 | LPG 2 | 1497 | |
| Bluebird | 1.8 | | 90 - | CA18S | 4 | 0,8 | BCP5ES | 7496 | 16 | LPG 3 | 1498 | |
| Bluebird 90 | 2.0 | 81 | 01.80 - 05.84 | L20B | 4 | 1,1 | BPR6ES-11 | 4824 | 13 | LPG 2 | 1497 | |
| Bluebird 910 | 1.6 | 66 | 01.80 - 05.84 | L16 | 4 | 0,9 | BPR5ES | 7422 | 6 | LPG 2 | 1497 | |
| Bluebird 910 | 1.8 | 66 | 01.80 - 05.84 | L18S / L18T | 4 | 0,8 | BPR6ES | 7822 | 2 | LPG 2 | 1497 | |
| Bluebird 910 | 2.0 | 81 | 01.82 - 05.84 | Z20E | 4 | 1,1 | BPR6ES-11 | 4824 | 13 | LPG 2 | 1497 | |
| Bluebird T12 | 1.6 | 66 | 12.85 - 88 | CA16S | 4 | 0,8 | BCPR6ES | 2330 | 12 | LPG 3 | 1498 | |
| Bluebird T12 | 2.0 | 77 | 12.85 - | CA20S | 4 | 0,8 | BCPR6ES | 2330 | 12 | LPG 3 | 1498 | |
| Bluebird T72 | 1.6 | 62 | 09.88 - | CA16S | 4 | 0,8 | BCPR6ES | 2330 | 12 | LPG 3 | 1498 | |
| Bluebird T72 | 1.6 | | - 88 | CA16 | 4 | 0,8 | BCPR5ES | 6130 | 32 | LPG 3 | 1498 | |
| Bluebird T72 | 2.0 | 77 | 09.88 - 92 | CA20S | 4 | 0,8 | BCPR6ES | 2330 | 12 | LPG 3 | 1498 | |
| Bluebird T72 | 2.0 | 85 | 09.88 - | CA20E | 4 | 1,1 | BCPR6ES-11 | 7121 | 11 | LPG 3 | 1498 | |
| Bluebird U11 | 1.8 | 66 | 11.83 - 01.86 | CA18S | 4 | 0,8 | BPR6ES | 7822 | 2 | LPG 2 | 1497 | |
| Bluebird U11 | 2.0 | 75 | 11.83 - 01.86 | CA20S | 4 | 0,8 | BCPR6ES | 2330 | 12 | LPG 3 | 1498 | |
| Bluebird U13 | 1.6 | | 94 - | CA16NS | 4 | 0,8 | BCP5ES | 7496 | 16 | LPG 3 | 1498 | |
| Bluebird U13 | 2.0 | | 93 - | CA20E | 4 | 1,1 | BCPR6ES-11 | 7121 | 11 | LPG 3 | 1498 | |
| Bluebird U13 | 2.0 | | 93 - | CA20S | 4 | 0,7 | BCP6ES | 4930 | 17 | LPG 3 | 1498 | |
| Bluebird 16V T12 | 1.8 | 99 | 11.88 - 90 | CA18DE Cat. | 4 | 1,1 | PFR6A-11 | 4045 | | PFR6A-11 | 4045 | |
| Bluebird 16V T72 | 1.8 | 95 | 02.89 - 90 | CA18DE Cat. | 4 | 1,1 | PFR6A-11 | 4045 | | PFR6A-11 | 4045 | |
| Bluebird 4X EX + 4X IN T12 | 2.0 | 77 | 03.86 - 92 | CA20E Twin Spark Cat. | 4 | 1,1 | BCPR5ES-11 + | 3524+ | | | | |
| | | | | | | | BCPR6ES-11 | 7121 | | LPG 3 * 8 pieces | 1498 | |
| Bluebird 4X EX + 4X IN T72 | 2.0 | 77 | 09.88 - 90 | CA20E Twin Spark Cat. | 4 | 1,1 | BCPR5ES-11 + | 3524+ | | | | |
| | | | | | | | BCPR6ES-11 | 7121 | | LPG 3 * 8 pieces | 1498 | |
| Bluebird 4X EX + 4X IN U11 | 2.0 | 77 | 04.86 - 90 | CA20E Twin Spark Cat. | 4 | 1,1 | BCPR5ES-11 + | 3524+ | | | | |
| | | | | | | | BCPR6ES-11 | 7121 | | LPG 3 * 8 pieces | 1498 | |
| Bluebird Turbo T12 | 1.8 | 88 | 12.85 - | CA18T | 4 | 1,1 | BCPR6ES-11 | 7121 | 11 | LPG 3 | 1498 | |
| Bluebird Turbo T72 | 1.8 | 99 | 09.88 - | CA18T | 4 | 1,1 | BCPR6ES-11 | 7121 | 11 | LPG 3 | 1498 | |
| Bluebird Turbo U11 | 1.8 | 100 | 11.83 - 01.86 | CA18ET | 4 | 1,1 | BCPR6ES-11 | 7121 | 11 | LPG 3 | 1498 | |



ℓ kW



Cyl.

Order-
No. No.LPG/CNG Order-
D-Power No.**NISSAN**

| | | | | | | | | | | | | |
|-----------------------------|-----|-----|---------------|---------------|---|-----|------------|------|----|----------|------|--|
| Bluebird/819/910 | 2.0 | | 05.80 - 12.81 | LD20, LD20T | 4 | █ | Y-204TS-1 | 3829 | | | | |
| Bluebird/819/910 | 2.0 | | 01.82 - 87 | LD20, LD20T | 4 | █ | Y-204RS | 4573 | | | | |
| Bluebird/819/910 | 2.8 | | 06.80 - 08.81 | LD28 | | █ | Y-204TS-1 | 3829 | | | | |
| Bluebird/819/910 QGS Type 1 | 2.0 | | 01.81 - 12.83 | LD20, LD20T | 4 | █ | Y-204RS | 4573 | | | | |
| Bluebird/819/910 QGS Type 1 | 2.8 | | 08.81 - 12.83 | LD28 | | █ | Y-204RS | 4573 | | | | |
| Bluebird/819/910 QGS Type 2 | 2.0 | | 01.81 - 12.83 | LD20, LD20T | 4 | █ | Y-204SS | 7629 | | | | |
| Bluebird/819/910 QGS Type 2 | 2.8 | | 08.81 - 12.83 | LD28 | | █ | Y-204SS | 7629 | | | | |
| Bluebird/819/910 T12 | 2.0 | 47 | 12.85 - 02.90 | LD20 | 4 | █ | CY51 | 2696 | | | | |
| Bluebird/819/910 T72 | 2.0 | 49 | 09.88 - 04.90 | LD20 | 4 | █ | CY51 | 2696 | | | | |
| Bluebird/Hatchback T12 | 2.0 | 47 | 12.85 - 02.90 | LD20 | 4 | █ | CY51 | 2696 | | | | |
| Bluebird/Hatchback T72 | 2.0 | 49 | 09.88 - 04.90 | LD20 | 4 | █ | CY51 | 2696 | | | | |
| Brougham | 2.3 | | 93 - | TD23 | | █ | Y-707RS | 4937 | | | | |
| C120 / Vanette | 2.0 | | 87 - | LD20 | | █ | CY51 | 2696 | | | | |
| C120 / Vanette | 2.0 | | 06.81 - 09.82 | LD20 | | █ | Y-204TS-1 | 3829 | | | | |
| C120 / Vanette QGS Type 1 | 2.0 | | 09.82 - | LD20 | | █ | Y-204RS | 4573 | | | | |
| Caball | 2.2 | | 82 - | SD22 | | █ | Y-112R1 | 1032 | | | | |
| Caball | 3.0 | | 06.80 - 12.81 | ED30 | | █ | Y-222T | 7628 | | | | |
| Caball | 3.0 | | 12.81 - | ED30 | | █ | Y-272R-1 | 2731 | | | | |
| Cabstar | 2.2 | | 01.82 - | SD22 | | █ | Y-112R1 | 1032 | | | | |
| Cabstar | 2.3 | | | SD23 | | █ | Y-112M1 | 2531 | | | | |
| Cabstar | 2.3 | | | TD23 | | █ | Y-707RS | 4937 | | | | |
| Cabstar | 2.5 | | | SD25 | | █ | Y-112M1 | 2531 | | | | |
| Cabstar | 2.5 | | | TD25 | | █ | Y-707RS | 4937 | | | | |
| Cabstar | 2.7 | | | TD27 | | █ | Y-707RS | 4937 | | | | |
| Cabstar | 3.3 | | | ED33 | | █ | Y-955RS | 4995 | | | | |
| Cabstar | 3.3 | | | ED33 | | █ | Y-272R-1 | 2731 | | | | |
| Cabster | 2.3 | | | TD23 | | █ | Y-707RS | 4937 | | | | |
| Cabster | 3.3 | | | ED33 | | █ | Y-955RS | 4995 | | | | |
| Cabster F23/H41 | 1.6 | | 93 - | Z16 | 4 | 0,8 | BP5ES | 6511 | 8 | LPG 2 | 1497 | |
| Cabster F23/H41 | 2.0 | | 93 - | Z20 | 4 | 0,8 | BP5ES | 6511 | 8 | LPG 2 | 1497 | |
| Cabster F23/H41 | 2.0 | | | Z20S,NA20S | 4 | 0,9 | BPR5ES | 7422 | 6 | LPG 2 | 1497 | |
| Cabster F23/H41 | 2.4 | | 93 - | Z24 | 6 | 0,7 | BP6ES | 7811 | 4 | LPG 2 | 1497 | |
| Cabster F23 & H41 | 2.5 | | | TD25 | | █ | Y-707RS | 4937 | | | | |
| Cabster F23 & H41 | 2.7 | | | TD27 | | █ | Y-707RS | 4937 | | | | |
| Caravan | 2.0 | 120 | 01.01 - | KA20DE (DOHC) | 4 | 1,1 | BKR5E-11 | 6953 | 33 | LPG 1 | 1496 | |
| Caravan | 2.4 | | 01.01 - | KA24DE (DOHC) | 4 | 1,1 | BKR5E-11 | 6953 | 33 | LPG 1 | 1496 | |
| Cedric | 2.0 | 92 | 07.87 - | VG20E | 4 | 1,1 | BCPR6ES-11 | 7121 | 11 | LPG 3 | 1498 | |
| Cedric | 2.5 | | 06.00 - | VQ25DD | 4 | 1,1 | FR5BP-11 | 6247 | | | | |
| Cedric | 3.0 | 118 | 07.87 - | VG30E | 6 | 1,1 | BCPR6ES-11 | 7121 | 11 | LPG 3 | 1498 | |
| Cedric (MY34) | 2.5 | | 06.99 - 06.00 | VQ25DD Ne-Di | 4 | 1,1 | PFR5P-11 | 4341 | | PFR5P-11 | 4341 | |
| Cedric Turbo | 3.0 | 144 | 07.87 - 91 | VG30ET | 6 | 1,1 | BCPR6ES-11 | 7121 | 11 | LPG 3 | 1498 | |
| Cedric Turbo 24V | 2.0 | 136 | 07.87 - 91 | VG20DET | 6 | 1,1 | BCPR6ES-11 | 7121 | 11 | LPG 3 | 1498 | |
| Cedric/220C/280C | 2.3 | | 84 - | SD23 | | █ | Y-112R1 | 1032 | | | | |
| Cedric/220C/280C | 2.3 | | | TD23 | | █ | Y-707RS | 4937 | | | | |
| Cedric/220C/280C QGS Type 1 | 2.8 | | 06.82 - | LD28 | | █ | Y-204RS | 4573 | | | | |
| Cedric/220C/280C QGS Type 1 | 2.8 | | 06.82 - | LD28 | | █ | Y-204RS | 4573 | | | | |
| Cedric/220C/280C QGS Type 2 | 2.8 | | 06.82 - | LD28 | | █ | Y-204SS | 7629 | | | | |
| Cefiro | 2.5 | | 06.00 - | VQ25DD | 4 | 1,1 | FR5BP-11 | 6247 | | | | |
| Cefiro (PA33) | 2.5 | | 12.98 - 12.01 | VQ25DD Ne-Di | 4 | 1,1 | PFR5P-11 | 4341 | | PFR5P-11 | 4341 | |
| Cherry N12 | 1.0 | 37 | 05.82 - 05.86 | E10 | 4 | 0,9 | BPR5ES | 7422 | 6 | LPG 2 | 1497 | |
| Cherry N12 | 1.3 | 44 | 05.82 - 05.86 | E13 | 4 | 0,9 | BPR5ES | 7422 | 6 | LPG 2 | 1497 | |
| Cherry N12 | 1.5 | 51 | 05.82 - 05.86 | E15 | 4 | 0,9 | BPR5ES | 7422 | 6 | LPG 2 | 1497 | |



ℓ kW

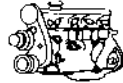

Cyl.

Order-
No.VLINE
No.LPG/CNG
D-PowerOrder-
No.**NISSAN**

| | | | | | | | | | | | | |
|----------------------|-----|----|-------------|---------------------------|------|---|-----|------------|------|----|-----------|------|
| Cherry N12 | 1.6 | 51 | 06.85-05.86 | E16 | Cat. | 4 | 1,1 | BPR5ES-11 | 4424 | | LPG 2 | 1497 |
| Cherry N12 | 1.7 | 45 | 87- | CD17 | | 4 | █ | CY51 | 2696 | | | |
| Cherry Turbo N12 | 1.5 | 77 | 07.83-05.86 | E15T | | 4 | 0,8 | BPR6ES | 7822 | 2 | LPG 2 | 1497 |
| Chery N12 QGS Type 1 | 1.7 | | 10.82- 86 | CD17 | | | █ | Y-117RS | 2930 | | | |
| Chery N12 QGS Type 2 | 1.7 | | 10.82- 86 | CD17 | | | █ | Y-117SS | 2231 | | | |
| Civilian | 2.2 | | 82- 86 | SD22 | | | █ | Y-112R1 | 1032 | | | |
| Civilian | 3.0 | | 06.80-12.81 | ED30 | | | █ | Y-222T | 7628 | | | |
| Civilian | 3.0 | | 12.81- 86 | ED30 | | | █ | Y-272R-1 | 2731 | | | |
| Civilian | 3.3 | | 87- 87 | ED33 | | | █ | Y-272R-1 | 2731 | | | |
| Civilian | 3.3 | | 04.88- | ED33 | | | █ | Y-955RS | 4995 | | | |
| Clipper | 2.2 | | 82- 87 | SD22 | | | █ | Y-112R1 | 1032 | | | |
| Clipper | 3.0 | | 06.80-12.81 | ED30 | | | █ | Y-222T | 7628 | | | |
| Clipper | 3.0 | | 12.81- | ED30 | | | █ | Y-272R-1 | 2731 | | | |
| D21 | 1.6 | | | Z 16S | | 4 | 0,7 | BP6ES | 7811 | 4 | LPG 2 | 1497 |
| D21 | 2.0 | | | Z 20S | | 4 | 0,8 | BPR6ES | 7822 | 2 | LPG 2 | 1497 |
| D21 | 2.4 | | | Z 24S | | 4 | 0,9 | BPR5ES | 7422 | 6 | LPG 2 | 1497 |
| D21 | 2.5 | | 93- | TD25 | | | █ | Y-707RS | 4937 | | | |
| D21 | 2.7 | | 93- | TD27 | | | █ | Y-707RS | 4937 | | | |
| D21 | 2.7 | | 93- | TD27T | | | █ | Y-712RS | 6140 | | | |
| D21 | 3.0 | | | VG30E | | 6 | 0,9 | BKR6EY | 3696 | | LPG 1 | 1496 |
| EXA | 1.8 | | | CA18DE | | 4 | 1,1 | PFR6A-11 | 4045 | | PFR6A-11 | 4045 |
| F22 | 2.3 | | | SD23 | | | █ | Y-162R1 | 2431 | | | |
| F22 | 2.3 | | | TD23 | | | █ | Y-707RS | 4937 | | | |
| F22 | 2.5 | | | SD25 | | | █ | Y-162R1 | 2431 | | | |
| F22 | 2.5 | | 12.81- | SD25 | | | █ | Y-112M1 | 2531 | | | |
| F22 | 2.5 | | | TD25 | | | █ | Y-707RS | 4937 | | | |
| F22 | 2.7 | | | TD27 | | | █ | Y-707RS | 4937 | | | |
| F22 | 3.3 | | | ED33 | | | █ | Y-955RS | 4995 | | | |
| F22 QGS Type 1 | 2.3 | | 02.82- | SD23 | | | █ | Y-112RS1 | 1132 | | | |
| Figaro (FK10) | 1.0 | | 01.91-05.92 | MA10T OHC Turbo | | 4 | 1,1 | BPR6ES-11 | 4824 | 13 | LPG 2 | 1497 |
| Gloria | 2.5 | | 06.00- | VQ25DD | | 4 | 1,1 | FR5BP-11 | 6247 | | | |
| Gloria (MY34) | 2.5 | | 06.99-06.00 | VQ25DD Ne-Di | | 4 | 1,1 | PFR5P-11 | 4341 | | PFR5P-11 | 4341 |
| Hommer | 2.2 | | 01.82- | SD22 | | | █ | Y-112R1 | 1032 | | | |
| Infiniti G20 | 2.0 | | 94- | SR20DE | | 4 | 0,9 | BKR6E | 6962 | 28 | LPG 1 | 1496 |
| Interstar 80 dCi | 1.9 | 60 | 07.02- | F9Q772 | | 4 | █ | Y-732J | 5605 | | D-POWER 4 | 5605 |
| Interstar 90 dCi | 2.2 | 66 | 07.02- | G9T722 | | 4 | █ | Y-517J | 3319 | | | |
| Junior | 2.2 | | 84- 84 | SD22 | | | █ | Y-112T | 6327 | | | |
| Junior | 2.5 | | | SD25 | | | █ | Y-112M1 | 2531 | | | |
| Kubistar 1.2 | 1.1 | 43 | 03- | D7F | | 4 | | BKR5EK | 7956 | 23 | LPG 1 | 1496 |
| Kubistar 1.2 16V | 1.2 | 55 | 04.06- | D4F-712 | | 4 | 0,8 | LZKAR7A | 6799 | | LZKAR7A | 6799 |
| Kubistar 1.6 16V | 1.6 | 70 | 09.03- | K4M-720 / 744 / 745 / 748 | | 4 | 0,9 | BKR6E | 6962 | 28 | LPG 1 | 1496 |
| Kubistar Cdi | 1.5 | 48 | 08.03- | K9K | | 4 | █ | Y-732J | 5605 | | D-POWER 4 | 5605 |
| Kubistar Cdi | 1.5 | 60 | 08.03- | K9K | | 4 | █ | Y-732J | 5605 | | D-POWER 4 | 5605 |
| Laurel | 2.0 | 71 | 01.81-12.84 | L20A | | 4 | 0,9 | BPR5ES | 7422 | 6 | LPG 2 | 1497 |
| Laurel | 2.0 | | 11.80-09.81 | LD20 | | | █ | Y-204TS-1 | 3829 | | | |
| Laurel | 2.4 | 83 | - 85 | L24 | | 6 | 0,8 | BPR6ES | 7822 | 2 | LPG 2 | 1497 |
| Laurel | 2.8 | | 11.80-09.81 | LD28 | | 6 | █ | Y-204TS-1 | 3829 | | | |
| Laurel A31 | 2.0 | | 93- | CA20S | | 4 | 0,7 | BCP6ES | 4930 | 17 | LPG 3 | 1498 |
| Laurel A31 | 2.0 | | 94- | RB20E | | 4 | 1,1 | BCPR5ES-11 | 3524 | | LPG 3 | 1498 |
| Laurel A31 | 2.4 | | 94- | RB24S | | 6 | 0,9 | BKR6E | 6962 | 28 | LPG 1 | 1496 |
| Laurel C32 | 2.0 | 77 | 01.85- | CA20S | | 4 | 0,8 | BCPR6ES | 2330 | 12 | LPG 3 | 1498 |
| Laurel C32 | 2.4 | 81 | 01.85- | L24S | | 6 | 0,8 | BPR6ES | 7822 | 2 | LPG 2 | 1497 |



l kW

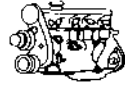

Cyl.

Order-
No. No.LPG/CNG
D-PowerOrder-
No.**NISSAN**

| | | | | | | | | | | | | |
|------------------|-----------------------------------|-----|-----|---------------|-------------|---|-----|-------------|-------|----|-------------|------|
| Laurel | C32 | 2.4 | 93 | 01.85 - | L24E | 6 | 1,1 | BCPR6ES-11 | 7121 | 11 | LPG 3 | 1498 |
| Laurel | C32 | 3.0 | 112 | 03.86 - | VG30E Cat. | 6 | 0,9 | BCPR6EY | 1146 | | LPG 3 | 1498 |
| Laurel | C32 | 3.0 | 122 | 01.85 - | VG30S | 6 | 1,1 | BCP6ES-11 | 7210 | | LPG 3 | 1498 |
| Laurel | QGS Type 1 | 2.8 | | 10.81 - | LD28 | 6 | █ | Y-204RS | 4573 | | | |
| Laurel | QGS Type 2 | 2.8 | | 10.81 - | LD28 | 6 | █ | Y-204SS | 7629 | | | |
| Laurel | C32 | 2.8 | | 02.87 - | RD28T | 6 | █ | CX51+ | 2896+ | | | |
| | (4,5,6 Cyl CX51.)(1,2,3 Cyl.CZ51) | | | | | | █ | CZ51 | 3209 | | | |
| Maxima | A33 | 2.0 | 103 | 00 - | VQ20DE | 6 | 1,1 | PFR6G-11 | 5555 | | PFR7G | 4364 |
| Maxima | A33 | 3.0 | 147 | 00 - | VQ30DE | 6 | 1,1 | PFR6G-11 | 5555 | | PFR7G | 4364 |
| Maxima | J30 | 3.0 | 125 | 10.88 - 95 | VG30E | 6 | 1,1 | BKR6ES-11 | 5553 | 14 | LPG 1 | 1496 |
| Maxima | J30 | 3.0 | | | VG30DE | 6 | 1,1 | PFR5C-11 | 2271 | | PFR5C-11 | 2271 |
| Maxima QX | A32 | 2.0 | 103 | 95 - 00 | VQ20DE | 6 | 1,1 | PFR6G-11 | 5555 | | PFR7G | 4364 |
| Maxima QX | A32 | 3.0 | 141 | 95 - 00 | VQ30DE | 6 | 1,1 | PFR6G-11 | 5555 | | PFR7G | 4364 |
| Micra | K11 | 1.0 | 44 | 00 - 02 | CG10DE | 4 | 1,1 | BKR5E-11 | 6953 | 33 | LPG 1 | 1496 |
| Micra | K11 | 1.5 | 42 | 98 - 00 | VJX | 4 | █ | Y-503J | 1009 | | D-POWER 10 | 1009 |
| Micra | K11 | 1.5 | 42 | 98 - 00 | VJZ | 4 | █ | Y-503J | 1009 | | D-POWER 10 | 1009 |
| Micra | K12 | 1.2 | 48 | 02.03 - | CR12DE | 4 | 1,1 | LFR5AP-11 | 4775 | | LPG 7 | 1640 |
| Micra | K12 | 1.2 | 59 | 02.03 - | CR12DE | 4 | 1,1 | LFR5AP-11 | 4775 | | LPG 7 | 1640 |
| Micra | K12 | 1.4 | 65 | 02.03 - | CR14DE | 4 | 1,1 | LFR5AP-11 | 4775 | | LPG 7 | 1640 |
| Micra | K12 | 1.6 | 81 | 07.05 - | | 4 | 1,1 | LFR5AP-11 | 4775 | | LPG 7 | 1640 |
| Micra | K9 | 1.5 | | 04.84 - | TUD5 | 4 | █ | Y-503J | 1009 | | D-POWER 10 | 1009 |
| Micra | K10 | 1.0 | 37 | 12.82 - 92 | MA10S | 4 | 0,9 | BPR5ES | 7422 | 6 | LPG 2 | 1497 |
| Micra | K10 | 1.0 | 40 | 93 - | MA10 | 4 | 0,9 | BPR5ES | 7422 | 6 | LPG 2 | 1497 |
| Micra | K10 | 1.2 | 40 | 01.86 - 93 | MA12 | 4 | 1,1 | BPR5ES-11 | 4424 | | LPG 2 | 1497 |
| Micra | K10 | 1.2 | 42 | 07.86 - 11.88 | MA12S Cat. | 4 | 1,1 | BPR5ES-11 | 4424 | | LPG 2 | 1497 |
| Micra | K10 | 1.2 | 44 | 07.86 - 11.88 | MA12S | 4 | 1,1 | BPR5ES-11 | 4424 | | LPG 2 | 1497 |
| Micra SR160 | K12 | 1.6 | 85 | 07 - | HR16DE | 4 | 1,1 | PLZKAR6A-11 | 5118 | | PLZKAR6A-11 | 5118 |
| Micra dCi | K12 | 1.5 | 48 | 04.03 - | K9K | 4 | █ | Y-732J | 5605 | | D-POWER 4 | 5605 |
| Micra dCi | K12 | 1.5 | 60 | 09.03 - | K9K | 4 | █ | Y-732J | 5605 | | D-POWER 4 | 5605 |
| Micra 16 V Sport | K11 | 1.3 | 60 | 00 - 02 | CGA3DE | 4 | 1,1 | BKR5E-11 | 6953 | 33 | LPG 1 | 1496 |
| Micra C+C | K12 | 1.6 | 81 | 06 - | | 4 | 1,1 | LFR5AP-11 | 4775 | | LPG 7 | 1640 |
| Micra 16V | K11 | 1.0 | 40 | 93 - 00 | CG10DE Cat. | 4 | 1,1 | BKR5E-11 | 6953 | 33 | LPG 1 | 1496 |
| Micra 16V | K11 | 1.3 | 55 | 93 - 00 | CG13DE Cat. | 4 | 1,1 | BKR5E-11 | 6953 | 33 | LPG 1 | 1496 |
| Micra Super S | K10 | 1.3 | 55 | 93 - | CG13DE | 4 | 1,1 | BKR5E-11 | 6953 | 33 | LPG 1 | 1496 |
| Murano 2.5 | | 2.5 | | 09.04 - | QR25DE | 4 | 1,1 | LFR5A-11 | 6376 | | LPG 7 | 1640 |
| Murano 3.5 | | 3.5 | 172 | 12.02 - | VQ35DE | 6 | 1,1 | PLFR5A-11 | 6240 | | LPG 7 | 1640 |
| Nomad | | 2.0 | | | LD20 | | █ | CY51 | 2696 | | | |
| Note | | 1.4 | 65 | 03.06 - | CR14DE | 4 | 1,1 | LFR5AP-11 | 4775 | | LPG 7 | 1640 |
| Note | | 1.6 | 81 | 03.06 - | | 4 | 1,1 | PLFR5A-11 | 6240 | | LPG 7 | 1640 |
| Note | | 1.6 | 85 | 03.06 - | HR16DE | 4 | 1,1 | PLZKAR6A-11 | 5118 | | PLZKAR6A-11 | 5118 |
| Note dCi | | 1.5 | 50 | 03.06 - | | 4 | █ | Y-732J | 5605 | | D-POWER 4 | 5605 |
| Note dCi | | 1.5 | 63 | 03.06 - | | 4 | █ | Y-732J | 5605 | | D-POWER 4 | 5605 |
| Pathfinder | D21 | 2.0 | | | Z20S | 4 | 0,8 | BPR6ES | 7822 | 2 | LPG 2 | 1497 |
| Pathfinder | D21 | 2.4 | | | KA24 | 6 | 1,1 | ZFR5E-11 | 4435 | | | |
| Pathfinder | D21 | 2.4 | | | Z24i | 6 | 0,9 | BPR5ES | 7422 | 6 | LPG 2 | 1497 |
| Pathfinder | D21 | 2.4 | | | Z24S | 6 | 0,8 | BPR6ES | 7822 | 2 | LPG 2 | 1497 |
| Pathfinder | D21 | 2.5 | | 93 - | TD25 | 4 | █ | Y-707RS | 4937 | | | |
| Pathfinder | D21 | 2.7 | | 93 - | TD27 | 4 | █ | Y-707RS | 4937 | | | |
| Pathfinder | D21 | 2.7 | | 93 - | TD27T | 4 | █ | Y-712RS | 6140 | | | |
| Pathfinder | D21 | 3.0 | | 92 - | VG30E | 6 | 0,9 | BKR6EY | 3696 | | LPG 1 | 1496 |
| Pathfinder | D21 | 3.0 | | | VG30i | 6 | 1,1 | BCPR5ES-11 | 3524 | | LPG 3 | 1498 |
| Pathfinder | R50 | 3.3 | 110 | 92 - 12.00 | VG33E V6 | 6 | 1,1 | BKR5E-11 | 6953 | 33 | LPG 1 | 1496 |



ℓ kW



Cyl.

Order-
No.LPG/CNG
D-PowerOrder-
No.**NISSAN**

| | | | | | | | | | | | |
|-----------------------------------|-----|-----|-------------|------------------------|---|-----|------------|-------|----|-------|------|
| Pathfinder R50 | 3.3 | 110 | 97 - 00 | VG33E V6 | 6 | 1,1 | BKR5ES-11 | 2382 | 33 | LPG 1 | 1496 |
| Pathfinder R50 | 3.5 | 162 | 01.00 - | VQ35E V6 | 6 | 1,1 | PLFR5A-11 | 6240 | | LPG 7 | 1640 |
| Pathfinder R51M | 4.0 | 198 | 09.05 - | VQ40DE | 6 | 1,1 | LF5AIX-11 | 4469 | | LPG 7 | 1640 |
| Patrol | 2.7 | | 02.93 - | TD27 | 6 | █ | Y-707RS | 4937 | | | |
| Patrol | 3.3 | | -06.80 | SD33 | 6 | █ | Y-103 | 6125 | | | |
| Patrol | 3.3 | | 06.80-08.82 | SD33 | 6 | █ | Y-181T | 2728 | | | |
| Patrol | 3.3 | | 08.82-11.84 | SD33 12V | 6 | █ | Y-112M1 | 2531 | | | |
| Patrol | 3.3 | | 11.84 - | SD33 12V | 6 | █ | Y-705RS | 1249 | | | |
| Patrol | 3.3 | | 08.82-11.84 | SD33 24V | 6 | █ | Y-162R1 | 2431 | | | |
| Patrol | 3.3 | | 11.84 - | SD33 24V | 6 | █ | Y-755RS | 7771 | | | |
| Patrol | 3.3 | | -11.84 | SD33T 12V | 6 | █ | Y-112M1 | 2531 | | | |
| Patrol | 3.3 | | 11.84 - | SD33T 12V | 6 | █ | Y-705RS | 1249 | | | |
| Patrol | 3.3 | | -11.84 | SD33T 24V | 6 | █ | Y-162R1 | 2431 | | | |
| Patrol | 3.3 | | 11.84 - | SD33T 24V | 6 | █ | Y-755RS | 7771 | | | |
| Patrol | 4.2 | | - 92 | TB42S | 6 | 0,8 | BP5ES | 6511 | 8 | LPG 2 | 1497 |
| Patrol | 4.2 | | | TD42 12V | 6 | █ | Y-707RS | 4937 | | | |
| Patrol | 4.2 | | | TD42 24V | 6 | █ | Y-757RS | 4018 | | | |
| Patrol | 4.5 | | 98 - | TB45E | 6 | 1,1 | BPR5E-11 | 5638 | | LPG 2 | 1497 |
| Patrol 160 | 2.8 | 88 | 07.80-08.88 | L28 | 6 | 0,8 | BPR6ES | 7822 | 2 | LPG 2 | 1497 |
| Patrol 260 | 2.8 | 88 | 02.87-03.89 | L28 | 6 | 0,8 | BPR6ES | 7822 | 2 | LPG 2 | 1497 |
| Patrol Y60 | 4.2 | | 93 - 94 | RB42S | 6 | 0,9 | BPR5E | 7281 | 6 | LPG 2 | 1497 |
| Patrol Y60 | 4.2 | | 93 - | TB42E | 6 | 0,9 | BPR5E | 7281 | 6 | LPG 2 | 1497 |
| Patrol Y60 | 4.2 | | 88-12.95 | TB42S | 6 | 0,7 | BP6ES | 7811 | 4 | LPG 2 | 1497 |
| Patrol Y60 & 260 | 2.0 | | 04.89 - | RB30S | 4 | 0,9 | BKR6E | 6962 | 28 | LPG 1 | 1496 |
| Patrol Y61 | 2.8 | 95 | 04.98 - | RD28 only if NGK is OE | 6 | █ | CX51+ | 2896+ | | | |
| (4,5,6 Cyl CX51.)(1,2,3 Cyl.CZ51) | | | | | | █ | CZ51 | 3209 | | | |
| Patrol / 160/ Y60 | 2.8 | | | RD28T | 6 | █ | CX51+ | 2896+ | | | |
| (4,5,6 Cyl CX51.)(1,2,3 Cyl.CZ51) | | | | | | █ | CZ51 | 3209 | | | |
| Patrol 160 | 4.2 | | -12.98 | TD42 12V | 6 | █ | Y-707RS | 4937 | | | |
| Patrol 160 | 4.2 | | -12.98 | TD42 24V | 6 | █ | Y-757RS | 4018 | | | |
| Patrol 3.0 Di Y61 | 3.0 | 116 | 06 - 09 | ZD30DDTi | 6 | █ | Y-522J | 5939 | | | |
| | | | | only if NGK is OE | | | | | | | |
| Patrol 3.0 Di Y61 | 3.0 | 116 | 05.00 - 06 | ZD30DDTi | 6 | █ | CZ71 | 6836 | | | |
| | | | | only if NGK is OE | | | | | | | |
| Pick Up | 3.0 | | 93 - | VG30E | 6 | 0,9 | BKR6EY | 3696 | | LPG 1 | 1496 |
| Pick Up | 3.0 | | 90 - | VG30I | 6 | 1,1 | BCPR5ES-11 | 3524 | | LPG 3 | 1498 |
| Pick Up 720 | 2.2 | 71 | 03.86-04.93 | Z22 | 4 | 0,7 | BP6ES | 7811 | 4 | LPG 2 | 1497 |
| Pick Up B120 | 1.2 | | 93 - | A12 | 4 | 0,8 | BP5ES | 6511 | 8 | LPG 2 | 1497 |
| Pick Up B120 | 1.2 | | | A12S | 4 | 0,9 | BPR5ES | 7422 | 6 | LPG 2 | 1497 |
| Pick Up B120 | 1.5 | | | A15S | 4 | 0,9 | BPR5ES | 7422 | 6 | LPG 2 | 1497 |
| Pick Up D21 | 1.6 | | 09.85 - | Z16 | 4 | 0,8 | BPR6ES | 7822 | 2 | LPG 2 | 1497 |
| Pick Up D21 | 2.0 | | 09.85-04.92 | Z20 | 4 | 0,8 | BPR6ES | 7822 | 2 | LPG 2 | 1497 |
| Pick Up D21 | 2.0 | | 04.92 - | Z20S | 4 | 0,8 | BPR6ES | 7822 | 2 | LPG 2 | 1497 |
| Pick Up D21 | 2.4 | 74 | 09.85-04.92 | Z24 | 4 | 0,8 | BPR6ES | 7822 | 2 | LPG 2 | 1497 |
| Pick Up D21 | 2.4 | 76 | 10.88-04.92 | Z24i | 4 | 0,8 | BPR6ES | 7822 | 2 | LPG 2 | 1497 |
| Pick Up D22 | 2.4 | 88 | 98 - 01 | KA24E | 4 | 1,1 | ZFR5E-11 | 4435 | | | |
| Pick Up D22 | 2.4 | 98 | 02 - | KA24E | 4 | 1,1 | BKR6E-11 | 2756 | 14 | LPG 1 | 1496 |
| Pick Up MD21 | 2.4 | 93 | 94 - 98 | KA24E | 4 | 1,1 | ZFR5E-11 | 4435 | | | |
| Pick-Up | 2.7 | | | TD27T | 4 | █ | Y-712RS | 6140 | | | |
| Pick-Up 720 | 2.3 | | 87 - | SD23 | 4 | █ | Y-705RS | 1249 | | | |
| Pick-Up 720 | 2.5 | | 87 - | SD25 | 4 | █ | Y-705RS | 1249 | | | |
| Pick-Up 720 | 2.5 | | | TD25 | 4 | █ | Y-707RS | 4937 | | | |



ℓ kW



Cyl.

Order-
No. No.LPG/CNG Order-
D-Power No.**NISSAN**

| | | | | | | | | | | | |
|-----------------------------|-----|-----|---------------|-----------------------|---|-----|----------------------------|---------------|----|------------------|------|
| Pick-Up QGS Type 2 | 2.3 | | 84 - 86 | SD23 | 4 | █ | Y-112M1 | 2531 | | | |
| Pick-Up QGS Type 2 | 2.5 | | 84 - 86 | SD25 | 4 | █ | Y-112M1 | 2531 | | | |
| Pick-Up 720 QGS Type 1 | 2.3 | | 84 - 86 | SD23 | 4 | █ | Y-112R1 | 1032 | | | |
| Pick-Up 720 QGS Type 1 | 2.5 | | 83 - 86 | SD25 | 4 | █ | Y-112R1 | 1032 | | | |
| Pick-Up 720 | 2.7 | | | TD27 | 4 | █ | Y-707RS | 4937 | | | |
| Prairie M10 | 1.5 | 51 | 01.83 - 09.88 | E15S | 4 | 0,9 | BPR5ES | 7422 | 6 | LPG 2 | 1497 |
| Prairie M10 | 1.8 | 66 | 07.83 - 09.88 | CA18S | 4 | 0,8 | BPR6ES | 7822 | 2 | LPG 2 | 1497 |
| Prairie M10 | 2.0 | 67 | 01.86 - 09.88 | CA20S | 4 | 0,8 | BPR6ES | 7822 | 2 | LPG 2 | 1497 |
| Prairie M11 | 2.0 | 67 | 10.88 - 89 | CA20S | 4 | 0,8 | BPR6ES | 7822 | 2 | LPG 2 | 1497 |
| Prairie M11 | 2.0 | 98 | 93 - 95 | CA20S | 4 | 0,7 | BCP6ES | 4930 | 17 | LPG 3 | 1498 |
| Prairie M11 | 2.0 | | 90 - 92 | CA20S | 4 | 0,8 | BCPR6ES | 2330 | 12 | LPG 3 | 1498 |
| Prairie M11 | 2.4 | 98 | 94 - 95 | KA24E | | 1,1 | ZFR5E-11 | 4435 | | | |
| Prairie M11 | 3.0 | 98 | 92 - 95 | KA24E | 4 | 1,1 | ZFR5E-11 | 4435 | | | |
| Prairie 4 x EX + 4 x IN M10 | 2.0 | 72 | 01.86 - 09.88 | CA20E Twin Spark Cat. | 4 | 1,1 | BCPR5ES-11 + BCPR6ES-11 | 3524+ 7121 | | LPG 3 * 8 pieces | 1498 |
| Prairie 4 x EX + 4 x IN M11 | 2.0 | 72 | 10.88 - 92 | CA20E Twin Spark Cat. | 4 | 1,1 | BCPR5ES-11 + BCPR6ES-11 | 3524+ 7121 | | LPG 3 * 8 pieces | 1498 |
| Prairie 4 x EX + 4 x IN M11 | 2.0 | 73 | 10.88 - 92 | CA20E Twin Spark | 4 | 1,1 | BCPR5ES-11 + BCPR6ES-11 | 3524+ 7121 | | LPG 3 * 8 pieces | 1498 |
| Prairie 4 x EX + 4 x IN M11 | 2.0 | 98 | 93 - 95 | CA20E Twin Spark | 4 | 1,1 | BCPR5ES-11 + BCPR6ES-11 | 3524+ 7121 | | LPG 3 * 8 pieces | 1498 |
| President H250 | 4.4 | | 93 - | Y44S | 6 | 0,9 | BP4ES | 6928 | | | |
| Primastar J4 | 2.0 | 88 | 03 - | F4R | 4 | 0,9 | BKR6EZ | 4619 | 38 | LPG 1 | 1496 |
| Primastar 100 dCi | 1.9 | 74 | 03.01 - | | 4 | █ | Y-732J | 5605 | | D-POWER 4 | 5605 |
| Primastar 140 dCi | 2.5 | 99 | 09.03 - | G9U730 | 4 | █ | Y-517J | 3319 | | | |
| Primastar 80 dCi | 1.9 | 60 | 03.01 - | | 4 | █ | Y-732J | 5605 | | D-POWER 4 | 5605 |
| Primera P12 | 1.8 | 85 | 03.02 - | QG18DE | 4 | 1,1 | LFR5A-11 | 6376 | | LPG 7 | 1640 |
| Primera P10 | 1.6 | 66 | 93 - 96 | GA16DE | 4 | 0,8 | BKR5E | 7938 | 35 | LPG 1 | 1496 |
| Primera P10 | 1.6 | 66 | 93 - | GA16DS | 4 | 0,9 | BKR6EY | 3696 | | LPG 1 | 1496 |
| Primera P10 | 2.0 | 85 | 93 - 96 | SR20DE | 4 | 0,9 | BKR5EY | 7390 | | LPG 1 | 1496 |
| Primera P10E | 1.6 | 66 | 06.90 - 93 | GA16DS Cat. | 4 | 0,9 | BKR6E | 6962 | 28 | LPG 1 | 1496 |
| Primera P10E | 1.6 | 70 | 06.90 - 92 | GA16DS | 4 | 0,9 | BKR6E | 6962 | 28 | LPG 1 | 1496 |
| Primera P10E | 2.0 | 55 | 01.91 - 06.96 | CD20 | 4 | █ | CY52 | 3017 | | | |
| Primera P10E | 2.0 | 85 | 06.90 - 96 | SR20Di | 4 | 0,9 | BKR5EY | 7390 | | LPG 1 | 1496 |
| Primera P10E | 2.0 | 89 | 06.90 - 96 | SR20Di SPI | 4 | 0,9 | BKR5EY | 7390 | | LPG 1 | 1496 |
| Primera P10E | 2.0 | 110 | 06.90 - 96 | SR20DE EGI Cat. | 4 | 0,9 | BKR6EY | 3696 | | LPG 1 | 1496 |
| Primera P11 | 1.6 | 66 | 96 - | GA16DE | 4 | 0,9 | BKR6E | 6962 | 28 | LPG 1 | 1496 |
| Primera P11 | 1.6 | 78 | 02.00 - 07.02 | QG16DE | 4 | 1,1 | BKR5E-11 | 6953 | 33 | LPG 1 | 1496 |
| Primera P11 | 1.8 | 83 | 02.00 - 02 | QG18DE | 4 | 1,1 | BKR5E-11 | 6953 | 33 | LPG 1 | 1496 |
| Primera P11 | 2.0 | 91 | 96 - 99 | SR20DE | 4 | 0,9 | BKR5EY | 7390 | | LPG 1 | 1496 |
| Primera P11 | 2.0 | 103 | 00 - 02 | SR20DE | 4 | 1,1 | PFR6G-11 | 5555 | | PFR7G | 4364 |
| Primera P11 | 2.0 | 109 | 96 - 99 | SR20DE | 4 | 0,9 | BKR5EY | 7390 | | LPG 1 | 1496 |
| Primera P11 | 2.0 | 110 | 06.97 - 99 | SR20DE | 4 | 0,9 | BKR6EY | 3696 | | LPG 1 | 1496 |
| Primera P12 | 1.6 | 78 | 02 - | QG16DE | 4 | 1,1 | LFR5A-11 | 6376 | | LPG 7 | 1640 |
| Primera P12 | 2.0 | 103 | 03.02 - | QR20DE | 4 | 1,1 | LFR5A-11 | 6376 | | LPG 7 | 1640 |
| Primera W10 | 1.6 | 66 | 93 - 97 | GA16DE | 4 | 0,9 | BKR5EY | 7390 | | LPG 1 | 1496 |
| Primera W10 | 1.6 | 66 | 93 - | GA16DS | 4 | 0,9 | BKR6E | 6962 | 28 | LPG 1 | 1496 |
| Primera W10 | 1.6 | 66 | 07.90 - 93 | GA16DS Cat. | 4 | 0,9 | BKR6E | 6962 | 28 | LPG 1 | 1496 |
| Primera W10 | 1.6 | 70 | 07.90 - 93 | GA16DS | 4 | 0,9 | BKR6E | 6962 | 28 | LPG 1 | 1496 |
| Primera W10 | 2.0 | 85 | 07.90 - 96 | SR20Di | 4 | 0,9 | BKR5EY | 7390 | | LPG 1 | 1496 |
| Primera W10 | 2.0 | 89 | 07.90 - 96 | SR20Di SPI | 4 | 0,9 | BKR5EY | 7390 | | LPG 1 | 1496 |
| Primera HP12 | 2.0 | | 08.01 - 06.03 | SR20VE | 4 | 0,9 | PLFR6A-9 | 4342 | | LPG 7 | 1640 |



ℓ kW



Cyl.

Order-
No.VLINE
No.LPG/CNG
D-PowerOrder-
No.**NISSAN**

| | | | | | | | | | | | |
|-------------------------------------|-----|-----|---------------|-----------------|---|-----|----------------------------|---------------|----|------------------|-------|
| Primera 16V P11 | 1.6 | 74 | 09.96 - 00 | GA16DE | 4 | 0,8 | BKR5E | 7938 | 35 | LPG 1 | 1496 |
| Primera 16V P11 | 2.0 | 85 | 09.96 - 99 | SR20DE | 4 | 1,1 | BKR5EY-11 | 2355 | | LPG 1 | 1496 |
| Primera 16V P11 | 2.0 | 96 | 09.96 - 99 | SR20DE | 4 | 1,1 | BKR5EY-11 | 2355 | | LPG 1 | 1496 |
| Primera Di P12 | 2.2 | 93 | 03.02 - | YD22ET | 4 | █ | Y-519J | 2500 | | D-POWER 61 | 93293 |
| Primera / Wagon W10 | 2.0 | 55 | 07.90 - 04.96 | CD20 | 4 | █ | CY52 | 3017 | | | |
| Primera 1.9 dCi P12 | 1.9 | 88 | 09.03 - | F9Q... | 4 | █ | Y-732J | 5605 | | D-POWER 4 | 5605 |
| Primera GT (made in UK) | 2.0 | 110 | 04.97 - | SR20DE | 4 | 1,1 | BKR5EY-11 | 2355 | | LPG 1 | 1496 |
| Primera Traveller P12 | 1.8 | 85 | 03.02 - | QG18DE | 4 | 1,1 | LFR5A-11 | 6376 | | LPG 7 | 1640 |
| Primera Wagon WHP12 | 2.0 | | 08.01 - 06.03 | SR20VE | 4 | 0,9 | PLFR6A-9 | 4342 | | LPG 7 | 1640 |
| Pulsar N12 | 1.3 | 55 | 04.82 - 05.86 | E13 | 4 | 0,8 | BP5ES | 6511 | 8 | LPG 2 | 1497 |
| Pulsar N12 | 1.5 | 63 | 04.82 - 05.86 | E15 | 4 | 0,8 | BP5ES | 6511 | 8 | LPG 2 | 1497 |
| Pulsar N13 | 1.0 | 37 | 06.86 - | E10S | 4 | 0,8 | BP5ES | 6511 | 8 | LPG 2 | 1497 |
| Pulsar N13 | 1.3 | 50 | 06.86 - | E13S | 4 | 0,8 | BP5ES | 6511 | 8 | LPG 2 | 1497 |
| Pulsar N13 | 1.4 | | 10.88 - | GA14S | 4 | 0,7 | BCP6ES | 4930 | 17 | LPG 3 | 1498 |
| Pulsar N13 | 1.6 | 54 | 06.86 - | E16i Cat. | 4 | 1,1 | BPR6ES-11 | 4824 | 13 | LPG 2 | 1497 |
| Pulsar N13 | 1.6 | 62 | 06.86 - | E16i | 4 | 1,1 | BPR6ES-11 | 4824 | 13 | LPG 2 | 1497 |
| Pulsar N13 | 1.6 | 62 | 06.86 - | E16S | 4 | 0,8 | BPR6ES | 7822 | 2 | LPG 2 | 1497 |
| Pulsar N13 | 1.6 | 81 | 02.87 - 10.88 | CA16D DOHC Cat. | 4 | 1,1 | PFR6A-11 | 4045 | | PFR6A-11 | 4045 |
| Pulsar N13 | 1.6 | 88 | 02.87 - 10.88 | CA16D DOHC | 4 | 1,1 | BCPR6ES-11 | 7121 | 11 | LPG 3 | 1498 |
| Pulsar N13 | 1.6 | | 10.88 - | GA16S | 4 | 0,7 | BCP6ES | 4930 | 17 | LPG 3 | 1498 |
| Pulsar N13 | 1.8 | 92 | 10.88 - | CA18D DOHC | 4 | 1,1 | PFR6A-11 | 4045 | | PFR6A-11 | 4045 |
| Pulsar / Cherry / N12 QGS Type 1 | 1.7 | | 10.82 - 87 | CD17 | 4 | █ | Y-117RS | 2930 | | | |
| Pulsar / Cherry / N12 QGS Type 2 | 1.7 | | 10.82 - 87 | CD17 | 4 | █ | Y-117SS | 2231 | | | |
| Pulsar / Cherry / N13 | 1.7 | 41 | 05.86 - 08.90 | CD17 | 4 | █ | CY51 | 2696 | | | |
| Pulsar NX | 1.6 | | 90 - | GA16i | 4 | 1,1 | BCPR5ES-11 | 3524 | | LPG 3 | 1498 |
| Qashqai 1.6 | 1.6 | 84 | 02.07 - | HR16DE | 4 | 1,1 | PLZKAR6A-11 | 5118 | | PLZKAR6A-11 | 5118 |
| Qashqai 2.0 | 2.0 | 104 | 02.07 - | MR20DE | 4 | 1,1 | PLZKAR6A-11 | 5118 | | PLZKAR6A-11 | 5118 |
| QX4 | 3.5 | | 01 - | VQ35DE | 6 | 1,1 | PFR5G-11 | 2647 | | PFR6G-11 | 5555 |
| Santana Turbo | 1.6 | 53 | 01.84 - 01.87 | CY | 4 | █ | Y-918J | 6285 | | D-POWER 2 | 6285 |
| Sentra | 1.7 | | 87 - | CD17 | 4 | █ | CY51 | 2696 | | | |
| Sentra QGS Type 1 | 1.7 | | 10.82 - 86 | CD17 | 4 | █ | Y-117RS | 2930 | | | |
| Sentra QGS Type 2 | 1.7 | | 10.82 - 86 | CD17 | 4 | █ | Y-117SS | 2231 | | | |
| Serena C23 | 1.6 | 71 | 07.93 - | GA16DE Cat. | 4 | 0,8 | BKR5E | 7938 | 35 | LPG 1 | 1496 |
| Serena C23 | 2.0 | 93 | 01.92 - | SR20DE Cat. | 4 | 0,9 | BKR5EY | 7390 | | LPG 1 | 1496 |
| Serena C23 | 2.3 | 55 | 01.95 - 02.98 | LD23 | 4 | █ | Y-712RS | 6140 | | | |
| Serena C23 | 2.3 | 55 | 03.98 - | LD23 | 4 | █ | Y-530J | 6586 | | | |
| Serena C23M | 2.0 | 49 | 07.92 - 01.96 | LD20 | 4 | █ | CY51 | 2696 | | | |
| Serena C25/NC25 | 2.0 | | 05.05 - | MR20DE | 4 | 1,1 | LZKAR6AP-11 | 6643 | | LZKAR6AP-11 | 6643 |
| Silvia S12 | 2.0 | 107 | 10.83 - | CA20E | 4 | 0,7 | BCP6ES | 4930 | 17 | LPG 3 | 1498 |
| Silvia S12 | 2.0 | 107 | 10.83 - | FJ20E | 4 | 1,1 | BPR6ES-11 | 4824 | 13 | LPG 2 | 1497 |
| Silvia S12 | 2.0 | 111 | 10.83 - | FJ20E | 4 | 1,1 | BPR6ES-11 | 4824 | 13 | LPG 2 | 1497 |
| Silvia RS12 4x EX + 4 x IN | 1.8 | 90 | 89 - 95 | CA18E | 4 | 1,1 | BCPR5ES-11 + BCPR6ES-11 | 3524+ 7121 | | LPG 3 * 8 pieces | 1498 |
| Silvia Turbo S12 | 1.8 | 90 | 10.83 - | CA18ET Cat. | 4 | 1,1 | BCPR6ES-11 | 7121 | 11 | LPG 3 | 1498 |
| Silvia Turbo S12 | 1.8 | 101 | 10.83 - | CA18ET | 4 | 1,1 | BCPR6ES-11 | 7121 | 11 | LPG 3 | 1498 |
| Silvia Turbo 4x EX + 4 x IN S12(CH) | 1.8 | 90 | 10.83 - 95 | CA18ET Cat. | 4 | 1,1 | BCPR5ES-11 + BCPR6ES-11 | 3524+ 7121 | | LPG 3 * 8 pieces | 1498 |
| Skyline | 2.0 | 72 | 09.85 - | CA20S | 4 | 0,7 | BCP6ES | 4930 | 17 | LPG 3 | 1498 |
| Skyline | 2.6 | | 98 - | RB26DETT | 6 | 1,1 | PFR7A-11 | 4579 | | PFR7A-11 | 4579 |
| Skyline V6 24V HV35 | 3.0 | 191 | 02 - | VQ30DD | 6 | 1,1 | LFR5AIX-11 | 4469 | | LPG 7 | 1640 |
| Skyline V6 24V V35 | 2.5 | 158 | 02 - | VQ25DD | 6 | 1,1 | LFR5AIX-11 | 4469 | | LPG 7 | 1640 |
| Skyline V6 24V V35 | 3.5 | 200 | 02 - | VQ35DE | 6 | 1,1 | LFR5AIX-11 | 4469 | | LPG 7 | 1640 |



l kW



Cyl.

Order-
No. No.LPG/CNG
D-PowerOrder-
No.**NISSAN**

| | | | | | | | | | | | | |
|-----------------------------|-----|----|---------------|------------------|---|-----|--------------|-------|----|------------------|--|------|
| Skyline / 180K | 2.0 | | 06.80 - 09.81 | LD20 | 4 | █ | Y-204TS-1 | 3829 | | | | |
| Skyline / 180K | 2.8 | | 06.80 - 09.81 | LD28 | | █ | Y-204TS-1 | 3829 | | | | |
| Skyline / 180K QGS Type 1 | 2.0 | | 10.81 - | LD20 | 4 | █ | Y-204RS | 4573 | | | | |
| Skyline / 180K QGS Type 1 | 2.8 | | 10.81 - | LD28 | | █ | Y-204RS | 4573 | | | | |
| Skyline / 180K QGS Type 2 | 2.0 | | 10.81 - | LD20 | 4 | █ | Y-204SS | 7629 | | | | |
| Skyline / 180K QGS Type 2 | 2.8 | | 08.81 - | LD28 | | █ | Y-204SS | 7629 | | | | |
| Stanza | 2.0 | | | CA20S | 4 | 1,1 | BCPR6ES-11 | 7121 | 11 | LPG 3 | | 1498 |
| Stanza T11 | 1.6 | 60 | 08.81 - 12.85 | CA16S | 4 | 0,8 | BPR6ES | 7822 | 2 | LPG 2 | | 1497 |
| Stanza T11 | 1.8 | 65 | 08.81 - 12.85 | CA18S | 4 | 0,8 | BPR6ES | 7822 | 2 | LPG 2 | | 1497 |
| Stanza / T11 | 1.7 | | | CD17T | 4 | █ | Y-120RS | 7463 | | | | |
| Stanza / T11 | 2.0 | | 87 - | LD20 | 4 | █ | CY51 | 2696 | | | | |
| Stanza 4 x EX + 4 x IN | 2.0 | | | CA20 Twin Spark | 4 | 1,1 | BPR5ES-11+ | 4424+ | | LPG 3 * 8 pieces | | 1497 |
| | | | | | | | BPR6ES-11 | 4824 | | | | |
| Stanza 4 x EX + 4 x IN HT11 | 2.0 | 77 | 85 - 86 | CA20E Twin Spark | 4 | 1,1 | BCPR5ES-11 + | 3524+ | | LPG 3 * 8 pieces | | 1498 |
| | | | | | | | BCPR6ES-11 | 7121 | | | | |
| Stanza Turbo | 1.8 | | | CA18ET | 4 | 1,1 | BCPR6ES-11 | 7121 | 11 | LPG 3 | | 1498 |
| Sunny B11 | 1.3 | 44 | 03.82 - 12.85 | E13S | 4 | 0,8 | BPR6ES | 7822 | 2 | LPG 2 | | 1497 |
| Sunny B11 | 1.5 | 51 | 03.82 - 05.88 | E15S | 4 | 0,8 | BPR6ES | 7822 | 2 | LPG 2 | | 1497 |
| Sunny B11 | 1.6 | 51 | 03.85 - 05.88 | E16 Cat. | 4 | 1,1 | BPR6ES-11 | 4824 | 13 | LPG 2 | | 1497 |
| Sunny B12 | 1.0 | 37 | 01.86 - 09.88 | E10S | 4 | 0,9 | BPR5ES | 7422 | 6 | LPG 2 | | 1497 |
| Sunny B12 | 1.3 | 44 | 01.86 - | E13S | 4 | 0,9 | BPR5ES | 7422 | 6 | LPG 2 | | 1497 |
| Sunny B12 | 1.4 | | 10.88 - | GA14S | 4 | 0,8 | BCPR6ES | 2330 | 12 | LPG 3 | | 1498 |
| Sunny B12 | 1.5 | 52 | 01.86 - 10.88 | E15S | 4 | 0,7 | BP6ES | 7811 | 4 | LPG 2 | | 1497 |
| Sunny B12 | 1.6 | 62 | 10.88 - 90 | CA16S | 4 | 1,1 | BPR6ES-11 | 4824 | 13 | LPG 2 | | 1497 |
| Sunny B12 | 1.6 | 62 | 10.88 - 90 | CA16S | 4 | 0,8 | BCPR6ES | 2330 | 12 | LPG 3 | | 1498 |
| Sunny B12 | 1.6 | 62 | 06.86 - 10.88 | E16S | 4 | 0,8 | BPR6ES | 7822 | 2 | LPG 2 | | 1497 |
| Sunny B12 | 1.6 | 66 | 10.88 - 90 | GA16i Cat. | 4 | 1,1 | BCPR6ES-11 | 7121 | 11 | LPG 3 | | 1498 |
| Sunny B12 | 1.6 | | 06.86 - 10.88 | E16i | 4 | 1,1 | BPR6ES-11 | 4824 | 13 | LPG 2 | | 1497 |
| Sunny B12 | 1.6 | | 01.86 - 10.88 | E16i Cat. | 4 | 1,1 | BPR6ES-11 | 4824 | 13 | LPG 2 | | 1497 |
| Sunny B12 | 1.6 | | 10.88 - 90 | GA16S | 4 | 0,8 | BCPR6ES | 2330 | 12 | LPG 3 | | 1498 |
| Sunny B12 | 1.7 | | 06.86 - 08.90 | CD17 | 4 | █ | CY51 | 2696 | | | | |
| Sunny B13 | 1.0 | | 93 - 95 | E10S Cat. | 4 | 0,8 | BP5ES | 6511 | 8 | LPG 2 | | 1497 |
| Sunny B13 | 1.3 | | 93 - 95 | GA13DS | 4 | 0,9 | BKR6E | 6962 | 28 | LPG 1 | | 1496 |
| Sunny B13 | 1.4 | 55 | 93 - 95 | GA14DS | 4 | 0,9 | BKR6E | 6962 | 28 | LPG 1 | | 1496 |
| Sunny B13 | 1.6 | | - 96 | GA16DE | 4 | 0,9 | BKR6E | 6962 | 28 | LPG 1 | | 1496 |
| Sunny B13 | 1.6 | | - 95 | GA16DS | 4 | 0,9 | BKR6E | 6962 | 28 | LPG 1 | | 1496 |
| Sunny B13 | 1.7 | 40 | 93 - 96 | CD17 | 4 | █ | CY51 | 2696 | | | | |
| Sunny B13 | 2.0 | | 91 - 96 | SR20DE | 4 | 0,9 | BKR6EY | 3696 | | LPG 1 | | 1496 |
| Sunny B14 | 1.3 | | 95 - | GA13DE | 4 | 1,1 | BKR6E-11 | 2756 | 14 | LPG 1 | | 1496 |
| Sunny B14 | 1.3 | | 95 - | GA13DS | 4 | 0,9 | BKR6E | 6962 | 28 | LPG 1 | | 1496 |
| Sunny B14 | 1.4 | | 95 - | GA14DE | 4 | 0,9 | BKR6E | 6962 | 28 | LPG 1 | | 1496 |
| Sunny B14 | 1.6 | | 95 - | GA16DE | 4 | 1,1 | BKR6E-11 | 2756 | 14 | LPG 1 | | 1496 |
| Sunny B14 | 1.8 | | 95 - | GA18DE(A) | 4 | 1,1 | BKR6E-11 | 2756 | 14 | LPG 1 | | 1496 |
| Sunny B14 | 1.8 | | 95 - | GA18DE(B) | 4 | 0,9 | BKR6E | 6962 | 28 | LPG 1 | | 1496 |
| Sunny B14 | 2.0 | 55 | 10.90 - | CD20 | 4 | █ | CY52 | 3017 | | | | |
| Sunny B14 | 2.0 | | | CD20 | 4 | █ | CY51 | 2696 | | | | |
| Sunny B14 | 2.0 | | 95 - | SR20DE | 4 | 0,9 | BKR6EY | 3696 | | LPG 1 | | 1496 |
| Sunny N13 | 1.0 | 37 | 06.86 - 10.88 | E10S | 4 | 0,8 | BPR6ES | 7822 | 2 | LPG 2 | | 1497 |
| Sunny N13 | 1.0 | | 10.88 - 91 | E10S | 4 | 0,9 | BPR5ES | 7422 | 6 | LPG 2 | | 1497 |
| Sunny N13 | 1.3 | 49 | 06.86 - 10.88 | E13S | 4 | 0,8 | BPR6ES | 7822 | 2 | LPG 2 | | 1497 |
| Sunny N13 | 1.4 | 55 | 10.88 - 91 | GA14S | 4 | 0,7 | BCP6ES | 4930 | 17 | LPG 3 | | 1498 |
| Sunny N13 | 1.5 | 52 | 06.86 - 10.88 | E15S | 4 | 0,8 | BPR6ES | 7822 | 2 | LPG 2 | | 1497 |



ℓ kW



Cyl.

Order-
No.V-LINE
No.LPG/CNG
D-PowerOrder-
No.**NISSAN**

| | | | | | | | | | | | |
|---------------------------------|-----|-----|---------------|-------------------|---|-----|-------------|------|----|------------------|-------|
| Sunny N13 | 1.6 | 54 | 06.86 - 91 | E16i Cat. | 4 | 1,1 | BPR5ES-11 | 4424 | | LPG 2 | 1497 |
| Sunny N13 | 1.6 | 62 | 06.86 - 91 | E16i | 4 | 1,1 | BPR5ES-11 | 4424 | | LPG 2 | 1497 |
| Sunny N13 | 1.6 | 62 | 06.86 - 10.88 | E16S | 4 | 0,8 | BPR6ES | 7822 | 2 | LPG 2 | 1497 |
| Sunny N13 | 1.6 | 66 | 10.88 - 91 | GA16i Cat. | 4 | 1,1 | BCP6ES-11 | 7210 | | LPG 3 | 1498 |
| Sunny N13 | 1.6 | 88 | 02.87 - 10.88 | CA16D DOHC | 4 | 1,1 | BCPR6ES-11 | 7121 | 11 | LPG 3 | 1498 |
| Sunny N13 | 1.6 | | 10.88 - 91 | GA16S | 4 | 0,8 | BCPR6ES | 2330 | 12 | LPG 3 | 1498 |
| Sunny N13 | 1.7 | | 06.86 - 08.90 | CD17 | 4 | █ | CY51 | 2696 | | | |
| Sunny N14 | 1.4 | 55 | 10.92 - 95 | GA14DE | 4 | 0,8 | BKR5E | 7938 | 35 | LPG 1 | 1496 |
| Sunny N14 | 1.4 | 55 | 10.90 - 93 | GA14DS | 4 | 0,8 | BKR5E | 7938 | 35 | LPG 1 | 1496 |
| Sunny N14 | 1.6 | 66 | 10.92 - 95 | GA16DE | 4 | 0,8 | BKR5E | 7938 | 35 | LPG 1 | 1496 |
| Sunny N14 | 1.6 | 66 | 10.90 - 93 | GA16DS | 4 | 0,9 | BKR6E | 6962 | 28 | LPG 1 | 1496 |
| Sunny N14 | 1.6 | 75 | 10.92 - 95 | GA16DE | 4 | 0,8 | BKR5E | 7938 | 35 | LPG 1 | 1496 |
| Sunny N14 | 1.7 | | 91 - 91 | CD17 | 4 | █ | CY52 | 3017 | | | |
| Sunny N14 | 2.0 | 55 | 10.90 - 95 | CD20 | 4 | █ | CY52 | 3017 | | | |
| Sunny N14 | 2.0 | | 95 - | SR20DET | 4 | 0,6 | PFR7B | 4853 | | PFR8B | 2781 |
| Sunny N15 | 2.0 | 55 | 10.90 - 95 | CD20 | 4 | █ | CY52 | 3017 | | | |
| Sunny Y10 | 1.6 | 66 | 94 - 00 | GA16DS | 4 | 0,9 | BKR6E | 6962 | 28 | LPG 1 | 1496 |
| Sunny Y10 | 1.6 | 67 | 94 - 00 | SR16DE | 4 | 0,8 | BKR5E | 7938 | 35 | LPG 1 | 1496 |
| Sunny Y10 | 1.7 | 40 | 93 - 96 | CD17 | 4 | █ | CY51 | 2696 | | | |
| Sunny Y10 | 2.0 | 55 | 10.90 - 00 | CD20 | 4 | █ | CY52 | 3017 | | | |
| Sunny Y10 | 2.0 | 105 | 93 - 00 | GA20DE | 4 | 0,9 | BKR6EY | 3696 | | LPG 1 | 1496 |
| Sunny Y10L | 1.6 | 66 | 10.92 - 00 | GA16DE | 4 | 0,8 | BKR5E | 7938 | 35 | LPG 1 | 1496 |
| Sunny Y10L | 1.6 | 66 | 10.90 - 93 | GA16DS | 4 | 0,9 | BKR6E | 6962 | 28 | LPG 1 | 1496 |
| Sunny Y11 | 1.7 | 40 | 05.92 - 04.98 | CD17 | 4 | █ | CY51 | 2696 | | | |
| Sunny QGS Type 2 | 1.7 | | 10.82 - 84 | CD17 | 4 | █ | Y-117SS | 2231 | | | |
| Sunny 16V B12 | 1.6 | 88 | 01.86 - 09.88 | CA16DE | 4 | 1,1 | BCPR6ES-11 | 7121 | 11 | LPG 3 | 1498 |
| Sunny GTI B12 | 1.6 | 81 | 01.86 - 09.89 | CA16DE | 4 | 1,1 | PFR6A-11 | 4045 | | PFR6A-11 | 4045 |
| Sunny GTI B12 | 1.8 | 92 | 10.89 - 91 | CA18DE | 4 | 1,1 | PFR6A-11 | 4045 | | PFR6A-11 | 4045 |
| Sunny GTI N13 | 1.6 | 81 | 02.87 - 10.89 | CA16DE. | 4 | 1,1 | PFR6A-11 | 4045 | | PFR6A-11 | 4045 |
| Sunny GTI N13 | 1.8 | 92 | 10.89 - 91 | CA18DE | 4 | 1,1 | PFR6A-11 | 4045 | | PFR6A-11 | 4045 |
| Sunny GTI N14 | 2.0 | 105 | 10.90 - 05.95 | SR20DE Cat. | 4 | 0,9 | BKR6EY | 3696 | | LPG 1 | 1496 |
| Sunny GTI-R N14 | 2.0 | 162 | 10.93 - 95 | SR20DET Cat. | 4 | 0,9 | PFR7B-9 | 4180 | | PFR8B | 2781 |
| Sunny / Sentra / B11 QGS Type 1 | 1.7 | | 10.82 - 84 | CD17 | 4 | █ | Y-117RS | 2930 | | | |
| Terano 2 R20 | 3.0 | 113 | 05.02 - | ZD30DDTI | 6 | █ | CZ71 | 6836 | | | |
| | | | | only if NGK is OE | | | | | | | |
| Terrano 1 | 2.0 | | | Z20S | 4 | 0,8 | BPR6ES | 7822 | 2 | LPG 2 | 1497 |
| Terrano 1 | 2.5 | | - 95 | TD25 | 4 | █ | Y-707RS | 4937 | | | |
| Terrano 1 | 2.7 | | - 95 | TD27 | 4 | █ | Y-707RS | 4937 | | | |
| Terrano 1 WD/WHYD21 | 3.0 | 109 | 01.90 - 07.96 | VG30E Cat. | 6 | 0,9 | BKR6EY | 3696 | | LPG 1 | 1496 |
| Terrano 1 WD21 | 2.4 | 76 | 08.87 - 07.92 | Z24i Cat. | 6 | 0,9 | BPR5ES | 7422 | 6 | LPG 2 | 1497 |
| Terrano 1 WYD21 | 3.0 | 95 | 08.88 - 90 | VG30i | 6 | 1,1 | BCPR5ES-11 | 3524 | | LPG 3 | 1498 |
| Terrano 1 4 x EX + 4 x IN | 2.4 | 76 | 08.86 - 92 | Z24i Twin Spark | 4 | 0,9 | BPR5ES | 7422 | 6 | LPG 3 * 8 pieces | 1497 |
| Terrano 2 R20 | 2.4 | 86 | 05.96 - 01 | KA24E | 6 | 1,1 | ZFR5E-11 | 4435 | | | |
| Terrano 2 R20 | 2.4 | 87 | 05.96 - 01 | KA24E | 6 | 1,1 | ZFR5E-11 | 4435 | | | |
| Terrano 2 R20 | 2.4 | 91 | 07.93 - 96 | KA24E | 6 | 1,1 | ZFR5E-11 | 4435 | | | |
| Terrano 2 not Europe | 2.7 | | 07.93 - 02 | TD27T | 4 | █ | Y-712RS | 6140 | | | |
| Terrano 2 Tdi R20 only Europa | 2.7 | 92 | 05.96 - 02 | TD27T For EU | 4 | █ | CY58 | 5486 | | | |
| Tiida 1.6 | 1.6 | 81 | 01.08 - | HR16DE | 4 | 1,1 | PLZKAR6A-11 | 5118 | | PLZKAR6A-11 | 5118 |
| Tiida 1.8 | 1.8 | 93 | 01.08 - | MR18DE | 4 | 1,1 | PLZKAR6A-11 | 5118 | | PLZKAR6A-11 | 5118 |
| Tino 1.8 16V V10 | 1.8 | 88 | 99 - | NEOQG18DE | 4 | 1,1 | BKR5E-11 | 6953 | 33 | LPG 1 | 1496 |
| Tino 2.0 16V V10 | 2.0 | 99 | 99 - | SR20DE | 4 | 1,1 | PFR6G-11 | 5555 | | PFR7G | 4364 |
| Tino 2.0 16V V10 | 2.2 | 84 | 07.00 - | YD22DT | 4 | █ | Y-519J | 2500 | | D-POWER 61 | 93293 |



l kW



Cyl.

Order-
No. No.LPG/CNG
D-PowerOrder-
No.**NISSAN**

| | | | | | | | | | | | |
|------------------------------------|-----|-----|---------------|-------------|---|-----------------|------|----|-------------|-------|--|
| Trade JX1100 | 2.0 | | 03.85 - | LD20 | 4 | Y-204RS | 4573 | | | | |
| Trade PF1104 | 2.0 | 46 | 10.87 - | LD20IIE | 4 | Y-918J | 6285 | | D-POWER 2 | 6285 | |
| Urvan E23 | 1.8 | | 04.82 - 02.87 | Z18 | 4 | 0,9 BPR5ES | 7422 | 6 | LPG 2 | 1497 | |
| Urvan E23 | 2.0 | 55 | 07.80 - 04.82 | H20 | 4 | 0,8 BPR6ES | 7822 | 2 | LPG 2 | 1497 | |
| Urvan E23 | 2.0 | 64 | 04.82 - 02.87 | Z20 | 4 | 0,8 BPR6ES | 7822 | 2 | LPG 2 | 1497 | |
| Urvan E24 | 2.0 | 64 | 11.86 - 97 | Z20 OHC | 4 | 0,9 BPR5ES | 7422 | 6 | LPG 2 | 1497 | |
| Urvan E24 | 2.0 | | 95 - 97 | NA20S | 4 | 1,1 BPR6ES-11 | 4824 | 13 | LPG 2 | 1497 | |
| Urvan E24 | 2.4 | 74 | 05.89 - 96 | Z24i | 6 | 0,9 BPR5ES | 7422 | 6 | LPG 2 | 1497 | |
| Urvan E24 | 2.4 | 74 | 02.87 - 97 | Z24S OHC | 6 | 0,9 BPR5ES | 7422 | 6 | LPG 2 | 1497 | |
| Urvan E24 | 2.4 | | 95 - 97 | Z24 | 6 | 0,7 BP6ES | 7811 | 4 | LPG 2 | 1497 | |
| Urvan E24L | 2.5 | | 93 - 97 | TD25 | 4 | Y-707RS | 4937 | | | | |
| Urvan QGS Type 2 | 2.0 | | 05.82 - 98 | LD20T | 4 | Y-204SS | 7629 | | | | |
| Urvan QGS Type 2 | 2.3 | | 05.82 - | SD23 | 4 | Y-112M1 | 2531 | | | | |
| Urvan / E20 / E23 / E24 | 2.2 | | 09.80 - 97 | SD22 | 4 | Y-181T | 2728 | | | | |
| Urvan / E20 / E23 / E24 | 2.2 | | 09.80 - 97 | SD22 | 4 | Y-112T | 6327 | | | | |
| Urvan / E20 / E23 / E24 | 2.3 | | 05.82 - 97 | SD23 | 4 | Y-162R1 | 2431 | | | | |
| Urvan / E20 / E23 / E24 | 2.3 | | - 97 | TD23 | 4 | Y-707RS | 4937 | | | | |
| Urvan / E20 / E23 / E24 | 2.7 | | 87 - 97 | TD27 | 4 | Y-707RS | 4937 | | | | |
| Urvan / E20 / E23 / E24 QGS Type 1 | 2.0 | | 05.82 - 97 | LD20T | 4 | Y-204RS | 4573 | | | | |
| Urvan / E20 / E23 / E24 QGS Type 1 | 2.3 | | 05.82 - 97 | SD23 | 4 | Y-112R1 | 1032 | | | | |
| Vanette | 2.0 | | | CD20 | 4 | CY52 | 3017 | | | | |
| Vanette | 2.0 | | 06.81 - 09.82 | LD20 | 4 | Y-204TS-1 | 3829 | | | | |
| Vanette | 2.0 | | 93 - | SR20E | 4 | 0,9 BKR5EY | 7390 | | LPG 1 | 1496 | |
| Vanette | 2.3 | 55 | 05.98 - | LD23 | 4 | Y-530J | 6586 | | | | |
| Vanette C220 | 2.0 | 44 | 04.87 - 11.94 | LD20 II OHV | 4 | CY51 | 2696 | | | | |
| Vanette C220 | 2.0 | 47 | 01.91 - 11.94 | LD20 IIL | 4 | CY51 | 2696 | | | | |
| Vanette GC22 | 2.0 | 47 | 09.86 - 03.93 | LD20 OHV | 4 | CY51 | 2696 | | | | |
| Vanette C120 | 1.4 | 43 | 11.80 - 05.81 | A14 | 4 | 0,9 BPR5ES | 7422 | 6 | LPG 2 | 1497 | |
| Vanette C120 | 1.5 | 51 | 06.81 - 09.86 | A15 | 4 | 0,9 BPR5ES | 7422 | 6 | LPG 2 | 1497 | |
| Vanette C22 | 2.4 | 74 | 09.86 - 93 | Z24i | 4 | 0,9 BPR5ES | 7422 | 6 | LPG 2 | 1497 | |
| Vanette GC22 | 1.5 | 51 | 09.86 - 95 | A15S | 4 | 0,9 BPR5ES | 7422 | 6 | LPG 2 | 1497 | |
| Vanette GC22 | 2.0 | 64 | 09.86 - 95 | Z20S | 4 | 0,8 BPR6ES | 7822 | 2 | LPG 2 | 1497 | |
| Vanette M20 | 1.6 | | 09 - | HR16DE | 4 | 1,1 LZKAR6AP-11 | 6643 | | LZKAR6AP-11 | 6643 | |
| Vanette Cargo | 2.0 | 49 | 07.92 - 09.94 | LD20 OHV | 4 | CY51 | 2696 | | | | |
| Vanette QGS Type 1 | 2.0 | | 09.82 - 86 | LD20 | 4 | Y-204RS | 4573 | | | | |
| Vanette QGS Type 2 | 2.0 | | 09.82 - 86 | LD20 | 4 | Y-204SS | 7629 | | | | |
| Vanette Cargo (NL) | 1.6 | 71 | 03.95 - | | 4 | 0,8 BKR5E | 7938 | 35 | LPG 1 | 1496 | |
| Vanette E (NL) | 1.6 | 71 | 03.95 - | | 4 | 0,8 BKR5E | 7938 | 35 | LPG 1 | 1496 | |
| X-Trail T30 | 2.0 | 103 | 06.01 - | QR20DE | 4 | 1,1 LFR5A-11 | 6376 | | LPG 7 | 1640 | |
| X-Trail T30 | 2.0 | | 02.01 - | SR20VET | 4 | 0,9 PLFR6A-9 | 4342 | | LPG 7 | 1640 | |
| X-Trail T30 | 2.2 | 84 | 09.01 - 10.03 | YD22DDTi | 4 | Y-519J | 2500 | | D-POWER 61 | 93293 | |
| X-Trail T30 | 2.5 | 121 | 03 - | QR25DE | 4 | 1,1 LFR5A-11 | 6376 | | LPG 7 | 1640 | |
| X-Trail T30 dCi | 2.2 | 100 | 11.03 - | YD22DDTi | 4 | Y-519J | 2500 | | D-POWER 61 | 93293 | |
| X-Trail T31 | 2.5 | 124 | 06.07 - | QR25DE | 4 | 1,1 DILKAR6A11 | 9029 | | DILKAR6A11 | 9029 | |

NISSAN (Spain)

| | | | | | | | | | | | |
|---------------|-----|----|---------------|--------|---|--------|------|--|-----------|------|--|
| L 35 D | 2.9 | 56 | 05.85 - | | 6 | Y-924J | 7906 | | D-POWER 1 | 7906 | |
| Mot. A 4.28 D | 2.8 | 62 | 09.87 - 05.93 | A 4.28 | 4 | Y-924J | 7906 | | D-POWER 1 | 7906 | |
| Patrol | | | -03.88 | | | Y-924J | 7906 | | D-POWER 1 | 7906 | |
| Patrol D | 2.8 | 62 | 09.87 - | A 4.28 | 4 | Y-924J | 7906 | | D-POWER 1 | 7906 | |
| Trade D | 2.8 | 62 | 09.87 - | A 4.28 | 4 | Y-924J | 7906 | | D-POWER 1 | 7906 | |



ℓ kW



Cyl.

Order-
No.VLINE
No.LPG/CNG
D-PowerOrder-
No.**OLDSMOBILE**

| | | | | | | | | | | | | |
|----------|-----|--|---------|----------------|---|-----|----------|------|--|-------|------|--|
| 98 | 4.1 | | 81 - | 4 4 bbl CID252 | 6 | 2,0 | UR40 | 4386 | | | | |
| 98 | 4.1 | | 82 - | 4 4 bbl CID252 | 6 | 1,5 | UR45 | 2451 | | UR5IX | 7177 | |
| 98 | 5.0 | | 80 - 82 | Y 4 bbl CID307 | 8 | 1,5 | XR40 | 2990 | | | | |
| 98 | 5.7 | | 80 - | R 4 bbl CID350 | 8 | 1,5 | XR40 | 2990 | | | | |
| Delta 88 | 3.8 | | 95 - 95 | V6 MFI 1 SC | 6 | 1,5 | TR55 | 1048 | | LPG 5 | 1516 | |
| Delta 88 | 3.8 | | 95 - 95 | V6 MFI K | 6 | 1,5 | TR55 | 1048 | | LPG 5 | 1516 | |
| Delta 88 | 3.8 | | 96 - 99 | V6 MFI K | 6 | 1,5 | PTR4B-15 | 5146 | | LPG 5 | 1516 | |
| Delta 88 | 3.8 | | 94 - 94 | V6 SFI L | 6 | 1,5 | TR55 | 1048 | | LPG 5 | 1516 | |
| Intrigue | 3.5 | | 99 - | V6 MFI H | 6 | 1,5 | TR55 | 1048 | | LPG 5 | 1516 | |
| Intrigue | 3.8 | | 98 - 99 | V6 MFI K | 6 | 1,5 | PTR4B-15 | 5146 | | LPG 5 | 1516 | |
| LSS | 3.8 | | 96 - 99 | V6 MFI 1 SC | 6 | 1,5 | PTR4B-15 | 5146 | | LPG 5 | 1516 | |
| LSS | 3.8 | | 96 - 99 | V6 MFI K | 6 | 1,5 | PTR4B-15 | 5146 | | LPG 5 | 1516 | |
| Toronado | 3.8 | | 80 - | A 2 bbl CID231 | 6 | 1,5 | UR45 | 2451 | | UR5IX | 7177 | |
| Toronado | 4.1 | | 81 - 83 | 4 4 bbl CID252 | 6 | 2,0 | UR40 | 4386 | | | | |
| Toronado | 4.1 | | 82 - | 4 4 bbl CID252 | 6 | 1,5 | UR45 | 2451 | | UR5IX | 7177 | |
| Toronado | 4.3 | | 80 - | F 2 bbl CID260 | 8 | 1,5 | XR40 | 2990 | | | | |
| Toronado | 5.0 | | 80 - | H 4 bbl CID305 | 8 | 1,1 | UR4 | 4762 | | UR5IX | 7177 | |
| Toronado | 5.0 | | 80 - 83 | Y 4 bbl CID307 | 8 | 1,5 | XR40 | 2990 | | | | |
| Toronado | 5.7 | | 80 - | R 4 bbl CID350 | 8 | 1,5 | XR40 | 2990 | | | | |

OPEL

| | | | | | | | | | | | | |
|----------------|-----|-----|-------------|--------------|---|-----|-----------|-------|----|------------|-------|--|
| Agila 1.3 CDTI | 1.3 | 51 | 08.03 - | Z13DT | 4 | █ | Y8003J | 97256 | | D-POWER 62 | 97256 | |
| Agila 12V | 1.0 | 43 | 07.00 - | Z10XE | 3 | | BKR5EK | 7956 | 23 | LPG 1 | 1496 | |
| Agila 12V | 1.0 | 44 | 04 - | Z10XEP | 3 | 1,1 | ZFR5F-11 | 2262 | | LPG 6 | 1565 | |
| Agila 16V | 1.2 | 55 | 07.00 - | Z12XE | 4 | | BKR5EK | 7956 | 23 | LPG 1 | 1496 | |
| Agila 16V | 1.2 | 59 | 07.04 - | Z12XEP | 4 | 1,1 | ZFR5F-11 | 2262 | | LPG 6 | 1565 | |
| Antara 2.4 | 2.4 | 103 | 09.06 - | Z24XED | 4 | | BKR5EK | 7956 | 23 | LPG 1 | 1496 | |
| Antara 3.2 | 3.2 | 167 | 09.06 - | Z32SE | 6 | 1,3 | PTR5A-13 | 2467 | 25 | LPG 4 | 1511 | |
| Arena 1.9D | 1.9 | 44 | 01.98 - | F8Q M6 | 4 | █ | Y-506R | 4409 | | D-POWER 7 | 2419 | |
| Arena 2.5D | 2.5 | 55 | 07.98-02.01 | S8U V7 | 4 | █ | Y-908R | 4585 | | D-POWER 1 | 7906 | |
| Ascona B | 1.6 | 51 | 09.81-08.88 | 16N OHC II | 4 | 0,8 | BPR6ES | 7822 | 2 | LPG 2 | 1497 | |
| Ascona B | 2.4 | 106 | 07.80-08.81 | 24E CIH | 4 | 0,8 | BP6EFS | 3812 | 5 | LPG 5 | 1516 | |
| Ascona C | 1.6 | 40 | 03.82-09.88 | 16 D, DA OHC | 4 | █ | Y-924U | 4950 | | D-POWER 1 | 7906 | |
| Ascona C | 1.6 | 55 | 09.86-09.87 | C16LZ OHC I | 4 | 1,1 | BPR6ES-11 | 4824 | 13 | LPG 2 | 1497 | |
| Ascona C | 1.6 | 55 | 09.87-08.88 | C16NZ | 4 | 0,9 | BPR5ES | 7422 | 6 | LPG 2 | 1497 | |
| Ascona C | 1.6 | 55 | 09.87-09.88 | E16NZ OHC | 4 | 0,8 | BPR6ES | 7822 | 2 | LPG 2 | 1497 | |
| Ascona C | 1.6 | 60 | 09.81-08.88 | 16SH OHC | 4 | 0,8 | BPR6ES | 7822 | 2 | LPG 2 | 1497 | |
| Ascona C | 1.6 | 60 | 09.81-09.88 | 16SV OHC | 4 | 0,8 | BPR6ES | 7822 | 2 | LPG 2 | 1497 | |
| Ascona C | 1.6 | | - 83 | | 4 | █ | Y-924J | 7906 | | D-POWER 1 | 7906 | |
| Ascona C | 1.8 | 62 | 09.87-09.88 | E18NV OHC II | 4 | 0,8 | BPR6ES | 7822 | 2 | LPG 2 | 1497 | |
| Ascona C | 1.8 | 74 | 09.82-09.86 | 18E OHC II | 4 | 0,8 | BPR6ES | 7822 | 2 | LPG 2 | 1497 | |
| Ascona C | 1.8 | 74 | 01.85-08.86 | C18NE OHC II | 4 | 0,8 | BPR6ES | 7822 | 2 | LPG 2 | 1497 | |
| Ascona C | 1.8 | 74 | 09.82-09.86 | C18NE OHC II | 4 | 0,8 | BPR6ES | 7822 | 2 | LPG 2 | 1497 | |
| Ascona C | 1.8 | 82 | 09.86-09.88 | 18SE OHC II | 4 | 0,8 | BPR6ES | 7822 | 2 | LPG 2 | 1497 | |
| Ascona C | 1.8 | 85 | 09.82-08.86 | 18E OHC II | 4 | 0,8 | BPR6ES | 7822 | 2 | LPG 2 | 1497 | |
| Ascona C | 2.0 | 85 | 09.86-09.88 | 20NE | 4 | 0,9 | BPR5ES | 7422 | 6 | LPG 2 | 1497 | |
| Ascona C | 2.0 | 85 | 09.86-09.88 | C20NE OHC | 4 | 0,9 | BPR5ES | 7422 | 6 | LPG 2 | 1497 | |
| Ascona C | 2.0 | 95 | 03.87-09.88 | 20SEH OHC II | 4 | 0,8 | BPR6ES | 7822 | 2 | LPG 2 | 1497 | |
| Astra F | 1.4 | 44 | 09.91-07.95 | C14NZ OHC 1 | 4 | 0,9 | BPR5ES | 7422 | 6 | LPG 2 | 1497 | |
| Astra F | 1.4 | 44 | 08.95-02.98 | C14NZ OHC I | 4 | | BKR5EK | 7956 | 23 | LPG 1 | 1496 | |
| Astra F | 1.4 | 44 | 08.96-02.98 | X14NZ OHC I | 4 | | BKR5EK | 7956 | 23 | LPG 1 | 1496 | |
| Astra F | 1.4 | 55 | 09.91-03.93 | 14NV OHC 1 | 4 | | BKR5EK | 7956 | 23 | LPG 1 | 1496 | |



ℓ kW



Cyl.

Order-
No. No.LPG/CNG
D-PowerOrder-
No.**OPEL**

| | | | | | | | | | | | |
|--------------------|-----|-----|---------------|--------------------|---|-----|-----------|------|----|------------|------|
| Astra F | 1.4 | 60 | 03.93 - 07.95 | 14SE OHC | 4 | 0,9 | BPR5ES | 7422 | 6 | LPG 2 | 1497 |
| Astra F | 1.4 | 60 | 08.95 - 02.98 | 14SE OHC | 4 | | BKR5EK | 7956 | 23 | LPG 1 | 1496 |
| Astra F | 1.4 | 60 | 08.95 - 02.98 | C14SE OHC | 4 | | BKR5EK | 7956 | 23 | LPG 1 | 1496 |
| Astra F | 1.4 | 60 | 09.91 - 07.95 | C14SE OHC | 4 | 0,9 | BPR5ES | 7422 | 6 | LPG 2 | 1497 |
| Astra F | 1.4 | 66 | 02.96 - 02.98 | X14XE DOHC | 4 | | BKR5EK | 7956 | 23 | LPG 1 | 1496 |
| Astra F | 1.6 | 52 | 01.95 - 02.96 | X16SZ OHC | 4 | | BKR5EK | 7956 | 23 | LPG 1 | 1496 |
| Astra F | 1.6 | 52 | 03.93 - 03.94 | X16SZ OHC | 4 | 0,9 | BPR5ES | 7422 | 6 | LPG 2 | 1497 |
| Astra F | 1.6 | 52 | 04.94 - 12.94 | X16SZ OHC | 4 | 0,9 | BPR5ES | 7422 | 6 | LPG 2 | 1497 |
| Astra F | 1.6 | 55 | 08.94 - 02.98 | 16LZ2 OHC | 4 | | BKR5EK | 7956 | 23 | LPG 1 | 1496 |
| Astra F | 1.6 | 55 | 09.97 - | 16NZR OHC | 4 | | BKR5EK | 7956 | 23 | LPG 1 | 1496 |
| Astra F | 1.6 | 55 | 08.95 - 02.96 | C16NZ OHC | 4 | | BKR5EK | 7956 | 23 | LPG 1 | 1496 |
| Astra F | 1.6 | 55 | 09.91 - 07.95 | C16NZ OHC | 4 | 0,9 | BPR5ES | 7422 | 6 | LPG 2 | 1497 |
| Astra F | 1.6 | 55 | 02.96 - 08.00 | X16SZR OHC | 4 | | BKR5EK | 7956 | 23 | LPG 1 | 1496 |
| Astra F | 1.6 | 74 | 02.92 - 07.95 | C16SE OHC I | 4 | 0,9 | BPR5ES | 7422 | 6 | LPG 2 | 1497 |
| Astra F | 1.6 | 74 | 08.95 - 02.98 | C16SE OHC I | 4 | | BKR5EK | 7956 | 23 | LPG 1 | 1496 |
| Astra F | 1.6 | 74 | 08.94 - 02.98 | X16XEL DOHC | 4 | | BKR5EK | 7956 | 23 | LPG 1 | 1496 |
| Astra F | 1.7 | 42 | 09.91 - 09.92 | 17 D OHC II | 4 | ■ | Y-924U | 4950 | | D-POWER 1 | 7906 |
| Astra F | 1.7 | 44 | 09.92 - 08.94 | 17 DR | 4 | ■ | Y-924U | 4950 | | D-POWER 1 | 7906 |
| Astra F | 1.8 | 66 | 08.95 - 02.98 | C18NZ OHC II | 4 | | BKR5EK | 7956 | 23 | LPG 1 | 1496 |
| Astra F | 1.8 | 66 | 09.91 - 07.95 | C18NZ OHC II | 4 | 0,9 | BPR5ES | 7422 | 6 | LPG 2 | 1497 |
| Astra F | 2.0 | 85 | 08.95 - 02.98 | C20NE OHC II | 4 | | BKR5EK | 7956 | 23 | LPG 1 | 1496 |
| Astra F | 2.0 | 85 | 09.91 - 07.95 | C20NE OHC II | 4 | 0,9 | BPR5ES | 7422 | 6 | LPG 2 | 1497 |
| Astra F Eco D | 1.7 | 50 | 08.94 - 02.98 | X17 DTL | 4 | ■ | Y-924U | 4950 | | D-POWER 1 | 7906 |
| Astra F TD | 1.7 | 60 | 12.91 - 02.98 | 17DT TC4 EE1 OHC | 4 | ■ | CY03 | 6160 | | D-POWER 8 | 6160 |
| | | | | Isuzu Mot.956633—> | | | | | | | |
| Astra F TD | 1.7 | 60 | 04.96 - 02.98 | X17DT TC4 EE1 OHC | 4 | ■ | CY03 | 6160 | | D-POWER 8 | 6160 |
| | | | | Isuzu Mot.956633—> | | | | | | | |
| Astra F 16V | 1.8 | 85 | 02.94 - 03.96 | C18XEL DOHC | 4 | | BKR5EK | 7956 | 23 | LPG 1 | 1496 |
| Astra F 16V | 1.8 | 85 | 02.96 - 02.98 | X18XE DOHC | 4 | | BKR5EK | 7956 | 23 | LPG 1 | 1496 |
| Astra F 16V | 1.8 | 92 | 05.93 - 04.94 | C18XE DOHC II | 4 | | BKR5EK | 7956 | 23 | LPG 1 | 1496 |
| Astra F 16V | 2.0 | 100 | 02.95 - 02.98 | X20XEV DOHC | 4 | | BKR5EK | 7956 | 23 | LPG 1 | 1496 |
| Astra F 16V | 2.0 | 110 | 09.91 - 08.92 | C20XE DOHC | 4 | | BKR6EK | 2288 | 20 | LPG 1 | 1496 |
| Astra F 16V | 2.0 | 110 | 09.92 - 02.98 | C20XE DOHC | 4 | | BKR5EK | 7956 | 23 | LPG 1 | 1496 |
| Astra F 16V | 2.0 | 110 | 09.91 - 08.92 | C20XE-LN DOHC I | 4 | | BKR6EK | 2288 | 20 | LPG 1 | 1496 |
| Astra F 16V | 2.0 | 110 | 09.92 - 02.98 | C20XE-LN DOHC I | 4 | | BKR5EK | 7956 | 23 | LPG 1 | 1496 |
| Astra G | 1.2 | 55 | 08.00 - | Z12XE | 4 | | BKR5EK | 7956 | 23 | LPG 1 | 1496 |
| Astra G | 1.4 | 66 | 08.00 - | Z14XE DOHC | 4 | | BKR5EK | 7956 | 23 | LPG 1 | 1496 |
| Astra G | 1.6 | 62 | 08.00 - | Z16SE | 4 | | BKR5EK | 7956 | 23 | LPG 1 | 1496 |
| Astra G | 1.6 | 71 | 09.02 - 06.04 | Z16YNG | 4 | | LPG 1 | 1496 | | LPG 1 | 1496 |
| Astra G | 1.6 | 74 | 03.03 - | Z16XEP | 4 | 1,1 | ZFR5F-11 | 2262 | | LPG 6 | 1565 |
| Astra G | 1.8 | 85 | 08.00 - | Z18XEL | 4 | | BKR5EQUPA | 3566 | | | |
| Astra G | 2.2 | 92 | 03 - | Y22DTR | 4 | ■ | Y-523J | 6298 | | D-POWER 37 | 6298 |
| Astra G | 2.2 | 108 | 09.00 - 06 | Z22SE | 4 | | LTR6B-10T | 5948 | | LTR6B-10T | 5948 |
| Astra G D | 1.7 | 50 | 02.98 - | X17DTL | 4 | ■ | Y-924U | 4950 | | D-POWER 1 | 7906 |
| Astra G DTI 16V | 1.7 | 55 | 02.00 - 01.05 | Y17DT | 4 | ■ | Y-541J | 1983 | | D-POWER 42 | 1983 |
| Astra G DTI 16V | 2.0 | 60 | 02.98 - | X20DTL SOHC | 4 | ■ | Y-748U | 6649 | | D-POWER 14 | 6649 |
| Astra G DTI II | 2.0 | 60 | 08.00 - | Y20DTL | 4 | ■ | Y-748U | 6649 | | D-POWER 14 | 6649 |
| Astra G DTI II 16V | 2.0 | 74 | 08.00 - | Y20DTH | 4 | ■ | Y-523J | 6298 | | D-POWER 37 | 6298 |
| Astra G GTC Turbo | 2.0 | 147 | 11.02 - 05.05 | Z20LER | 4 | 0,7 | ZFR5F | 5165 | | LPG 6 | 1565 |
| Astra G 16V | 1.2 | 48 | 03.98 - 00 | X12XE DOHC | 4 | | BKR5EK | 7956 | 23 | LPG 1 | 1496 |
| Astra G 16V | 1.4 | 66 | 03.98 - | X14XE DOHC | 4 | | BKR5EK | 7956 | 23 | LPG 1 | 1496 |
| Astra G 16V | 1.6 | 55 | 03.98 - 08.00 | X16SZR | 4 | | BKR5EK | 7956 | 23 | LPG 1 | 1496 |



ℓ kW

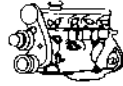

Cyl.

Order-
No.VLINE
No.LPG/CNG
D-PowerOrder-
No.**OPEL**

| | | | | | | | | | | | |
|-------------------|-----|-----|-------------|-------------------|---|-----|-----------|-------|----|------------|-------|
| Astra G 16V | 1.6 | 74 | 03.98 - | X16XEL | 4 | | BKR5EK | 7956 | 23 | LPG 1 | 1496 |
| Astra G 16V | 1.6 | 74 | 08.00 - | Z16XE | 4 | | BKR5EK | 7956 | 23 | LPG 1 | 1496 |
| Astra G 16V | 1.8 | 85 | 03.98 - | X18XE1 | 4 | | BKR5EK | 7956 | 23 | LPG 1 | 1496 |
| Astra G 16V | 1.8 | 92 | 08.00 - | Z18XE | 4 | | BKR5EK | 7956 | 23 | LPG 1 | 1496 |
| Astra G 16V | 2.0 | 100 | 03.98 - | X20XEV | 4 | | BKR5EK | 7956 | 23 | LPG 1 | 1496 |
| Astra G 16V | 2.0 | 118 | 10.99-09.02 | X20XER DOHC | 4 | | BKR5EK | 7956 | 23 | LPG 1 | 1496 |
| Astra G 16V | 2.2 | 108 | 01.99 - | X22XE DOHC | 4 | | BKR5EK | 7956 | 23 | LPG 1 | 1496 |
| Astra G 16V Turbo | 2.0 | 140 | 09.00 - | Z20LET | 4 | | BKR5EK | 7956 | 23 | LPG 1 | 1496 |
| Astra G CDTI | 1.7 | 59 | 04.03-01.05 | Z17DTL | 4 | █ | Y-541J | 1983 | | D-POWER 42 | 1983 |
| Astra H | 1.4 | 55 | 03.04 - | Z14XEL | 4 | 1,1 | ZFR5F-11 | 2262 | | LPG 6 | 1565 |
| Astra H | 1.4 | 66 | 03.04 - | Z14XEP | 4 | 1,1 | ZFR5F-11 | 2262 | | LPG 6 | 1565 |
| Astra H | 1.6 | 71 | 08.06 - | Z16YNG | 4 | | LPG 1 | 1496 | | LPG 1 | 1496 |
| Astra H | 1.6 | 74 | 03.04 - | Z16XEP | 4 | 1,1 | ZFR5F-11 | 2262 | | LPG 6 | 1565 |
| Astra H | 1.6 | 85 | 01.07 - | Z16XER | 4 | 1,1 | ZFR5F-11 | 2262 | | LPG 6 | 1565 |
| Astra H | 1.8 | 92 | 03.04 - | Z18XE | 4 | 1,1 | ZFR5F-11 | 2262 | | LPG 6 | 1565 |
| Astra H | 1.8 | 103 | 05.06 - | Z18XER | 4 | 1,1 | ZFR5F-11 | 2262 | | LPG 6 | 1565 |
| Astra H Turbo | 2.0 | 125 | 03.04 - | Z20LEL | 4 | 0,7 | ZFR5F | 5165 | | LPG 6 | 1565 |
| Astra H GTC Turbo | 1.6 | 132 | 03.07 - | Z16LET | 4 | | PFR6T-10G | 5542 | | PFR6T-10G | 5542 |
| Astra H GTC Turbo | 2.0 | 147 | 03.05 - | Z20LER | 4 | 0,7 | ZFR5F | 5165 | | LPG 6 | 1565 |
| Astra H OPC Turbo | 2.0 | 177 | 09.05 - | Z20LEH | 4 | | PFR6T-G | 6314 | | PFR6T-G | 6314 |
| Astra H CDTI | 1.3 | 66 | 06.04 - | Z13DTH | 4 | █ | Y8003J | 97256 | | D-POWER 62 | 97256 |
| Astra H CDTI | 1.7 | 59 | 03.04 - | Z17DTL | 4 | █ | Y-541J | 1983 | | D-POWER 42 | 1983 |
| Astra H CDTI | 1.7 | 74 | 03.04 - | Z17DTH | 4 | █ | Y-541J | 1983 | | D-POWER 42 | 1983 |
| Astra H CDTI | 1.7 | 92 | 02.07 - | A17DTR | 4 | █ | Y-541J | 1983 | | D-POWER 42 | 1983 |
| Astra H CDTI | 1.7 | 92 | 03.07 - | Z17DTR | 4 | █ | Y-541J | 1983 | | D-POWER 42 | 1983 |
| Astra H CDTI | 1.9 | 74 | 06.05 - | Z19DTL Fiat | 4 | █ | Y-534J | 3413 | | D-POWER 36 | 3413 |
| Astra H CDTI | 1.9 | 88 | 04.04 - | Z19DT Fiat | 4 | █ | Y-534J | 3413 | | D-POWER 36 | 3413 |
| Astra H CDTI | 1.9 | 88 | 04.05 - | Z19DTJ Fiat | 4 | █ | YE07 | 6092 | | | |
| Astra H CDTI 16V | 1.9 | 110 | 09.04 - | Z19DTH Fiat | 4 | █ | YE07 | 6092 | | | |
| Bedford Blitz D | | 46 | 09.80 - | | 4 | █ | Y-208T | 1250 | | | |
| Calibra | 2.0 | 85 | 06.90-07.95 | C20NE OHC II | 4 | 0,9 | BPR5ES | 7422 | 6 | LPG 2 | 1497 |
| Calibra | 2.0 | 85 | 08.95-08.97 | C20NE OHC II | 4 | | BKR5EK | 7956 | 23 | LPG 1 | 1496 |
| Calibra | 2.5 | 125 | 09.93-08.97 | C25XE DOHC | 6 | | BKR5EK | 7956 | 23 | LPG 1 | 1496 |
| Calibra | 2.5 | 125 | 09.93-08.97 | X25XE DOHC | 6 | | BKR5EK | 7956 | 23 | LPG 1 | 1496 |
| Calibra 16V | 2.0 | 100 | 11.93-08.97 | X20XEV DOHC | 4 | | BKR5EK | 7956 | 23 | LPG 1 | 1496 |
| Calibra 16V | 2.0 | 110 | 02.90-08.92 | C20XE | 4 | | BKR6EK | 2288 | 20 | LPG 1 | 1496 |
| Calibra 16V | 2.0 | 110 | 09.92-02.94 | C20XE | 4 | | BKR5EK | 7956 | 23 | LPG 1 | 1496 |
| Calibra 16V | 2.0 | 110 | 06.90-04.97 | C20XE-LN DOHC | 4 | | BKR6EK | 2288 | 20 | LPG 1 | 1496 |
| Calibra Turbo | 2.0 | 150 | 03.92-08.97 | C20LET DOHC | 4 | 1,1 | ZFR6F-11 | 4291 | | LPG 6 | 1565 |
| Campo | 2.3 | 66 | 11.88-09.91 | 4ZD1 | 4 | 0,8 | BPR6ES | 7822 | 2 | LPG 2 | 1497 |
| Campo | 2.3 | 72 | 08.94-08.95 | 4ZD1 | 4 | 0,8 | BPR6ES | 7822 | 2 | LPG 2 | 1497 |
| Campo TD | 2.5 | 56 | 07.94 - | 4JA1T (25 DT) | 4 | █ | Y-904M1 | 7995 | | | |
| Campo TDS | 3.1 | 80 | 09.92 - | 4JG2T (31 TD/TDS) | 4 | █ | Y-719RS1 | 6900 | | | |
| Combo | 1.4 | 44 | 03.93-10.01 | C14NZ OHC | 4 | | BKR5EK | 7956 | 23 | LPG 1 | 1496 |
| Combo | 1.4 | 44 | 02.96-10.01 | X14SZ OHC | 4 | | BKR5EK | 7956 | 23 | LPG 1 | 1496 |
| Combo | 1.4 | 60 | 03.93-10.01 | C14SE OHC | 4 | | BKR5EK | 7956 | 23 | LPG 1 | 1496 |
| Combo | 1.4 | 66 | 10.04 - | Z14XEP | 4 | 0,7 | ZFR5F | 5165 | | LPG 6 | 1565 |
| Combo | 1.6 | 64 | 10.01 - | Z16SE | 4 | | BKR5EK | 7956 | 23 | LPG 1 | 1496 |
| Combo | 1.7 | 44 | 07.94-10.01 | 17D 4EE1 OHC | 4 | █ | CY03 | 6160 | | D-POWER 8 | 6160 |
| Combo | 1.7 | 44 | 04.96-10.01 | X17D (4EE1)/OHC | 4 | █ | CY03 | 6160 | | D-POWER 8 | 6160 |
| Combo CNG | 1.6 | 69 | 05 - | Y16YNG | 4 | | LPG 1 | 1496 | | LPG 1 | 1496 |
| Combo CNG | 1.6 | 71 | 08.05 - | Z16YNG | 4 | | LPG 1 | 1496 | | LPG 1 | 1496 |



ℓ kW



Cyl.

Order-
No. No.LPG/CNG
D-PowerOrder-
No.**OPEL**

| | | | | | | | | | | | |
|-------------------------|-----|----|---------------|-----------------------------------|---|-----|--------|-------|----|------------|-------|
| Combo CDTI | 1.3 | 51 | 10.04 - | Y13DT | 4 | ▣ | Y8003J | 97256 | | D-POWER 62 | 97256 |
| Combo CDTI | 1.3 | 55 | 10.05 - | Y13DTJ | 4 | ▣ | Y8003J | 97256 | | D-POWER 62 | 97256 |
| Combo DI 16V | 1.7 | 48 | 10.01 - | Y17DTL | 4 | ▣ | Y-541J | 1983 | | D-POWER 42 | 1983 |
| Combo DTI 16V | 1.7 | 55 | 10.01 - | Y17DT | 4 | ▣ | Y-541J | 1983 | | D-POWER 42 | 1983 |
| Combo DTI 16V | 1.7 | 74 | 12.04 - | Z17DTH | 4 | ▣ | Y-541J | 1983 | | D-POWER 42 | 1983 |
| Commodore C | 2.5 | 96 | 05.81 - 12.82 | 25E CIH | 6 | 0,7 | BPR6HS | 7022 | 3 | BPR7HIX | 5944 |
| Corsa A | 1.0 | 33 | 09.82 - 09.92 | 10S OHV | 4 | 0,7 | BPR6HS | 7022 | 3 | BPR7HIX | 5944 |
| Corsa A | 1.2 | 33 | 03.85 - 03.87 | 12NC OHV | 4 | 0,7 | BPR6HS | 7022 | 3 | BPR7HIX | 5944 |
| Corsa A | 1.2 | 33 | 02.90 - 03.93 | 12NV OHC I | 4 | 0,8 | BPR6ES | 7822 | 2 | LPG 2 | 1497 |
| Corsa A | 1.2 | 33 | 09.90 - 03.93 | C12NZ OHC I | 4 | 0,9 | BPR5ES | 7422 | 6 | LPG 2 | 1497 |
| Corsa A | 1.2 | 33 | 03.87 - 06.90 | E12GV OHV | 4 | 0,7 | BPR6HS | 7022 | 3 | BPR7HIX | 5944 |
| Corsa A | 1.2 | 37 | 09.82 - 03.93 | 12S OHC | 4 | 0,8 | BPR6ES | 7822 | 2 | LPG 2 | 1497 |
| Corsa A | 1.2 | 37 | 09.86 - 03.93 | A12ST OHC | 4 | 0,8 | BPR6ES | 7822 | 2 | LPG 2 | 1497 |
| Corsa A | 1.2 | 40 | 09.82 - 02.90 | 12ST OHC | 4 | 0,8 | BPR6ES | 7822 | 2 | LPG 2 | 1497 |
| Corsa A | 1.2 | 40 | 09.84 - 03.93 | S12ST OHC | 4 | 0,8 | BPR6ES | 7822 | 2 | LPG 2 | 1497 |
| Corsa A | 1.3 | 44 | 03.86 - 10.89 | 13NB OHC | 4 | 0,8 | BPR6ES | 7822 | 2 | LPG 2 | 1497 |
| Corsa A | 1.3 | 44 | 09.85 - 10.89 | C13N OHC | 4 | 0,8 | BPR6ES | 7822 | 2 | LPG 2 | 1497 |
| Corsa A | 1.3 | 51 | 09.82 - 03.93 | 13S OHC | 4 | 0,8 | BPR6ES | 7822 | 2 | LPG 2 | 1497 |
| Corsa A | 1.3 | 52 | 09.82 - 10.89 | 13SB OHC | 4 | 0,8 | BPR6ES | 7822 | 2 | LPG 2 | 1497 |
| Corsa A | 1.4 | 44 | 10.89 - 03.93 | C14NZ OHC I | 4 | 0,9 | BPR5ES | 7422 | 6 | LPG 2 | 1497 |
| Corsa A | 1.4 | 53 | 10.89 - 09.92 | 14NV OHC I | 4 | 0,8 | BPR6ES | 7822 | 2 | LPG 2 | 1497 |
| Corsa A | 1.4 | 60 | 09.91 - 03.93 | C14SE OHC I | 4 | 0,9 | BPR5ES | 7422 | 6 | LPG 2 | 1497 |
| Corsa A | 1.6 | 55 | 03.88 - 09.91 | C16NZ | 4 | 0,9 | BPR5ES | 7422 | 6 | LPG 2 | 1497 |
| Corsa A | 1.6 | 74 | 02.92 - 03.93 | C16SE DOHC | 4 | 0,9 | BPR5ES | 7422 | 6 | LPG 2 | 1497 |
| Corsa A | 1.6 | 74 | 03.88 - 03.92 | E16SE OHC I | 4 | 0,8 | BPR6ES | 7822 | 2 | LPG 2 | 1497 |
| Corsa A D (Isuzu-Mot.) | 1.5 | 37 | 09.87 - 03.93 | 15 D/4 EC1 AAD → Motor 804 794 | 4 | ▣ | Y-306R | 6244 | | | |
| Corsa A D (Isuzu-Mot.) | 1.5 | 37 | 09.87 - 03.93 | 15 D/4 EC1 AAD Motor 804795 → | 4 | ▣ | Y-710J | 7880 | | | |
| Corsa A TD (Isuzu-Mot.) | 1.5 | 49 | 02.88 - 03.93 | 15DT/T4 EC1-AAADT OHC 804795→ | 4 | ▣ | Y-711J | 4467 | | D-POWER 28 | 4467 |
| Corsa A Irmscher | 1.6 | 72 | 06.90 - 03.92 | C16SEI irmscher | 4 | 0,8 | BPR6ES | 7822 | 2 | LPG 2 | 1497 |
| Corsa A Sprint | 1.3 | 61 | 04.85 - 03.93 | 13E irmscher | 4 | 0,8 | BPR6ES | 7822 | 2 | LPG 2 | 1497 |
| Corsa B | 1.2 | 33 | 03.93 - 07.95 | 12NZ | 4 | 0,9 | BPR5ES | 7422 | 6 | LPG 2 | 1497 |
| Corsa B | 1.2 | 33 | 08.95 - 12.97 | 12NZ | 4 | | BKR5EK | 7956 | 23 | LPG 1 | 1496 |
| Corsa B | 1.2 | 33 | 03.93 - 07.95 | C12NZ OHC I | 4 | 0,9 | BPR5ES | 7422 | 6 | LPG 2 | 1497 |
| Corsa B | 1.2 | 33 | 08.95 - 09.00 | C12NZ OHC I | 4 | | BKR5EK | 7956 | 23 | LPG 1 | 1496 |
| Corsa B | 1.2 | 33 | 03.93 - 07.95 | X12SZ OHC | 4 | 0,9 | BPR5ES | 7422 | 6 | LPG 2 | 1497 |
| Corsa B | 1.2 | 33 | 08.95 - 09.00 | X12SZ OHC | 4 | | BKR5EK | 7956 | 23 | LPG 1 | 1496 |
| Corsa B | 1.4 | 44 | 03.93 - 07.95 | C14NZ OHC I | 4 | 0,9 | BPR5ES | 7422 | 6 | LPG 2 | 1497 |
| Corsa B | 1.4 | 44 | 08.95 - 08.98 | C14NZ OHC I | 4 | | BKR5EK | 7956 | 23 | LPG 1 | 1496 |
| Corsa B | 1.4 | 44 | 03.96 - 07.00 | X14SZ | 4 | | BKR5EK | 7956 | 23 | LPG 1 | 1496 |
| Corsa B | 1.4 | 60 | 03.93 - 07.95 | C14SE OHC I | 4 | 0,9 | BPR5ES | 7422 | 6 | LPG 2 | 1497 |
| Corsa B | 1.4 | 60 | 08.95 - 07.97 | C14SE OHC I | 4 | | BKR5EK | 7956 | 23 | LPG 1 | 1496 |
| Corsa B | 1.4 | 63 | 06.98 - 10.00 | C14SEL OHC | 4 | | BKR5EK | 7956 | 23 | LPG 1 | 1496 |
| Corsa B | 1.5 | 49 | 04.96 - 08.01 | X15DT 4EE1 OHC | 4 | ▣ | CY03 | 6160 | | D-POWER 8 | 6160 |
| Corsa B | 1.6 | 74 | 06.98 - 10.00 | C16SEL DOHC | 4 | | BKR5EK | 7956 | 23 | LPG 1 | 1496 |
| Corsa B | 1.6 | 80 | 03.93 - 08.94 | C16XE DOHC I | 4 | | BKR5EK | 7956 | 23 | LPG 1 | 1496 |
| Corsa B D | 1.5 | 37 | 03.93 - 08.00 | 15D (4EC1) OHC Isuzu | 4 | ▣ | CY03 | 6160 | | D-POWER 8 | 6160 |
| Corsa B D | 1.7 | 44 | 04.96 - 08.01 | X17D (4EE1)/OHC | 4 | ▣ | CY03 | 6160 | | D-POWER 8 | 6160 |
| Corsa B TD | 1.5 | 49 | 03.93 - 08.00 | X/15DT (T4EC1) OHC Isuzu | 4 | ▣ | CY03 | 6160 | | D-POWER 8 | 6160 |
| Corsa B TD | 1.7 | 44 | 03.93 - 08.00 | 17D (4EE1)/OHC | 4 | ▣ | CY03 | 6160 | | D-POWER 8 | 6160 |



ℓ kW



Cyl.

Order-
No.VLINE
No.LPG/CNG
D-PowerOrder-
No.**OPEL**

| | | | | | | | | | | | |
|-------------------------------|-----|-----|---------------|--------------------------|---|-----|-----------|-------|----|------------|-------|
| Corsa B 12V | 1.0 | 40 | 03.97 - 08.00 | X10XE DOHC | 3 | | BKR5EK | 7956 | 23 | LPG 1 | 1496 |
| Corsa B 16V | 1.2 | 48 | 09.97 - 08.01 | X12XE | 4 | | BKR5EK | 7956 | 23 | LPG 1 | 1496 |
| Corsa B 16V | 1.4 | 66 | 11.94 - 08.00 | X14XE DOHC | 4 | | BKR5EK | 7956 | 23 | LPG 1 | 1496 |
| Corsa B 16V | 1.6 | 78 | 08.94 - 08.01 | X16XE DOHC | 4 | | BKR5EK | 7956 | 23 | LPG 1 | 1496 |
| Corsa C | 1.2 | 55 | 08.00 - | Z12XE | 4 | | BKR5EK | 7956 | 23 | LPG 1 | 1496 |
| Corsa C | 1.2 | 59 | 07.04 - | Z12XEP | 4 | 1,1 | ZFR5F-11 | 2262 | | LPG 6 | 1565 |
| Corsa C | 1.4 | 66 | 08.00 - | Z14XE | 4 | | BKR5EK | 7956 | 23 | LPG 1 | 1496 |
| Corsa C | 1.4 | 66 | 06.03 - | Z14XEP | 4 | 1,1 | ZFR5F-11 | 2262 | | LPG 6 | 1565 |
| Corsa C | 1.6 | 62 | 08.00 - | Z16SE | 4 | | BKR5EK | 7956 | 23 | LPG 1 | 1496 |
| Corsa C | 1.8 | 92 | 08.00 - | Z18XE | 4 | | BKR5EK | 7956 | 23 | LPG 1 | 1496 |
| Corsa C CDTI | 1.3 | 51 | 06.03 - | Z13DT | 4 | █ | Y8003J | 97256 | | D-POWER 62 | 97256 |
| Corsa C CDTI | 1.7 | 74 | 06.03 - | Z17DTH | 4 | █ | Y-541J | 1983 | | D-POWER 42 | 1983 |
| Corsa C 12V | 1.0 | 43 | 08.00 - | Z10XE | 3 | | BKR5EK | 7956 | 23 | LPG 1 | 1496 |
| Corsa C 12V | 1.0 | 44 | 06.03 - | Z10XEP | 3 | 1,1 | ZFR5F-11 | 2262 | | LPG 6 | 1565 |
| Corsa C CNG | 1.6 | 71 | 04 - | Y16YNG | 4 | | LPG 1 | 1496 | | LPG 1 | 1496 |
| Corsa C DI 16V | 1.7 | 48 | 08.00 - | Y17DTL | 4 | █ | Y-541J | 1983 | | D-POWER 42 | 1983 |
| Corsa C DTI 16V | 1.7 | 55 | 08.00 - | Y17DT | 4 | █ | Y-541J | 1983 | | D-POWER 42 | 1983 |
| Corsa D | 1.2 | 59 | 07.06 - | Z12XEP | 4 | 1,1 | ZFR5F-11 | 2262 | | LPG 6 | 1565 |
| Corsa D | 1.4 | 66 | 07.06 - | Z14XEP | 4 | 1,1 | ZFR5F-11 | 2262 | | LPG 6 | 1565 |
| Corsa D | 1.6 | 132 | 04.07 - | Z16LET | 4 | | PFR6T-10G | 5542 | | PFR6T-10G | 5542 |
| Corsa D CDTI | 1.3 | 66 | 07.05 - | Z13XDTH | 4 | █ | Y8003J | 97256 | | D-POWER 62 | 97256 |
| Corsa D CDTI | 1.7 | 92 | 07.06 - | Z17DTR | 4 | █ | Y-541J | 1983 | | D-POWER 42 | 1983 |
| Corsa D 12V | 1.0 | 44 | 07.06 - | Z10XEP | 3 | 1,1 | ZFR5F-11 | 2262 | | LPG 6 | 1565 |
| Corsa D DTI 16V | 1.3 | 55 | 07.06 - | Z13DTJ | 4 | █ | Y8003J | 97256 | | D-POWER 62 | 97256 |
| Corsa D OPC | 1.6 | 132 | 09 - | A16LET | 4 | | PFR6T-10G | 5542 | | PFR6T-10G | 5542 |
| Corsa D OPC | 1.6 | 141 | 08.07 - | Z16LER | 4 | | PFR6T-10G | 5542 | | PFR6T-10G | 5542 |
| Frontera | 2.0 | 85 | 09.91 - 08.95 | C20NE OHC II | 4 | | BKR5EK | 7956 | 23 | LPG 1 | 1496 |
| Frontera | 2.0 | 85 | 02.95 - 06.98 | X20SE OHC II | 4 | | BKR5EK | 7956 | 23 | LPG 1 | 1496 |
| Frontera | 2.0 | 85 | 02.95 - | X20XE OHC | 4 | | BKR5EK | 7956 | 23 | LPG 1 | 1496 |
| Frontera | 2.4 | 92 | 09.91 - 02.95 | C24NE CIH | 4 | 0,7 | BPR6HS | 7022 | 3 | BPR7HIX | 5944 |
| Frontera 16V | 2.2 | 100 | 02.95 - 06.98 | X22XE DOHC | 4 | | BKR5EK | 7956 | 23 | LPG 1 | 1496 |
| Frontera A 2,3 TD Intercooler | 2.3 | 74 | 09.91 - 02.95 | 23 DTR OHC | 4 | █ | Y-924U | 4950 | | D-POWER 1 | 7906 |
| Frontera A TD Intercool | 2.3 | 74 | 03.92 - 09.95 | DTR OHC | 4 | █ | Y-924U | 4950 | | D-POWER 1 | 7906 |
| Frontera A TDI | 2.5 | 85 | 06.96 - 08.98 | 25TD VM41B (25TDS) | 4 | █ | Y-741U | 6943 | | D-POWER 20 | 6943 |
| Frontera A TDI | 2.5 | 85 | 09.96 - 10.98 | 25TD/TDS/OHC | 4 | █ | Y-741U | 6943 | | D-POWER 20 | 6943 |
| Frontera A TDI | 2.8 | 83 | 02.95 - 11.98 | 28TD 4JB1T (28TDI) Isuzu | 4 | █ | Y-904M1 | 7995 | | | |
| Frontera B | 2.2 | 100 | 10.98 - 12.00 | X22SE | 4 | | BKR5EK | 7956 | 23 | LPG 1 | 1496 |
| Frontera B 16V | 2.2 | 100 | 10.98 - | X22XE DOHC | 4 | | BKR5EK | 7956 | 23 | LPG 1 | 1496 |
| Frontera B DTI 16V | 2.2 | 85 | 10.98 - 09.02 | X22DTH | 4 | █ | Y-748U | 6649 | | D-POWER 14 | 6649 |
| Frontera B DTI 16V | 2.2 | 85 | 10.98 - 09.02 | Y22DTH | 4 | █ | Y-523J | 6298 | | D-POWER 37 | 6298 |
| Frontera B V6 | 3.2 | 151 | 08.98 - | Y32NE 6VD1 | 6 | 1,1 | PFR5G-11 | 2647 | | PFR6G-11 | 5555 |
| GT Turbo | 2.0 | 194 | 11.07 - 01.10 | Z20LNF | 4 | 0,9 | ILTR5D | 5476 | | ILTR5D | 5476 |
| Insigna | 1.6 | 85 | 07.08 - | A16XER | 4 | 1,1 | ZFR5F-11 | 2262 | | LPG 6 | 1565 |
| Insigna | 1.8 | 103 | 07.08 - | A18XER | 4 | 1,1 | ZFR5F-11 | 2262 | | LPG 6 | 1565 |
| Insigna 1.6 Turbo | 1.6 | 132 | 09 - | A16LET | 4 | | PFR6T-10G | 5542 | | PFR6T-10G | 5542 |
| Insigna 2.0 Turbo | 2.0 | 162 | 07.08 - | A20NHT | 4 | 1,0 | PFR6D10G | 1632 | | | |
| Kadett | | | - 83 | | 4 | █ | Y-924J | 7906 | | D-POWER 1 | 7906 |
| Kadett D | 1.2 | 40 | 08.82 - 08.84 | 12ST OHC | 4 | 0,8 | BPR6ES | 7822 | 2 | LPG 2 | 1497 |
| Kadett D | 1.6 | 66 | 09.81 - 08.84 | 16SH OHC | 4 | 0,8 | BPR6ES | 7822 | 2 | LPG 2 | 1497 |
| Kadett D | 1.8 | 85 | 02.83 - 08.84 | 18E OHC | 4 | 0,8 | BPR6ES | 7822 | 2 | LPG 2 | 1497 |
| Kadett D D | 1.6 | 40 | 03.82 - 09.84 | 16D OHC | 4 | █ | Y-924U | 4950 | | D-POWER 1 | 7906 |
| Kadett E | 1.2 | 40 | 09.84 - 09.91 | 12S,SC OHV | 4 | 0,7 | BPR6HS | 7022 | 3 | BPR7HIX | 5944 |



ℓ kW



Cyl.

Order-
No. No.LPG/CNG
D-PowerOrder-
No.**OPEL**

| | | | | | | | | | | | |
|-------------------------|-----|-----|---------------|--------------------------------|---|-----|------------|-------|----|------------|-------|
| Kadett E | 1.2 | 40 | 09.84 - 08.88 | 12S,ST OHC | 4 | 0,8 | BPR6ES | 7822 | 2 | LPG 2 | 1497 |
| Kadett E | 1.3 | 44 | 03.86 - 10.89 | 13N,NB OHC | 4 | 0,8 | BPR6ES | 7822 | 2 | LPG 2 | 1497 |
| Kadett E | 1.3 | 44 | 09.85 - 10.89 | C13N OHC | 4 | 0,8 | BPR6ES | 7822 | 2 | LPG 2 | 1497 |
| Kadett E | 1.3 | 55 | 09.84 - 10.89 | 13S,SC OHC | 4 | 0,8 | BPR6ES | 7822 | 2 | LPG 2 | 1497 |
| Kadett E | 1.4 | 44 | 10.89 - 09.93 | 14NV OHC I | 4 | 0,8 | BPR6ES | 7822 | 2 | LPG 2 | 1497 |
| Kadett E | 1.4 | 44 | 10.89 - 09.91 | C14NZ OHC I | 4 | 0,9 | BPR5ES | 7422 | 6 | LPG 2 | 1497 |
| Kadett E | 1.4 | 44 | 01.90 - 08.91 | E14LV OHC I | 4 | 0,8 | BPR6ES | 7822 | 2 | LPG 2 | 1497 |
| Kadett E | 1.6 | 55 | 09.86 - 10.87 | C16LZ OHC I | 4 | 1,1 | BPR6ES-11 | 4824 | 13 | LPG 2 | 1497 |
| Kadett E | 1.6 | 55 | 09.87 - 09.93 | C16NZ OHC | 4 | 0,9 | BPR5ES | 7422 | 6 | LPG 2 | 1497 |
| Kadett E | 1.6 | 55 | 09.87 - 09.91 | E16NZ OHC | 4 | 0,8 | BPR6ES | 7822 | 2 | LPG 2 | 1497 |
| Kadett E | 1.6 | 55 | 09.87 - 08.91 | E16SE OHC | 4 | 0,8 | BPR6ES | 7822 | 2 | LPG 2 | 1497 |
| Kadett E | 1.6 | 60 | 09.86 - 09.91 | 16SV OHC I | 4 | 0,8 | BPR6ES | 7822 | 2 | LPG 2 | 1497 |
| Kadett E | 1.8 | 62 | 03.87 - 07.89 | E18NV OHC II | 4 | 0,8 | BPR6ES | 7822 | 2 | LPG 2 | 1497 |
| Kadett E | 1.8 | 62 | 09.86 - 08.91 | S18NV OHC II | 4 | 0,8 | BPR6ES | 7822 | 2 | LPG 2 | 1497 |
| Kadett E | 1.8 | 66 | 01.84 - 09.85 | C18NT OHC II | 4 | 0,8 | BPR6ES | 7822 | 2 | LPG 2 | 1497 |
| Kadett E | 1.8 | 66 | 09.90 - 09.91 | C18NZ OHC II | 4 | 0,9 | BPR5ES | 7422 | 6 | LPG 2 | 1497 |
| Kadett E | 1.8 | 74 | 09.85 - 09.86 | C18NE OHC II | 4 | 0,9 | BPR5ES | 7422 | 6 | LPG 2 | 1497 |
| Kadett E | 1.8 | 82 | 09.86 - 09.91 | 18SE OHC II | 4 | 0,8 | BPR6ES | 7822 | 2 | LPG 2 | 1497 |
| Kadett E | 1.8 | 85 | 09.84 - 09.86 | 18E OHC II | 4 | 0,8 | BPR6ES | 7822 | 2 | LPG 2 | 1497 |
| Kadett E | 2.0 | 85 | 09.86 - 09.91 | 20NE OHC | 4 | 0,9 | BPR5ES | 7422 | 6 | LPG 2 | 1497 |
| Kadett E | 2.0 | 85 | 09.86 - 03.93 | C20NE OHC | 4 | 0,9 | BPR5ES | 7422 | 6 | LPG 2 | 1497 |
| Kadett E | 2.0 | 91 | 03.87 - 09.91 | 20SER OHC II | 4 | 0,8 | BPR6ES | 7822 | 2 | LPG 2 | 1497 |
| Kadett E | 2.0 | 95 | 09.86 - 09.91 | 20SEH OHC II | 4 | 0,8 | BPR6ES | 7822 | 2 | LPG 2 | 1497 |
| Kadett E | 2.0 | 110 | 04.89 - 09.91 | 20XEJ DOHC | 4 | | BKR6EK | 2288 | 20 | LPG 1 | 1496 |
| Kadett E | 2.0 | 110 | 03.88 - 09.91 | C20XE DOHC | 4 | | BKR6EK | 2288 | 20 | LPG 1 | 1496 |
| Kadett E D | 1.6 | 40 | 09.84 - 02.89 | 16 D, DA OHC | 4 | ▣ | Y-924U | 4950 | | D-POWER 1 | 7906 |
| Kadett E D | 1.7 | 42 | 02.89 - 09.92 | 17 D OHC II | 4 | ▣ | Y-924U | 4950 | | D-POWER 1 | 7906 |
| Kadett E D | 1.7 | 44 | 09.92 - 09.93 | 17 DR | 4 | ▣ | Y-924U | 4950 | | D-POWER 1 | 7906 |
| Kadett E D (Isuzu-Mot.) | 1.5 | 37 | 09.84 - 08.91 | 4 EC1 Isuzu —> Mot. 804 794 | 4 | ▣ | Y-306R | 6244 | | | |
| Manta | 1.8 | 66 | 07.82 - 08.87 | 18S OHC | 4 | 0,8 | BPR6ES | 7822 | 2 | LPG 2 | 1497 |
| Meriva | 1.4 | 66 | 06.05 - | Z14XEP | 4 | 1,1 | ZFR5F-11 | 2262 | | LPG 6 | 1565 |
| Meriva | 1.6 | 64 | 05.03 - | Z16SE | 4 | | BKR5EK | 7956 | 23 | LPG 1 | 1496 |
| Meriva | 1.6 | 74 | 05.03 - | Z16XE | 4 | | BKR5EK | 7956 | 23 | LPG 1 | 1496 |
| Meriva | 1.6 | 77 | 01.06 - | Z16XEP | 4 | 1,1 | ZFR5F-11 | 2262 | | LPG 6 | 1565 |
| Meriva | 1.8 | 92 | 05.03 - | Z18XE | 4 | | BKR5EK | 7956 | 23 | LPG 1 | 1496 |
| Meriva Turbo OPC | 1.6 | 132 | 09 - | A16LET | 4 | | PFR6T-10G | 5542 | | PFR6T-10G | 5542 |
| Meriva Turbo OPC | 1.6 | 132 | 09.06 - | Z16LET | 4 | | PFR6T-10G | 5542 | | PFR6T-10G | 5542 |
| Meriva CDTI | 1.3 | 55 | 09.03 - | Z13DTJ | 4 | ▣ | Y8003J | 97256 | | D-POWER 62 | 97256 |
| Meriva CDTI | 1.7 | 74 | 09.03 - | Z17DTH | 4 | ▣ | Y-541J | 1983 | | D-POWER 42 | 1983 |
| Meriva CDTI | 1.7 | 92 | 01.08 - | A17DTR | 4 | ▣ | Y-541J | 1983 | | D-POWER 42 | 1983 |
| Meriva CDTI | 1.7 | 92 | 09.06 - | Z17DTR | 4 | ▣ | Y-541J | 1983 | | D-POWER 42 | 1983 |
| Meriva DTI | 1.7 | 55 | 09.03 - | Y17DT | 4 | ▣ | Y-541J | 1983 | | D-POWER 42 | 1983 |
| Monterey | 3.5 | 158 | 02.98 - 07.99 | 6VE1 | 6 | 1,1 | BKR5EVX-11 | 5182 | | LPG 1 | 1496 |
| Monterey 24V | 3.2 | 130 | 04.92 - 12.98 | 6VDI SOHC | 6 | 0,9 | BKR6E | 6962 | 28 | LPG 1 | 1496 |
| Monterey TD | 3.1 | 84 | 11.91 - 02.98 | 4JG2-TC (3.1 D) | 4 | ▣ | Y-719RS1 | 6900 | | | |
| Monza | 2.0 | 81 | 03.83 - 10.84 | 20E CIH | 4 | 0,7 | BPR6HS | 7022 | 3 | BPR7HIX | 5944 |
| Monza | 2.2 | 85 | 11.84 - 08.86 | 22E CIH | 4 | 0,7 | BPR6HS | 7022 | 3 | BPR7HIX | 5944 |
| Monza | 2.5 | 100 | 05.81 - 08.86 | 25E CIH | 6 | 0,7 | BPR6HS | 7022 | 3 | BPR7HIX | 5944 |
| Monza | 2.5 | 100 | 09.84 - 08.86 | S25E CIH | 6 | 0,7 | BPR6HS | 7022 | 3 | BPR7HIX | 5944 |
| Monza | 3.0 | 115 | 01.83 - 08.86 | 30E CIH | 6 | 0,7 | BPR6HS | 7022 | 3 | BPR7HIX | 5944 |
| Monza | 3.0 | 115 | 01.83 - 08.86 | C30NE | 6 | 0,7 | BPR6HS | 7022 | 3 | BPR7HIX | 5944 |



ℓ kW



Cyl.

Order-
No.VLINE
No.LPG/CNG
D-PowerOrder-
No.**OPEL**

| | | | | | | | | | | | |
|----------------------|-----|-----|-------------|------------------|---|-----|----------|------|----|------------|------|
| Monza | 3.0 | 132 | 01.83-08.86 | S30E CIH | 6 | 0,7 | BPR6HS | 7022 | 3 | BPR7HIX | 5944 |
| Movano 1.9 DTI | 1.9 | 59 | 09.00- | F9Q M7 | 4 | █ | Y-732J | 5605 | | D-POWER 4 | 5605 |
| Movano 2.2 DTI | 2.2 | 66 | 09.00- | G9T C7 | 4 | █ | Y-517J | 3319 | | | |
| Movano 2.5 D | 2.5 | 59 | 10.98-10.00 | S8U W7 | 4 | █ | Y-910J | 3617 | | D-POWER 3 | 3617 |
| Omega A | 1.8 | 60 | 09.86-03.94 | 18NV OHC II | 4 | 0,8 | BPR6ES | 7822 | 2 | LPG 2 | 1497 |
| Omega A | 1.8 | 60 | 09.87-03.90 | E18NVR OHC II | 4 | 0,8 | BPR6ES | 7822 | 2 | LPG 2 | 1497 |
| Omega A | 1.8 | 62 | 09.86-03.94 | S18NV OHC II | 4 | 0,8 | BPR6ES | 7822 | 2 | LPG 2 | 1497 |
| Omega A | 1.8 | 66 | 09.86-09.90 | 18SV OHC II | 4 | 0,8 | BPR6ES | 7822 | 2 | LPG 2 | 1497 |
| Omega A | 1.8 | 85 | 09.86-09.92 | 18SEH OHC II | 4 | 0,8 | BPR6ES | 7822 | 2 | LPG 2 | 1497 |
| Omega A | 2.0 | 74 | 09.86-03.94 | 20NE | 4 | 0,9 | BPR5ES | 7422 | 6 | LPG 2 | 1497 |
| Omega A | 2.0 | 74 | 09.86-03.94 | 20NEJ | 4 | | BKR6EK | 2288 | 20 | LPG 1 | 1496 |
| Omega A | 2.0 | 74 | 04.90-02.92 | C20NEJ OHC | 4 | | BKR6EK | 2288 | 20 | LPG 1 | 1496 |
| Omega A | 2.0 | 85 | 09.86-03.94 | C20NE OHC | 4 | 0,9 | BPR5ES | 7422 | 6 | LPG 2 | 1497 |
| Omega A | 2.0 | 90 | 09.89-03.94 | 20SE OHC II | 4 | | BKR6EK | 2288 | 20 | LPG 1 | 1496 |
| Omega A | 2.4 | 92 | 09.88-03.94 | C24NE CIH | 6 | 0,7 | BPR6HS | 7022 | 3 | BPR7HIX | 5944 |
| Omega A | 2.6 | 110 | 09.90-03.94 | C26NE CIH | 6 | 0,7 | BPR6HS | 7022 | 3 | BPR7HIX | 5944 |
| Omega A | 3.0 | 130 | 03.87-09.90 | 30NE CIH | 6 | 0,7 | BPR6HS | 7022 | 3 | BPR7HIX | 5944 |
| Omega A | 3.0 | 130 | 03.87-03.94 | C30NE CIH | 6 | 0,7 | BPR6HS | 7022 | 3 | BPR7HIX | 5944 |
| Omega A D | 2.3 | 54 | 09.86-02.94 | 23 YD OHC | 4 | █ | Y-924U | 4950 | | D-POWER 1 | 7906 |
| Omega A D | 2.3 | 66 | 09.86-09.88 | 23 YDT OHC | 4 | █ | Y-924U | 4950 | | D-POWER 1 | 7906 |
| Omega A TD | 2.3 | 74 | 09.88-02.94 | 23 DTR OHC | 4 | █ | Y-924U | 4950 | | D-POWER 1 | 7906 |
| Omega A 3000 | 3.0 | 115 | 03.87-09.90 | 30NE CIH | 6 | 0,7 | BPR6HS | 7022 | 3 | BPR7HIX | 5944 |
| Omega A 3000 | 3.0 | 115 | 03.87-03.88 | C30LE CIH | 6 | 0,7 | BPR6HS | 7022 | 3 | BPR7HIX | 5944 |
| Omega A 3000 | 3.0 | 115 | 03.87-03.94 | C30NE CIH | 6 | 0,7 | BPR6HS | 7022 | 3 | BPR7HIX | 5944 |
| Omega A 3000 24V | 3.0 | 147 | 09.89-03.94 | C30SE | 6 | | BKR6EK | 2288 | 20 | LPG 1 | 1496 |
| Omega A 3000 24V | 3.0 | 147 | 09.90-03.94 | C30SEJ DOHC | 6 | | BKR6EK | 2288 | 20 | LPG 1 | 1496 |
| Omega A 3000 24V Evo | 3.0 | 170 | 03.91-09.92 | C30XEI DOHC | 6 | | BKR6EK | 2288 | 20 | LPG 1 | 1496 |
| Omega B | 2.0 | 85 | 01.94-09.99 | 20SE OHC | 4 | | BKR5EK | 7956 | 23 | LPG 1 | 1496 |
| Omega B | 2.0 | 85 | 01.94-09.00 | X20SE OHC | 4 | | BKR5EK | 7956 | 23 | LPG 1 | 1496 |
| Omega B | 2.2 | 108 | 08.00- | Z22XE | 4 | | BKR5EK | 7956 | 23 | LPG 1 | 1496 |
| Omega B | 2.6 | 132 | 08.00-07.03 | Y26SE | 6 | | BKR5EQUA | 3566 | | | |
| Omega B | 3.2 | 160 | 05.01-07.03 | Y32SE | 6 | | BKR5EQUA | 3566 | | | |
| Omega B DTI | 2.0 | 74 | 09.99- | Y20DTH | 4 | █ | Y-523J | 6298 | | D-POWER 37 | 6298 |
| Omega B DTI 16V | 2.2 | 88 | 05.01- | Y22DTR | 4 | █ | Y-523J | 6298 | | D-POWER 37 | 6298 |
| Omega B 16V | 2.0 | 100 | 01.94-09.00 | X20XE DOHC | 4 | | BKR5EK | 7956 | 23 | LPG 1 | 1496 |
| Omega B 24V | 3.0 | 155 | 09.94-10.01 | X30XE DOHC | 6 | | BKR5EK | 7956 | 23 | LPG 1 | 1496 |
| Omega B D | 2.0 | 74 | 10.98-09.00 | X20DTH OHC | 4 | █ | Y-748U | 6649 | | D-POWER 14 | 6649 |
| Omega B DI 16V | 2.0 | 74 | 09.97- | X20DILC | 4 | █ | Y-748U | 6649 | | D-POWER 14 | 6649 |
| Omega B DTI 16V | 2.2 | 88 | 08.01- | Y22DTH | 4 | █ | Y-523J | 6298 | | D-POWER 37 | 6298 |
| Omega B TD | 2.5 | 96 | 02.94-02.96 | U25TD (Mot. BMW) | 6 | █ | Y-924J | 7906 | | D-POWER 1 | 7906 |
| Omega B TD | 2.5 | 96 | 08.96-10.01 | X25DT OHC | 6 | █ | Y-924J | 7906 | | D-POWER 1 | 7906 |
| Omega B V6 | 2.5 | 125 | 01.94-09.00 | X25XE DOHC | 6 | | BKR5EK | 7956 | 23 | LPG 1 | 1496 |
| Omega B 2.2 | 2.2 | 106 | 09.99-09.00 | Y22XE | 4 | | BKR5EK | 7956 | 23 | LPG 1 | 1496 |
| Omega-Lotus A | 3.6 | 265 | 09.90-09.92 | C36GET DOHC | 6 | | only OES | | | | |
| Rekord D D | 2.3 | | - 83 | | 4 | █ | Y-924J | 7906 | | D-POWER 1 | 7906 |
| Rekord E | 1.8 | 55 | 11.82-08.86 | 18N OHC | 4 | 0,8 | BPR6ES | 7822 | 2 | LPG 2 | 1497 |
| Rekord E | 1.8 | 59 | 03.84-08.86 | S18S OHC | 4 | 0,8 | BPR6ES | 7822 | 2 | LPG 2 | 1497 |
| Rekord E | 1.8 | 66 | 11.82-08.86 | 18S OHC | 4 | 0,8 | BPR6ES | 7822 | 2 | LPG 2 | 1497 |
| Rekord E | 1.8 | 74 | 05.85-08.86 | C18NV OHC | 4 | 0,8 | BPR6ES | 7822 | 2 | LPG 2 | 1497 |
| Rekord E | 2.2 | 85 | 11.84-08.86 | 22E CIH | 4 | 0,7 | BPR6HS | 7022 | 3 | BPR7HIX | 5944 |
| Rekord E D | 2.3 | 48 | 11.82-08.86 | Mot.-Nr. 40019 → | 4 | █ | Y-208T | 1250 | | | |
| Rekord E TD | 2.3 | 63 | 05.84-09.86 | 23 DT | 4 | █ | Y-924U | 4950 | | D-POWER 1 | 7906 |



l kW



Cyl.

Order-
No. No.LPG/CNG
D-PowerOrder-
No.**OPEL**

| | | | | | | | | | | | |
|-----------------|-----|-----|---------------|--------------------|---|-----|------------|-------|----|------------|-------|
| Senator A | 2.0 | 81 | 02.83 - 10.84 | 20E CIH | 4 | 0,7 | BPR6HS | 7022 | 3 | BPR7HIX | 5944 |
| Senator A | 2.2 | 85 | 11.84 - 07.86 | 22E | 6 | 0,7 | BPR6HS | 7022 | 3 | BPR7HIX | 5944 |
| Senator A | 2.5 | 100 | 05.81 - 07.86 | 25E CIH | 6 | 0,7 | BPR6HS | 7022 | 3 | BPR7HIX | 5944 |
| Senator A | 2.5 | 100 | 09.84 - 08.87 | S25E CIH | 6 | 0,7 | BPR6HS | 7022 | 3 | BPR7HIX | 5944 |
| Senator A | 3.0 | 132 | 01.83 - 08.87 | S30E CIH | 6 | 0,7 | BPR6HS | 7022 | 3 | BPR7HIX | 5944 |
| Senator A D | 2.0 | | | —> Mot.-Nr. 90309 | 4 | █ | Y-403T | 7494 | | | |
| Senator A D | 2.0 | | | Mot.-Nr. 90310 —> | 4 | █ | Y-208T | 1250 | | | |
| Senator A D | 2.3 | 64 | 11.84 - 08.87 | —> Mot.-Nr. 40018 | 4 | █ | Y-403T | 7494 | | | |
| Senator A D | 2.3 | 70 | 03.85 - 07.86 | 23 TDC | 4 | █ | Y-924U | 4950 | | D-POWER 1 | 7906 |
| Senator A TD | 2.3 | 64 | 11.84 - 08.87 | Mot.-Nr. 121527 —> | 4 | █ | Y-924U | 4950 | | D-POWER 1 | 7906 |
| Senator B | 2.5 | 103 | 03.88 - 09.90 | 25NE CIH | 6 | 0,7 | BPR6HS | 7022 | 3 | BPR7HIX | 5944 |
| Senator B | 2.6 | 110 | 09.90 - 09.93 | C26NE CIH | 6 | 0,7 | BPR6HS | 7022 | 3 | BPR7HIX | 5944 |
| Senator B | 3.0 | 115 | 08.87 - 09.90 | C30LE CIH | 6 | 0,7 | BPR6HS | 7022 | 3 | BPR7HIX | 5944 |
| Senator B | 3.0 | 130 | 08.87 - 09.90 | 30NE CIH | 6 | 0,7 | BPR6HS | 7022 | 3 | BPR7HIX | 5944 |
| Senator B | 3.0 | 150 | 09.89 - 06.93 | C30SE DOHC | 6 | | BKR6EK | 2288 | 20 | LPG 1 | 1496 |
| Senator B | 3.6 | 145 | 08.89 - 09.93 | C3,6NE irmscher | 6 | 0,7 | BPR6HS | 7022 | 3 | BPR7HIX | 5944 |
| Senator B | 3.6 | 145 | 08.89 - 09.93 | C3,6NEI irmscher | 6 | 0,7 | BPR6HS | 7022 | 3 | BPR7HIX | 5944 |
| Senator B | 4.0 | 200 | 01.91 - 09.93 | C40SE irmscher | 6 | 0,7 | BPR6HS | 7022 | 3 | BPR7HIX | 5944 |
| Signum | 1.6 | 74 | 03 - | Z16XE DOHC | 4 | | BKR5EQUPA | 3566 | | | |
| Signum | 1.8 | 85 | 05.03 - | Z18XEL | 4 | | BKR5EQUPA | 3566 | | | |
| Signum | 1.8 | 103 | 09.05 - | Z18XER | 4 | 1,1 | ZFR5F-11 | 2262 | | LPG 6 | 1565 |
| Signum | 2.2 | 108 | 05.03 - | Z22SE | 4 | | LTR6B-10T | 5948 | | LTR6B-10T | 5948 |
| Signum 16V | 1.8 | 90 | 05.03 - | Z18XE | 4 | | BKR5EQUPA | 3566 | | | |
| Signum 3.2 V6 | 3.2 | 155 | 05.03 - | Z32SE | 6 | | BKR5EQUPA | 3566 | | | |
| Signum CDTI | 1.9 | 74 | 06.05 - | Z19DTL Fiat | 4 | █ | Y-534J | 3413 | | D-POWER 36 | 3413 |
| Signum CDTI | 1.9 | 88 | 04.04 - | Z19DT Fiat | 4 | █ | Y-534J | 3413 | | D-POWER 36 | 3413 |
| Signum CDTI 16V | 1.9 | 110 | 04.04 - | Z19DTH Fiat | 4 | █ | YE07 | 6092 | | | |
| Signum DI 16V | 2.2 | 114 | 05.03 - | Z22YH | 4 | | BKR5EQUPA | 3566 | | | |
| Signum DTI 16V | 2.0 | 74 | 05.03 - | Y20DTH | 4 | █ | Y-523J | 6298 | | D-POWER 37 | 6298 |
| Signum DTI 16V | 2.2 | 92 | 05.03 - | Y22DTR | 4 | █ | Y-523J | 6298 | | D-POWER 37 | 6298 |
| Signum Turbo | 2.0 | 129 | 05.03 - | Z20NET | 4 | | PFR6T-10G | 5542 | | PFR6T-10G | 5542 |
| Signum V6 Turbo | 2.8 | 169 | 09.05 - 07 | Z28NEL | 6 | 1,0 | PLFR6C-10G | 1959 | | PLFR6C-10G | 1959 |
| Signum V6 Turbo | 2.8 | 184 | 01.06 - | Z28NET | 6 | 1,0 | PLFR6C-10G | 1959 | | PLFR6C-10G | 1959 |
| Sintra 16V | 2.2 | 104 | 09.96 - 09.99 | X22XE DOHC | 4 | | BKR5EK | 7956 | 23 | LPG 1 | 1496 |
| Sintra 24V | 3.0 | 155 | 09.96 - 09.99 | X30XE DOHC | 6 | | BKR5EK | 7956 | 23 | LPG 1 | 1496 |
| Sintra TDI | 2.2 | 85 | 01.98 - | X22DTH | 4 | █ | Y-748U | 6649 | | D-POWER 14 | 6649 |
| Speedster | 2.2 | 108 | 04.00 - 06 | Z22SE | 4 | | LTR6B-10T | 5948 | | LTR6B-10T | 5948 |
| Speedster Turbo | 2.0 | 147 | 03 - | Z20LET | 4 | | BKR5EK | 7956 | 23 | LPG 1 | 1496 |
| Tigra A | 1.4 | 63 | 08.97 - 12.00 | C14SEL OHC | 4 | | BKR5EK | 7956 | 23 | LPG 1 | 1496 |
| Tigra A | 1.6 | 74 | 06.97 - 08.98 | C16SEL DOHC | 4 | | BKR5EK | 7956 | 23 | LPG 1 | 1496 |
| Tigra A 16V | 1.4 | 66 | 08.94 - 12.00 | X14XE DOHC | 4 | | BKR5EK | 7956 | 23 | LPG 1 | 1496 |
| Tigra A 16V | 1.6 | 78 | 08.94 - 08.98 | X16XE DOHC | 4 | | BKR5EK | 7956 | 23 | LPG 1 | 1496 |
| Tigra B | 1.4 | 66 | 06.04 - | Z14XEP | 4 | 1,1 | ZFR5F-11 | 2262 | | LPG 6 | 1565 |
| Tigra B | 1.8 | 92 | 06.04 - | Z18XE | 4 | 1,1 | ZFR5F-11 | 2262 | | LPG 6 | 1565 |
| Tigra CDTI | 1.3 | 52 | 06.04 - | Z13DT | 4 | █ | Y8003J | 97256 | | D-POWER 62 | 97256 |
| Vectra | 1.7 | | - 83 | | 4 | █ | Y-924J | 7906 | | D-POWER 1 | 7906 |
| Vectra B | 1.6 | 55 | 08.95 - | 16LZ2 OHC | 4 | | BKR5EK | 7956 | 23 | LPG 1 | 1496 |
| Vectra B | 1.6 | 55 | 08.95 - 09.00 | X16SZR OHC | 4 | | BKR5EK | 7956 | 23 | LPG 1 | 1496 |
| Vectra B | 1.6 | 74 | 08.95 - 09.00 | X16XEL DOHC | 4 | | BKR5EK | 7956 | 23 | LPG 1 | 1496 |
| Vectra B | 1.6 | 74 | 08.00 - 04.02 | Z16XE DOHC | 4 | | BKR5EK | 7956 | 23 | LPG 1 | 1496 |
| Vectra B | 1.8 | 85 | 08.95 - 09.00 | X18XE | 4 | | BKR5EK | 7956 | 23 | LPG 1 | 1496 |
| Vectra B | 1.8 | 85 | 03.99 - 09.00 | X18XE1 | 4 | | BKR5EK | 7956 | 23 | LPG 1 | 1496 |



ℓ kW

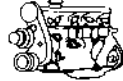

Cyl.

Order-
No.VLINE
No.LPG/CNG
D-PowerOrder-
No.**OPEL**

| | | | | | | | | | | | |
|--------------------|-----|-----|-------------|-----------------------|---|-----|------------|------|----|------------|------|
| Vectra B | 1.8 | 85 | 08.00-04.02 | Z18XEL | 4 | | BKR5EK | 7956 | 23 | LPG 1 | 1496 |
| Vectra B | 1.8 | 92 | 08.00-04.02 | Z18XE | 4 | | BKR5EK | 7956 | 23 | LPG 1 | 1496 |
| Vectra B | 2.0 | 80 | 08.95- | Z0NEJ OHC | 4 | | BKR5EK | 7956 | 23 | LPG 1 | 1496 |
| Vectra B | 2.0 | 100 | 02.97- | C20SEL DOHC | 4 | | BKR5EK | 7956 | 23 | LPG 1 | 1496 |
| Vectra B | 2.0 | 100 | 08.95-09.00 | X20XEV | 4 | | BKR5EK | 7956 | 23 | LPG 1 | 1496 |
| Vectra B | 2.2 | 106 | 10.99- | C22SEL DOHC | 4 | | BKR5EK | 7956 | 23 | LPG 1 | 1496 |
| Vectra B | 2.2 | 108 | 08.00-04.02 | Z22SE | 4 | | LTR6B-10T | 5948 | | LTR6B-10T | 5948 |
| Vectra B Di | 2.0 | 60 | 08.96-07.99 | X20DTL SOHC | 4 | ■ | Y-604J | 6157 | | | |
| Vectra B Di | 2.0 | 60 | 08.99-04.02 | X20DTL SOHC | 4 | ■ | Y-748U | 6649 | | D-POWER 14 | 6649 |
| Vectra B DTI | 2.0 | 74 | 08.97-04.02 | X20DTH OHC | 4 | ■ | Y-748U | 6649 | | D-POWER 14 | 6649 |
| Vectra B DTI 16V | 2.0 | 74 | 09.97-07.99 | X20DILC | 4 | ■ | Y-748U | 6649 | | D-POWER 14 | 6649 |
| Vectra B DTI 16V | 2.0 | 74 | 08.00-04.02 | Y20DTH | 4 | ■ | Y-523J | 6298 | | D-POWER 37 | 6298 |
| Vectra B TD | 1.7 | 60 | 08.95-12.98 | X17TD / TC4 EE1 Isuzu | 4 | ■ | CY03 | 6160 | | D-POWER 8 | 6160 |
| Vectra B DTI 16V | 2.2 | 92 | 08.00-04.02 | Y22DTR | 4 | ■ | Y-523J | 6298 | | D-POWER 37 | 6298 |
| Vectra B i500 | 2.5 | 143 | 01.98-09.00 | X25XE DOHC | 6 | | BKR5EK | 7956 | 23 | LPG 1 | 1496 |
| Vectra B V6 | 2.5 | 125 | 08.95-09.00 | X25XE DOHC | 6 | | BKR5EK | 7956 | 23 | LPG 1 | 1496 |
| Vectra B V6 | 2.6 | 125 | 08.00-07.03 | Y26SE | 6 | | BKR5EQUPA | 3566 | | | |
| Vectra C | 1.6 | 74 | 06.04- | Z16XE DOHC | 4 | | BKR5EQUPA | 3566 | | | |
| Vectra C | 1.6 | 77 | 01.06- | Z16XEP | 4 | 1,1 | ZFR5F-11 | 2262 | | LPG 6 | 1565 |
| Vectra C | 1.8 | 81 | 04.02- | Z18XEL | 4 | | BKR5EQUPA | 3566 | | | |
| Vectra C | 1.8 | 103 | 01.06- | Z18XER | 4 | 1,1 | ZFR5F-11 | 2262 | | LPG 6 | 1565 |
| Vectra C 16V | 1.8 | 92 | 08.02- | Z18XE | 4 | | BKR5EQUPA | 3566 | | | |
| Vectra C 16V | 2.2 | 108 | 08.02- | Z22SE | 4 | | LTR6B-10T | 5948 | | LTR6B-10T | 5948 |
| Vectra C CDTI | 1.9 | 74 | 06.05- | Z19DTL Fiat | 4 | ■ | Y-534J | 3413 | | D-POWER 36 | 3413 |
| Vectra C CDTI | 1.9 | 88 | 04.04- | Z19DT Fiat | 4 | ■ | Y-534J | 3413 | | D-POWER 36 | 3413 |
| Vectra C CDTI 16V | 1.9 | 110 | 04.04- | Z19DTH Fiat | 4 | ■ | YE07 | 6092 | | | |
| Vectra C DI 16V | 2.2 | 114 | 10.03- | Z22YH | 4 | | BKR5EQUPA | 3566 | | | |
| Vectra C DTI | 2.0 | 74 | 04.02- | Y20DTH | 4 | ■ | Y-523J | 6298 | | D-POWER 37 | 6298 |
| Vectra C DTI | 2.2 | 92 | 04.02- | Y22DTR | 4 | ■ | Y-523J | 6298 | | D-POWER 37 | 6298 |
| Vectra C GTS | 3.2 | 155 | 08.02- | Z32SE | 6 | | BKR5EQUPA | 3566 | | | |
| Vectra C GTS Turbo | 2.0 | 129 | 03.03- | Z20NET | 4 | | PFR6T-10G | 5542 | | PFR6T-10G | 5542 |
| Vectra C V6 Turbo | 2.8 | 169 | 09.05-07 | Z28NEL | 6 | 1,0 | PLFR6C-10G | 1959 | | PLFR6C-10G | 1959 |
| Vectra C V6 Turbo | 2.8 | 184 | 08.06- | Z28NET | 6 | 1,0 | PLFR6C-10G | 1959 | | PLFR6C-10G | 1959 |
| Vectra A | 1.4 | 55 | 09.88-09.92 | 14NV OHC I | 4 | 0,8 | BPR6ES | 7822 | 2 | LPG 2 | 1497 |
| Vectra A | 1.6 | 52 | 09.93-08.95 | X16SZ OHC | 4 | | BKR5EK | 7956 | 23 | LPG 1 | 1496 |
| Vectra A | 1.6 | 55 | 09.88-08.94 | C16NZ | 4 | 0,9 | BPR5ES | 7422 | 6 | LPG 2 | 1497 |
| Vectra A | 1.6 | 55 | 09.88-09.89 | E16NZ OHC | 4 | | BKR5EK | 7956 | 23 | LPG 1 | 1496 |
| Vectra A | 1.6 | 60 | 09.88-09.92 | 16SV OHC I | 4 | 0,8 | BPR6ES | 7822 | 2 | LPG 2 | 1497 |
| Vectra A | 1.8 | 65 | 09.88-08.95 | E18NVR OHC II | 4 | 0,8 | BPR6ES | 7822 | 2 | LPG 2 | 1497 |
| Vectra A | 1.8 | 66 | 09.89-08.95 | 18SV | 4 | 0,8 | BPR6ES | 7822 | 2 | LPG 2 | 1497 |
| Vectra A | 1.8 | 66 | 03.90-08.95 | C18NZ OHC II | 4 | | BKR5EK | 7956 | 23 | LPG 1 | 1496 |
| Vectra A | 1.8 | 66 | 09.89-08.95 | C18SV OHC | 4 | 0,8 | BPR6ES | 7822 | 2 | LPG 2 | 1497 |
| Vectra A | 2.0 | 85 | 09.89-08.95 | Z0NE | 4 | | BKR5EK | 7956 | 23 | LPG 1 | 1496 |
| Vectra A | 2.0 | 85 | 09.89-08.95 | C20NE OHC | 4 | | BKR5EK | 7956 | 23 | LPG 1 | 1496 |
| Vectra A | 2.0 | 95 | 09.88-09.92 | Z0SEH OHC II | 4 | 0,8 | BPR6ES | 7822 | 2 | LPG 2 | 1497 |
| Vectra A | 2.0 | 150 | 09.92-08.95 | C20LET DOHC | 4 | 1,1 | ZFR6F-11 | 4291 | | LPG 6 | 1565 |
| Vectra A | 2.5 | 125 | 02.93-08.95 | Z25XE | 6 | | BKR5EK | 7956 | 23 | LPG 1 | 1496 |
| Vectra A | 2.5 | 125 | 03.93-08.95 | C25XE DOHC | 6 | | BKR5EK | 7956 | 23 | LPG 1 | 1496 |
| Vectra A D | 1.7 | 42 | 02.88-09.92 | 17D OHC II | 4 | ■ | Y-924U | 4950 | | D-POWER 1 | 7906 |
| Vectra A TD | 1.7 | 60 | 10.92-08.95 | 17DT Isuzu TC4EE1 | 4 | ■ | CY03 | 6160 | | D-POWER 8 | 6160 |
| Vectra A TD | 1.7 | 60 | 03.90- | Isuzu TC4EC1 817253→ | 4 | ■ | Y-743U | 5642 | | | |
| Vectra A TD | 1.7 | 60 | 10.92-08.95 | X17DT Isuzu TC4EE1 | 4 | ■ | CY03 | 6160 | | D-POWER 8 | 6160 |



ℓ kW



Cyl.

Order-
No. No.LPG/CNG
D-PowerOrder-
No.**OPEL**

| | | | | | | | | | | | |
|-----------------------|-----|-----|---------------|---------------|---|-----|-----------|------|----|------------|------|
| Vectra A 16V | 2.0 | 100 | 08.92 - 08.95 | 20XE | 4 | | BKR5EK | 7956 | 23 | LPG 1 | 1496 |
| Vectra A 16V | 2.0 | 100 | 08.92 - 08.95 | C20XE | 4 | | BKR5EK | 7956 | 23 | LPG 1 | 1496 |
| Vectra A 16V | 2.0 | 100 | 08.92 - 08.95 | C20XE-LN | 4 | | BKR5EK | 7956 | 23 | LPG 1 | 1496 |
| Vectra A 16V | 2.0 | 100 | 12.94 - 08.95 | X20XEV DOHC | 4 | | BKR5EK | 7956 | 23 | LPG 1 | 1496 |
| Vectra A 2000 16V | 2.0 | 110 | 09.89 - 08.92 | 20XE | 4 | | BKR6EK | 2288 | 20 | LPG 1 | 1496 |
| Vectra A 2000 16V | 2.0 | 110 | 09.89 - 08.92 | C20XE DOHC | 4 | | BKR6EK | 2288 | 20 | LPG 1 | 1496 |
| Vectra A 2000 16V 4x4 | 2.0 | 110 | 09.89 - 08.92 | 20XE | 4 | | BKR6EK | 2288 | 20 | LPG 1 | 1496 |
| Vectra A 2000 16V 4x4 | 2.0 | 110 | 09.89 - 08.92 | C20XE DOHC | 4 | | BKR6EK | 2288 | 20 | LPG 1 | 1496 |
| Vectra A 4x4 | 1.8 | 65 | 01.89 - 08.95 | E18NVR OHC II | 4 | 0,8 | BPR6ES | 7822 | 2 | LPG 2 | 1497 |
| Vectra A 4x4 | 1.8 | 66 | 09.89 - 08.95 | 18SV | 4 | 0,8 | BPR6ES | 7822 | 2 | LPG 2 | 1497 |
| Vectra A 4x4 | 1.8 | 66 | 09.89 - 08.95 | C18SV OHC | 4 | 0,8 | BPR6ES | 7822 | 2 | LPG 2 | 1497 |
| Vectra A 4x4 | 2.0 | 85 | 01.89 - 08.95 | 20NE | 4 | | BKR5EK | 7956 | 23 | LPG 1 | 1496 |
| Vectra A 4x4 | 2.0 | 85 | 01.89 - 08.95 | C20NE OHC | 4 | | BKR5EK | 7956 | 23 | LPG 1 | 1496 |
| Vectra A 4x4 | 2.0 | 95 | 01.89 - 09.92 | 20SEH OHC II | 4 | 0,8 | BPR6ES | 7822 | 2 | LPG 2 | 1497 |
| Vivaro | 2.0 | 86 | 08.01 - | | 4 | 0,9 | PFR6G-9 | 4377 | | PFR7G | 4364 |
| Vivaro 16V | 2.0 | 88 | 09.01 - | F4R 720 | 4 | 0,9 | PFR6G-9 | 4377 | | PFR7G | 4364 |
| Vivaro DI | 1.9 | 60 | 09.01 - | | 4 | █ | Y-732J | 5605 | | D-POWER 4 | 5605 |
| Vivaro DTI | 1.9 | 74 | 09.01 - | F9Q 760 | 4 | █ | Y-732J | 5605 | | D-POWER 4 | 5605 |
| Vivaro DTI | 2.5 | 98 | 05.03 - | G9U - 730 | 4 | █ | Y-517J | 3319 | | | |
| Zafira CNG | 1.6 | 71 | 09.01 - | Z16YNG | 4 | | LPG 1 | 1496 | | LPG 1 | 1496 |
| Zafira 16V | 1.6 | 74 | 03.99 - | X16XE DOHC | 4 | | BKR5EK | 7956 | 23 | LPG 1 | 1496 |
| Zafira 16V | 1.6 | 74 | 08.00 - | Z16XE | 4 | | BKR5EK | 7956 | 23 | LPG 1 | 1496 |
| Zafira 16V | 1.8 | 85 | 03.99 - 09.00 | X18XE DOHC | 4 | | BKR5EK | 7956 | 23 | LPG 1 | 1496 |
| Zafira 16V | 1.8 | 92 | 09.00 - | Z18XE | 4 | | BKR5EK | 7956 | 23 | LPG 1 | 1496 |
| Zafira 16V | 2.2 | 108 | 08.00 - 06 | Z22SE | 4 | | LTR6B-10T | 5948 | | LTR6B-10T | 5948 |
| Zafira A 16V | 1.8 | 85 | 04.99 - 09.00 | X18XE1 | 4 | | BKR5EK | 7956 | 23 | LPG 1 | 1496 |
| Zafira B | 1.6 | 85 | 01.08 - | Z16XER | 4 | 1,1 | ZFR5F-11 | 2262 | | LPG 6 | 1565 |
| Zafira B 16V | 1.6 | 74 | 07.05 - | Z16XEP | 4 | 1,1 | ZFR5F-11 | 2262 | | LPG 6 | 1565 |
| Zafira B 16V | 1.8 | 103 | 07.05 - | Z18XER | 4 | 1,1 | ZFR5F-11 | 2262 | | LPG 6 | 1565 |
| Zafira B CDTI | 1.7 | 81 | 01.08 - | A17DTJ | 4 | █ | Y-541J | 1983 | | D-POWER 42 | 1983 |
| Zafira B CDTI | 1.7 | 92 | 01.08 - | A17DTR | 4 | █ | Y-541J | 1983 | | D-POWER 42 | 1983 |
| Zafira B CDTI | 1.9 | 74 | 07.05 - | Z19DTL Fiat | 4 | █ | Y-534J | 3413 | | D-POWER 36 | 3413 |
| Zafira B CDTI | 1.9 | 88 | 07.05 - | Z19DT Fiat | 4 | █ | Y-534J | 3413 | | D-POWER 36 | 3413 |
| Zafira B CDTI 16V | 1.9 | 110 | 07.05 - | Z19DTH Fiat | 4 | █ | YE07 | 6092 | | | |
| Zafira B CNG | 1.6 | 69 | 05 - | Y16YNG | 4 | | LPG 1 | 1496 | | LPG 1 | 1496 |
| Zafira B DI | 2.2 | 110 | 07.05 - | Z22YH | 4 | | BKR5EQUPA | 3566 | | | |
| Zafira B OPC | 2.0 | 177 | 09.05 - | Z20LEH | 4 | | PFR6T-G | 6314 | | PFR6T-G | 6314 |
| Zafira B Turbo | 2.0 | 147 | 07.05 - | Z20LER | 4 | 0,7 | ZFR5F | 5165 | | LPG 6 | 1565 |
| Zafira DI 16V | 2.0 | 60 | 09.99 - 11.00 | X20DTL | 4 | █ | Y-748U | 6649 | | D-POWER 14 | 6649 |
| Zafira DTI 16V | 2.0 | 74 | 04.99 - | X20DILC | 4 | █ | Y-748U | 6649 | | D-POWER 14 | 6649 |
| Zafira DTI 16V | 2.0 | 74 | 08.00 - | Y20DTH | 4 | █ | Y-523J | 6298 | | D-POWER 37 | 6298 |
| Zafira DTI 16V | 2.0 | 74 | 08.99 - | Y20DTL | 4 | █ | Y-748U | 6649 | | D-POWER 14 | 6649 |
| Zafira DTI 16V | 2.2 | 92 | 01.02 - 06.05 | Y22DTR | 4 | █ | Y-523J | 6298 | | D-POWER 37 | 6298 |
| Zafira Turbo 16V OPC | 2.0 | 141 | 01 - | Z20LET | 4 | | BKR5EK | 7956 | 23 | LPG 1 | 1496 |

PANTHER

| | | | | | | | | | | | |
|-------------|-----|----|---------------|------|---|-----|--------|------|----|-------|------|
| Deville | 4.2 | | | | | 0,8 | BP5ES | 6511 | 8 | LPG 2 | 1497 |
| Deville V12 | 4.2 | | | | | 0,8 | BP5ES | 6511 | 8 | LPG 2 | 1497 |
| J72 V12 | 4.2 | | | | | 0,8 | BP5ES | 6511 | 8 | LPG 2 | 1497 |
| J72SE | 4.2 | | | | | 0,8 | BP5ES | 6511 | 8 | LPG 2 | 1497 |
| Kalistra | 1.6 | 71 | 01.82 - 12.92 | Ford | 4 | 0,9 | BKR6E | 6962 | 28 | LPG 1 | 1496 |
| Kalistra V6 | 2.8 | 99 | 01.82 - 12.89 | Ford | 6 | 0,8 | BPR6ES | 7822 | 2 | LPG 2 | 1497 |



ℓ kW

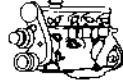

Cyl.

Order-
No.LPG/CNG
D-PowerOrder-
No.**PANTHER**

| | | | | | | | | | | | |
|-------------|--|--|--|--|---|-----|--------|------|---|-------|------|
| R10 Spezial | | | | | 4 | 0,8 | BP6EFS | 3812 | 5 | LPG 5 | 1516 |
|-------------|--|--|--|--|---|-----|--------|------|---|-------|------|

PERODUA

| | | | | | | | | | | | |
|--------|------|--|---------------|-------|---|-----|---------|------|---|-------|------|
| Kenari | 0.85 | | 00 - | EJ-VE | 3 | | BKR5EKC | 5216 | | | |
| Kenari | 1.0 | | 11.00 - | EJ-VE | 3 | | BKR5EKC | 5216 | | | |
| Nippa | 0.85 | | 08.97 - 01.00 | | 3 | 0,9 | BPR5ES | 7422 | 6 | LPG 2 | 1497 |

PEUGEOT

| | | | | | | | | | | | |
|------------------------|-----|----|---------------|----------------|---|-----|----------|------|----|------------|------|
| 1007 1.4i | 1.4 | 55 | 04.05 - | | 4 | 1,1 | BKR6E-11 | 2756 | 14 | LPG 1 | 1496 |
| 1007 1.6i | 1.6 | 81 | 04.05 - | | 4 | 0,9 | LFR6B | 6677 | | LPG 7 | 1640 |
| 1007 1.4 16V | 1.4 | 65 | 10.05 - | ET3J4 | 4 | 0,8 | LZKAR7A | 6799 | | | |
| 1007 Hdi | 1.4 | 51 | 01.05 - | DV4TD | 4 | █ | YE05 | 5207 | | | |
| 1007 Hdi | 1.4 | 68 | | DV6TD | 4 | █ | YE05 | 5207 | | | |
| 104 ZS | 1.4 | 59 | 07.82 - 06.86 | XY8 | 4 | 0,6 | BP7EFS | 3526 | | | |
| 106 (2) Pop Art | 1.1 | 44 | 05.00 - | TU1JP | 4 | 0,9 | BKR6EZ | 4619 | 38 | LPG 1 | 1496 |
| 106 (2) Rallye | 1.6 | 74 | 06.96 - | TU5J2 NFW | 4 | | BKR6EK | 2288 | 20 | LPG 1 | 1496 |
| 106 Rallye | 1.3 | 74 | 11.93 - 03.96 | TU2J2-MFZ | 4 | | BKR6EK | 2288 | 20 | LPG 1 | 1496 |
| 106 XN | 0.9 | 37 | 08.91 - 12.92 | TU9-C1A | 4 | 0,8 | BCP5ES | 7496 | 16 | LPG 3 | 1498 |
| 106 XN, XR | 1.1 | 38 | 08.91 - 12.92 | TU1-H1A | 4 | 0,8 | BCP5ES | 7496 | 16 | LPG 3 | 1498 |
| 106 XR, XT | 1.4 | 51 | 08.91 - 12.92 | TU3.2-K2D | 4 | 0,7 | BCP6ES | 4930 | 17 | LPG 3 | 1498 |
| 106 Xsi | 1.4 | 55 | 07.92 - 03.96 | TU3JP cat. KFX | 4 | | BKR6EK | 2288 | 20 | LPG 1 | 1496 |
| 106 Xsi | 1.4 | 55 | 08.91 - 12.92 | TU3JP KFX | 4 | | BKR6EK | 2288 | 20 | LPG 1 | 1496 |
| 106 Xsi | 1.6 | 74 | 07.95 - 05.96 | TU5J2 NFW | 4 | | BKR6EK | 2288 | 20 | LPG 1 | 1496 |
| 106 Xsi | 1.6 | 74 | 12.93 - 06.95 | TU5J2 NFW | 4 | 0,8 | BKR6ES | 3783 | 28 | LPG 1 | 1496 |
| 106 16V (2) S16, Gti | 1.6 | 88 | 01.00 - | TU5J4 NFX | 4 | 0,9 | BKR6EZ | 4619 | 38 | LPG 1 | 1496 |
| 106 16V (2) S16, Gti | 1.6 | 88 | 06.96 - 12.99 | TU5J4 NFX | 4 | | BKR6EK | 2288 | 20 | LPG 1 | 1496 |
| 106 D | 1.4 | 37 | 08.91 - 06.94 | TUD3/L | 4 | █ | Y-910J | 3617 | | D-POWER 3 | 3617 |
| 106 D | 1.5 | 42 | 04.96 - 10.03 | TUD5 | 4 | █ | Y-503J | 1009 | | D-POWER 10 | 1009 |
| 106 D | 1.5 | 42 | 07.94 - 03.96 | TUD5 | 4 | █ | Y-503J | 1009 | | D-POWER 10 | 1009 |
| 106i (2) | 1.1 | 44 | 04.96 - | TU1M+ HDZ | 4 | | BKR6EK | 2288 | 20 | LPG 1 | 1496 |
| 106i (2) | 1.4 | 55 | 01.00 - | TU3JP KFX | 4 | 0,9 | BKR6EZ | 4619 | 38 | LPG 1 | 1496 |
| 106i (2) | 1.4 | 55 | 04.96 - 12.99 | TU3JP KFX | 4 | | BKR6EK | 2288 | 20 | LPG 1 | 1496 |
| 106i (2) | 1.6 | 66 | 01.00 - | TU5JP NFZ | 4 | 0,9 | BKR6EZ | 4619 | 38 | LPG 1 | 1496 |
| 106i (2) | 1.6 | 66 | 04.96 - 12.99 | TU5JP NFZ | 4 | | BKR6EK | 2288 | 20 | LPG 1 | 1496 |
| 106i (2), Kid | 1.0 | 37 | 04.96 - | TU9M CDZ /Y | 4 | | BKR5EK | 7956 | 23 | LPG 1 | 1496 |
| 106i XN, XA, Kid | 0.9 | 37 | 07.92 - 06.95 | TU9M-CDZ | 4 | 0,8 | BCPR5ES | 6130 | 32 | LPG 3 | 1498 |
| 106i XN, XA, Kid | 0.9 | 37 | 07.95 - 03.96 | TU9M-CDZ | 4 | | BKR5EK | 7956 | 23 | LPG 1 | 1496 |
| 106i XN, XR, XT, Green | 1.1 | 44 | 07.92 - 06.95 | TU1M-HDZ | 4 | 0,8 | BCPR5ES | 6130 | 32 | LPG 3 | 1498 |
| 106i XN, XR, XT, Green | 1.1 | 44 | 07.95 - 03.96 | TU1M-HDZ | 4 | | BKR6EK | 2288 | 20 | LPG 1 | 1496 |
| 106i XR, XS, XT | 1.4 | 55 | 07.92 - 06.95 | TU3MC KDX | 4 | 0,8 | BCPR5ES | 6130 | 32 | LPG 3 | 1498 |
| 106i XR, XS, XT | 1.4 | 55 | 07.95 - 03.96 | TU3MC KDX | 4 | | BKR6EK | 2288 | 20 | LPG 1 | 1496 |
| 106i XS, XT, Griffe | 1.6 | 66 | 07.94 - 03.96 | TU5JP NFZ | 4 | | BKR6EK | 2288 | 20 | LPG 1 | 1496 |
| 107 12V | 1.0 | 50 | 06.05 - | | 3 | 1,1 | LFR6C-11 | 5788 | | | |
| 107 Hdi | 1.4 | 51 | 01.05 - | DV4 | 4 | █ | YE05 | 5207 | | | |
| 107 Hdi | 1.4 | 51 | 01.05 - | DV4TD | 4 | █ | YE04 | 1684 | | D-POWER 40 | 1684 |
| 205 | 1.1 | 44 | -06.92 | | 4 | 0,8 | BCPR6ES | 2330 | 12 | LPG 3 | 1498 |
| 205 | 1.1 | 44 | | TU1M | 4 | | BKR5EK | 7956 | 23 | LPG 1 | 1496 |
| 205 | 1.4 | 55 | | TU3M | 4 | | BKR6EK | 2288 | 20 | LPG 1 | 1496 |
| 205 | 1.8 | 58 | 09.98 - 12.99 | XUD7T | 4 | █ | Y-938R | 5267 | | D-POWER 1 | 7906 |
| 205 | 1.9 | 51 | 09.98 - 12.99 | XUD9A | 4 | █ | Y-938R | 5267 | | D-POWER 1 | 7906 |
| 205 CT | 1.4 | 52 | 02.83 - 10.87 | XY6.B | 4 | 0,8 | BP6EFS | 3812 | 5 | LPG 5 | 1516 |
| 205 D | 1.8 | 44 | 09.98 - 12.99 | XUD7 | 4 | █ | Y-938R | 5267 | | D-POWER 1 | 7906 |



ℓ kW



Cyl.

Order-
No. No.LPG/CNG
D-PowerOrder-
No.**PEUGEOT**

| | | | | | | | | | | | |
|--------------------------|-----|----|---------------|----------------|---|-----|---------|------|----|------------|------|
| 205 D | 1.8 | 44 | 10.83 - 08.98 | XUD7 | 4 | █ | Y-924J | 7906 | | D-POWER 1 | 7906 |
| 205 D | 1.9 | 47 | 10.87 - 08.98 | XUD9 | 4 | █ | Y-924J | 7906 | | D-POWER 1 | 7906 |
| 205 Entreprise XA,XRA | 1.6 | | 88 - | E1E / G1E | 4 | 0,7 | BCP6ES | 4930 | 17 | LPG 3 | 1498 |
| 205 Entreprise,XA,XRA | 1.3 | | 88 - | G1 | 4 | 0,7 | BCP6ES | 4930 | 17 | LPG 3 | 1498 |
| 205 Entreprise XA, XRA | 1.1 | | 88 - | E1 | 4 | 0,7 | BCP6ES | 4930 | 17 | LPG 3 | 1498 |
| 205 Gentry | 1.9 | 75 | 07.92 - | XU9.J1 Cat. | 4 | 0,8 | BCPR5ES | 6130 | 32 | LPG 3 | 1498 |
| 205 GL, XL, XE | 0.9 | | -06.87 | XV8 | 4 | 0,8 | BP6EFS | 3812 | 5 | LPG 5 | 1516 |
| 205 GL,XL,XE | 0.9 | 31 | -06.87 | XV.. | 4 | 0,8 | BP6EFS | 3812 | 5 | LPG 5 | 1516 |
| 205 GR,Color Line | 1.1 | 44 | 07.92 - 06.95 | TU1M Cat. | 4 | 0,8 | BCPR5ES | 6130 | 32 | LPG 3 | 1498 |
| 205 GR,Color,Sacre Num | 1.1 | 44 | 03.95 - | TU1.M Cat. | 4 | | BKR6EK | 2288 | 20 | LPG 1 | 1496 |
| 205 GR,XS,XT,Auto | 1.6 | 53 | -06.87 | XU5.1C | 4 | 0,8 | BP6EFS | 3812 | 5 | LPG 5 | 1516 |
| 205 GR,XS,XT,Auto | 1.6 | 58 | 07.87 - 06.90 | XU5.1C | 4 | 0,8 | BCP5ES | 7496 | 16 | LPG 3 | 1498 |
| 205 GR,XS,XT,Auto | 1.6 | | 07.90 - 12.92 | XU5.1C | 4 | 0,7 | BCP6ES | 4930 | 17 | LPG 3 | 1498 |
| 205 GTi | 1.9 | 88 | 07.92 - | XU9.JA Cat. | 4 | 0,8 | BCPR5ES | 6130 | 32 | LPG 3 | 1498 |
| 205 GTi / CTi | 1.6 | 76 | -06.87 | XU5.J / XU5JA | 4 | 0,8 | BP6EFS | 3812 | 5 | LPG 5 | 1516 |
| 205 GTi / CTi | 1.6 | 83 | 07.87 - 06.92 | XU5JA | 4 | 0,7 | BCP6ES | 4930 | 17 | LPG 3 | 1498 |
| 205 GTi / Gentry | 1.9 | 94 | -12.92 | XU9.JA | 4 | 0,7 | BCP6ES | 4930 | 17 | LPG 3 | 1498 |
| 205 Rallye | 1.3 | 75 | 03.88 - 06.92 | TU2.4 | 4 | | BKUR7ET | 7873 | | PFR7Q | 7963 |
| 205 Rallye | 1.4 | | 03.88 - 06.92 | TU2.4 | 4 | | BKUR7ET | 7873 | | PFR7Q | 7963 |
| 205 TD | 1.8 | 58 | 07.85 - 08.98 | XUD7T | 4 | █ | Y-924J | 7906 | | D-POWER 1 | 7906 |
| 205 Turbo 16 Stan. | 1.8 | | 84 - | | 4 | 0,8 | R5724-9 | 6434 | | | |
| 205 XA,XL,XR,GL,GR | 1.1 | 36 | -06.87 | XW7 | 4 | 0,8 | BP6EFS | 3812 | 5 | LPG 5 | 1516 |
| 205 XE,GL,Junior | 0.9 | 33 | 07.87 - 12.92 | TU9 | 4 | 0,8 | BCP5ES | 7496 | 16 | LPG 3 | 1498 |
| 205 XE,GL,Junior | 0.9 | 33 | 07.92 - | TU9M Cat. | 4 | 0,8 | BCPR5ES | 6130 | 32 | LPG 3 | 1498 |
| 205 XR,GR,SR | 1.4 | 44 | -06.87 | XY7 | 4 | 0,8 | BP6EFS | 3812 | 5 | LPG 5 | 1516 |
| 205 XR,GR,SR,CJ | 1.4 | 43 | 07.87 - 12.92 | TU3 , TU3A | 4 | 0,8 | BCP5ES | 7496 | 16 | LPG 3 | 1498 |
| 205 XR,GR,SR,CJ | 1.4 | 55 | 07.92 - | TU3FM Cat. | 4 | 0,8 | BCPR5ES | 6130 | 32 | LPG 3 | 1498 |
| 205 XR,GR,SR,SJ,Sacre N° | 1.4 | 55 | 07.95 - | TU3.MC Cat. | 4 | | BKR6EK | 2288 | 20 | LPG 1 | 1496 |
| 205 XR,XL,GL,GR | 1.1 | 34 | 07.87 - 12.92 | TU1 | 4 | 0,8 | BCP5ES | 7496 | 16 | LPG 3 | 1498 |
| 205 XR,XS | 1.4 | 55 | 07.92 - 06.95 | TU3MC Cat. | 4 | 0,8 | BCPR6ES | 2330 | 12 | LPG 3 | 1498 |
| 205 XS,GT,Auto | 1.6 | 65 | 07.92 - | XU5.M Cat. | 4 | 0,8 | BCPR5ES | 6130 | 32 | LPG 3 | 1498 |
| 205 XT,GT | 1.4 | 58 | -06.87 | XY8 | 4 | 0,8 | BP7EFS | 3526 | | | |
| 205 XT,XS,GT,CT | 1.4 | 62 | 07.87 - 12.92 | TU3S | 4 | 0,7 | BCP6ES | 4930 | 17 | LPG 3 | 1498 |
| 206 | 1.1 | 44 | 09.98 - 12.99 | TU1JP-HFZ,HFY | 4 | | BKR6EK | 2288 | 20 | LPG 1 | 1496 |
| 206 | 1.1 | 44 | 01.00 - | TU1JP-HFZ,HFY | 4 | 0,9 | BKR6EZ | 4619 | 38 | LPG 1 | 1496 |
| 206 | 1.4 | 55 | 01.00 - | TU3JP-KFX | 4 | 0,9 | BKR6EZ | 4619 | 38 | LPG 1 | 1496 |
| 206 | 1.4 | 55 | 09.98 - 12.99 | TU3JP-KFX | 4 | | BKR6EK | 2288 | 20 | LPG 1 | 1496 |
| 206 | 1.6 | 66 | 01.00 - | TU5JP-NFZ | 4 | 0,9 | BKR6EZ | 4619 | 38 | LPG 1 | 1496 |
| 206 | 1.6 | 66 | 09.98 - 08.00 | TU5JP-NFZ | 4 | | BKR6EK | 2288 | 20 | LPG 1 | 1496 |
| 206 & SW | 1.1 | 44 | 01.00 - | TU1JP HFZ, HFY | 4 | 0,9 | BKR6EZ | 4619 | 38 | LPG 1 | 1496 |
| 206 & SW | 1.1 | 44 | 09.98 - 12.99 | TU1JP HFZ, HFY | 4 | | BKR6EK | 2288 | 20 | LPG 1 | 1496 |
| 206 & SW | 1.4 | 51 | 12.04 - | DV4TD | 4 | █ | YE05 | 5207 | | | |
| 206 & SW | 1.4 | 55 | 01.00 - | TU3JP KFX | 4 | 0,9 | BKR6EZ | 4619 | 38 | LPG 1 | 1496 |
| 206 & SW | 1.4 | 55 | 09.98 - 12.99 | TU3JP KFX | 4 | | BKR6EK | 2288 | 20 | LPG 1 | 1496 |
| 206 & SW | 1.4 | 66 | 04 - | ET3J4 KFU | 4 | 0,8 | LZKAR7A | 6799 | | | |
| 206 & SW | 1.6 | 66 | 01.00 - | TU5JP NFZ | 4 | 0,9 | BKR6EZ | 4619 | 38 | LPG 1 | 1496 |
| 206 & SW | 1.6 | 66 | 09.98 - 12.99 | TU5JP NFZ | 4 | | BKR6EK | 2288 | 20 | LPG 1 | 1496 |
| 206 & SW Hdi | 1.4 | 51 | 11.01 - 12.04 | DV4TD | 4 | █ | YE04 | 1684 | | D-POWER 40 | 1684 |
| 206 & SW 16V, CC | 1.6 | 81 | 03.01 - | TU5JP4 NFU | 4 | 0,9 | LFR6B | 6677 | | LPG 7 | 1640 |
| 206 & SW Hdi | 1.4 | 51 | 09.01 - 12.04 | DV4TD | 4 | █ | YE04 | 1684 | | D-POWER 40 | 1684 |
| 206 & SW Hdi | 1.6 | 81 | 04 - 06.06 | DV6TED4 | 4 | █ | YE04 | 1684 | | D-POWER 40 | 1684 |
| 206 & SW Hdi | 2.0 | 66 | 10.99 - | DW10TD | 4 | █ | Y-504R | 4359 | | D-POWER 24 | 1441 |



ℓ kW



Cyl.

Order-
No.VLINE
No.LPG/CNG
D-PowerOrder-
No.**PEUGEOT**

| | | | | | | | | | | | |
|----------------------|-----|-----|--------------|--------------------|---|-----|------------|------|----|------------|------|
| 206 & SW S16, GT, CC | 2.0 | 101 | 04.99 - | EW10J4-RFR, RFN | 4 | 0,9 | LFR5B | 7113 | | LPG 7 | 1640 |
| 206 16V CC | 1.6 | 81 | 03.01 - | TU5JP4-NFU | 4 | 0,9 | LFR6B | 6677 | | LPG 7 | 1640 |
| 206 2.0 S16 RC | 2.0 | 132 | 10.02 - | EW10J4S- RFK | 4 | 0,9 | LFR6B | 6677 | | LPG 7 | 1640 |
| 206 Coupé 16V | 2.0 | 102 | 04.99 - | EW10J4 | 4 | 0,9 | LFR5B | 7113 | | LPG 7 | 1640 |
| 206 Coupé 16V XS, XT | 1.6 | 81 | 03.01 - | TU5JP4 | 4 | 0,9 | LFR6B | 6677 | | LPG 7 | 1640 |
| 206 D | 1.9 | 51 | 09.98 - | DW8/ DW8B | 4 | █ | Y-503R | 4279 | | D-POWER 10 | 1009 |
| 206 S16 | 2.0 | 132 | 10.02 - | EW10J4S RFK | 4 | 0,9 | LFR6B | 6677 | | LPG 7 | 1640 |
| 206 S16,GT,CC | 2.0 | 101 | 04.99 - | EW10J4 | 4 | 0,9 | LFR5B | 7113 | | LPG 7 | 1640 |
| 207 & SW | 1.6 | 66 | 06.07 - | DV6TD | 4 | █ | YE05 | 5207 | | | |
| 207 & SW | 1.6 | 80 | 06.07 - | DV6TED4 | 4 | █ | YE05 | 5207 | | | |
| 207 | 1.4 | 55 | 05.06 - | TU3A-KFV | 4 | 0,9 | BKR6EZ | 4619 | 38 | LPG 1 | 1496 |
| 207 1.4 16V | 1.4 | 70 | 07 - | EP3 | 4 | 0,8 | PLZKBR7A-G | 5843 | | PLZKBR7A-G | 5843 |
| 207 1.6 16V | 1.6 | 110 | 07 - | EP6DT | 4 | 0,8 | PLZKBR7A-G | 5843 | | PLZKBR7A-G | 5843 |
| 207 16V | 1.4 | 55 | 07 - | EP3 | 4 | 0,8 | PLZKBR7A-G | 5843 | | PLZKBR7A-G | 5843 |
| 207 16V | 1.4 | 66 | 04.06 - | ET3J4-KFU | 4 | 0,8 | LZKAR7A | 6799 | | | |
| 207 16V | 1.6 | 75 | 04.06 - | EP6 | 4 | 0,8 | PLZKBR7A-G | 5843 | | PLZKBR7A-G | 5843 |
| 207 | 1.6 | 110 | 07 - | EP6DT | 4 | 0,8 | PLZKBR7A-G | 5843 | | PLZKBR7A-G | 5843 |
| 207 | 1.6 | 129 | 11.06 - | EP6DTS | 4 | 0,8 | PLZKBR7A-G | 5843 | | PLZKBR7A-G | 5843 |
| 207 Hdi | 1.4 | 51 | 07.06 - | DV4TD | 4 | █ | YE04 | 1684 | | D-POWER 40 | 1684 |
| 207 Hdi | 1.6 | 66 | 07.06 - | DV6TD | 4 | █ | YE04 | 1684 | | D-POWER 40 | 1684 |
| 207 Hdi | 1.6 | 81 | 07.06 - | DV6 | 4 | █ | YE05 | 5207 | | | |
| 207 Hdi 16V | 1.6 | 81 | 07.06 - | DV6TED4 | 4 | █ | YE04 | 1684 | | D-POWER 40 | 1684 |
| 207 RC | 1.6 | 129 | 04.07 - | EP6DTS | 4 | 0,8 | PLZKBR7A-G | 5843 | | PLZKBR7A-G | 5843 |
| 3008 Hdi | 2.0 | 80 | 06.09 - | DW10CTED4 | 4 | █ | Y8001AS | 8904 | | D-POWER 58 | 8904 |
| 3008 Hdi 16V | 1.6 | 80 | 04.09 - | DV6CTED4 9HZ | 4 | █ | Y8001AS | 8904 | | D-POWER 58 | 8904 |
| 3008 Hdi 16V | 2.0 | 110 | 04.09 - | DW10CTED4 RHE, RHH | 4 | █ | Y8001AS | 8904 | | D-POWER 58 | 8904 |
| 3008 THP | 1.6 | 110 | 05.09 - | EP6DT | 4 | 0,8 | PLZKBR7A-G | 5843 | | PLZKBR7A-G | 5843 |
| 3008 THP | 1.6 | 115 | 05.09 - | EP6DT | 4 | 0,8 | PLZKBR7A-G | 5843 | | PLZKBR7A-G | 5843 |
| 3008 Vti | 1.6 | 88 | 05.09 - | EP6 | 4 | 0,8 | PLZKBR7A-G | 5843 | | PLZKBR7A-G | 5843 |
| 305 D | 1.6 | 32 | 07.81 -10.83 | XID | 4 | █ | Y-924J | 7906 | | D-POWER 1 | 7906 |
| 305 D | 1.8 | 44 | 10.82 -06.88 | XUD7 | 4 | █ | Y-924J | 7906 | | D-POWER 1 | 7906 |
| 305 D | 1.9 | 47 | 10.82 -06.88 | XUD 9 | 4 | █ | Y-924J | 7906 | | D-POWER 1 | 7906 |
| 305 GL,GR | 1.3 | 44 | -06.87 | XL5 | 4 | 0,8 | BP6EFS | 3812 | 5 | LPG 5 | 1516 |
| 305 GL,SR | 1.5 | 54 | -06.87 | XR5 | 4 | 0,8 | BP6EFS | 3812 | 5 | LPG 5 | 1516 |
| 305 GR,SR | 1.6 | 58 | -06.87 | XU5.1C | 4 | 0,8 | BP6EFS | 3812 | 5 | LPG 5 | 1516 |
| 305 GR,SR | 1.6 | 58 | 07.87 -07.90 | XU5.1C | 4 | 0,8 | BCP5ES | 7496 | 16 | LPG 3 | 1498 |
| 305 GT | 1.6 | 50 | -06.87 | XU5S | 4 | 0,8 | BP6EFS | 3812 | 5 | LPG 5 | 1516 |
| 305 GTX | 1.9 | 75 | 07.86 -06.87 | XU9.2C | 4 | 0,8 | BP6EFS | 3812 | 5 | LPG 5 | 1516 |
| 305 GTX | 1.9 | 75 | 07.87 -07.90 | XU9.2C | 4 | 0,8 | BCP5ES | 7496 | 16 | LPG 3 | 1498 |
| 305 GTX | 1.9 | 75 | 07.84 -07.86 | XU9S | 4 | 0,8 | BP6EFS | 3812 | 5 | LPG 5 | 1516 |
| 305 S | 1.5 | 50 | -06.87 | XR5S | 4 | 0,8 | BP6EFS | 3812 | 5 | LPG 5 | 1516 |
| 306 | 1.1 | 44 | 02.93 -06.95 | TU1M-HDZ | 4 | 0,8 | BCPR5ES | 6130 | 32 | LPG 3 | 1498 |
| 306 | 1.1 | 44 | 07.95 -04.97 | TU1M-HDZ | 4 | | BKR5EK | 7956 | 23 | LPG 1 | 1496 |
| 306 | 1.1 | | 96 - | TU1.M+ | 4 | | BKR6EK | 2288 | 20 | LPG 1 | 1496 |
| 306 | 1.4 | 55 | 02.93 -06.95 | TU3.MC-KDX | 4 | 0,8 | BCPR5ES | 6130 | 32 | LPG 3 | 1498 |
| 306 | 1.4 | 55 | 01.00 -10.03 | TU3JP-KFX | 4 | 0,9 | BKR6EZ | 4619 | 38 | LPG 1 | 1496 |
| 306 | 1.4 | 55 | 07.95 -12.03 | TU3JP-KFX | 4 | | BKR6EK | 2288 | 20 | LPG 1 | 1496 |
| 306 | 1.6 | 66 | 01.00 -10.03 | TU5JP-NFZ | 4 | 0,9 | BKR6EZ | 4619 | 38 | LPG 1 | 1496 |
| 306 | 1.6 | 66 | 02.93 -12.99 | TU5JP-NFZ | 4 | | BKR6EK | 2288 | 20 | LPG 1 | 1496 |
| 306 | 1.8 | 43 | 10.93 -08.98 | XUD7 | 4 | █ | Y-924J | 7906 | | D-POWER 1 | 7906 |
| 306 | 1.8 | 44 | 09.98 - | XUD7 | 4 | █ | Y-938R | 5267 | | D-POWER 1 | 7906 |
| 306 | 1.8 | 74 | 04.95 -10.03 | XU7JP-LFZ | 4 | | BKR5EK | 7956 | 23 | LPG 1 | 1496 |



ℓ kW



Cyl.

Order-
No. No.LPG/CNG
D-PowerOrder-
No.**PEUGEOT**

| | | | | | | | | | | | |
|---------------------|-----|-----|---------------|---------------|---|-----|------------|------|----|------------|------|
| 306 | 1.9 | 51 | 09.98 - 07.02 | DW8 | 4 | █ | Y-503R | 4279 | | D-POWER 10 | 1009 |
| 306 | 1.9 | 51 | 09.98 - 12.99 | XUD9A/XUD9BSD | 4 | █ | Y-938R | 5267 | | D-POWER 1 | 7906 |
| 306 | 2.0 | 89 | 02.93 - 03.95 | XU10.J2-RFX | 4 | 0,8 | BCPR5ES | 6130 | 32 | LPG 3 | 1498 |
| 306 | 2.0 | 89 | 04.95 - 04.97 | XU10.J2-RFX | 4 | | BKR5EK | 7956 | 23 | LPG 1 | 1496 |
| 306 | 2.0 | 89 | - 03.97 | XU10.J4-RFY | 4 | 0,8 | BKR6ES | 3783 | 28 | LPG 1 | 1496 |
| 306 | 2.0 | 98 | 04.97 - | XU10J4R-RFV | 4 | | BKR5EK | 7956 | 23 | LPG 1 | 1496 |
| 306 | 2.0 | 120 | 07.96 - 10.03 | XU10J4RS-RFS | 4 | 0,9 | BKR5EZ | 7642 | 36 | LPG 1 | 1496 |
| 306 / Cabrio | 1.8 | 74 | 02.93 - 03.95 | XU7JP-LFZ | 4 | 0,8 | BCPR5ES | 6130 | 32 | LPG 3 | 1498 |
| 306 16V | 1.8 | 81 | 04.97 - 10.03 | XU7JP4-LFY | 4 | | BKR5EK | 7956 | 23 | LPG 1 | 1496 |
| 306 2.0 16V Le Mans | 2.0 | | 11.93 - 96 | XU10J4 | 4 | 0,8 | BKR6ES | 3783 | 28 | LPG 1 | 1496 |
| 306 D | 1.8 | 44 | 09.98 - 07.02 | DW8 | 4 | █ | Y-503R | 4279 | | D-POWER 10 | 1009 |
| 306 D | 1.9 | 51 | 02.93 - 08.98 | XUD9A | 4 | █ | Y-924J | 7906 | | D-POWER 1 | 7906 |
| 306 D | 1.9 | 68 | 03.93 - 08.98 | XUD9TE | 4 | █ | Y-923U | 3380 | | D-POWER 1 | 7906 |
| 306 D | 1.9 | 68 | 09.98 - 12.99 | XUD9TE | 4 | █ | Y-938R | 5267 | | D-POWER 1 | 7906 |
| 306 D | 2.0 | 80 | 09.98 - | DW10TD | 4 | █ | Y-504R | 4359 | | D-POWER 24 | 1441 |
| 306 Hdi | 2.0 | 66 | 04.99 - 07.02 | DW10TD | 4 | █ | Y-504R | 4359 | | D-POWER 24 | 1441 |
| 306 Le Mans | 2.0 | 110 | 11.93 - 96 | XU10J4 | 4 | 0,8 | BKR6ES | 3783 | 28 | LPG 1 | 1496 |
| 306 TD | 1.8 | 59 | 09.98 - 07.02 | DW8TD | 4 | █ | Y-503R | 4279 | | D-POWER 10 | 1009 |
| 307 | 1.4 | 55 | 04.01 - 05.05 | TU3JP-KFX | 4 | 0,9 | BKR6EZ | 4619 | 38 | LPG 1 | 1496 |
| 307 | 1.6 | 81 | 04.01 - | TU5JP4-NFU | 4 | 0,9 | LFR6B | 6677 | | LPG 7 | 1640 |
| 307 | 2.0 | 101 | 04.01 - | EW10J4-RFN | 4 | 0,9 | LFR5B | 7113 | | LPG 7 | 1640 |
| 307 & SW | 1.4 | 51 | 12.04 - 05.05 | DV4TD | 4 | █ | YE05 | 5207 | | | |
| 307 & SW | 2.0 | 104 | 09.06 - | EW10A | 4 | 0,9 | LFR5B | 7113 | | LPG 7 | 1640 |
| 307 & SW Hdi | 2.0 | 66 | 04.01 - | DW10TD | 4 | █ | Y-504R | 4359 | | D-POWER 24 | 1441 |
| 307 & SW Hdi | 2.0 | 81 | 09.01 - | DW10ATED | 4 | █ | Y-504R | 4359 | | D-POWER 24 | 1441 |
| 307 & SW XR | 1.4 | 55 | 04.01 - 99 | TU3JP KFX | 4 | 0,9 | BKR6EZ | 4619 | 38 | LPG 1 | 1496 |
| 307 & SW 16V | 1.4 | 66 | 03.04 - | ET3J4 KFU | 4 | 0,8 | LZKAR7A | 6799 | | | |
| 307 & SW 16V | 1.6 | 81 | 04.01 - | TU5JP4 NFU | 4 | 0,9 | LFR6B | 6677 | | LPG 7 | 1640 |
| 307 & SW 16V | 2.0 | 101 | 04.01 - | EW10J4-RFN | 4 | 0,9 | LFR5B | 7113 | | LPG 7 | 1640 |
| 307 & SW Hdi | 1.4 | 51 | 01.02 - 12.04 | DV4TD | 4 | █ | YE04 | 1684 | | D-POWER 40 | 1684 |
| 307 & SW Hdi | 1.6 | 68 | 07.06 - | DV6TD | 4 | █ | YE04 | 1684 | | D-POWER 40 | 1684 |
| 307 & SW Hdi | 1.6 | 81 | 07.06 - | | 4 | █ | YE05 | 5207 | | | |
| 307 & SW Hdi | 1.6 | 81 | 07.06 - | DV6 | 4 | █ | YE05 | 5207 | | | |
| 307 & SW Hdi | 1.6 | 81 | 03.04 - 06.06 | DV6TED4 | 4 | █ | YE04 | 1684 | | D-POWER 40 | 1684 |
| 307 & SW Hdi | 2.0 | 100 | 03.04 - | DW10TED | 4 | █ | Y-504R | 4359 | | D-POWER 24 | 1441 |
| 307 2.0 16V SW | 2.0 | 104 | 09.06 - | EW10A | 4 | 0,9 | LFR5B | 7113 | | LPG 7 | 1640 |
| 307 CC Hdi | 2.0 | 100 | 11.03 - 04.09 | DW10BTED4 | 4 | █ | Y1005J | 7957 | | D-POWER 56 | 7957 |
| 307 Coupé 16V | 2.0 | 102 | 03 - | EW10J4 | 4 | 0,9 | LFR5B | 7113 | | LPG 7 | 1640 |
| 307 Hdi | 1.4 | 51 | 01.02 - 12.04 | DV4TD | 4 | █ | YE04 | 1684 | | D-POWER 40 | 1684 |
| 307 Hdi | 2.0 | 100 | 11.03 - 11.07 | DW10BTED4 | 4 | █ | Y1005J | 7957 | | D-POWER 56 | 7957 |
| 307 SW Hdi | 2.0 | 100 | 11.03 - 04.08 | DW10BTED4 | 4 | █ | Y1005J | 7957 | | D-POWER 56 | 7957 |
| 308 1.4 16V | 1.4 | 55 | 09.07 - | EP3 | 4 | 0,8 | PLZKBR7A-G | 5843 | | PLZKBR7A-G | 5843 |
| 308 1.6 16V | 1.6 | 80 | 09.07 - | EP6 | 4 | 0,8 | PLZKBR7A-G | 5843 | | PLZKBR7A-G | 5843 |
| 308 1.6 Hdi | 1.6 | 66 | 09.07 - | DV6TD | 4 | █ | YE05 | 5207 | | | |
| 308 1.6 Hdi | 1.6 | 80 | | DV6CTED4 | 4 | █ | Y8001AS | 8904 | | D-POWER 58 | 8904 |
| 308 1.6 Hdi 16V FAP | 1.6 | 81 | 09.07 - | DV6TED4 | 4 | █ | YE05 | 5207 | | | |
| 308 1.6 THP 150 | 1.6 | 110 | 09.07 - | EP6DT | 4 | 0,8 | PLZKBR7A-G | 5843 | | PLZKBR7A-G | 5843 |
| 308 1.6 THP 175 | 1.6 | 130 | 09.07 - | EP6DTS | 4 | 0,8 | PLZKBR7A-G | 5843 | | PLZKBR7A-G | 5843 |
| 308 CC 1.6 THP 16V | 1.6 | 105 | 03.09 - | EP6DT | 4 | 0,8 | PLZKBR7A-G | 5843 | | PLZKBR7A-G | 5843 |
| 308 CC 1.6 THP 16V | 1.6 | 110 | 03.09 - | EP6DT | 4 | 0,8 | PLZKBR7A-G | 5843 | | PLZKBR7A-G | 5843 |
| 308 Hdi | 2.0 | 100 | 09.07 - | DW10BTED4 | 4 | █ | Y1005J | 7957 | | D-POWER 56 | 7957 |
| 309 | 1.5 | 42 | 03.94 - 12.95 | TUD5 | 4 | █ | Y-503J | 1009 | | D-POWER 10 | 1009 |



ℓ kW

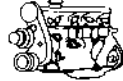

Cyl.

Order-
No.VLINE
No.LPG/CNG
D-PowerOrder-
No.**PEUGEOT**

| | | | | | | | | | | | |
|--------------------------------|-----|-----|---------------|-------------------|---|-----|---------|------|----|-----------|------|
| 309 | 1.9 | 75 | 03.86 - 07.89 | XU9.J1 Cat. | 4 | 0,8 | BCPR5ES | 6130 | 32 | LPG 3 | 1498 |
| 309 D | 1.8 | 44 | 06.86 - 12.93 | XUD7 | 4 | █ | Y-924J | 7906 | | D-POWER 1 | 7906 |
| 309 D | 1.9 | 47 | 06.86 - 12.93 | XUD9 / XUD9Y | 4 | █ | Y-924J | 7906 | | D-POWER 1 | 7906 |
| 309 GE, GL, GR, XE, XL, XR, XA | 1.3 | 47 | 10.86 - 12.93 | G1A | 4 | 0,8 | BCP5ES | 7496 | 16 | LPG 3 | 1498 |
| 309 GE, GL, GR | 1.1 | 40 | - 12.92 | E1A | 4 | 0,8 | BCP5ES | 7496 | 16 | LPG 3 | 1498 |
| 309 GR, GRX, SR, SX, XS, XR | 1.6 | 68 | 07.89 - 12.92 | XU5.2C | 4 | 0,7 | BCP6ES | 4930 | 17 | LPG 3 | 1498 |
| 309 GR, SR | 1.6 | 53 | - 06.87 | XU5.1C | 4 | 0,8 | BP6EFS | 3812 | 5 | LPG 5 | 1516 |
| 309 GR, SR | 1.6 | 53 | 07.87 - 06.89 | XU5.1C | 4 | 0,8 | BCP5ES | 7496 | 16 | LPG 3 | 1498 |
| 309 GRX | 1.4 | 55 | 10.86 - 12.93 | TU3M Cat. | 4 | 0,8 | BCPR5ES | 6130 | 32 | LPG 3 | 1498 |
| 309 GT | 1.9 | 75 | - 06.87 | XU9.2C | 4 | 0,8 | BP6EFS | 3812 | 5 | LPG 5 | 1516 |
| 309 GT | 1.9 | 75 | 07.87 - 06.89 | XU9.2C | 4 | 0,8 | BCP5ES | 7496 | 16 | LPG 3 | 1498 |
| 309 GTi | 1.9 | 88 | 07.92 - | XU9.JA Cat. | 4 | 0,8 | BCPR5ES | 6130 | 32 | LPG 3 | 1498 |
| 309 GTi | 1.9 | 94 | - 12.92 | XU9.JA | 4 | 0,7 | BCP6ES | 4930 | 17 | LPG 3 | 1498 |
| 309 GTi 16V | 1.9 | 110 | 07.92 - | XU9.J4 Cat. | 4 | | BCPR6ET | 2197 | | LPG 3 | 1498 |
| 309 GTi 16V | 1.9 | 118 | - 06.92 | XU9.J4 | 4 | | BCP6ET | 4563 | | LPG 3 | 1498 |
| 309 SR, GRX | 1.6 | 65 | 07.92 - | XU5M Cat. | 4 | 0,8 | BCPR5ES | 6130 | 32 | LPG 3 | 1498 |
| 309 TD | 1.8 | 58 | 11.89 - 12.93 | XUD7T | 4 | █ | Y-924J | 7906 | | D-POWER 1 | 7906 |
| 309 Vital | 1.1 | 40 | 07.92 - | TU1M Cat. | 4 | 0,8 | BCPR5ES | 6130 | 32 | LPG 3 | 1498 |
| 309 XA, XR, XL | 1.1 | 40 | - 12.92 | E1A | 4 | 0,8 | BCP5ES | 7496 | 16 | LPG 3 | 1498 |
| 309 XE, GE | 1.1 | 40 | - 12.92 | TU1 | 4 | 0,8 | BCP5ES | 7496 | 16 | LPG 3 | 1498 |
| 309 XL, GL | 1.4 | 44 | 10.86 - 12.93 | TU3 | 4 | 0,8 | BCP5ES | 7496 | 16 | LPG 3 | 1498 |
| 309 XS, SX | 1.9 | 80 | 07.89 - 06.92 | XU9.2C | 4 | 0,7 | BCP6ES | 4930 | 17 | LPG 3 | 1498 |
| 309 XS, SX | 1.9 | 80 | 07.92 - | XU9M Cat. | 4 | 0,8 | BCPR5ES | 6130 | 32 | LPG 3 | 1498 |
| 4007 2.2 Hdi | 2.2 | 115 | 07.07 - | DW12MTED4 | 4 | █ | YE08 | 4966 | | | |
| 4007 Hdi | 2.2 | 115 | 07.07 - | DW12MTED4 | 4 | █ | YE08 | 4966 | | | |
| 405 | 1.4 | 55 | 07.95 - 04.97 | TU3M-KDX Cat. | 4 | | BKR6EK | 2288 | 20 | LPG 1 | 1496 |
| 405 | 1.6 | 66 | 04.95 - | XU5JP-BFZ | 4 | | BKR5EK | 7956 | 23 | LPG 1 | 1496 |
| 405 | 1.8 | | 04.95 - | XU7JP-LFZ | 4 | | BKR5EK | 7956 | 23 | LPG 1 | 1496 |
| 405 | 1.9 | 51 | 09.98 - 12.99 | XUD9A | 4 | █ | Y-938R | 5267 | | D-POWER 1 | 7906 |
| 405 | 1.9 | 55 | 10.95 - | XUD9SD | 4 | █ | Y-923U | 3380 | | D-POWER 1 | 7906 |
| 405 D | 1.9 | 51 | 03.88 - | XUD9A | 4 | █ | Y-924J | 7906 | | D-POWER 1 | 7906 |
| 405 GL | 1.4 | 47 | 07.87 - 06.92 | TU3 | 4 | 0,8 | BCP5ES | 7496 | 16 | LPG 3 | 1498 |
| 405 GL | 1.4 | 55 | 07.92 - 06.95 | TU3M-KDX Cat. | 4 | 0,8 | BCPR5ES | 6130 | 32 | LPG 3 | 1498 |
| 405 GL, GR, SR | 1.6 | 55 | 07.87 - 06.92 | XU51C | 4 | 0,8 | BCP5ES | 7496 | 16 | LPG 3 | 1498 |
| 405 GL, GR, SR | 1.6 | 65 | 07.92 - 06.94 | XU5M-BDY Cat. | 4 | 0,8 | BCPR5ES | 6130 | 32 | LPG 3 | 1498 |
| 405 GLD | 1.9 | 47 | 07.88 - 12.92 | XUD9Y | 4 | █ | Y-924J | 7906 | | D-POWER 1 | 7906 |
| 405 GR, SR | 1.9 | | 07.87 - 06.92 | XU92C | 4 | 0,7 | BCP6ES | 4930 | 17 | LPG 3 | 1498 |
| 405 GRi, SRi, Si, X4 | 1.9 | | 07.87 - 06.92 | XU9J2-D6A | 4 | 0,7 | BCP6ES | 4930 | 17 | LPG 3 | 1498 |
| 405 Mi16 | 2.0 | 110 | 07.92 - | XU10J4-RFY Cat. | 4 | 0,8 | BKR6ES | 3783 | 28 | LPG 1 | 1496 |
| 405 Mi16, X4 | 1.9 | 116 | 07.87 - 06.90 | XU9J4-D6C | 4 | | BCP6ET | 4563 | | LPG 3 | 1498 |
| 405 MI16, X4 | 1.9 | | 07.90 - 06.92 | XU9J4-D6C | 4 | | BCPR6ET | 2197 | | LPG 3 | 1498 |
| 405 Signa, Style | 1.8 | 74 | 07.92 - 03.95 | XU7JP-LFZ Cat. | 4 | 0,8 | BCPR5ES | 6130 | 32 | LPG 3 | 1498 |
| 405 Signature, STI | 2.0 | 90 | 07.92 - 03.95 | XU10J2-RFX Cat. | 4 | | BKR5EK | 7956 | 23 | LPG 1 | 1496 |
| 405 Signature, STI | 2.0 | | 07.92 - 03.95 | XU10J2-RFX Cat. | 4 | 0,8 | BCPR5ES | 6130 | 32 | LPG 3 | 1498 |
| 405 Sillage, Style | 1.6 | | 07.94 - 03.95 | XU5JP-BFZ Cat. | 4 | 0,8 | BCPR5ES | 6130 | 32 | LPG 3 | 1498 |
| 405 T16 | 2.0 | 147 | 09.92 - 04.97 | XU10J4TE-RGZ Cat. | 4 | | BKR6EK | 2288 | 20 | LPG 1 | 1496 |
| 405 TD | 1.8 | 68 | 03.88 - 12.92 | XUD7TE | 4 | █ | Y-924J | 7906 | | D-POWER 1 | 7906 |
| 405 TD | 1.9 | 68 | 09.92 - 12.97 | XUD9TE / XUD9TF | 4 | █ | Y-923U | 3380 | | D-POWER 1 | 7906 |
| 406 | 1.6 | 66 | 10.95 - 06.04 | XU5JP-BFZ | 4 | | BKR5EK | 7956 | 23 | LPG 1 | 1496 |
| 406 | 1.8 | 66 | 10.95 - 06.04 | XU7JP-L6A | 4 | | BKR5EK | 7956 | 23 | LPG 1 | 1496 |
| 406 | 1.8 | 81 | 10.95 - 06.04 | XU7JP4-LFY | 4 | | BKR5EK | 7956 | 23 | LPG 1 | 1496 |
| 406 | 1.9 | 68 | 09.98 - 12.99 | XUD9TE / TF/BTF | 4 | █ | Y-938R | 5267 | | D-POWER 1 | 7906 |



ℓ kW



Cyl.

Order-
No. No.LPG/CNG
D-PowerOrder-
No.**PEUGEOT**

| | | | | | | | | | | | |
|-----------------|-----|-----|---------------|----------------------|---|-----|-----------|------|----|------------|------|
| 406 | 2.0 | 97 | 10.95 - 06.04 | XU10J4R-RFV | 4 | | BKR5EK | 7956 | 23 | LPG 1 | 1496 |
| 406 | 2.0 | 107 | 07.96 - 03.99 | XU10J2TE-RGX | 4 | | BKR6EK | 2288 | 20 | LPG 1 | 1496 |
| 406 | 2.1 | 80 | 09.98 - 12.99 | XUD11BTE | 4 | ■ | Y-938R | 5267 | | D-POWER 1 | 7906 |
| 406 24V V6 | 3.0 | 140 | 10.96 - 02.05 | ES9J4-XFZ | 6 | | BKR6EK | 2288 | 20 | LPG 1 | 1496 |
| 406 Coupé 16V | 2.0 | 97 | 06.97 - 03.99 | XU10J4R-RFV | 4 | | BKR5EK | 7956 | 23 | LPG 1 | 1496 |
| 406 Coupé 16V | 2.0 | 101 | 04.99 - 02.05 | EW10J4-RFR | 4 | 0,9 | LFR5B | 7113 | | LPG 7 | 1640 |
| 406 Coupé 16V | 2.2 | 118 | 05.00 - 02.05 | EW12J4-3FZ | 4 | 0,9 | LFR5B | 7113 | | LPG 7 | 1640 |
| 406 Coupé V6 | 3.0 | 143 | 06.97 - 02.05 | ES9J4-XFZ | 6 | | BKR6EK | 2288 | 20 | LPG 1 | 1496 |
| 406 Coupé V6 | 3.0 | 154 | 06.00 - 11.04 | ES9J4S-XFX | 6 | 1,1 | PLFR5A-11 | 6240 | | LPG 7 | 1640 |
| 406 Coupe Hdi | 2.2 | 98 | 09.00 - 12.04 | DW12TED4 | 4 | ■ | Y1005J | 7957 | | D-POWER 56 | 7957 |
| 406 Coupé Hdi | 2.2 | 100 | 03.01 - | DW12TED4 | 4 | ■ | Y-504R | 4359 | | D-POWER 24 | 1441 |
| 406 Hdi | 2.0 | 81 | 12.98 - 04.04 | DW10ATED | 4 | ■ | Y-504R | 4359 | | D-POWER 24 | 1441 |
| 406 Hdi | 2.2 | 98 | 03.00 - 10.04 | DW12TED4 | 4 | ■ | Y1005J | 7957 | | D-POWER 56 | 7957 |
| 406 Hdi Phase 2 | 2.2 | 100 | 09.00 - 05.03 | DW12TED4 | 4 | ■ | Y-504R | 4359 | | D-POWER 24 | 1441 |
| 406 Phase 2 | 1.8 | 66 | 04.99 - 02.05 | XU7JB-LFX | 4 | | BKR6EK | 2288 | 20 | LPG 1 | 1496 |
| 406 Phase 2 | 1.8 | 81 | 04.99 - 06.04 | XU7JP4-LFY | 4 | | BKR5EK | 7956 | 23 | LPG 1 | 1496 |
| 406 Phase 2 | 1.8 | 86 | 09.00 - 06.04 | EW7J4-6FZ | 4 | 0,9 | LFR5B | 7113 | | LPG 7 | 1640 |
| 406 Phase 2 | 2.0 | 101 | 04.99 - 02.05 | EW10J4-RFR, RFN | 4 | 0,9 | LFR5B | 7113 | | LPG 7 | 1640 |
| 406 Phase 2 | 2.2 | 117 | 04.99 - 02.05 | EW12J4-3FZ | 4 | 0,9 | LFR5B | 7113 | | LPG 7 | 1640 |
| 406 Phase 2 | 3.0 | 140 | 04.99 - 02.05 | ES9J4-XFZ | 6 | | BKR6EK | 2288 | 20 | LPG 1 | 1496 |
| 406 Phase 2 | 3.0 | 154 | 10.00 - 02.05 | ES9J4S-XFX | 6 | 1,1 | PLFR5A-11 | 6240 | | LPG 7 | 1640 |
| 406 TD | 1.9 | 68 | 10.95 - 08.98 | XUD9TE/TF/BTF | 4 | ■ | Y-923U | 3380 | | D-POWER 1 | 7906 |
| 406 TD | 2.1 | 80 | 10.95 - 08.98 | XUD11BTE | 4 | ■ | Y-923U | 3380 | | D-POWER 1 | 7906 |
| 406 TD Phase 2 | 2.0 | 66 | 04.99 - 04.04 | DW10TD | 4 | ■ | Y-504R | 4359 | | D-POWER 24 | 1441 |
| 406 TD Phase 2 | 2.0 | 81 | 04.99 - 04.04 | DW10ATED | 4 | ■ | Y-504R | 4359 | | D-POWER 24 | 1441 |
| 407 16V | 2.0 | 104 | 09.06 - | EW10A | 4 | 0,9 | LFR5B | 7113 | | LPG 7 | 1640 |
| 407 2.0 16V | 2.0 | | 09.06 - | EW10A | 4 | 0,9 | LFR5B | 7113 | | LPG 7 | 1640 |
| 407 3.0 V6 24V | 3.0 | | 04.04 - | ES9A XFV | 6 | 1,1 | PLFR5A-11 | 6240 | | LPG 7 | 1640 |
| 407 Coupe Hdi | 2.0 | 100 | 08.05 - 05.09 | DW10BTED4 | 4 | ■ | Y1005J | 7957 | | D-POWER 56 | 7957 |
| 407 Hdi | 1.6 | 81 | 04.04 - 06.06 | DV6TED | 4 | ■ | YE04 | 1684 | | D-POWER 40 | 1684 |
| 407 Hdi | 1.6 | 81 | 03.06 - | DV6TED4 | 4 | ■ | YE05 | 5207 | | | |
| 407 Hdi | 2.0 | 93 | 04.04 - | DW10TED | 4 | ■ | Y-504R | 4359 | | D-POWER 24 | 1441 |
| 407 Hdi | 2.2 | 125 | 05.06 - | DW12BTED4 | 4 | ■ | YE08 | 4966 | | | |
| 407 V6 | 3.0 | 155 | 04.04 - | ES9A XFV | 6 | 1,1 | PLFR5A-11 | 6240 | | LPG 7 | 1640 |
| 408 Hdi | 2.0 | 110 | 10 - | DW10CTED4 | 4 | ■ | Y8001AS | 8904 | | D-POWER 58 | 8904 |
| 5008 Hdi | 1.6 | 80 | 09.09 - | DV6CTED4 | 4 | ■ | Y8001AS | 8904 | | D-POWER 58 | 8904 |
| 5008 Hdi | 2.0 | 110 | 07.09 - | DW10CTED4 | 4 | ■ | Y8001AS | 8904 | | D-POWER 58 | 8904 |
| 5008 Hdi | 2.0 | 110 | 09.09 - | DW10CTED4 | 4 | ■ | Y8001AS | 8904 | | D-POWER 58 | 8904 |
| 5008 Hdi | 2.0 | 121 | 09.09 - | DW10CTED4 | 4 | ■ | Y8001AS | 8904 | | D-POWER 58 | 8904 |
| 504 | | | - 83 | Carburettor/Vergaser | 4 | 0,8 | BP5ES | 6511 | 8 | LPG 2 | 1497 |
| 504 | 1.9 | | 05.81 - 06.87 | XD4.88 | 4 | ■ | Y-924J | 7906 | | D-POWER 1 | 7906 |
| 504 D | 2.1 | 43 | 05.81 - 09.81 | XD 4.90 | 4 | ■ | Y-924J | 7906 | | D-POWER 1 | 7906 |
| 504 D | 2.3 | 47 | 05.81 - 06.83 | XD 2 | 4 | ■ | Y-924J | 7906 | | D-POWER 1 | 7906 |
| 504 D Pick Up | 2.3 | 47 | 07.84 - 12.90 | XD 2 | 4 | ■ | Y-924J | 7906 | | D-POWER 1 | 7906 |
| 505 D | 2.5 | 51 | 06.87 - 12.93 | XD 3 | 4 | ■ | Y-924J | 7906 | | D-POWER 1 | 7906 |
| 505 GL,SR,ST,SX | 1.8 | 62 | 10.85 - 12.93 | XN.. / XM.. | 4 | 0,7 | BP6ES | 7811 | 4 | LPG 2 | 1497 |
| 505 GTi | 2.2 | | 05.81 - 12.93 | ZAJ | 4 | 0,8 | BP6EFS | 3812 | 5 | LPG 5 | 1516 |
| 505 TD | 2.3 | 54 | 09.80 - 06.86 | XD 2 S | 4 | ■ | Y-208T | 1250 | | | |
| 505 TD | 2.5 | 66 | 10.83 - 12.93 | XD 3 T | 4 | ■ | Y-924J | 7906 | | D-POWER 1 | 7906 |
| 505 TD | 2.5 | 77 | 10.86 - 12.93 | XD 3 TE | 4 | ■ | Y-924J | 7906 | | D-POWER 1 | 7906 |
| 505 Ti,STi | 2.0 | 81 | 07.85 - 12.89 | ZEJ | 4 | 0,8 | BP6EFS | 3812 | 5 | LPG 5 | 1516 |
| 505 Turbo | 2.2 | 105 | - 10.88 | N9T | 4 | 0,6 | BR7ES | 5122 | | BR8EIX | 5044 |



ℓ kW

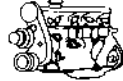

Cyl.

Order-
No. No.LPG/CNG
D-PowerOrder-
No.**PEUGEOT**

| | | | | | | | | | | | |
|----------------|-----|-----|---------------|-----------------|---|-----|-----------|------|----|------------|------|
| 505 Turbo | 2.2 | 110 | 03.84 - 10.88 | N9TE | 4 | | BP6ET | 1263 | | LPG 2 | 1497 |
| 505 V6 | 2.8 | 105 | 08.86 - 12.93 | ZN3J | 6 | 0,6 | BR7EF | 3346 | | | |
| 604 | 2.3 | | 05.81 - 06.83 | XD2S | 4 | █ | Y-924J | 7906 | | D-POWER 1 | 7906 |
| 604 TD | 2.5 | 66 | 07.83 - 06.86 | XD 3 T | 4 | █ | Y-924J | 7906 | | D-POWER 1 | 7906 |
| 604 V6 | 2.8 | 106 | -06.86 | ZNJ/K | 6 | 0,8 | BP6EFS | 3812 | 5 | LPG 5 | 1516 |
| 605 | 2.0 | 99 | 08.94 - 05.99 | XU10J4R-RFV | 4 | | BKR5EK | 7956 | 23 | LPG 1 | 1496 |
| 605 3.0 | 3.0 | 140 | 07.97 - 05.99 | ES9J4-XFZ | 6 | | BKR6EK | 2288 | 20 | LPG 1 | 1496 |
| 605 D | 2.1 | 60 | 09.89 - 06.94 | XUD11A/L | 4 | █ | Y-924J | 7906 | | D-POWER 1 | 7906 |
| 605 SL | 2.0 | 79 | 07.89 - 06.92 | XU102C-R2A | 4 | 0,7 | BCP6ES | 4930 | 17 | LPG 3 | 1498 |
| 605 SLI | 2.0 | 89 | 07.92 - 07.94 | XU10J2-RFZ Cat. | 4 | 0,8 | BCPR5ES | 6130 | 32 | LPG 3 | 1498 |
| 605 SR, SV | 3.0 | 125 | 07.89 - 06.97 | ZPJ-SFZ Cat. | 6 | | BCPR6ET | 2197 | | LPG 3 | 1498 |
| 605 SRi | 2.0 | 89 | 09.89 - 12.92 | XU10J2-R6A | 4 | 0,8 | BCPR6ES | 2330 | 12 | LPG 3 | 1498 |
| 605 SRTi Turbo | 2.0 | 104 | 12.92 - 05.99 | XU10J2TE-RGX | 4 | | BKR6EK | 2288 | 20 | LPG 1 | 1496 |
| 605 SV 24V | 3.0 | 147 | 07.89 - 06.97 | ZPJ4-SKZ Cat. | 6 | | BCPR6ET | 2197 | | LPG 3 | 1498 |
| 605 TD | 2.1 | 80 | 09.98 - 07.00 | XUD11ATE/BTE | 4 | █ | Y-938R | 5267 | | D-POWER 1 | 7906 |
| 605 TD | 2.1 | 80 | 09.89 - 06.94 | XUD11ATE/L, BTE | 4 | █ | Y-923U | 3380 | | D-POWER 1 | 7906 |
| 605 TD | 2.5 | 96 | 07.94 - 05.99 | DK5ATE | 4 | █ | Y-923U | 3380 | | D-POWER 1 | 7906 |
| 607 | 2.0 | 101 | 05.00 - 11.04 | EW10J4-RFN | 4 | 0,9 | LFR5B | 7113 | | LPG 7 | 1640 |
| 607 | 2.2 | 118 | 05.00 - | EW12J4-3FZ | 4 | 0,9 | LFR5B | 7113 | | LPG 7 | 1640 |
| 607 3.0 V6 | 3.0 | 152 | 05.00 - | ES9J4S-XFX | 6 | 1,1 | PLFR5A-11 | 6240 | | LPG 7 | 1640 |
| 607 Hdi | 2.0 | 81 | | DW10TED | 4 | █ | Y-504R | 4359 | | D-POWER 24 | 1441 |
| 607 Hdi | 2.0 | 100 | 09.05 - | DW10BTED4 | 4 | █ | Y1005J | 7957 | | D-POWER 56 | 7957 |
| 607 Hdi | 2.2 | 125 | 06.06 - | DW12BTED4 | 4 | █ | YE08 | 4966 | | | |
| 607 Hdi | 2.2 | 98 | 12.99 - 02.06 | DW12TED4 | 4 | █ | Y1005J | 7957 | | D-POWER 56 | 7957 |
| 607 Hdi | 2.7 | 150 | 12.04 - | DT17 | 6 | █ | YE12 | 7794 | | | |
| 607 Hdi 16V | 2.2 | 100 | 05.00 - | DW12TED4 | 4 | █ | Y-504R | 4359 | | D-POWER 24 | 1441 |
| 806 | 1.8 | 74 | 10.96 - 06.00 | XU7JP-LFW | 4 | | BKR5EK | 7956 | 23 | LPG 1 | 1496 |
| 806 | 2.0 | 90 | 04.95 - 05.00 | XU10J2-RFU | 4 | | BKR5EK | 7956 | 23 | LPG 1 | 1496 |
| 806 | 2.0 | 101 | 06.00 - | EW10J4-RFR | 4 | 0,9 | LFR5B | 7113 | | LPG 7 | 1640 |
| 806 16V | 2.0 | 89 | 06.94 - 03.95 | XU10J2-RFU | 4 | 0,8 | BCPR5ES | 6130 | 32 | LPG 3 | 1498 |
| 806 D | 1.9 | 68 | 09.98 - | XUD9BTF | 4 | █ | Y-938R | 5267 | | D-POWER 1 | 7906 |
| 806 D | 1.9 | 68 | 09.98 - 01.01 | XUD9TF | 4 | █ | Y-938R | 5267 | | D-POWER 1 | 7906 |
| 806 D | 2.0 | 80 | 09.98 - | DW10TED | 4 | █ | Y-504R | 4359 | | D-POWER 24 | 1441 |
| 806 D | 2.1 | 80 | 06.96 - 08.98 | XUD11BTE | 4 | █ | Y-923U | 3380 | | D-POWER 1 | 7906 |
| 806 D | 2.1 | 80 | 09.98 - 01.01 | XUD11BTE | 4 | █ | Y-938R | 5267 | | D-POWER 1 | 7906 |
| 806 D Hdi | 2.0 | 81 | 09.99 - | DW10ATED | 4 | █ | Y-504R | 4359 | | D-POWER 24 | 1441 |
| 806 TD | 1.9 | 68 | 06.94 - 08.98 | XUD9TF | 4 | █ | Y-923U | 3380 | | D-POWER 1 | 7906 |
| 806 TD | 2.1 | 80 | 07.96 - | XUD11ATE | 4 | █ | Y-923U | 3380 | | D-POWER 1 | 7906 |
| 806 Turbo | 2.0 | 110 | 06.94 - 05.00 | XU10J2TE-RGX | 4 | | BKR6EK | 2288 | 20 | LPG 1 | 1496 |
| 807 | 2.0 | 102 | 06.02 - 09.05 | EW10J4-RFR | 4 | 0,9 | LFR5B | 7113 | | LPG 7 | 1640 |
| 807 | 2.0 | 104 | 10.05 - | EW10A | 4 | 0,9 | LFR5B | 7113 | | LPG 7 | 1640 |
| 807 | 2.2 | 118 | 06.02 - | EW12J4-3FZ | 4 | 0,9 | LFR5B | 7113 | | LPG 7 | 1640 |
| 807 | 3.0 | 154 | 06.02 - | ES9J4S-XFX | 6 | 1,1 | PLFR5A-11 | 6240 | | LPG 7 | 1640 |
| 807 Hdi | 2.0 | 80 | 06.02 - | DW10ATED4/RHT | 4 | █ | Y-504R | 4359 | | D-POWER 24 | 1441 |
| 807 Hdi | 2.2 | 94 | 06.02 - | DW12TED4/4HW | 4 | █ | Y-504R | 4359 | | D-POWER 24 | 1441 |
| 807 2.0 16V | 2.0 | | 10.05 - | EW10A | 4 | 0,9 | LFR5B | 7113 | | LPG 7 | 1640 |
| 807 Hdi | 2.0 | 100 | 06.06 - | DW10BTED4 | 4 | █ | Y1005J | 7957 | | D-POWER 56 | 7957 |
| 807 Hdi | 2.0 | 79 | 08.02 - 05.06 | DW10ATED4 | 4 | █ | Y1005J | 7957 | | D-POWER 56 | 7957 |
| 807 Hdi | 2.0 | 80 | 04.04 - 05.06 | DW10ATED4 | 4 | █ | Y1005J | 7957 | | D-POWER 56 | 7957 |
| 807 Hdi | 2.0 | 88 | 11.06 - | DW10UTED4 | 4 | █ | Y1005J | 7957 | | D-POWER 56 | 7957 |
| 807 Hdi | 2.2 | 94 | 08.02 - 05.06 | DW12TED4 | 4 | █ | Y1005J | 7957 | | D-POWER 56 | 7957 |
| Bipper Hdi | | 55 | 02.08 - | DV4 | 4 | █ | YE05 | 5207 | | | |



ℓ kW



Cyl.

Order-
No. No.LPG/CNG
D-PowerOrder-
No.**PEUGEOT**

| | | | | | | | | | | | |
|------------------|-----|-----|---------------|--------------------|---|-----|---------|------|----|------------|------|
| Boxer | 1.9 | 68 | 09.98 - | XUD9TF | 4 | █ | Y-938R | 5267 | | D-POWER 1 | 7906 |
| Boxer | 2.0 | 81 | -03.95 | XU10J2U-RFW | 4 | 0,8 | BCPR6ES | 2330 | 12 | LPG 3 | 1498 |
| Boxer | 2.0 | 81 | 04.95 - | XU10J2U-RFW | 4 | | BKR6EK | 2288 | 20 | LPG 1 | 1496 |
| Boxer | 2.5 | 63 | 03.94 - 08.98 | DJ5 | 4 | █ | Y-923U | 3380 | | D-POWER 1 | 7906 |
| Boxer Hdi | 2.2 | 74 | 12.01 - 06.06 | DW12UTED | 4 | █ | Y1005J | 7957 | | D-POWER 56 | 7957 |
| Boxer Hdi | 2.8 | 93 | 10.97 - | Sofim | 4 | █ | Y-924U | 4950 | | D-POWER 1 | 7906 |
| Boxer 2 Hdi | 2.0 | 66 | 09.98 - | DW10TD | 4 | █ | Y-504R | 4359 | | D-POWER 24 | 1441 |
| Boxer 2 Hdi | 2.2 | 100 | 03.01 - | DW10TED4 | 4 | █ | Y-504R | 4359 | | D-POWER 24 | 1441 |
| Boxer D | 1.8 | 44 | 09.98 - | XUD7 | 4 | █ | Y-938R | 5267 | | D-POWER 1 | 7906 |
| Boxer D | 1.9 | 51 | 03.94 - 08.98 | XUD9A | 4 | █ | Y-923U | 3380 | | D-POWER 1 | 7906 |
| Boxer D | 1.9 | 51 | 09.98 - | XUD9AU | 4 | █ | Y-938R | 5267 | | D-POWER 1 | 7906 |
| Boxer TD | 1.9 | 68 | 03.94 - 08.98 | XUD9TF | 4 | █ | Y-923U | 3380 | | D-POWER 1 | 7906 |
| Boxer TD | 2.5 | 76 | 03.94 - 08.96 | DJ5T | 4 | █ | Y-923U | 3380 | | D-POWER 1 | 7906 |
| Boxer Tdi | 2.5 | 76 | 09.96 - | DJ5TED | 4 | █ | Y-738U | 5390 | | | |
| Expert | 1.6 | 59 | 95 - | 1580 SPI 222A2.000 | 4 | 0,8 | BCPR7ES | 3330 | | BCPR7EIX | 5690 |
| Expert | 1.8 | 44 | 09.98 - | DW8 | 4 | █ | Y-503R | 4279 | | D-POWER 10 | 1009 |
| Expert | 1.8 | 74 | 96 - | XU7JP | 4 | | BKR5EK | 7956 | 23 | LPG 1 | 1496 |
| Expert | 1.9 | 51 | 01.96 - 08.98 | XUD9A | 4 | █ | Y-923U | 3380 | | D-POWER 1 | 7906 |
| Expert | 1.9 | 51 | 09.98 - | XUD9A | 4 | █ | Y-938R | 5267 | | D-POWER 1 | 7906 |
| Expert | 1.9 | 68 | 01.96 - 08.98 | XUD9BTF | 4 | █ | Y-923U | 3380 | | D-POWER 1 | 7906 |
| Expert | 1.9 | 68 | 01.96 - 08.98 | XUD9TF | 4 | █ | Y-923U | 3380 | | D-POWER 1 | 7906 |
| Expert | 2.0 | 101 | 06.00 - | EW10J4-RFN | 4 | 0,9 | LFR5B | 7113 | | LPG 7 | 1640 |
| Expert | 2.0 | 104 | 01.07 - | EW10A | 4 | 0,9 | LFR5B | 7113 | | LPG 7 | 1640 |
| Expert | 2.1 | 80 | 07.96 - | XUD11ATE | 4 | █ | Y-923U | 3380 | | D-POWER 1 | 7906 |
| Expert Hdi | 2.0 | 70 | 02.00 - | DW10TED | 4 | █ | Y-504R | 4359 | | D-POWER 24 | 1441 |
| Expert Hdi | 2.0 | 81 | 02.00 - | DW10ATED | 4 | █ | Y-504R | 4359 | | D-POWER 24 | 1441 |
| Expert Hdi | 2.0 | 100 | 11.06 - | DW10BTED4 | 4 | █ | Y1005J | 7957 | | D-POWER 56 | 7957 |
| Expert Hdi | 2.0 | 88 | 11.06 - | DW10UTED4 | 4 | █ | Y1005J | 7957 | | D-POWER 56 | 7957 |
| Expert 2.0 16V | 2.0 | 105 | 01.07 - | EW10A | 4 | 0,9 | LFR5B | 7113 | | LPG 7 | 1640 |
| Expert TD | 1.8 | 59 | 09.98 - | DW8TD | 4 | █ | Y-503R | 4279 | | D-POWER 10 | 1009 |
| Expert TD | 1.9 | 66 | 09.95 - 08.98 | XUD 9TE | 4 | █ | Y-923U | 3380 | | D-POWER 1 | 7906 |
| Expert TD | 1.9 | 68 | 09.98 - | XUD9BTF | 4 | █ | Y-938R | 5267 | | D-POWER 1 | 7906 |
| Expert TD | 1.9 | 68 | 09.98 - | XUD9TF | 4 | █ | Y-938R | 5267 | | D-POWER 1 | 7906 |
| J5 | 1.9 | 51 | 11.87 - 01.94 | XUD9A | 4 | █ | Y-924J | 7906 | | D-POWER 1 | 7906 |
| J5 | 2.5 | 54 | 07.91 - 03.94 | CRD93 | 4 | █ | Y-924J | 7906 | | D-POWER 1 | 7906 |
| J5 | 2.5 | 70 | 07.91 - 03.94 | CRD93LS | 4 | █ | Y-924J | 7906 | | D-POWER 1 | 7906 |
| J5 D | 1.9 | 51 | 11.87 - | XUD9A | 4 | █ | Y-924J | 7906 | | D-POWER 1 | 7906 |
| J5 D | 2.5 | 54 | 09.81 - 06.91 | CRD93 | 4 | █ | Y-208T | 1250 | | | |
| J5 TD | 2.5 | 70 | 07.87 - 06.91 | CRD93LS | 4 | █ | Y-208T | 1250 | | | |
| J9 Transporter D | | 59 | 05.81 - | | 4 | █ | Y-924J | 7906 | | D-POWER 1 | 7906 |
| J9 Transporter D | | 59 | 10.80 - 04.81 | | 4 | █ | Y-208T | 1250 | | | |
| J9 Transporter D | 2.1 | 41 | 10.80 - 04.81 | XDP 4.90 | 4 | █ | Y-208T | 1250 | | | |
| J9 Transporter D | 2.1 | 41 | 05.81 - | XDP4.90 | 4 | █ | Y-924J | 7906 | | D-POWER 1 | 7906 |
| J9 Transporter D | 2.1 | 41 | 10.80 - 10.82 | XDP4.90 | 4 | █ | Y-208T | 1250 | | | |
| J9 Transporter D | 2.3 | 48 | 10.80 - 10.82 | XD2P | 4 | █ | Y-208T | 1250 | | | |
| J9 Transporter D | 2.5 | 53 | 10.80 - 10.82 | XD3P | 4 | █ | Y-208T | 1250 | | | |
| J9 Transporter D | 2.5 | 53 | 10.82 - | XD3P | 4 | █ | Y-924J | 7906 | | D-POWER 1 | 7906 |
| Partner | 1.1 | 44 | 07.96 - | TU1M+HDZ | 4 | | BKR6EK | 2288 | 20 | LPG 1 | 1496 |
| Partner | 1.4 | 55 | 07.96 - | TU3JP-KFX/KFW | 4 | | BKR6EK | 2288 | 20 | LPG 1 | 1496 |
| Partner | 1.8 | 66 | 07.97 - | XU7JB-LFX | 4 | | BKR6EK | 2288 | 20 | LPG 1 | 1496 |
| Partner Combi | 1.8 | 43 | 07.96 - 08.98 | XUD7 | 4 | █ | Y-923U | 3380 | | D-POWER 1 | 7906 |
| Partner Combi | 1.8 | 44 | 09.98 - 03.02 | XUD7 | 4 | █ | Y-938R | 5267 | | D-POWER 1 | 7906 |



ℓ kW



Cyl.

Order-
No.V-LINE
No.LPG/CNG
D-PowerOrder-
No.**PEUGEOT**

| | | | | | | | | | | | |
|------------------------|-----|----|-------------|---------------|---|-----|--------|------|----|------------|------|
| Partner Combi | 1.8 | 59 | 09.98-03.02 | DW8TD | 4 | █ | Y-503R | 4279 | | D-POWER 10 | 1009 |
| Partner Combi | 1.9 | 51 | 09.98-03.02 | XUD9A | 4 | █ | Y-938R | 5267 | | D-POWER 1 | 7906 |
| Partner Combi | 1.8 | 44 | 09.98-03.02 | DW8 | 4 | █ | Y-503R | 4279 | | D-POWER 10 | 1009 |
| Partner Combi | 1.9 | 51 | 09.98-03.02 | DW8 / DW8B | 4 | █ | Y-503R | 4279 | | D-POWER 10 | 1009 |
| Partner Combi | 1.9 | 51 | 07.96-08.98 | XUD9A | 4 | █ | Y-923U | 3380 | | D-POWER 1 | 7906 |
| Partner Combi Hdi | 2.0 | 66 | 10.99-03.02 | DW10TD | 4 | █ | Y-504R | 4359 | | D-POWER 24 | 1441 |
| Partner Hdi | 1.4 | 55 | 03.06- | DV6 | 4 | █ | YE05 | 5207 | | | |
| Partner Hdi | 1.6 | 66 | 03.06- | DV6 | 4 | █ | YE05 | 5207 | | | |
| Partner Multispace | 1.4 | 55 | 01.97-12.99 | TU3JP-KFX/KFW | 4 | | BKR6EK | 2288 | 20 | LPG 1 | 1496 |
| Partner Multispace | 1.4 | 55 | 01.00- | TU3JP-KFX/KFW | 4 | 0,9 | BKR6EZ | 4619 | 38 | LPG 1 | 1496 |
| Partner Multispace | 1.6 | 81 | 02.01- | TU5JP4-NFU | 4 | 0,9 | LFR6B | 6677 | | LPG 7 | 1640 |
| Partner Multispace | 1.8 | 66 | 07.97- | XU7JB-LFX | 4 | | BKR6EK | 2288 | 20 | LPG 1 | 1496 |
| Partner Multispace | 1.9 | 51 | 09.98- | DW8 / DW8B | 4 | █ | Y-503R | 4279 | | D-POWER 10 | 1009 |
| Partner Multispace | 1.9 | 51 | 01.97-09.98 | XUD9A | 4 | █ | Y-923U | 3380 | | D-POWER 1 | 7906 |
| Partner Multispace Hdi | 2.0 | 66 | 10.99- | DW10TD | 4 | █ | Y-504R | 4359 | | D-POWER 24 | 1441 |

PIAGGIO

| | | | | | | | | | | | |
|-----------------|------|----|--------|-------|---|-----|---------|------|--|-----------|------|
| Ape Car D | 0.5 | 11 | 01.83- | | | █ | Y-918J | 6285 | | D-POWER 2 | 6285 |
| Ape 50 | 0.05 | | | | 1 | 0,7 | BR7HS | 4122 | | BR8HIX | 7001 |
| Ape TM 200 | 0.20 | | | | 1 | 0,6 | B6HS | 4510 | | BR7HIX | 7067 |
| Porter 1.3i 16V | 1.3 | 48 | 05.98- | HC-ES | 4 | | BKUR6EK | 2213 | | | |

PLYMOUTH

| | | | | | | | | | | | |
|--------|-----|--|--------|---------------|--|-----|------|------|--|--|--|
| Breeze | 2.0 | | 96- | L4 MPI C SOHC | | 0,9 | FR5 | 4876 | | | |
| Breeze | 2.0 | | 96- 99 | L4 MPI X DOHC | | 1,2 | FR45 | 4636 | | | |
| Neon | 2.0 | | 95- | L4 MPI C SOHC | | 0,9 | FR5 | 4876 | | | |
| Neon | 2.0 | | 95- | L4 MPI Y DOHC | | 0,9 | FR5 | 4876 | | | |

PONTIAC

| | | | | | | | | | | | |
|------------|-----|--|--------|----------------|---|-----|----------|------|--|-------|------|
| Bonneville | 3.8 | | 80- | A 2 bbl CID231 | 6 | 1,5 | UR45 | 2451 | | UR5IX | 7177 |
| Bonneville | 3.8 | | 81- 83 | A 2 bbl CID231 | 6 | 2,0 | UR40 | 4386 | | | |
| Bonneville | 3.8 | | 98- 99 | V6 MFI 1 SC | 6 | 1,5 | PTR4B-15 | 5146 | | LPG 5 | 1516 |
| Bonneville | 3.8 | | 96- 99 | V6 MFI K | 6 | 1,5 | PTR4B-15 | 5146 | | LPG 5 | 1516 |
| Bonneville | 3.8 | | 96- 97 | V6 SFI 1 SC | 6 | 1,5 | PTR4B-15 | 5146 | | LPG 5 | 1516 |
| Bonneville | 4.1 | | 82- | 4 4 bbl CID252 | 6 | 2,0 | UR40 | 4386 | | | |
| Bonneville | 4.3 | | 80- 81 | S 2 bbl CID265 | 8 | 1,5 | UR45 | 2451 | | UR5IX | 7177 |
| Bonneville | 5.0 | | 83- | H 4 bbl CID305 | 8 | 1,1 | UR4 | 4762 | | UR5IX | 7177 |
| Bonneville | 5.0 | | 81- | Y 4 bbl CID307 | 8 | 1,5 | XR40 | 2990 | | | |
| Bonneville | 5.7 | | 80- | R 4 bbl CID350 | 8 | 1,5 | XR40 | 2990 | | | |
| Catalina | 3.8 | | 81- | A 2 bbl CID231 | 6 | 2,0 | UR40 | 4386 | | | |
| Catalina | 3.8 | | 80- | K 2 bbl CID229 | 6 | 1,1 | UR4 | 4762 | | UR5IX | 7177 |
| Catalina | 4.3 | | 80- 81 | S 2 bbl CID265 | 8 | 1,5 | UR45 | 2451 | | UR5IX | 7177 |
| Catalina | 4.4 | | 80- 81 | J 2 bbl CID267 | 8 | 1,1 | UR4 | 4762 | | UR5IX | 7177 |
| Catalina | 5.0 | | 80- 81 | H 4 bbl CID305 | 8 | 1,1 | UR4 | 4762 | | UR5IX | 7177 |
| Catalina | 5.0 | | 81- | Y 4 bbl CID307 | 8 | 1,5 | XR40 | 2990 | | | |
| Catalina | 5.7 | | 80- | R 4 bbl CID350 | 8 | 1,5 | XR40 | 2990 | | | |
| Firebird | 2.8 | | 82- 83 | 1 2 bbl CID173 | 6 | 1,3 | UR5 | 2139 | | UR6IX | 7348 |
| Firebird | 2.8 | | 83- | L 2 bbl CID173 | 6 | 1,3 | UR5 | 2139 | | UR6IX | 7348 |
| Firebird | 3.8 | | 81- | A 2 bbl CID231 | 6 | 2,0 | UR40 | 4386 | | | |
| Firebird | 3.8 | | 96- 99 | V6 MFI K | 6 | 1,5 | PTR4B-15 | 5146 | | LPG 5 | 1516 |
| Firebird | 4.3 | | 80- 81 | S 2 bbl CID265 | 8 | 1,5 | UR45 | 2451 | | UR5IX | 7177 |
| Firebird | 4.4 | | 81- | J 2 bbl CID267 | 8 | 1,1 | UR4 | 4762 | | UR5IX | 7177 |



ℓ kW



Cyl.

Order-
No. No.LPG/CNG
D-PowerOrder-
No.**PONTIAC**

| | | | | | | | | | | | |
|----------------|-----|-----|-------------|----------------|---|-----|----------|------|----|-------|------|
| Firebird | 4.9 | | 80 - 81 | T 4 bbl CID301 | 8 | 1,5 | UR45 | 2451 | | UR5IX | 7177 |
| Firebird | 5.0 | | 82 - 83 | 7 EFI CID305 | 8 | 1,1 | UR4 | 4762 | | UR5IX | 7177 |
| Firebird | 5.0 | | 80 - 83 | H 4 bbl CID305 | 8 | 1,1 | UR4 | 4762 | | UR5IX | 7177 |
| Firebird | 5.0 | | 83 - | S EFI CID305 | 8 | 1,1 | UR4 | 4762 | | UR5IX | 7177 |
| Grand Prix | 3.1 | | 94 - 95 | V6 MFI M | 6 | 1,5 | TR55 | 1048 | | LPG 5 | 1516 |
| Grand Prix | 3.4 | | 91 - 95 | V6 MFI X | 6 | 1,0 | TR5 | 2238 | | LPG 5 | 1516 |
| Grand Prix | 3.8 | | 81 - 83 | A 2 bbl CID231 | 6 | 2,0 | UR40 | 4386 | | | |
| Grand Prix | 3.8 | | 97 - | V6 MFI 1 SC | 6 | 1,5 | PTR4B-15 | 5146 | | LPG 5 | 1516 |
| Grand Prix | 3.8 | | 98 - | V6 MFI 1 SC | 6 | 1,5 | PTR4B-15 | 5146 | | LPG 5 | 1516 |
| Grand Prix | 3.8 | | 97 - | V6 MFI K | 6 | 1,5 | PTR4B-15 | 5146 | | LPG 5 | 1516 |
| Grand Prix | 4.1 | | 82 - | 4 4 bbl CID252 | 6 | 2,0 | UR40 | 4386 | | | |
| Grand Prix | 4.3 | | 80 - 81 | S 2 bbl CID265 | 8 | 1,5 | UR45 | 2451 | | UR5IX | 7177 |
| Grand Prix | 4.4 | | 81 - 82 | J 2 bbl CID267 | 8 | 1,1 | UR4 | 4762 | | UR5IX | 7177 |
| GTO | 5.7 | | 05 - | V8 | 8 | 1,5 | TR55 | 1048 | | LPG 5 | 1516 |
| Trans Sport | 2.3 | 101 | 01.93-03.97 | L4 16V G | 4 | 0,8 | BCPR6ES | 2330 | 12 | LPG 3 | 1498 |
| Trans Sport V6 | 3.1 | | 90 - 95 | V6 SFI D | 6 | 1,3 | UR5 | 2139 | | UR6IX | 7348 |
| Trans Sport V6 | 3.4 | | 96 - | V6 MFI E | 6 | 1,5 | TR55 | 1048 | | LPG 5 | 1516 |
| Trans Sport V6 | 3.8 | | 01.92 - 93 | V6 MFI L | 6 | 1,5 | TR55 | 1048 | | LPG 5 | 1516 |
| Trans Sport V6 | 3.8 | | 94 - 95 | V6 SFI L | 6 | 1,5 | TR55 | 1048 | | LPG 5 | 1516 |

PORSCHE

| | | | | | | | | | | | |
|-------------------------------|-----|-----|---------|--------|---|-----|----------|------|----|----------|------|
| 911 Carrea (997) | 3.6 | 239 | 04 - | M96.05 | 6 | | BKR7EQUP | 4285 | | | |
| 911 Carrea S (997) | 3.8 | 261 | 04 - | M97.01 | 6 | | BKR7EQUP | 4285 | | | |
| 911 Carrera | 3.2 | 160 | 89 - 89 | 930.21 | 6 | 0,7 | BR8EVX | 1262 | | BR9EIX | 3981 |
| 911 Carrera | 3.2 | 160 | 89 - 89 | 930.25 | 6 | 0,7 | BR8EVX | 1262 | | BR9EIX | 3981 |
| 911 Carrera | 3.2 | 170 | 84 - 89 | 930.20 | 6 | 0,7 | BR8EVX | 1262 | | BR9EIX | 3981 |
| 911 Carrera | 3.2 | 170 | 84 - 89 | 930.26 | 6 | 0,7 | BR8EVX | 1262 | | BR9EIX | 3981 |
| 911 Carrera (993) | 3.8 | 210 | 96 - 96 | M64.05 | 6 | | BCPR7ET | 2164 | | BCPR7EIX | 5690 |
| 911 Carrera (993) | 3.8 | 210 | 96 - 96 | M64.06 | 6 | | BCPR7ET | 2164 | | BCPR7EIX | 5690 |
| 911 Carrera (996) | 3.4 | 221 | 98 - 98 | M96.01 | 6 | | BKR6EQUP | 3199 | 30 | LPG 1 | 1496 |
| 911 Carrera (996) | 3.6 | 235 | 01 - 03 | M96.03 | 6 | | BKR7EQUP | 4285 | | | |
| 911 Carrera (993) | 3.6 | 200 | 94 - 95 | M64.05 | 6 | | BCPR7ET | 2164 | | BCPR7EIX | 5690 |
| 911 Carrera (993) | 3.6 | 200 | 94 - 95 | M64.06 | 6 | | BCPR7ET | 2164 | | BCPR7EIX | 5690 |
| 911 Carrera (993) | 3.6 | 200 | 93 - 97 | M64.07 | 6 | | BCPR7ET | 2164 | | BCPR7EIX | 5690 |
| 911 Carrera (993) | 3.6 | 200 | 93 - 97 | M64.08 | 6 | | BCPR7ET | 2164 | | BCPR7EIX | 5690 |
| 911 Carrera (993) | 3.6 | 200 | 93 - 97 | M64.23 | 6 | | BCPR7ET | 2164 | | BCPR7EIX | 5690 |
| 911 Carrera (993) | 3.6 | 200 | 93 - 97 | M64.24 | 6 | | BCPR7ET | 2164 | | BCPR7EIX | 5690 |
| 911 Carrera (993) | 3.6 | 210 | 97 - 97 | M64.21 | 6 | | BCPR7ET | 2164 | | BCPR7EIX | 5690 |
| 911 Carrera (993) | 3.6 | 210 | 97 - 97 | M64.22 | 6 | | BCPR7ET | 2164 | | BCPR7EIX | 5690 |
| 911 Carrera 2 (996) | 3.4 | 221 | 99 - 00 | M96.01 | 6 | | BKR6EQUP | 3199 | 30 | LPG 1 | 1496 |
| 911 Carrera 2 (996) | 3.4 | 221 | 01 - 04 | M96.04 | 6 | | BKR6EQUP | 3199 | 30 | LPG 1 | 1496 |
| 911 Carrera 2 (964) | 3.6 | 184 | 90 - 93 | M64.01 | 6 | | BCPR7ET | 2164 | | BCPR7EIX | 5690 |
| 911 Carrera 2 (964) | 3.6 | 184 | 90 - 93 | M64.02 | 6 | | BCPR7ET | 2164 | | BCPR7EIX | 5690 |
| 911 Carrera 2 (993) | 3.6 | 184 | 94 - 95 | M64.01 | 6 | | BCPR7ET | 2164 | | BCPR7EIX | 5690 |
| 911 Carrera 2 (993) | 3.6 | 184 | 94 - 95 | M64.02 | 6 | | BCPR7ET | 2164 | | BCPR7EIX | 5690 |
| 911 Carrera 2 CUP (964) | 3.6 | 195 | 90 - 90 | M30... | 6 | | BCPR7ET | 2164 | | BCPR7EIX | 5690 |
| 911 Carrera 2 Speedster (993) | 3.6 | 184 | 94 - 94 | M64.01 | 6 | | BCPR7ET | 2164 | | BCPR7EIX | 5690 |
| 911 Carrera 2 Speedster (993) | 3.6 | 184 | 94 - 94 | M64.02 | 6 | | BCPR7ET | 2164 | | BCPR7EIX | 5690 |
| 911 Carrera 4 (993) | 3.8 | 210 | 96 - 96 | M64.05 | 6 | | BCPR7ET | 2164 | | BCPR7EIX | 5690 |
| 911 Carrera 4 (996) | 3.4 | 221 | 99 - 00 | M96.02 | 6 | | BKR6EQUP | 3199 | 30 | LPG 1 | 1496 |
| 911 Carrera 4 (996) | 3.4 | 221 | 01 - 00 | M96.04 | 6 | | BKR6EQUP | 3199 | 30 | LPG 1 | 1496 |
| 911 Carrera 4 (964) | 3.6 | 184 | 90 - 93 | M64.01 | 6 | | BCPR7ET | 2164 | | BCPR7EIX | 5690 |



ℓ kW

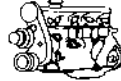

Cyl.

Order-
No.VLINE
No.LPG/CNG
D-PowerOrder-
No.**PORSCHE**

| | | | | | | | | | | | |
|--------------------------------|-----|-----|---------------|------------------|---|-----|-----------|------|----|----------|------|
| 911 Carrera 4 (993) | 3.6 | 200 | 95 - 95 | M64.05 | 6 | | BCPR7ET | 2164 | | BCPR7EIX | 5690 |
| 911 Carrera 4 (993) | 3.6 | 210 | 97 - 98 | M64.21 | 6 | | BCPR7ET | 2164 | | BCPR7EIX | 5690 |
| 911 Carrera 4 S (993) | 3.6 | 210 | 97 - 98 | M64.21 | 6 | | BCPR7ET | 2164 | | BCPR7EIX | 5690 |
| 911 Carrera 4 Turbo Look (993) | 3.6 | 184 | 94 - 94 | M64.01 | 6 | | BCPR7ET | 2164 | | BCPR7EIX | 5690 |
| 911 Carrera 4s (993) | 3.6 | 221 | 96 - 96 | M64.21 | 6 | | BCPR7ET | 2164 | | BCPR7EIX | 5690 |
| 911 Carrera CLUBSPORT | 3.2 | 170 | 87 - 87 | 930.20 | 6 | 0,7 | BR8EVX | 1262 | | BR9EIX | 3981 |
| 911 Carrera RS (964) | 3.6 | 191 | 92 - 92 | M64.03 | 6 | | BCPR7ET | 2164 | | BCPR7EIX | 5690 |
| 911 Carrera RS America (993) | 3.8 | 221 | 95 - 96 | M64.20 | 6 | | BCPR7ET | 2164 | | BCPR7EIX | 5690 |
| 911 Carrera RS America (964) | 3.6 | 184 | 92 - 92 | M64.01 | 6 | | BCPR7ET | 2164 | | BCPR7EIX | 5690 |
| 911 Carrera S (993) | 3.6 | 210 | 97 - 98 | M64.21 | 6 | | BCPR7ET | 2164 | | BCPR7EIX | 5690 |
| 911 Carrera S (993) | 3.6 | 210 | 97 - 98 | M64.22 | 6 | | BCPR7ET | 2164 | | BCPR7EIX | 5690 |
| 911 GT2 (996) | 3.6 | 340 | 01 - 04 | M96.70S | 6 | | BKR7EKC | 7354 | | | |
| 911 GT2 (993) | 3.6 | 316 | 96 - 98 | M64.60R | 6 | | BKR6EK | 2288 | 20 | LPG 1 | 1496 |
| 911 GT3 (996) | 3.6 | 265 | 00 - 00 | M96.76 | 6 | | BKR6EK | 2288 | 20 | | |
| 911 GT3 (996) | 3.6 | 280 | 01 - 04 | M96.76/ M 96.79 | 6 | 0,7 | BKR7EIX | 2667 | | BKR8EIX | 2668 |
| 911 SC | 3.0 | 138 | 80 - 80 | 930.09 | 6 | 0,8 | B9EVX | 7254 | | BR10EIX | 6801 |
| 911 SC | 3.0 | 150 | 81 - 83 | 930.10 | 6 | 0,7 | BR8EVX | 1262 | | BR9EIX | 3981 |
| 911 Speedster | 3.2 | 160 | 89 - 89 | 930.25 | 6 | 0,7 | BR8EVX | 1262 | | BR9EIX | 3981 |
| 911 Turbo | 3.3 | 221 | 81 - 89 | 930.66 | 6 | 0,6 | BP8EVX | 2671 | | BPR9EIX | 6853 |
| 911 Turbo (996) | 3.6 | 309 | 01 - 06 | M96.70 | 6 | | BCPR7ET | 2164 | | BCPR7EIX | 5690 |
| 911 Turbo (964) | 3.3 | 236 | 91 - 92 | M30.69 | 6 | 0,8 | BPR8EIX | 6684 | | BPR9EIX | 6853 |
| 911 Turbo Biturbo (993) | 3.6 | 300 | 95 - 97 | M64.60 | 6 | | BKR6EK | 2288 | 20 | LPG 1 | 1496 |
| 911 Turbo 3,6 (964) | 3.6 | 265 | 93 - 93 | M64.50 | 6 | | BKR6EK | 2288 | 20 | LPG 1 | 1496 |
| 911 Turbo 3.6 (993) | 3.6 | 265 | 94 - 94 | M64.50 | 6 | | BKR6EK | 2288 | 20 | LPG 1 | 1496 |
| 911 Turbo 3.6 Biturbo (993) | 3.6 | 300 | 98 - 98 | M64.60 | 6 | | BKR6EK | 2288 | 20 | LPG 1 | 1496 |
| 911 Turbo Look (964) | 3.6 | 184 | 92 - 92 | M64.01 | 6 | | BCPR7ET | 2164 | | BCPR7EIX | 5690 |
| 911 Turbo Look (964) | 3.6 | 184 | 92 - 92 | M64.02 | 6 | | BCPR7ET | 2164 | | BCPR7EIX | 5690 |
| 911 Turbo S (964) | 3.3 | 280 | 92 - 92 | M30.69SL | 6 | 0,8 | BPR8EIX | 6684 | | BPR9EIX | 6853 |
| 924 2.5 S | 2.5 | 120 | 07.81 - 12.84 | M 44.01/03 | 4 | 0,8 | BPR6ES | 7822 | 2 | LPG 2 | 1497 |
| 924 Carrera GT/GTS | 2.0 | 154 | 07.80 - 06.82 | M 31.50 | 4 | 0,6 | B8EGV | 5627 | | | |
| 924 S | 2.5 | 110 | 09.85 - 07.88 | M 44.07/08/09/10 | 4 | 0,8 | BPR6ES | 7822 | 2 | LPG 2 | 1497 |
| 924 Turbo | 2.0 | 130 | 07.80 - 06.83 | M 31.03 | 4 | 0,6 | B8EGV | 5627 | | | |
| 928 4.5 | 4.5 | 170 | -08.82 | M 28.13/14 | 8 | 0,8 | BPR5EIX | 6597 | | LPG 2 | 1497 |
| 928 GT | 5.0 | 243 | 01.89 - 07.91 | M 28.47 | 8 | 0,8 | BPR6ES | 7822 | 2 | LPG 2 | 1497 |
| 928 GTS | 5.4 | 250 | 08.91 - 11.95 | M 28.49/50 | 8 | 0,8 | BPR6ES | 7822 | 2 | LPG 2 | 1497 |
| 928 S | 4.7 | 200 | 12.84 - 07.86 | M 28.43/44 | 8 | 0,8 | BPR6ES | 7822 | 2 | LPG 2 | 1497 |
| 928 S | 4.7 | 212 | 12.84 - 07.86 | M 28.45/46 | 8 | 0,8 | BPR6ES | 7822 | 2 | LPG 2 | 1497 |
| 928 S4/CS | 5.0 | 235 | 08.86 - 07.91 | M 28.41/42 | 8 | 0,8 | BPR6ES | 7822 | 2 | LPG 2 | 1497 |
| 944 | 2.5 | 135 | 08.86 - 07.88 | M 44.40 | 4 | 0,8 | BPR6ES | 7822 | 2 | LPG 2 | 1497 |
| 944 | 2.7 | 121 | 11.88 - 08.89 | M 44.11/12 | 4 | 0,8 | BPR6ES | 7822 | 2 | LPG 2 | 1497 |
| 944 2.5 | 2.5 | 110 | 01.85 - 07.87 | M 44.02/04/07/08 | 4 | 0,8 | BPR6ES | 7822 | 2 | LPG 2 | 1497 |
| 944 2.5 | 2.5 | 118 | 01.85 - 07.88 | M 44.05/06/09/10 | 4 | 0,8 | BPR6ES | 7822 | 2 | LPG 2 | 1497 |
| 944 2.5 Turbo | 2.5 | 162 | 08.85 - 07.88 | M 44.50/51 | 4 | 0,8 | BPR6ES | 7822 | 2 | LPG 2 | 1497 |
| 944 2.5 Turbo | 2.5 | 184 | 09.87 - 07.91 | M 44.52 | 4 | 0,8 | BPR6ES | 7822 | 2 | LPG 2 | 1497 |
| 944 S2 | 3.0 | 155 | 12.88 - 07.91 | M 44.41 | 4 | 0,8 | BPR7ES | 2023 | 19 | BPR8EIX | 6684 |
| 944 Turbo | 2.5 | 162 | 08.85 - 07.88 | M 44.50/51 | 4 | 0,8 | BPR6ES | 7822 | 2 | LPG 2 | 1497 |
| 944 Turbo | 2.5 | 184 | 09.87 - 07.91 | M 44.52 | 4 | 0,8 | BPR6ES | 7822 | 2 | LPG 2 | 1497 |
| 959 | 2.8 | 330 | 05.86 - 07.88 | 959.50 | 6 | 0,7 | BR8EVX | 1262 | | BR9EIX | 3981 |
| 968 | 3.0 | 176 | 08.91 - 11.95 | M 44.43/44 | 4 | 0,8 | BPR6ES | 7822 | 2 | LPG 2 | 1497 |
| 968 Turbo S | 3.0 | 224 | 01.93 - 11.95 | | 4 | 0,8 | BKR6ES | 3783 | 28 | LPG 1 | 1496 |
| Boxster (986) | 2.5 | 150 | 09.96 - 08.99 | M 96.20 | 6 | | BKR6EK | 2288 | 20 | LPG 1 | 1496 |
| Boxster (986) | 2.7 | 168 | 09.99 - 07.02 | M 96.22 | 6 | | BKR6EQUIP | 3199 | 30 | LPG 1 | 1496 |



l kW



Cyl.

Order-
No. No.LPG/CNG
D-PowerOrder-
No.**PORSCHE**

| | | | | | | | | | | | |
|-----------------------|-----|-----|---------------|--------------|---|-----|-----------|------|----|------------|------|
| Boxster (1986) | 2.7 | 168 | 07.02 - | M 96.23 | 6 | | BKR6EQUIP | 3199 | 30 | LPG 1 | 1496 |
| Boxster (1987) | 2.7 | 176 | 12.04 - | M 96.25 | 6 | | BKR7EQUIP | 4285 | | | |
| Boxster (1987) | 2.7 | 180 | 07.06 - | M 97.20 | 6 | | BKR7EQUIP | 4285 | | | |
| Boxster (1987) | 2.9 | 188 | 08 - | M 96.25 / 20 | 6 | | BKR7EQUIP | 4285 | | | |
| Boxster S (1986) | 3.2 | 185 | 09.99 - 07.02 | M 96.21 | 6 | | BKR6EQUIP | 3199 | 30 | LPG 1 | 1496 |
| Boxster S (1986) | 3.2 | 191 | 07.02 - | M 96.24 | 6 | | BKR6EQUIP | 3199 | 30 | LPG 1 | 1496 |
| Boxster S (1987) | 3.2 | 206 | 09.04 - 08.06 | M 96.26 | 6 | | BKR7EQUIP | 4285 | | | |
| Boxster S (1987) | 3.4 | 217 | 09.06 - | M 97.21 | 6 | | BKR7EQUIP | 4285 | | | |
| Boxster S (1987) | 3.4 | 228 | 08 - | M 97.26 / 21 | 6 | | BKR7EQUIP | 4285 | | | |
| Boxster Spyder (1987) | 3.4 | 236 | 08 - | M 97.21 | 6 | | BKR7EQUIP | 4285 | | | |
| Cayenne (1955) | 2.5 | 128 | 04 - | BAC | 5 | █ | Y-741U | 6943 | | D-POWER 20 | 6943 |
| Cayenne (1955) | 3.2 | 184 | 10.03 - | M 02.2Y BFD | 6 | 0,9 | IZKR7B | 7563 | | IZKR7B | 7563 |
| Cayenne S (1955) | 4.5 | 250 | 10.02 - | M 48.00 | 8 | | BKR6EQUIP | 3199 | 30 | LPG 1 | 1496 |
| Cayenne Turbo (1955) | 4.5 | 331 | 10.02 - | M 48.50 | 8 | | PFR7Q | 7963 | | PFR7Q | 7963 |
| Cayman | 2.7 | 180 | 09.06 - | M 97.20 | 6 | | BKR7EQUIP | 4285 | | | |
| Cayman (1987C) | 2.9 | 195 | 08 - | M 97.20 | 6 | | BKR7EQUIP | 4285 | | | |
| Cayman S | 3.4 | 217 | 11.05 - | M 97.21 | 6 | | BKR7EQUIP | 4285 | | | |
| Cayman S (1987C) | 3.4 | 236 | 08 - | M 97.21 | 6 | | BKR7EQUIP | 4285 | | | |

PROTON

| | | | | | | | | | | | |
|---------|-----|-----|---------|--------------|---|-----|-----------|------|----|-------|------|
| 1300 | 1.3 | | - 10.92 | | 4 | 0,8 | BPR6ES | 7822 | 2 | LPG 2 | 1497 |
| 1300 | 1.3 | | 10.92 - | Multipoint | 4 | 0,9 | BPR5ES | 7422 | 6 | LPG 2 | 1497 |
| 1500 | 1.5 | | - 10.92 | | 4 | 0,8 | BPR6ES | 7822 | 2 | LPG 2 | 1497 |
| 1500 | 1.5 | | 10.92 - | Multipoint | 4 | 0,9 | BPR5ES | 7422 | 6 | LPG 2 | 1497 |
| 313 | 1.3 | 55 | 96 - | (Mitsubishi) | 4 | 1,1 | BPR5ES-11 | 4424 | | LPG 2 | 1497 |
| 315 | 1.5 | 64 | 96 - | (Mitsubishi) | 4 | 1,1 | BKR6E-11 | 2756 | 14 | LPG 1 | 1496 |
| 318 GTI | 1.9 | 100 | 09.99 - | | 4 | 1,1 | BKR6E-11 | 2756 | 14 | LPG 1 | 1496 |
| 413 | 1.3 | 55 | 05.96 - | C96 | 4 | 1,1 | BPR5ES-11 | 4424 | | LPG 2 | 1497 |
| 415 | 1.5 | 66 | 03.95 - | C97 | 4 | 1,1 | BPR5ES-11 | 4424 | | LPG 2 | 1497 |
| 416 | 1.6 | 85 | 03.95 - | C98 | 4 | 1,1 | BKR6E-11 | 2756 | 14 | LPG 1 | 1496 |
| 418 | 1.8 | 85 | 05.96 - | C99 | 4 | 1,1 | BKR6E-11 | 2756 | 14 | LPG 1 | 1496 |
| 418 LRS | 1.8 | 99 | 98 - | | 4 | 1,1 | BKR6E-11 | 2756 | 14 | LPG 1 | 1496 |
| Persona | 1.3 | | | 4G13 | 4 | 0,8 | BPR6ES | 7822 | 2 | LPG 2 | 1497 |
| Persona | 1.5 | | 11.93 - | 4G15 | 4 | 0,9 | BPR5ES | 7422 | 6 | LPG 2 | 1497 |
| Persona | 1.6 | | 11.93 - | 4G92 | 4 | 1,1 | BKR6E-11 | 2756 | 14 | LPG 1 | 1496 |
| Persona | 1.8 | | 09.96 - | 4G92 | 4 | 1,1 | BKR6E-11 | 2756 | 14 | LPG 1 | 1496 |
| Satria | 1.3 | | 03.00 - | | 4 | 0,9 | BPR5ES | 7422 | 6 | LPG 2 | 1497 |
| Wira | 1.5 | | 03.00 - | 4G15 | 4 | 1,1 | BPR5ES-11 | 4424 | | LPG 2 | 1497 |
| Wira | 1.6 | | 05.00 - | 4G92 | 4 | 1,1 | BKR6E-11 | 2756 | 14 | LPG 1 | 1496 |
| Wira | 1.8 | | 05.00 - | | 4 | 1,1 | BKR6E-11 | 2756 | 14 | LPG 1 | 1496 |

RELIANT

| | | | | | | | | | | | |
|-------|--|--|---------|--|---|-----|---------|------|----|-------|------|
| Robin | | | - 09.96 | | 4 | 0,9 | BPR5ES | 7422 | 6 | LPG 2 | 1497 |
| Robin | | | 09.96 - | | 4 | 0,8 | BCPR5ES | 6130 | 32 | LPG 3 | 1498 |

RENAULT

| | | | | | | | | | | | |
|---------------------------|-----|-----|---------------|-----------------|---|-----|---------|------|---|-------|------|
| Alpine A 610 | 3.0 | | | Z7X 744 | 6 | | BKUR7ET | 7873 | | PFR7Q | 7963 |
| Alpine V 6 | 2.9 | | 03.85 - 12.92 | | 6 | 0,8 | BP6EFS | 3812 | 5 | LPG 5 | 1516 |
| Alpine V 6 Turbo, Le Mans | 2.5 | | | Z7U 730/734 Z6W | 6 | 0,6 | BP7EFVX | 3344 | | | |
| Avantime | 2.2 | 110 | 06.02 - 03 | G9T 712 | 4 | █ | Y-517J | 3319 | | | |
| Avantime 2.0i 16V Turbo | 2.0 | 121 | 04.02 - | F4RT 760/762 | 4 | 0,9 | PFR6G-9 | 4377 | | | |
| Avantime 16V Turbo | 2.0 | 121 | 04.02 - | F4R 760/761 | 4 | 0,8 | BKR6EIX | 6418 | | LPG 1 | 1496 |



ℓ kW



Cyl.

Order-
No.VLINE
No.LPG/CNG
D-PowerOrder-
No.**RENAULT**

| | | | | | | | | | | | |
|-----------------------|-----|-----|--------------|-------------------------|---|-----|-----------|------|----|------------|------|
| Avantime 24V V6 | 3.0 | 154 | 02.02 - | L7X 720/721 | 6 | 1,1 | PLFR5A-11 | 6240 | | LPG 7 | 1640 |
| Cavalier D | | | | | 4 | █ | Y-924J | 7906 | | D-POWER 1 | 7906 |
| Cherokee D | 2.1 | 59 | | | 4 | █ | Y-908R | 4585 | | D-POWER 1 | 7906 |
| Clio | 1.1 | 35 | 06.90 -03.96 | C1E 700 | 4 | 0,8 | BP5ES | 6511 | 8 | LPG 2 | 1497 |
| Clio | 1.2 | 40 | 11.94 -03.96 | C3G 720 | 4 | 0,8 | BP5ESZ | 4691 | | LPG 2 | 1497 |
| Clio | 1.2 | 40 | 06.90 -02.98 | E5F 710/716 | 4 | 0,8 | BCP5ES | 7496 | 16 | LPG 3 | 1498 |
| Clio | 1.2 | 40 | 06.90 -02.98 | E5F 710/716 | 4 | 0,8 | BCP5ES | 7496 | 16 | LPG 3 | 1498 |
| Clio | 1.2 | 40 | 06.90 -02.98 | E7F 706/700 | 4 | 0,8 | BCP5ES | 7496 | 16 | LPG 3 | 1498 |
| Clio | 1.2 | 44 | 01.96 -06.97 | D7F 730 | 4 | 0,9 | BK5ESZ | 5675 | | | |
| Clio | 1.2 | 44 | 07.97 -02.98 | D7F 730 | 4 | | BKR5EK | 7956 | 23 | LPG 1 | 1496 |
| Clio | 1.4 | 55 | 06.90 -02.98 | E6J 712 / 713 | 4 | 0,8 | BCP5ES | 7496 | 16 | LPG 3 | 1498 |
| Clio | 1.4 | 55 | 06.90 - | E7J 718 / 719 | 4 | 0,8 | BCP5ES | 7496 | 16 | LPG 3 | 1498 |
| Clio | 1.4 | 55 | 04.96 - | E7J 754 | 4 | 0,8 | BCP5ES | 7496 | 16 | LPG 3 | 1498 |
| Clio | 1.4 | 58 | 06.90 -02.98 | E7J 710 / 711 | 4 | 0,8 | BCP5ES | 7496 | 16 | LPG 3 | 1498 |
| Clio | 1.7 | 66 | 06.90 -03.96 | F2N 770 | 4 | 0,8 | BP7ES | 2412 | | BPR7EIX | 4055 |
| Clio | 1.8 | 65 | 06.90 -04.96 | F3P 710/714 | 4 | 0,9 | BP6ESZ | 7639 | | LPG 2 | 1497 |
| Clio | 1.8 | 65 | 06.96 -02.98 | F3P 755 | 4 | 0,9 | BP6ESZ | 7639 | | LPG 2 | 1497 |
| Clio | 1.8 | 66 | 06.90 -02.98 | F3P | 4 | 0,7 | BP6ESZ | 7639 | | LPG 2 | 1497 |
| Clio | 1.8 | 79 | 08.95 - | F3P R758 | 4 | 0,7 | BP6ES | 7811 | 4 | LPG 2 | 1497 |
| Clio | 1.8 | 81 | 02.91 -04.96 | F3P 712 | 4 | 0,7 | BP6ESZ | 7639 | | LPG 2 | 1497 |
| Clio | 1.9 | 47 | 05.90 -02.91 | | 4 | █ | Y-908R | 4585 | | D-POWER 1 | 7906 |
| Clio | 1.9 | 48 | 03.91 -08.98 | F8Q 672/676/678/692/696 | 4 | █ | Y-927R | 5171 | | D-POWER 19 | 4916 |
| Clio | 1.9 | 48 | 05.90 -09.98 | F8Q 714/730/732 | 4 | █ | Y-913M | 3965 | | D-POWER 15 | 5317 |
| Clio 16V | 1.8 | 100 | 03.91 -03.96 | F7P 720/722 | 4 | | BKR6EKUB | 3584 | | LPG 1 | 1496 |
| Clio 2 | 1.2 | 44 | 03.98 - | D7F 720/722 | 4 | | BKR5EK | 7956 | 23 | LPG 1 | 1496 |
| Clio 2 | 1.2 | 44 | 10.99 - | D7F 726 | 4 | 0,9 | BKR6EZ | 4619 | 38 | LPG 1 | 1496 |
| Clio 2 | 1.2 | 44 | 10.99 - | D7F 726 | 4 | 0,9 | BKR6EZ | 4619 | 38 | LPG 1 | 1496 |
| Clio 2 | 1.4 | 55 | | E7J 634/635 | 4 | 0,9 | BKR6EZ | 4619 | 38 | LPG 1 | 1496 |
| Clio 2 | 1.4 | 55 | 03.98 -03.01 | E7J 780 | 4 | 0,9 | BKR5EZ | 7642 | 36 | LPG 1 | 1496 |
| Clio 2 | 1.4 | 55 | 07.00 - 03 | K7J 700/701 | 4 | 0,9 | BKR5EZ | 7642 | 36 | LPG 1 | 1496 |
| Clio 2 | 1.4 | 55 | 07.00 - 03 | K7J 710 | 4 | 0,9 | BKR5EZ | 7642 | 36 | LPG 1 | 1496 |
| Clio 2 | 1.6 | 66 | 03.98 -09.99 | K7M 745 | 4 | | BKR5EK | 7956 | 23 | LPG 1 | 1496 |
| Clio 2 | 1.6 | 81 | 02.99 - | K4M 748 | 4 | 0,9 | BKR6EZ | 4619 | 38 | LPG 1 | 1496 |
| Clio 2 | 1.9 | 48 | 03.98 -12.03 | F8Q 630/ 662 BBOEOF | 4 | █ | Y-506R | 4409 | | D-POWER 7 | 2419 |
| Clio 2 | 1.9 | 48 | 03.99 -12.03 | F8Q 632 | 4 | █ | Y-516J | 6416 | | D-POWER 12 | 6416 |
| Clio 2 16V | 1.2 | 55 | 03.00 - | D4F 712 / 714 | 4 | 0,8 | LZKAR7A | 6799 | | | |
| Clio 2 16V | 1.4 | 73 | 03.98 -06.00 | K4J 712/713 | 4 | 0,9 | BKR6EZ | 4619 | 38 | LPG 1 | 1496 |
| Clio 2 16V | 1.6 | 66 | 03.98 -09.99 | K7M 744 | 4 | | BKR5EK | 7956 | 23 | LPG 1 | 1496 |
| Clio 2 16V RS | 2.0 | 126 | 01.00 - | F4R 730 | 4 | 1,0 | PFR6E-10 | 3688 | | | |
| Clio 2 Dti | 1.9 | 59 | 01.99 -12.03 | F9Q 716 | 4 | █ | Y-740U | 4818 | | D-POWER 22 | 4818 |
| Clio 2 Dti | 1.9 | 59 | 03.99 -12.03 | F9Q 780 | 4 | █ | Y-732J | 5605 | | D-POWER 4 | 5605 |
| Clio 2 Dti | 1.9 | 59 | 01.99 -06.01 | F9Q 782 | 4 | █ | Y-740U | 4818 | | D-POWER 22 | 4818 |
| Clio 2 Phase 2 | 1.2 | 44 | 06.01 - | D7F GPL | 4 | | BKR5EVX | 2546 | | LPG 1 | 1496 |
| Clio 2 Phase 2 Dci | 1.5 | 48 | 06.01 - | K9K 704/710 | 4 | █ | Y-732J | 5605 | | D-POWER 4 | 5605 |
| Clio 2 Phase 2 Dci | 1.5 | 59 | 11.01 - | K9K 702 | 4 | █ | Y-732J | 5605 | | D-POWER 4 | 5605 |
| Clio 2 Phase 2 Dci | 1.5 | 74 | 04 - | K9K 712 | 4 | █ | Y-732J | 5605 | | D-POWER 4 | 5605 |
| Clio 2 Phase 2 16S | 1.2 | 55 | 01.02 - | D4F-712 | 4 | 0,8 | LZKAR7A | 6799 | | | |
| Clio 2 Phase 2 16S | 1.4 | 72 | 06.01 - | K4J 710/711 | 4 | 0,9 | BKR6EZ | 4619 | 38 | LPG 1 | 1496 |
| Clio 2 Phase 2 16S | 1.6 | 81 | 06.01 - | K4M 744/745 | 4 | 0,9 | BKR6EZ | 4619 | 38 | LPG 1 | 1496 |
| Clio 2 Phase 2 16V RS | 2.0 | 126 | 06.01 - | F4R 730 | 4 | 1,0 | PFR6E-10 | 3688 | | | |
| Clio 2 Phase 2 8S | 1.2 | 44 | 06.01 - | D7F 726 | 4 | 0,9 | BKR5EZ | 7642 | 36 | LPG 1 | 1496 |
| Clio 3 16V | 1.2 | 55 | 06.05 - | D4F 740/764 | 4 | 0,8 | LZKAR7A | 6799 | | | |



ℓ kW



Cyl.

Order-
No. No.LPG/CNG
D-PowerOrder-
No.**RENAULT**

| | | | | | | | | | | | |
|---------------------------|-----|-----|--------------|-------------------------|---|-----|-------------|-------|----|------------|-------|
| Clio 3 16V | 1.4 | 70 | 06.05 - | K4J 780 | 4 | 0,9 | BKR6EZ | 4619 | 38 | LPG 1 | 1496 |
| Clio 3 16V | 1.6 | 81 | 06.05 - | K4M 800/801/804 | 4 | 0,9 | BKR6EZ | 4619 | 38 | LPG 1 | 1496 |
| Clio 3 16V | 2.0 | 103 | 04.06 - | M4R (Nissan) | 4 | 1,1 | PLZKAR6A-11 | 5118 | | | |
| Clio 3 Dci | 1.5 | 51 | 06.05 - | K9K 768 | 4 | █ | Y-732J | 5605 | | D-POWER 4 | 5605 |
| Clio 3 Dci | 1.5 | 62 | 06.05 - | K9K 766 | 4 | █ | Y-732J | 5605 | | D-POWER 4 | 5605 |
| Clio 3 Dci | 1.5 | 77 | 06.05 - | K9K 764 | 4 | █ | Y-732J | 5605 | | D-POWER 4 | 5605 |
| Clio 3 TCE | 1.2 | 74 | 05.07 - | D4F 780 / 784 | 4 | 0,7 | ILKAR7A7 | 91432 | | ILKAR7A7 | 91432 |
| Clio RSi | 1.8 | 79 | 08.94 - | F3P 758 Cat. | 4 | 0,8 | BP7ES | 2412 | | BPR7EIX | 4055 |
| Clio Williams 2.0 16S | 2.0 | 110 | 12.93 -01.96 | F7R 700 | 4 | | BKR6EKUB | 3584 | | LPG 1 | 1496 |
| Espace 1 | 2.0 | 74 | 07.84 -03.91 | J6R | 4 | 0,8 | BP6EFS | 3812 | 5 | LPG 5 | 1516 |
| Espace 1 | 2.0 | 77 | 06.87 -03.91 | J7R | 4 | 0,7 | BP7EFS | 3526 | | | |
| Espace 1 | 2.1 | 65 | 10.84 -10.90 | J8S 240/774 | 4 | █ | Y-908R | 4585 | | D-POWER 1 | 7906 |
| Espace 2 | 2.0 | | 04.91 -10.96 | J7R 768 Cat | 4 | 0,8 | BP6EFS | 3812 | 5 | LPG 5 | 1516 |
| Espace 2 | 2.2 | 81 | 04.91 -10.96 | J7T 772 CAT | 4 | 0,7 | BP7EFS | 3526 | | | |
| Espace 2 | 2.2 | 85 | 91 -10.96 | G8T 714/716/760 | 4 | █ | Y-740U | 4818 | | D-POWER 22 | 4818 |
| Espace 2 | 2.8 | 113 | 04.91 -10.96 | Z7W 712/ 717 Cat | 6 | 0,7 | BP7EFS | 3526 | | | |
| Espace 3 | | | 09.00 - | F5R | 4 | 1,1 | LF4AP-11 | 5613 | | | |
| Espace 3 | 2.0 | 85 | 11.96 -09.00 | F3R 728 /729 /768 /769 | 4 | 0,9 | BPR5ES | 7422 | 6 | LPG 2 | 1497 |
| Espace 3 | 2.0 | 103 | 10.98 -10.02 | F4R 700 /701 | 4 | 0,9 | BKR6EZ | 4619 | 38 | LPG 1 | 1496 |
| Espace 3 Dci | 1.9 | 74 | 02.99 -12.02 | F9Q 722 | 4 | █ | Y-732J | 5605 | | D-POWER 4 | 5605 |
| Espace 3 Dci | 2.2 | 85 | 06.00 -12.02 | G9T 710 | 4 | █ | Y-517J | 3319 | | | |
| Espace 3 Dci | 2.2 | 96 | 06.00 -12.02 | | 4 | █ | Y-517J | 3319 | | | |
| Espace 3 DT | 2.2 | 81 | 10.96 -08.00 | G8T 714/716 | 4 | █ | Y-730U | 6704 | | D-POWER 17 | 6704 |
| Espace 3 Dti | 1.9 | 74 | 02.99 -12.02 | F9Q 716/730/734 | 4 | █ | Y-740U | 4818 | | D-POWER 22 | 4818 |
| Espace 3 V6 | 3.0 | 121 | 11.96 -09.98 | Z7X 775 | 6 | | BKR6EKUB | 3584 | | LPG 1 | 1496 |
| Espace 3 V6 24 V | 3.0 | 140 | 10.98 - | L7X 727 | 6 | 1,0 | PFR6E-10 | 3688 | | | |
| Espace 4 | 2.0 | 103 | 10.02 - | F4Rt | 4 | | BKR6EK | 2288 | 20 | LPG 1 | 1496 |
| Espace 4 | 3.5 | 180 | 10.02 - | V4Y 711 | 6 | 1,1 | PLFR5A-11 | 6240 | | LPG 7 | 1640 |
| Espace 4 Dci | 1.9 | 86 | 10.02 - | F9Q | 4 | █ | Y-732J | 5605 | | D-POWER 4 | 5605 |
| Espace 4 Dci | 2.2 | 110 | 03 - | G9T | 4 | █ | Y-517J | 3319 | | | |
| Espace 4 Turbo | 2.0 | 121 | 10.02 - | F4R 760 | 4 | 0,9 | PFR6G-9 | 4377 | | | |
| Express | 1.0 | | 03.86 -08.91 | C1C 706/700 | 4 | 0,8 | BP5ES | 6511 | 8 | LPG 2 | 1497 |
| Express | 1.0 | | 10.91 - | C1C | 4 | 0,8 | BP5ES | 6511 | 8 | LPG 2 | 1497 |
| Express | 1.1 | 35 | 06.87 -10.97 | C1E | 4 | 0,8 | BP5ES | 6511 | 8 | LPG 2 | 1497 |
| Express | 1.2 | 40 | 10.91 - | C3G 710 Cat. | 4 | 0,9 | BP5ESZ | 4691 | | LPG 2 | 1497 |
| Express | 1.2 | | 10.91 -10.97 | C1G | 4 | 0,8 | BP5ES | 6511 | 8 | LPG 2 | 1497 |
| Express | 1.4 | 44 | 03.86 -09.91 | C1J / C2J | 4 | 0,8 | BP5ES | 6511 | 8 | LPG 2 | 1497 |
| Express | 1.4 | 59 | 10.91 - | E7J Cat. | 4 | 0,8 | BCP5ES | 7496 | 16 | LPG 3 | 1498 |
| Express | 1.4 | | 08.92 - | C3J 760 Cat. | 4 | 0,9 | BPR5ES | 7422 | 6 | LPG 2 | 1497 |
| Express | 1.4 | | 10.91 - | E6J | 4 | 0,8 | BCP5ES | 7496 | 16 | LPG 3 | 1498 |
| Express | 1.6 | 40 | 07.86 -03.98 | F8M 720/730/736/760 | 4 | █ | Y-913M | 3965 | | D-POWER 15 | 5317 |
| Express | 1.9 | 48 | 09.94 -12.95 | F8Q 640/644/646/648 | 4 | █ | Y-927R | 5171 | | D-POWER 19 | 4916 |
| Express | 1.9 | 48 | 01.96 -03.98 | F8Q 640/680/682 | 4 | █ | Y-927R | 5171 | | D-POWER 19 | 4916 |
| Express | 1.9 | 48 | 09.91 -03.98 | F8Q 684/722/724/774/776 | 4 | █ | Y-913M | 3965 | | D-POWER 15 | 5317 |
| Fuego TL, GTL | 1.4 | 47 | 02.80 -10.85 | 847 ..., A2M . | 4 | 0,7 | BP6ES | 7811 | 4 | LPG 2 | 1497 |
| Fuego TS, GTS / Automatic | 1.6 | 71 | 10.80 -10.85 | 843 ..., A6M | 4 | 0,7 | BP6ES | 7811 | 4 | LPG 2 | 1497 |
| Fuego D, TD | 2.1 | 65 | 10.82 -07.84 | J8S | 4 | █ | Y-908R | 4585 | | D-POWER 1 | 7906 |
| Fuego GTX / TX | 2.0 | 81 | 10.80 -10.85 | 829.../J6R-.. | 4 | 0,8 | BP6EFS | 3812 | 5 | LPG 5 | 1516 |
| Fuego Turbo | 1.6 | 97 | 08.83 -10.85 | A5L-... | 4 | 0,6 | B8EG | 3430 | | | |
| Grand Espace Dci | 2.2 | 110 | 03 - | G9T | 4 | █ | Y-517J | 3319 | | | |
| Grand Espace Dci 16S | 2.2 | 85 | 06.00 -09.02 | G9T 710 | 4 | █ | Y-517J | 3319 | | | |
| Grand Espace Dci 16S | 2.2 | 96 | 06.00 -09.02 | | 4 | █ | Y-517J | 3319 | | | |



ℓ kW



Cyl.

Order-
No.V-LINE
No.LPG/CNG
D-PowerOrder-
No.**RENAULT**

| | | | | | | | | | | | |
|-------------------------|-----|-----|-------------|--|---|-----|-----------|------|----|------------|------|
| Grand Espace DT | 2.2 | 81 | 01.98-08.00 | G8T 714/716 | 4 | █ | Y-730U | 6704 | | D-POWER 17 | 6704 |
| Grand Espace Dti | 1.9 | 74 | 01.00- | F9Q 730/734 | 4 | █ | Y-740U | 4818 | | D-POWER 22 | 4818 |
| Grand Espace 3 Dci 16S | 2.2 | 95 | 06.00-09.02 | G9T 710 | 4 | █ | Y-517J | 3319 | | | |
| Grand Espace 4 | 2.0 | 121 | 03- | F4R | 4 | 0,9 | PFR6G-9 | 4377 | | | |
| Grand Espace 4 | 3.5 | 180 | 10.02- | V4Y 711 | 6 | 1,1 | PLFR5A-11 | 6240 | | LPG 7 | 1640 |
| Grand Espace 4 Dci | 1.9 | 86 | 10.02- | F9Q | 4 | █ | Y-732J | 5605 | | D-POWER 4 | 5605 |
| Grand Espace 4 Dci | 2.2 | 110 | 10.02- | | 4 | █ | Y-517J | 3319 | | | |
| Grand Espace Turbo | 2.0 | 121 | 03- | F4R 760/762 | 4 | 0,9 | PFR6G-9 | 4377 | | | |
| Grand Scenic 16 V | 1.6 | 85 | 03.04- | K4M | 4 | 0,9 | BKR6EZ | 4619 | 38 | LPG 1 | 1496 |
| Grand Scenic 16 V | 2.0 | 100 | 03.04- | F4R | 4 | 0,9 | BKR6EZ | 4619 | 38 | LPG 1 | 1496 |
| Grand Scenic Dci | 1.5 | 74 | 03.04- | K9K | 4 | █ | Y-732J | 5605 | | D-POWER 4 | 5605 |
| Grand Scenic Dci | 1.9 | 88 | 03.04- | F9Q | 4 | █ | Y-732J | 5605 | | D-POWER 4 | 5605 |
| Grand Scenic Turbo | 2.0 | 121 | 03.04- | F4RT 760 / 762 | 4 | 0,9 | PFR6G-9 | 4377 | | | |
| Kangoo | 1.2 | 44 | 05.00- | D7F 710/720/722/ 726 / 744 Euro2000 | 4 | 0,9 | BKR6EZ | 4619 | 38 | LPG 1 | 1496 |
| Kangoo | 1.2 | 44 | 05.00- | D7F 726 | 4 | 0,9 | BKR6EZ | 4619 | 38 | LPG 1 | 1496 |
| Kangoo | 1.2 | 44 | 05.00- | D7FGPL | 4 | | BKR5EVX | 2546 | | LPG 1 | 1496 |
| Kangoo | 1.4 | 55 | 07.00- | K7J 700/701 | 4 | 0,9 | BKR5EZ | 7642 | 36 | LPG 1 | 1496 |
| Kangoo | 1.6 | 70 | 07.01- | K7M 746 | 4 | | BKR5EK | 7956 | 23 | LPG 1 | 1496 |
| Kangoo 2 4X4 | 1.6 | 70 | 03- | K4M | 4 | 0,9 | BKR6EZ | 4619 | 38 | LPG 1 | 1496 |
| Kangoo Dci | 1.5 | 48 | 06.01- | K9K | 4 | █ | Y-732J | 5605 | | D-POWER 4 | 5605 |
| Kangoo Dci | 1.5 | 59 | 06.01- | K9K | 4 | █ | Y-732J | 5605 | | D-POWER 4 | 5605 |
| Kangoo Dci 4X4 | 1.9 | 59 | 11.01- | | 4 | █ | Y-732J | 5605 | | D-POWER 4 | 5605 |
| Kangoo Dti | 1.9 | 59 | 03.98- | F9Q 780 | 4 | █ | Y-732J | 5605 | | D-POWER 4 | 5605 |
| Kangoo (XCOA) | 1.2 | 44 | 10.97-04.00 | D7F 710 | 4 | | BKR5EK | 7956 | 23 | LPG 1 | 1496 |
| Kangoo (XCOC) | 1.4 | 55 | 10.97-03.99 | E7J 634/635/780 | 4 | 0,9 | BKR6EZ | 4619 | 38 | LPG 1 | 1496 |
| Kangoo 16V | 1.2 | 55 | 07.00- | D4F 712/714 | 4 | 0,8 | LZKAR7A | 6799 | | | |
| Kangoo 16V | 1.2 | 55 | 07- | D4F 722/740/772 | 4 | 0,9 | LZKAR7B | 5942 | | | |
| Kangoo 16V | 1.6 | 70 | 07.01- | K4M 708/750/752 | 4 | 0,9 | BKR6EZ | 4619 | 38 | LPG 1 | 1496 |
| Kangoo Express D | 1.9 | 40 | 03.98- | F8Q 662 | 4 | █ | Y-506R | 4409 | | D-POWER 7 | 2419 |
| Kangoo Express D | 1.9 | 48 | 03.98- | F8Q 630 | 4 | █ | Y-506R | 4409 | | D-POWER 7 | 2419 |
| Kangoo Express D | 1.9 | 48 | 03.99- | F8Q 632 | 4 | █ | Y-516J | 6416 | | D-POWER 12 | 6416 |
| Kangoo Express Dci | 1.5 | 48 | 07.03- | K9K | 4 | █ | Y-732J | 5605 | | D-POWER 4 | 5605 |
| Kangoo Express Dci | 1.5 | 59 | 04- | K9K | 4 | █ | Y-732J | 5605 | | D-POWER 4 | 5605 |
| Kangoo Express Dci | 1.9 | 62 | 04- | F9Q | 4 | █ | Y-732J | 5605 | | D-POWER 4 | 5605 |
| Koleos | 2.5 | 125 | 06.08- | QR25DE | 4 | 1,1 | LFR5A-11 | 6376 | | LPG 7 | 1640 |
| Koléos 2.5 | 2.5 | | 06.08- | QR25DE Nissan engine | 4 | 1,1 | LFR5A-11 | 6376 | | LPG 7 | 1640 |
| Laguna / Nevada | 1.8 | 66 | 01.94-12.00 | F3P 670/674/676/678 | 4 | 0,9 | BP6ESZ | 7639 | | LPG 2 | 1497 |
| Laguna / Nevada | 1.8 | 70 | 01.94-12.00 | F3P 720/724 | 4 | 0,9 | BP6ESZ | 7639 | | LPG 2 | 1497 |
| Laguna / Nevada | 1.9 | 103 | 03.94-12.00 | N7Q 700 | 4 | | BKR5EK | 7956 | 23 | LPG 1 | 1496 |
| Laguna / Nevada | 2.0 | 83 | 01.94-03.01 | F3R 722/723 | 4 | 0,9 | BP6ESZ | 7639 | | LPG 2 | 1497 |
| Laguna / Nevada | 3.0 | 123 | 04.94-05.96 | Z7X 760/765/767 | 6 | | BKR6EKUB | 3584 | | LPG 1 | 1496 |
| Laguna / Nevada | 3.0 | 143 | 06.96-04.98 | L7X 700/701 (980511→) | 6 | 1,0 | PFR6E-10 | 3688 | | | |
| Laguna / Nevada | 3.0 | | 09.96-04.98 | L7X 700/701 (→980511) | 6 | | BKR6EKC | 2848 | 26 | LPG 1 | 1496 |
| Laguna / Nevada Phase 2 | 1.6 | 81 | 04.98-12.00 | K4M 720/724 | 4 | | BKR5EK | 7956 | 23 | LPG 1 | 1496 |
| Laguna / Nevada Phase 2 | 1.8 | 88 | 09.98-12.00 | F4P 760 | 4 | 0,8 | BKR6ES | 3783 | 28 | LPG 1 | 1496 |
| Laguna / Nevada Phase 2 | 2.0 | 85 | 04.98-08.98 | F3R | 4 | 0,8 | BPR6ES | 7822 | 2 | LPG 2 | 1497 |
| Laguna / Nevada Phase 2 | 2.0 | 103 | 02.99-12.00 | F4R 780 | 4 | 0,8 | BKR6ES | 3783 | 28 | LPG 1 | 1496 |
| Laguna / Nevada Phase 2 | 3.0 | 143 | 05.98-12.00 | L7X 700/701 | 6 | 1,0 | PFR6E-10 | 3688 | | | |
| Laguna / Nevada D | 2.2 | 62 | 09.94- | G8T | 4 | █ | Y-730U | 6704 | | D-POWER 17 | 6704 |
| Laguna / Nevada DT | 2.2 | 85 | 03.96- | G8T Turbo | 4 | █ | Y-730U | 6704 | | D-POWER 17 | 6704 |
| Laguna / Nevada Phase 2 | 1.9 | 75 | 02.99-02.01 | F9Q 710 | 4 | █ | Y-732J | 5605 | | D-POWER 4 | 5605 |



ℓ kW



Cyl.

Order-
No. No.LPG/CNG
D-PowerOrder-
No.**RENAULT**

| | | | | | | | | | | | |
|-------------------------------|-----|-----|---------------|-----------------------------------|---|-----|-------------|------|----|-------------|------|
| Laguna / Nevada Phase 2 | 1.9 | 75 | 10.97 - 02.01 | F9Q 716 | 4 | █ | Y-740U | 4818 | | D-POWER 22 | 4818 |
| Laguna / Nevada Phase2 DT | 2.2 | 80 | 04.98 - | G8T Turbo | 4 | █ | Y-730U | 6704 | | D-POWER 17 | 6704 |
| Laguna / Nevada Phase2 Dti | 1.9 | 74 | 10.97 - | F9Q 716/730/734 | 4 | █ | Y-740U | 4818 | | D-POWER 22 | 4818 |
| Laguna 2 | 1.6 | 81 | 01.01 - | K4M 720 | 4 | 0,8 | BKR6ES | 3783 | 28 | LPG 1 | 1496 |
| Laguna 2 | 1.8 | 87 | 01.01 - | K4M 720 | 4 | 0,8 | BKR6ES | 3783 | 28 | LPG 1 | 1496 |
| Laguna 2 | 3.0 | 152 | 01.01 - | L7X 731 | 6 | 1,0 | PFR6E-10 | 3688 | | | |
| Laguna 2 / Estate | 1.6 | 81 | 01.01 - | K4M 720 | 4 | 0,9 | BKR6EZ | 4619 | 38 | LPG 1 | 1496 |
| Laguna 2 / Estate | 1.8 | 87 | 01.01 - | F4P 760 | 4 | 0,8 | BKR6ES | 3783 | 28 | LPG 1 | 1496 |
| Laguna 2 / Estate | 3.0 | 154 | 01.01 - | L7X | 6 | 1,0 | PFR6E-10 | 3688 | | | |
| Laguna 2 / Estate 16 V | 2.0 | 100 | 04 - | F4R atmo | 4 | 0,9 | BKR6EZ | 4619 | 38 | LPG 1 | 1496 |
| Laguna 2 / Estate 2.0 16V Die | 2.0 | | 09.01 - | F5R 700 | 4 | 1,1 | LFR4AP-11 | 5613 | | | |
| Laguna 2 / Estate Dci | 1.9 | 74 | 03.99 - | F9Q 710/717/718 | 4 | █ | Y-732J | 5605 | | D-POWER 4 | 5605 |
| Laguna 2 / Estate Dci | 1.9 | 81 | 03.01 - | | 4 | █ | Y-732J | 5605 | | D-POWER 4 | 5605 |
| Laguna 2 / Estate Dci | 1.9 | 88 | 01.01 - | F9QC 750 | 4 | █ | Y-732J | 5605 | | D-POWER 4 | 5605 |
| Laguna 2 / Estate Dci | 2.2 | 110 | 01.02 - | G9T 710 | 4 | █ | Y-517J | 3319 | | | |
| Laguna 2 / Estate Turbo | 2.0 | 121 | 03 - | F4RT 762 | 4 | 0,9 | PFR6G-9 | 4377 | | | |
| Laguna 3 | 1.5 | 80 | 10.07 - | | 4 | █ | Y-732J | 5605 | | D-POWER 4 | 5605 |
| Laguna 3 | 2.0 | 102 | 02.07 - | M4R Nissan | 4 | 1,1 | PLZKAR6A-11 | 5118 | | PLZKAR6A-11 | 5118 |
| Laguna 3 16V | 1.6 | 85 | 02.07 - | K4M | 4 | 0,9 | BKR6EZ | 4619 | 38 | LPG 1 | 1496 |
| Laguna 3 16V | 2.0 | 100 | 02.07 - | F4R | 4 | 0,9 | BKR6EZ | 4619 | 38 | LPG 1 | 1496 |
| Laguna 3 Turbo | 2.0 | 121 | 02.07 - | F4R 762 | 4 | 0,9 | PFR6G-9 | 4377 | | | |
| Laguna 3 Turbo | 2.0 | 151 | 02.07 - | F4R 830 | 4 | | PFR7Z-TG | 5768 | | | |
| Lagune 2 / Estate | 2.2 | 110 | 01.02 - | G9T 702 | 4 | █ | Y-517J | 3319 | | | |
| Logan (X90) | 1.4 | 55 | 05 - | K7J | 4 | 0,9 | BKR6E | 6962 | 28 | LPG 1 | 1496 |
| Logan (X90) | 1.6 | 66 | 05 - | K7M | 4 | 0,9 | BKR6E | 6962 | 28 | LPG 1 | 1496 |
| Master | 2.0 | 58 | | 829../J5R | 4 | 0,7 | BP6ES | 7811 | 4 | LPG 2 | 1497 |
| Master | 2.2 | | | J7T 782 | 4 | 0,8 | BP6EFS | 3812 | 5 | LPG 5 | 1516 |
| Master D | 2.1 | | 09.80 - 11.81 | 852 | 4 | █ | Y-208T | 1250 | | | |
| Master D T30 | 2.1 | 45 | 11.81 - 96 | 852 | 4 | █ | Y-908R | 4585 | | D-POWER 1 | 7906 |
| Master Dti | 2.8 | 85 | 09.97 - | S9W 700/702 | 4 | █ | Y-502R | 3852 | | | |
| Master D | 2.4 | | 09.80 - 05.82 | 8140 / S8U | 4 | █ | Y-208T | 1250 | | | |
| Master D | 2.5 | 59 | 07.98 - | S8U 770/772 | 4 | █ | Y-502R | 3852 | | | |
| Master D | 2.5 | 69 | 09.97 - | S8V 748 | 4 | █ | Y-910J | 3617 | | D-POWER 3 | 3617 |
| Master D | 2.5 | | 09.80 - 05.82 | 8140 / S8U | 4 | █ | Y-208T | 1250 | | | |
| Master D T 30 | 2.4 | 52 | 06.82 - 96 | 8140 / S8U | 4 | █ | Y-908R | 4585 | | D-POWER 1 | 7906 |
| Master D T28 | 2.5 | 57 | 01.81 - 12.85 | Sofim | 4 | █ | Y-914U | 2643 | | D-POWER 1 | 7906 |
| Master Dci | 1.9 | 59 | 06.00 - | F9Q 770 | 4 | █ | Y-732J | 5605 | | D-POWER 4 | 5605 |
| Master Dci | 2.2 | 85 | 00 - | G9T 710 | 4 | █ | Y-517J | 3319 | | | |
| Master Dci | 3.0 | 96 | 01.07 - | ZD30CDTi | 4 | █ | Y-522J | 5939 | | | |
| Master Dci 16S | 2.2 | 66 | 05.01 - | G9T 722 | 4 | █ | Y-517J | 3319 | | | |
| Master Dci 16S | 2.5 | 88 | 10.00 - | G9U 720/754 | 4 | █ | Y-517J | 3319 | | | |
| Master T28 , T33 , T35 | | | 07.98 - | | 4 | █ | Y-502R | 3852 | | | |
| Master Turbo D T35 | 2.5 | 55 | 06.82 - 96 | S9U | 4 | █ | Y-908R | 4585 | | D-POWER 1 | 7906 |
| Mégane | 1.8 | 88 | 10.00 - 09.03 | F4P-720 / 722 | 4 | 1,1 | BKR6E-11 | 2756 | 14 | LPG 1 | 1496 |
| Mégane IDE Coupé | 2.0 | 103 | 11.99 - | F5R 740 | 4 | 1,1 | LFR4AP-11 | 5412 | | | |
| Cab. Phase 2 2.0 16V Ide | | | | | | | | | | | |
| Mégane / Classic | 1.4 | 51 | 10.95 - 03.99 | E7J 624 | 4 | 0,8 | BCP5ES | 7496 | 16 | LPG 3 | 1498 |
| Mégane / Classic | 1.4 | 55 | 10.95 - 03.99 | E7J 764 | 4 | 0,8 | BCP5ES | 7496 | 16 | LPG 3 | 1498 |
| Mégane / Classic | 1.6 | 66 | 10.95 - 10.98 | K7M 702/703/720 | 4 | 0,8 | BCPR5ES | 6130 | 32 | LPG 3 | 1498 |
| Mégane / Classic | 1.6 | 66 | 10.98 - 04.99 | K7M 702/703/720 | 4 | 0,9 | BKR5EZ | 7642 | 36 | LPG 1 | 1496 |
| Mégane / Classic | 2.0 | 85 | 10.95 - 03.99 | F3R 750/751/791, 796, 797, 798 | 4 | 0,9 | BPR5ES | 7422 | 6 | LPG 2 | 1497 |



ℓ kW



Cyl.

Order-
No.VLINE
No.LPG/CNG
D-PowerOrder-
No.**RENAULT**

| | | | | | | | | | | | |
|-----------------------------|-----|-----|-------------|-----------------------------------|---|-----|----------|-------|----|------------|-------|
| Mégane / Classic | 2.0 | 110 | 10.95-03.99 | F7R 710/714 | 4 | | BKR6EKUB | 3584 | | LPG 1 | 1496 |
| Mégane / Classic D | 1.9 | 48 | 01.96- | F8Q 620/624 | 4 | █ | Y-927R | 5171 | | D-POWER 19 | 4916 |
| Mégane / Classic D | 1.9 | 48 | 03.99-02.01 | F8Q 622 | 4 | █ | Y-516J | 6416 | | D-POWER 12 | 6416 |
| Mégane / Classic D | 1.9 | 48 | 03.98- | F8Q 788 | 4 | █ | Y-506R | 4409 | | D-POWER 7 | 2419 |
| Mégane / Classic Dci | 1.9 | 77 | 03.99- | F9Q 731/732/736/740 | 4 | █ | Y-732J | 5605 | | D-POWER 4 | 5605 |
| Mégane / Classic Di | 1.9 | 66 | 01.96-08.99 | F9Q 730/734 | 4 | █ | Y-740U | 4818 | | D-POWER 22 | 4818 |
| Mégane / Classic DT | 1.9 | 66 | 01.96- | F8Q 784/786 | 4 | █ | Y-933J | 7947 | | D-POWER 25 | 7947 |
| Mégane / Classic Dti | 1.9 | 74 | 01.96- | F9Q 716/730/734 | 4 | █ | Y-740U | 4818 | | D-POWER 22 | 4818 |
| Mégane / Classic GPL | 1.6 | 66 | 07.97-04.99 | K7M 702 | 4 | 0,6 | BKR5EIX | 6341 | | BKR5EIX | 6341 |
| Mégane / Classic Phase 2 | 1.4 | 55 | 04.99- | E7J 626 | 4 | 0,8 | BKR6ES | 3783 | 28 | LPG 1 | 1496 |
| Mégane / Classic Phase 2 | 1.4 | 70 | 09.99- | K4J 750 | 4 | 0,9 | BKR6EZ | 4619 | 38 | LPG 1 | 1496 |
| Mégane / Classic Phase 2 | 1.6 | 66 | 04.99- | K7M 704 | 4 | | BKR5EK | 7956 | 23 | LPG 1 | 1496 |
| Mégane / Classic Phase 2 | 1.6 | 81 | 04.99- | K4M 700/701/704, 706 | 4 | 0,9 | BKR6EZ | 4619 | 38 | LPG 1 | 1496 |
| Mégane 2 | 1.4 | 70 | 03- | K4J 730 | 4 | 0,9 | BKR6EZ | 4619 | 38 | LPG 1 | 1496 |
| Mégane 2 | 1.6 | 85 | 03- | K4M 760 | 4 | 0,9 | BKR6EZ | 4619 | 38 | LPG 1 | 1496 |
| Mégane 2 | 2.0 | 100 | 03- | F4R | 4 | 0,9 | BKR6EZ | 4619 | 38 | LPG 1 | 1496 |
| Mégane 2 | 2.0 | 121 | 05- | F4R 762/776 | 4 | 0,9 | PFR6G-9 | 4377 | | | |
| Mégane 2 1.5 Dci | 1.5 | 59 | 09.02- | K9K 722 | 4 | █ | Y-732J | 5605 | | D-POWER 4 | 5605 |
| Mégane 2 1.5 Dci Berline | 1.5 | 59 | 09.03- | K9K 722 | 4 | █ | Y-732J | 5605 | | D-POWER 4 | 5605 |
| Mégane 2 1.5 Dci Break | 1.5 | 59 | 09.03- | K9K 722 | 4 | █ | Y-732J | 5605 | | D-POWER 4 | 5605 |
| Mégane 2 Coupé | 1.5 | 74 | 04- | K9K | 4 | █ | Y-732J | 5605 | | D-POWER 4 | 5605 |
| Mégane 2 Coupé / cab | 2.0 | 100 | 03- | F4R | 4 | 0,9 | BKR6EZ | 4619 | 38 | LPG 1 | 1496 |
| Mégane 2 Coupé / cab 16 V | 1.4 | 72 | 03- | K4J | 4 | 0,9 | BKR6EZ | 4619 | 38 | LPG 1 | 1496 |
| Mégane 2 Coupé / cab 16V | 1.6 | 85 | 03- | K4M | 4 | 0,9 | BKR6EZ | 4619 | 38 | LPG 1 | 1496 |
| Mégane 2 Coupe Dci | 1.9 | 88 | 09.02- | F9Q 800 | 4 | █ | Y-732J | 5605 | | D-POWER 4 | 5605 |
| Mégane 3 1.4 TCE 130 | 1.4 | 96 | 11.08- | H4J 700 | 4 | 0,7 | ILKAR7A7 | 91432 | | ILKAR7A7 | 91432 |
| Mégane Coupé / cab. phase 2 | 1.4 | 70 | 09.99- | K4J 750 | 4 | 0,9 | BKR6EZ | 4619 | 38 | LPG 1 | 1496 |
| Mégane Coupé / cab. phase 2 | 1.6 | 81 | 04.99- | K4M 700/701 | 4 | 0,9 | BKR6EZ | 4619 | 38 | LPG 1 | 1496 |
| Mégane Coupé / cab. phase 2 | 1.8 | 87 | 05.01- | F4P 760 | 4 | 0,8 | BKR6ES | 3783 | 28 | LPG 1 | 1496 |
| Mégane Coupé / cabrio | 1.6 | 66 | 10.95-10.98 | K7M 702/703 | 4 | 0,8 | BCPR5ES | 6130 | 32 | LPG 3 | 1498 |
| Mégane Coupé / cabrio | 1.6 | 66 | 10.98-03.99 | K7M 702/703 | 4 | 0,9 | BKR5EZ | 7642 | 36 | LPG 1 | 1496 |
| Mégane Coupé / cabrio | 2.0 | 85 | 10.95-03.99 | F3R 750/751/791, 796, 797, 798 | 4 | 0,9 | BPR5ES | 7422 | 6 | LPG 2 | 1497 |
| Mégane Coupé / cabrio | 2.0 | 110 | 10.95-03.99 | F7R 710/714 | 4 | | BKR6EKUB | 3584 | | LPG 1 | 1496 |
| Mégane Dti | 1.9 | 59 | 02.01- | F9Q 744 | 4 | █ | Y-732J | 5605 | | D-POWER 4 | 5605 |
| Mégane Phase 2 D | 1.9 | 48 | 09.99- | F8Q 620/624 | 4 | █ | Y-927R | 5171 | | D-POWER 19 | 4916 |
| Mégane Phase 2 D | 1.9 | 48 | 03.99- | F8Q 622/790 | 4 | █ | Y-516J | 6416 | | D-POWER 12 | 6416 |
| Mégane Phase 2 Dci | 1.9 | 77 | 03.99- | F9Q 718/722/731/736/780 | 4 | █ | Y-732J | 5605 | | D-POWER 4 | 5605 |
| Mégane Phase 2 Dti | 1.9 | 59 | 04.01- | F9QT 770 | 4 | █ | Y-732J | 5605 | | D-POWER 4 | 5605 |
| Mégane Phase 2 Dti | 1.9 | 74 | 01.96- | F9Q 716/730/734 | 4 | █ | Y-740U | 4818 | | D-POWER 22 | 4818 |
| Megane RS | | | | F4R 830 | 4 | | PFR7Z-TG | 5668 | | | |
| Megane RS | 2.0 | 147 | 06- | F4R 830 | 4 | | PFR7Z-TG | 5768 | | | |
| Megane RS | 2.0 | 165 | 03.04- | F4RT 774 | 4 | 0,9 | PFR7G-9 | 4371 | | | |
| Megane RS | 2.0 | 169 | 07- | F4RT 774 | 4 | | PFR7Z-TG | 5768 | | | |
| Mégane Scenic | 1.9 | 48 | 10.96-08.99 | F8Q 620/624 | 4 | █ | Y-927R | 5171 | | D-POWER 19 | 4916 |
| Mégane Scenic | 1.9 | 48 | 03.99- | F8Q 622/790 | 4 | █ | Y-516J | 6416 | | D-POWER 12 | 6416 |
| Mégane Scenic | 1.9 | 48 | 03.98- | F8Q 788 | 4 | █ | Y-506R | 4409 | | D-POWER 7 | 2419 |
| Mégane Scenic | 1.9 | 66 | 01.96- | F8Q 784/786 | 4 | █ | Y-933J | 7947 | | D-POWER 25 | 7947 |
| Mégane Scenic Di | 1.9 | 66 | 10.96-08.99 | F9Q 716/730/734 | 4 | █ | Y-740U | 4818 | | D-POWER 22 | 4818 |
| Mégane Scenic Dti | 1.9 | 74 | 01.96- | F9Q 716/730/734 | 4 | █ | Y-740U | 4818 | | D-POWER 22 | 4818 |
| Modus | 1.2 | 55 | 06.07- | D4F 722/740/772 | 4 | 0,9 | LZKAR7B | 5942 | | | |
| Modus | 1.2 | 74 | 05.07- | D4F 780 / 784 | 4 | 0,7 | ILKAR7A7 | 91432 | | ILKAR7A7 | 91432 |



ℓ kW

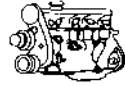

Cyl.

Order-
No. No.LPG/CNG
D-PowerOrder-
No.**RENAULT**

| | | | | | | | | | | | |
|-------------------|-----|----|---------------|---------------------|---|-----|----------|------|----|------------|------|
| Modus 16 V | 1.2 | 55 | 09.04 - 05.07 | D4F | 4 | 0,8 | LZKAR7A | 6799 | | | |
| Modus 16 V | 1.4 | 81 | 09.04 - | K4M | 4 | 0,9 | BKR6EZ | 4619 | 38 | LPG 1 | 1496 |
| Modus 16 V | 1.6 | 83 | 09.04 - | K4J | 4 | 0,9 | BKR6EZ | 4619 | 38 | LPG 1 | 1496 |
| Modus Dci | 1.5 | 48 | 09.04 - | K9K | 4 | █ | Y-732J | 5605 | | D-POWER 4 | 5605 |
| Modus Dci | 1.5 | 59 | 09.04 - | K9K | 4 | █ | Y-732J | 5605 | | D-POWER 4 | 5605 |
| R 11 | 1.1 | 35 | 03.83 - 06.86 | C1E 715 | 4 | 0,7 | BP6ES | 7811 | 4 | LPG 2 | 1497 |
| R 11 | 1.4 | 44 | 03.83 - 12.88 | C1J 715/C2J73 | 4 | 0,7 | BP6ES | 7811 | 4 | LPG 2 | 1497 |
| R 11 | 1.7 | | 10.83 - 03.91 | F2N-..., F3N-708 | 4 | 0,8 | BP7ES | 2412 | | BPR7EIX | 4055 |
| R 11 D | 1.6 | 40 | 01.83 - 03.91 | F8M 700/730 | 4 | █ | Y-913M | 3965 | | D-POWER 15 | 5317 |
| R 11 Turbo | 1.4 | 77 | 09.83 - 03.91 | C1J 760/764/770 | 4 | 0,6 | B8EVX | 7051 | | BR8EIX | 5044 |
| R 14 | 1.2 | | - 06.83 | | 4 | 0,8 | BP6EFS | 3812 | 5 | LPG 5 | 1516 |
| R 18 D | 2.1 | 48 | 08.80 - 02.86 | J8S | 4 | █ | Y-908R | 4585 | | D-POWER 1 | 7906 |
| R 18 D | 2.1 | 50 | 04.84 - 02.86 | J8S | 4 | █ | Y-908R | 4585 | | D-POWER 1 | 7906 |
| R 18 GTX | 2.0 | | - 02.86 | J6R-... | 4 | 0,8 | BP6EFS | 3812 | 5 | LPG 5 | 1516 |
| R 18 TD | 2.1 | 65 | 04.84 - 02.86 | J8S | 4 | █ | Y-908R | 4585 | | D-POWER 1 | 7906 |
| R 18 Turbo | 1.6 | 92 | 10.82 - 09.85 | A5L717/ 807-... | 4 | 0,7 | B8EG | 3430 | | | |
| R 19 | 1.2 | 40 | 09.88 - 30.92 | C1G 730 | 4 | 0,9 | BP5ESZ | 4691 | | LPG 2 | 1497 |
| R 19 | 1.4 | 43 | 09.88 - 03.92 | C1J 742, C2J 772 | 4 | 0,9 | BP5ESZ | 4691 | | LPG 2 | 1497 |
| R 19 | 1.4 | 50 | 09.88 - 03.96 | C2J 776 | 4 | 0,8 | BP5ES | 6511 | 8 | LPG 2 | 1497 |
| R 19 | 1.4 | 59 | 09.88 - 03.92 | E6J...,E7J... Cat. | 4 | 0,8 | BCP5ES | 7496 | 16 | LPG 3 | 1498 |
| R 19 | 1.7 | 54 | 03.86 - | F3N-740/741 | 4 | 0,8 | BPR6ES | 7822 | 2 | LPG 2 | 1497 |
| R 19 | 1.7 | 55 | 09.88 - 03.96 | F2N-724 | 4 | 0,8 | BP7ES | 2412 | | BPR7EIX | 4055 |
| R 19 | 1.7 | 66 | 09.88 - 03.92 | F3N 746 | 4 | 0,8 | BPR6ES | 7822 | 2 | LPG 2 | 1497 |
| R 19 | 1.7 | 66 | 09.88 - 03.92 | F3N-742/743 Cat | 4 | 0,8 | BP7ES | 2412 | | BPR7EIX | 4055 |
| R 19 | 1.7 | 68 | 09.88 - 03.96 | F2N 720/721 | 4 | 0,8 | BP7ES | 2412 | | BPR7EIX | 4055 |
| R 19 | 1.8 | 54 | 94 - | F3N 740 / 741 | 4 | 0,8 | BPR6ES | 7822 | 2 | LPG 2 | 1497 |
| R 19 | 1.8 | 81 | 06.89 - 03.92 | F7P 700 Cat. | 4 | | BKR6EKUB | 3584 | | LPG 1 | 1496 |
| R 19 16V | 1.8 | | 06.89 - 03.96 | F7P 704 Cat. | 4 | 0,7 | BCP6ES | 4930 | 17 | LPG 3 | 1498 |
| R 19 D | 1.9 | 48 | 06.88 - 02.91 | F8Q | 4 | █ | Y-908R | 4585 | | D-POWER 1 | 7906 |
| R 19 D | 1.9 | 48 | 03.91 - 12.95 | F8Q 706/742/764 | 4 | █ | Y-913M | 3965 | | D-POWER 15 | 5317 |
| R 19 Phase 2 | 1.2 | 40 | 04.92 - 12.95 | C1G 730 | 4 | 0,8 | BP5ESZ | 4691 | | LPG 2 | 1497 |
| R 19 Phase 2 | 1.2 | 45 | 04.92 - 12.95 | E7F 730 Cat | 4 | 0,8 | BCP5ES | 7496 | 16 | LPG 3 | 1498 |
| R 19 Phase 2 | 1.4 | 44 | 04.92 - 12.95 | C3J 710 Cat. | 4 | 0,9 | BPR5ES | 7422 | 6 | LPG 2 | 1497 |
| R 19 Phase 2 | 1.4 | 55 | 04.92 - 12.95 | E7J 706 | 4 | 0,8 | BCP5ES | 7496 | 16 | LPG 3 | 1498 |
| R 19 Phase 2 | 1.4 | 55 | 04.92 - 12.95 | E7J 745 | 4 | 0,8 | BCP5ES | 7496 | 16 | LPG 3 | 1498 |
| R 19 Phase 2 | 1.4 | | 04.92 - 12.95 | C1J | 4 | 0,8 | BP5ESZ | 4691 | | LPG 2 | 1497 |
| R 19 Phase 2 | 1.4 | | 04.92 - 12.95 | E6J...,E7J... Cat. | 4 | 0,8 | BCP5ES | 7496 | 16 | LPG 3 | 1498 |
| R 19 Phase 2 | 1.8 | 70 | 04.92 - 12.95 | F3P 704/706 Cat. | 4 | 0,7 | BP6ES | 7811 | 4 | LPG 2 | 1497 |
| R 19 Phase 2 | 1.8 | 99 | 04.92 - 12.95 | F7P 704 Cat. | 4 | | BKR6EKUB | 3584 | | LPG 1 | 1496 |
| R 19 Phase 2 | 1.8 | | 04.92 - 12.95 | F3P 705 | 4 | 0,7 | BP6ES | 7811 | 4 | LPG 2 | 1497 |
| R 19 Phase 2 | 1.8 | | 04.92 - 12.95 | F3P 707 | 4 | 0,7 | BP6ES | 7811 | 4 | LPG 2 | 1497 |
| R 19 Phase 2 | 1.8 | | 04.92 - 12.95 | F7P 700 Cat. | 4 | 0,9 | BP6ESZ | 7639 | | LPG 2 | 1497 |
| R 19 TD | 1.9 | 66 | 09.90 - 06.96 | F8Q 610/740/744/768 | 4 | █ | Y-933J | 7947 | | D-POWER 25 | 7947 |
| R 20 D | 2.1 | 47 | 05.81 - 12.83 | J8S736 | 4 | █ | Y-908R | 4585 | | D-POWER 1 | 7906 |
| R 20 LS / TS / TX | | | - 12.83 | 851/829/J6R | 4 | 0,8 | BP6EFS | 3812 | 5 | LPG 5 | 1516 |
| R 20 TD | 2.1 | 63 | 10.82 - 12.83 | J8S | 4 | █ | Y-908R | 4585 | | D-POWER 1 | 7906 |
| R 21 | 1.4 | 51 | 09.89 - 10.93 | C2J | 4 | 0,7 | BP6ES | 7811 | 4 | LPG 2 | 1497 |
| R 21 | 1.7 | | 09.89 - 12.95 | F3N 726 | 4 | 0,8 | BPR6ES | 7822 | 2 | LPG 2 | 1497 |
| R 21 | 2.0 | 66 | 08.86 - 12.95 | F2R 702 | 4 | 0,8 | BP7ES | 2412 | | BPR7EIX | 4055 |
| R 21 | 2.0 | 76 | 03.86 - 12.95 | J6R | 4 | 0,8 | BP6EFS | 3812 | 5 | LPG 5 | 1516 |
| R 21 | 2.0 | 99 | 06.90 - 12.93 | J7R 746/747 | 4 | 0,8 | BP6EFS | 3812 | 5 | LPG 5 | 1516 |
| R 21 Nevada | 2.2 | 79 | 01.93 - | J7T 754/755 | 4 | 0,9 | BP7EFS | 3526 | | | |



ℓ kW

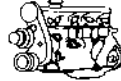

Cyl.

Order-
No.V-LINE
No.LPG/CNG
D-PowerOrder-
No.**RENAULT**

| | | | | | | | | | | | |
|-------------------|-----|-----|---------------|--------------------------------|---|-----|---------|------|----|------------|------|
| R 21 D / Nevada | 1.9 | 48 | 09.89 - 02.91 | F8Q | 4 | █ | Y-908R | 4585 | | D-POWER 1 | 7906 |
| R 21 D / Nevada | 1.9 | 48 | 03.91 - 95 | F8Q 710 | 4 | █ | Y-908R | 4585 | | D-POWER 1 | 7906 |
| R 21 D / Nevada | 2.1 | 53 | 09.89 - 12.93 | J8S | 4 | █ | Y-908R | 4585 | | D-POWER 1 | 7906 |
| R 21 Nevada | 1.7 | 65 | 03.86 - 12.95 | F2N 711 | 4 | 0,8 | BP7ES | 2412 | | BPR7EIX | 4055 |
| R 21 Nevada | 1.7 | 65 | 02.88 - 12.95 | F2N 754 | 4 | 0,8 | BP7ES | 2412 | | BPR7EIX | 4055 |
| R 21 Nevada | 1.7 | | 09.89 - 12.95 | F3N 722/723 | 4 | 0,8 | BP7ES | 2412 | | BPR7EIX | 4055 |
| R 21 Nevada | 2.0 | 85 | - 12.92 | J7R 750/751 | 4 | 0,8 | BP7EFS | 3526 | | | |
| R 21 Nevada | 2.0 | 98 | 05.89 - 12.95 | J7R 754 | 4 | | BCP6ET | 4563 | | LPG 3 | 1498 |
| R 21 Nevada | 2.0 | 110 | 09.89 - 12.95 | J7R 740 | 4 | | BCP6ET | 4563 | | LPG 3 | 1498 |
| R 21 Nevada Turbo | 2.0 | 119 | 08.89 - 10.93 | J7R 752 | 4 | 0,8 | BP7EFVX | 3344 | | | |
| R 21 Nevada Turbo | 2.0 | 119 | 01.93 - | J7R 756 | 4 | 0,8 | BP7EFVX | 3344 | | | |
| R 21 TD / Nevada | 2.1 | 65 | 03.86 - 12.93 | J8S | 4 | █ | Y-908R | 4585 | | D-POWER 1 | 7906 |
| R 25 | 2.0 | 74 | 01.84 - 12.92 | J6R 706/707 | 4 | 0,8 | BP6EFS | 3812 | 5 | LPG 5 | 1516 |
| R 25 | 2.0 | 74 | 01.84 - 12.92 | J6R 762/763 | 4 | 0,8 | BP6EFS | 3812 | 5 | LPG 5 | 1516 |
| R 25 | 2.0 | 88 | 06.87 - 12.92 | J7R 722/723 | 4 | 0,9 | BP7EFS | 3526 | | | |
| R 25 | 2.0 | 103 | 10.88 - 12.92 | J7R 720/721/726 | 4 | | BCP6ET | 4563 | | LPG 3 | 1498 |
| R 25 | 2.2 | 79 | 10.86 - 12.92 | J7T706/707/730/731/ 732/733 | 4 | 0,9 | BP7EFS | 3526 | | | |
| R 25 | 2.7 | 106 | 83 - 09.87 | Z7V | 6 | 1,0 | BPR6EFS | 3623 | 7 | LPG 5 | 1516 |
| R 25 D | 2.1 | 47 | 01.84 - 12.92 | J8S 736 | 4 | █ | Y-908R | 4585 | | D-POWER 1 | 7906 |
| R 25 TD | 2.1 | 63 | 01.84 - 12.92 | J8S 708/738 | 4 | █ | Y-908R | 4585 | | D-POWER 1 | 7906 |
| R 25 V6 | 2.8 | 110 | 06.87 - 12.92 | Z7W 700/701 | 6 | 0,9 | BP7EFS | 3526 | | | |
| R 25 V6 | 2.8 | 110 | 06.87 - 12.92 | Z7W 706/707 Cat. | 6 | 0,9 | BP7EFS | 3526 | | | |
| R 25 V6 Turbo | 2.5 | 147 | 05.89 - 12.92 | Z7U700 Cat. | 6 | 0,8 | BP7EFVX | 3344 | | | |
| R 30 TD | 2.1 | 85 | 09.81 - 12.83 | J8S | 4 | █ | Y-908R | 4585 | | D-POWER 1 | 7906 |
| R 4 alle Modelle | | | - 90 | | 4 | 0,6 | BP6HS | 4511 | 18 | BPR6HIX | 4085 |
| R 5 | 1.0 | 30 | 10.84 - 12.96 | C1C-700 | 4 | 0,7 | BP6ES | 7811 | 4 | LPG 2 | 1497 |
| R 5 | 1.2 | 40 | 10.86 - 12.96 | C1G 720/722 | 4 | 0,7 | BP6ES | 7811 | 4 | LPG 2 | 1497 |
| R 5 | 1.4 | 42 | 06.82 - 09.84 | 847-712 | 4 | 0,7 | BP6ES | 7811 | 4 | LPG 2 | 1497 |
| R 5 | 1.4 | 43 | 10.84 - 12.96 | C1J 768 | 4 | 0,7 | BP6ES | 7811 | 4 | LPG 2 | 1497 |
| R 5 | 1.4 | 44 | 06.87 - 12.96 | C2J 784 | 4 | 0,7 | BP6ES | 7811 | 4 | LPG 2 | 1497 |
| R 5 | 1.4 | 44 | 10.84 - 12.96 | C3J 700/702/760 | 4 | 0,9 | BPR5ES | 7422 | 6 | LPG 2 | 1497 |
| R 5 | 1.4 | 46 | 06.82 - 03.85 | C2J 713 | 4 | 0,7 | BP6ES | 7811 | 4 | LPG 2 | 1497 |
| R 5 | 1.4 | 49 | 10.84 - 12.96 | C2J 780/781/782 | 4 | 0,7 | BP6ES | 7811 | 4 | LPG 2 | 1497 |
| R 5 | 1.4 | 49 | 10.84 - 12.96 | C2J 788/789/798 | 4 | 0,7 | BP6ES | 7811 | 4 | LPG 2 | 1497 |
| R 5 | 1.4 | 50 | 06.87 - 12.96 | C2J 700 | 4 | 0,7 | BP6ES | 7811 | 4 | LPG 2 | 1497 |
| R 5 | 1.7 | 55 | 10.86 - 12.96 | F3N 716/717 | 4 | 0,8 | BPR6ES | 7822 | 2 | LPG 2 | 1497 |
| R 5 | 1.7 | 66 | 06.87 - 12.96 | F2N 740/742 | 4 | 0,7 | BP6ES | 7811 | 4 | LPG 2 | 1497 |
| R 5 | 1.7 | 69 | 10.86 - 12.96 | F3N 702 | 4 | 0,8 | BP7ES | 2412 | | BPR7EIX | 4055 |
| R 5 Alpine Turbo | | | 82 - 85 | 840726 / C6J728/750 | 4 | 0,6 | B8EFS | 1049 | | | |
| R 5 Rodéo | | | 82 - 86 | | 4 | 0,6 | BP6HS | 4511 | 18 | BPR6HIX | 4085 |
| R 5 Turbo | 1.4 | 77 | 10.84 - 12.96 | C1J 782/784 | 4 | 0,7 | B8EVX | 7051 | | BR8EIX | 5044 |
| R 5 Turbo | 1.4 | 81 | 10.81 - 12.85 | 840 726 | 4 | 0,6 | B8EFS | 1049 | | | |
| R 9 | 1.1 | 36 | 09.81 - 10.87 | C1E 715/720 | 4 | 0,7 | BP6ES | 7811 | 4 | LPG 2 | 1497 |
| R 9 | 1.2 | 40 | 09.85 - 03.91 | C1G 700/710 | 4 | 0,7 | BP6ES | 7811 | 4 | LPG 2 | 1497 |
| R 9 | 1.4 | 45 | 09.81 - | | 4 | 0,7 | BP6ES | 7811 | 4 | LPG 2 | 1497 |
| R 9 | 1.7 | | 09.84 - | F2N-../F3N-708 | 4 | 0,8 | BP7ES | 2412 | | BPR7EIX | 4055 |
| R 9 D | 1.6 | 40 | 01.83 - 12.92 | F8M 700/730 | 4 | █ | Y-913M | 3965 | | D-POWER 15 | 5317 |
| R 9 Turbo | 1.4 | 77 | 09.84 - 03.91 | C1J 760/764/770 | 4 | 0,7 | B8EVX | 7051 | | BR8EIX | 5044 |
| Rapid | 1.9 | | 03.86 - | | 4 | █ | Y-913M | 3965 | | D-POWER 15 | 5317 |
| Rapid Express | 1.9 | 34 | 09.94 - | F8Q 640 | 4 | █ | Y-927R | 5171 | | D-POWER 19 | 4916 |
| Rapid 1,4 | 1.4 | | 91 - | | 4 | 0,8 | BCP5ES | 7496 | 16 | LPG 3 | 1498 |



ℓ kW

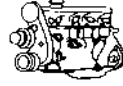

Cyl.

Order-
No. No.LPG/CNG
D-PowerOrder-
No.**RENAULT**

| | | | | | | | | | | | |
|------------------------|-----|-----|---------------|---------------------------------|---|-----|----------|-------|----|------------|-------|
| Safrane | 1.9 | | 06.92 - 09.96 | N7Q 710/ 711 | 4 | | BKR6EKUB | 3584 | | LPG 1 | 1496 |
| Safrane | 1.9 | | | N7Q 716 | 4 | | BKR6EKUB | 3584 | | LPG 1 | 1496 |
| Safrane | 2.0 | 77 | 06.92 - 09.96 | J7R 723/733 | 4 | 0,8 | BP6EFS | 3812 | 5 | LPG 5 | 1516 |
| Safrane | 2.0 | 97 | 04.92 - 09.96 | J7R 734/735/738/739 | 4 | | BCP6ET | 4563 | | LPG 3 | 1498 |
| Safrane | 2.2 | 103 | 06.92 - 09.96 | J7T 760/761 | 4 | | BCP6ET | 4563 | | LPG 3 | 1498 |
| Safrane | 2.2 | | 06.92 - 09.96 | J7T 762 | 4 | 0,8 | BP6EFS | 3812 | 5 | LPG 5 | 1516 |
| Safrane V6 | 3.0 | 123 | 10.96 - | Z7X W755 | 6 | | BKR6EK | 2288 | 20 | LPG 1 | 1496 |
| Safrane V6 | 3.0 | 125 | 06.92 - 09.96 | Z7X 721/722/723/753/755 | 6 | | BKR6EKUB | 3584 | | LPG 1 | 1496 |
| Safrane Biturbo | 3.0 | 194 | 94 - 09.96 | Z7X 726 | 6 | | BKUR7ET | 7873 | | PFR7Q | 7963 |
| Safrane DT | 2.1 | 65 | 06.92 - 09.96 | J8S 760 | 4 | ▣ | Y-908R | 4585 | | D-POWER 1 | 7906 |
| Safrane DT | 2.5 | 83 | 03.93 - 09.96 | S8U 762/763 | 4 | ▣ | Y-914U | 2643 | | D-POWER 1 | 7906 |
| Safrane Phase 2 | 1.9 | 100 | 10.96 - 12.00 | N7Q 710/711 | 4 | | BKR5EK | 7956 | 23 | LPG 1 | 1496 |
| Safrane Phase 2 | 2.5 | 121 | 10.96 - 12.00 | N7U 700/701 | 6 | 0,8 | BCPR6ES | 2330 | 12 | LPG 3 | 1498 |
| Safrane Phase 2 DT | 2.2 | 85 | 10.96 - 11.00 | G8T 740 | 4 | ▣ | Y-730U | 6704 | | D-POWER 17 | 6704 |
| Safrane Phase 2 V6 | 3.0 | 125 | 10.96 - 03.99 | Z7X 721/722/723/753/755 | 6 | | BKR6EKUB | 3584 | | LPG 1 | 1496 |
| Safrane Phase 2 V6 | 3.0 | 143 | 04.99 - 12.00 | L7X 713 | 6 | 1,0 | PFR6E-10 | 3688 | | | |
| Scenic | 1.4 | 55 | 10.95 - 03.99 | E7J 764 | 4 | 0,8 | BCP5ES | 7496 | 16 | LPG 3 | 1498 |
| Scenic | 1.6 | 66 | 10.95 - 09.98 | K7M 702,703,720 | 4 | 0,8 | BCPR5ES | 6130 | 32 | LPG 3 | 1498 |
| Scenic | 1.6 | 66 | 10.98 - 03.99 | K7M 702,703,720 | 4 | 0,9 | BKR5EZ | 7642 | 36 | LPG 1 | 1496 |
| Scenic | 2.0 | 85 | 10.95 - 03.99 | F3R 750/751/791, 796,797,798 | 4 | 0,9 | BPR5ES | 7422 | 6 | LPG 2 | 1497 |
| Scenic 2 & Break | 1.4 | 72 | 03 - | K4J | 4 | 0,9 | BKR6EZ | 4619 | 38 | LPG 1 | 1496 |
| Scenic 2 & Break | 1.6 | 85 | 03 - | K4M | 4 | 0,9 | BKR6EZ | 4619 | 38 | LPG 1 | 1496 |
| Scenic 2 & Break | 2.0 | 100 | 03 - | F4R | 4 | 0,9 | BKR6EZ | 4619 | 38 | LPG 1 | 1496 |
| Scénic 2 Dci | 1.5 | 59 | 03 - | K9K | 4 | ▣ | Y-732J | 5605 | | D-POWER 4 | 5605 |
| Scénic 2 Dci | 1.9 | 88 | 03 - | F9Q | 4 | ▣ | Y-732J | 5605 | | D-POWER 4 | 5605 |
| Scenic 2 DCI | 1.5 | 74 | 04 - | K9K | 4 | ▣ | Y-732J | 5605 | | D-POWER 4 | 5605 |
| Scenic D | 1.9 | 48 | 10.96 - 08.99 | F8Q 620/624 | 4 | ▣ | Y-927R | 5171 | | D-POWER 19 | 4916 |
| Scenic D | 1.9 | 48 | 03.99 - | F8Q 622/790 | 4 | ▣ | Y-516J | 6416 | | D-POWER 12 | 6416 |
| Scenic D | 1.9 | 48 | 03.98 - | F8Q 788 | 4 | ▣ | Y-506R | 4409 | | D-POWER 7 | 2419 |
| Scenic dci RX4 | 1.9 | 75 | 99 - | | 4 | ▣ | Y-732J | 5605 | | D-POWER 4 | 5605 |
| Scenic Di | 1.9 | 66 | 10.96 - 08.99 | F9Q 716/730/734 | 4 | ▣ | Y-740U | 4818 | | D-POWER 22 | 4818 |
| Scenic DT | 1.9 | 66 | 01.96 - | F8Q 784/786 | 4 | ▣ | Y-933J | 7947 | | D-POWER 25 | 7947 |
| Scenic Dti | 1.9 | 74 | 01.96 - | F9Q 716/730/734 | 4 | ▣ | Y-740U | 4818 | | D-POWER 22 | 4818 |
| Scenic GPL | 1.6 | 66 | 07.97 - 03.99 | K7M 702 | 4 | | BKR5EK | 7956 | 23 | LPG 1 | 1496 |
| Scenic III | 1.4 | 96 | 02.09 - | H4J 700 | 4 | 0,7 | ILKAR7A7 | 91432 | | ILKAR7A7 | 91432 |
| Scenic Phase 2 | 1.4 | 70 | 09.99 - | K4J 750 | 4 | 0,9 | BKR6EZ | 4619 | 38 | LPG 1 | 1496 |
| Scenic Phase 2 | 1.6 | 81 | 09.99 - | K4M 708/709 | 4 | 0,9 | BKR6EZ | 4619 | 38 | LPG 1 | 1496 |
| Scenic Phase 2 | 1.8 | 87 | 07.00 - | F4P 760 | 4 | 0,8 | BKR6ES | 3783 | 28 | LPG 1 | 1496 |
| Scenic Phase 2 | 2.0 | 103 | 08.99 - | F4R 740/741 | 4 | 0,8 | BKR6ES | 3783 | 28 | LPG 1 | 1496 |
| Scenic Phase 2 | 2.0 | 103 | 03.00 - | F4R 744 | 4 | 0,8 | BKR6ES | 3783 | 28 | LPG 1 | 1496 |
| Scenic Phase 2 D | 1.9 | 48 | 09.99 - | | 4 | ▣ | Y-927R | 5171 | | D-POWER 19 | 4916 |
| Scenic Phase 2 Dci | 1.9 | 77 | 03.99 - | F9Q 718/731/736/740 | 4 | ▣ | Y-732J | 5605 | | D-POWER 4 | 5605 |
| Scenic Phase 2 Dci RX4 | 1.9 | 77 | 09.00 - | F9Q 740 | 4 | ▣ | Y-732J | 5605 | | D-POWER 4 | 5605 |
| Scenic Phase 2 Dti | 1.9 | 59 | 06.01 - | F9Q T770 | 4 | ▣ | Y-732J | 5605 | | D-POWER 4 | 5605 |
| Scenic Phase 2 Dti | 1.9 | 74 | 09.99 - | F9Q 730/734/744 | 4 | ▣ | Y-740U | 4818 | | D-POWER 22 | 4818 |
| Spider | | | | F7R 710/712/720 | 4 | | BKR6EKUB | 3584 | | LPG 1 | 1496 |
| Sport Spider | 2.0 | 110 | 03.95 - | F7R 710/712/720 | 4 | | BKR6EKUB | 3584 | | LPG 1 | 1496 |
| Super 5 | 1.0 | | | C1C. | 4 | 0,8 | BP5ES | 6511 | 8 | LPG 2 | 1497 |
| Super 5 | 1.1 | | | C1E | 4 | 0,8 | BP5ES | 6511 | 8 | LPG 2 | 1497 |
| Super 5 | 1.2 | | | C1G | 4 | 0,8 | BP5ES | 6511 | 8 | LPG 2 | 1497 |
| Super 5 | 1.4 | 44 | 08.92 - | C3J 760 | 4 | 0,9 | BPR5ES | 7422 | 6 | LPG 2 | 1497 |



ℓ kW

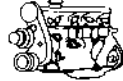

Cyl.

Order-
No.VLINE
No.LPG/CNG
D-PowerOrder-
No.**RENAULT**

| | | | | | | | | | | | |
|--------------------------------------|-----|-----|---------------|--------------------------------------|---|-----|-----------|-------|----|------------|-------|
| Super 5 | 1.4 | | | C2J | 4 | 0,8 | BP5ES | 6511 | 8 | LPG 2 | 1497 |
| Super 5 | 1.6 | 40 | 09.85 - 12.90 | F8M 720/730 | 4 | █ | Y-913M | 3965 | | D-POWER 15 | 5317 |
| Super 5 | 1.7 | | | F2N... | 4 | 0,8 | BP7ES | 2412 | | BPR7EIX | 4055 |
| Super 5 D | 1.6 | 40 | 09.85 - 12.96 | F8M 720/730 | 4 | █ | Y-913M | 3965 | | D-POWER 15 | 5317 |
| Super 5 GT Turbo | 1.4 | | | C1J 782/784/788 | 4 | 0,7 | B8EVX | 7051 | | BR8EIX | 5044 |
| Super 5 D | 1.6 | 40 | 09.85 - | | 4 | █ | Y-913M | 3965 | | D-POWER 15 | 5317 |
| Trafic D | 2.5 | 52 | 10.82 - 10.97 | S8U | 4 | █ | Y-208T | 1250 | | | |
| Trafic D | 2.5 | 55 | 03.90 - 10.97 | Sofim 8140 | 4 | █ | Y-908R | 4585 | | D-POWER 1 | 7906 |
| Trafic D P1000, P1200, 4x4 | 2.1 | 43 | 11.81 - 10.97 | 852/720/750 | 4 | █ | Y-908R | 4585 | | D-POWER 1 | 7906 |
| Trafic D T 1000 | 2.1 | 56 | 11.97 - | S8U 758/780/782 | 4 | █ | Y-910J | 3617 | | D-POWER 3 | 3617 |
| Trafic D T800, T1000, T1200 | 2.1 | 43 | 09.80 - 10.97 | J8S 620/758 | 4 | █ | Y-908R | 4585 | | D-POWER 1 | 7906 |
| Trafic Dci | 1.9 | 60 | 05.01 - | F9Q 762 | 4 | █ | Y-732J | 5605 | | D-POWER 4 | 5605 |
| Trafic Dci | 1.9 | 74 | 05.01 - | F9Q 760 | 4 | █ | Y-732J | 5605 | | D-POWER 4 | 5605 |
| Trafic D T 1000 | 1.9 | 45 | 11.97 - | F8Q 600/606 | 4 | █ | Y-506R | 4409 | | D-POWER 7 | 2419 |
| Trafic P1200 / T1200 | 1.6 | | | A1M-.../ 841 | 4 | 0,7 | BP6ES | 7811 | 4 | LPG 2 | 1497 |
| Trafic T1100 / P1000 | 1.7 | 50 | 06.86 - 04.89 | F1N-... | 4 | 0,8 | BP7ES | 2412 | | BPR7EIX | 4055 |
| Trafic T1100 / P1400 / T1400 / V1000 | 2.0 | 59 | 09.89 - 12.97 | J5R- 829 | 4 | 0,7 | BP6ES | 7811 | 4 | LPG 2 | 1497 |
| Trafic T1400 | 2.2 | | | J7T 780 | 4 | 0,8 | BP6EFS | 3812 | 5 | LPG 5 | 1516 |
| Trafic T800 / P800 | 1.4 | 35 | 03.80 - 04.89 | C1J-.../847-... | 4 | 0,7 | BP6ES | 7811 | 4 | LPG 2 | 1497 |
| Trafic V1000 / T1000 / 4X4 | 1.6 | | | A1M-.../ 841 | 4 | 0,7 | BP6ES | 7811 | 4 | LPG 2 | 1497 |
| Twingo | 1.2 | 40 | 03.93 - 06.97 | C3G 700 | 4 | 0,9 | BP5ESZ | 4691 | | BPR5EIX | 6597 |
| Twingo | 1.2 | 44 | 07.97 - 07.98 | D7F 700/701/702 / 703 / 704 / 706 | 4 | | BKR5EK | 7956 | 23 | LPG 1 | 1496 |
| Twingo | 1.2 | 44 | 04.94 - 06.97 | D7F 730 | 4 | 0,8 | BK5ESZ | 5675 | | | |
| Twingo | 1.2 | 44 | 04.00 - | D7F GPL | 4 | | BKR5EVX | 2546 | | BKR5EIX | 6341 |
| Twingo 2 | 1.2 | 44 | 06.07 - | D4F 764 | 4 | 0,9 | LZKAR7B | 5942 | | | |
| Twingo 2 | 1.2 | 44 | 08.98 - | D7F 702/703 | 4 | | BKR5EK | 7956 | 23 | LPG 1 | 1496 |
| Twingo 2 | 1.2 | 44 | 08 - | D7F 800 | 4 | 0,9 | BKR6EZ | 4619 | 38 | LPG 1 | 1496 |
| Twingo 2 | 1.2 | 55 | 06.07 - | D4F 722/740/772 | 4 | 0,9 | LZKAR7B | 5942 | | | |
| Twingo 2 | 1.2 | 74 | 06.07 - | D4F 780 | 4 | 0,7 | ILKAR7A7 | 91432 | | ILKAR7A7 | 91432 |
| Twingo 2 Euro2000 | 1.2 | 44 | 04.00 - | D7F 726 | 4 | 0,9 | BKR6EZ | 4619 | 38 | LPG 1 | 1496 |
| Twingo 2 16V | 1.2 | 55 | 11.00 - | D4F 702/703/704/740 | 4 | 0,8 | LZKAR7A | 6799 | | | |
| Twingo 2 DCI | 1.5 | 48 | 06.07 - | K9K | 4 | █ | Y-732J | 5605 | | D-POWER 4 | 5605 |
| Twingo easy | 1.2 | 40 | 09.94 - 96 | C3G 702 | 4 | 0,9 | BP5ESZ | 4691 | | LPG 2 | 1497 |
| Vel Satis | 2.0 | 147 | 06 - | F4R 830 | 4 | | PFR7Z-TG | 5768 | | | |
| Vel Satis 16V Turbo | 2.0 | 121 | 03.02 - | F4R 760/762 | 4 | 0,9 | PFR6G-9 | 4377 | | | |
| Vel Satis 24V V6 | 3.5 | 180 | 02.02 - | V4Y 701 | 6 | 1,1 | PLFR5A-11 | 6240 | | LPG 7 | 1640 |
| Vel Satis Dci | 2.2 | 85 | 03.02 - | | 4 | █ | Y-517J | 3319 | | | |
| Vel Satis Dci | 2.2 | 85 | 03.02 - 12.03 | G9T | 4 | █ | Y-517J | 3319 | | | |
| Vel Satis Dci | 2.2 | 110 | 03.02 - 12.03 | G9T 702 | 4 | █ | Y-517J | 3319 | | | |
| Winnebago | 2.1 | 43 | 04.82 - 06.87 | J8S 232/234 | 4 | █ | Y-908R | 4585 | | D-POWER 1 | 7906 |

ROLLS ROYCE

| | | | | | | | | | | | |
|-----------------|------|-----|---------------|------------|----|-----|----------|------|----|---------|------|
| Corniche 71—>02 | 6.75 | | 01.89 - 06.93 | | 8 | 0,9 | BPR4EVX | 3436 | | | |
| Corniche 71—>02 | 6.75 | | 03.87 - 12.88 | | 8 | 0,7 | BPR5EV | 4728 | | BPR5EIX | 6597 |
| Corniche 71—>02 | 6.75 | | 07.93 - 08.95 | | 8 | 0,9 | BKR4EVX | 4870 | | | |
| Corniche 71—>02 | 6.75 | | 09.95 - | | 8 | | BKR5EVX | 2546 | | BKR5EIX | 6341 |
| Flying Spur | 6.75 | | 08.94 - 07.95 | | 8 | | BKR5EVX | 2546 | | BKR5EIX | 6341 |
| Park Ward | 5.4 | | 10.00 - | V12 BMW | 12 | | BKR6EQUP | 3199 | 30 | LPG 1 | 1496 |
| Park Ward | 6.8 | | 02.97 - 09.00 | | 8 | 0,9 | BKR4EVX | 4870 | | | |
| Silver Dawn | 6.75 | | 94 - 98 | | 8 | | BKR5EVX | 2546 | | BKR5EIX | 6341 |
| Silver Seraph | 5.4 | 240 | 98 - 07.99 | BMW M73B54 | 12 | | BKR6EK | 2288 | 20 | LPG 1 | 1496 |



l kW



Cyl.

Order-
No. No.LPG/CNG
D-PowerOrder-
No.**ROLLS ROYCE**

| | | | | | | | | | | | |
|---------------------|------|-----|---------------|------------|----|-----|---------|------|----|---------|------|
| Silver Seraph | 5.4 | 240 | 08.99 - | BMW M73B54 | 12 | | BKR6EQU | 3199 | 30 | LPG 1 | 1496 |
| Silver Spirit/ Spur | 6.75 | | 01.89 - 06.93 | | 8 | 0,9 | BPR4EVX | 3436 | | | |
| Silver Spirit/ Spur | 6.75 | | 07.93 - | | 8 | 0,9 | BKR4EVX | 4870 | | | |
| Silver Spirit/ Spur | 6.75 | | 10.80 - 11.86 | | 8 | 0,9 | BPR5ES | 7422 | 6 | LPG 2 | 1497 |
| Silver Spirit/ Spur | 6.75 | | 12.86 - 12.88 | | 8 | 0,7 | BPR5EV | 4728 | | BPR5EIX | 6597 |

ROVER

| | | | | | | | | | | | |
|--------------------|-----|-----|---------------|-----------------------------|---|-----|-----------|------|----|------------|------|
| 111 | 1.1 | 44 | 91 - | K8 8 VALVE | 4 | 0,9 | BKR6E | 6962 | 28 | LPG 1 | 1496 |
| 114 | 1.4 | 55 | 91 - | K8 | 4 | 0,9 | BKR6E | 6962 | 28 | LPG 1 | 1496 |
| 114 | 1.4 | | 91 - | K16 | 4 | 0,9 | BKR6E | 6962 | 28 | LPG 1 | 1496 |
| 114 D | 1.4 | 39 | | Peugeot TUD 3 | 4 | █ | Y-910J | 3617 | | D-POWER 3 | 3617 |
| 115 SD/CSD | 1.5 | 57 | 01.95 - 98 | TUD 5 | 4 | █ | Y-503J | 1009 | | D-POWER 10 | 1009 |
| 2000 SD1 | 2.0 | | 01.82 - 10.86 | | 4 | 0,8 | BP6EFS | 3812 | 5 | LPG 5 | 1516 |
| 211 | 1.1 | 43 | 01.98 - 04.99 | K Series 8 V | 4 | 0,8 | BKR6ES | 3783 | 28 | LPG 1 | 1496 |
| 213 Mk.1 | 1.3 | | 06.84 - 09.90 | Honda | 4 | 1,1 | BPR6EY-11 | 4228 | 10 | LPG 2 | 1497 |
| 214 Mk.2 | 1.4 | | 10.89 - | K Series | 4 | 0,9 | BKR6E | 6962 | 28 | LPG 1 | 1496 |
| 214 Mk.3 | 1.4 | | 11.95 - | | 4 | 0,9 | BKR6E | 6962 | 28 | LPG 1 | 1496 |
| 216 Mk.1 | 1.6 | | 03.85 - 09.90 | Injection | 4 | 0,8 | BCPR6ES | 2330 | 12 | LPG 3 | 1498 |
| 216 Mk.1 | 1.6 | | 03.85 - 09.90 | Vergaser/Carb. | 4 | 0,7 | BCP6ES | 4930 | 17 | LPG 3 | 1498 |
| 216 Mk.2 | 1.6 | | 09.90 - | DOHC | 4 | 1,1 | BCPR6E-11 | 3132 | 11 | LPG 3 | 1498 |
| 216 Mk.2 | 1.6 | | 10.89 - | SOHC | 4 | 1,1 | BCPR6E-11 | 3132 | 11 | LPG 3 | 1498 |
| 216 Mk.3 | 1.6 | | 11.95 - | | 4 | 0,9 | BKR6E | 6962 | 28 | LPG 1 | 1496 |
| 217 SD, 218 SD/SLD | 1.9 | 49 | 09.91 - | XUD 9 | 4 | █ | Y-924J | 7906 | | D-POWER 1 | 7906 |
| 218 D | 1.9 | 49 | 09.91 - | XUD 9 | 4 | █ | Y-924J | 7906 | | D-POWER 1 | 7906 |
| 218 Mk.3 | 1.8 | 107 | 01.96 - | K Series with VVC | 4 | 1,1 | PFR6N-11 | 3546 | | LPG 1 | 1496 |
| 218 TD | 1.8 | 65 | 09.91 - | XUD 7 TE | 4 | █ | Y-924J | 7906 | | D-POWER 1 | 7906 |
| 220 Mk.2 | 2.0 | | 06.91 - | T16 TURBO | 4 | 0,9 | BKR6E | 6962 | 28 | LPG 1 | 1496 |
| 220 SDi | 2.0 | 63 | 10.95 - | 20 T2R | 4 | █ | Y-730U | 6704 | | D-POWER 17 | 6704 |
| 220 SDi | 2.0 | 77 | 10.95 - | 20T2N (Intercooled) | 4 | █ | Y-730U | 6704 | | D-POWER 17 | 6704 |
| 2400 TD | | | 82 - | | 4 | █ | Y-924J | 7906 | | D-POWER 1 | 7906 |
| 2400 TD SDI | 2.4 | | 82 - 86 | | 4 | █ | Y-909R | 4602 | | | |
| 25 | 1.1 | 43 | 11.99 - | K Series | 4 | 1,0 | PFR6N-11 | 3546 | | LPG 1 | 1496 |
| 25 | 1.4 | 62 | 11.99 - | K Series | 4 | 1,1 | PFR6N-11 | 3546 | | LPG 1 | 1496 |
| 25 | 1.6 | 79 | 11.99 - | K Series | 4 | 1,0 | PFR6N-11 | 3546 | | LPG 1 | 1496 |
| 25 | 1.8 | 85 | 99 - | K Series with VVC | 4 | 1,1 | PFR6N-11 | 3546 | | LPG 1 | 1496 |
| 25 | 1.8 | 107 | 02.00 - | K Series | 4 | 1,1 | PFR6N-11 | 3546 | | LPG 1 | 1496 |
| 25 Steptronic | 1.8 | 86 | 05.01 - | | 4 | 1,1 | PFR6N-11 | 3546 | | LPG 1 | 1496 |
| 25 TD | 2.0 | 74 | 11.99 - | | 4 | █ | Y-730U | 6704 | | D-POWER 17 | 6704 |
| 400 D | | | 01.87 - | | 4 | █ | Y-924J | 7906 | | D-POWER 1 | 7906 |
| 414 Mk.1 | 1.4 | | 03.90 - 07.95 | | 4 | 0,9 | BKR6E | 6962 | 28 | LPG 1 | 1496 |
| 414 Mk.2 | 1.4 | | 05.95 - | | 4 | 0,9 | BKR6E | 6962 | 28 | LPG 1 | 1496 |
| 416 Mk.1 | 1.6 | | 03.90 - 12.91 | DOHC | 4 | 1,1 | BCPR6E-11 | 3132 | 11 | LPG 3 | 1498 |
| 416 Mk.1 | 1.6 | | 03.90 - | SOHC | 4 | 1,1 | BCPR6E-11 | 3132 | 11 | LPG 3 | 1498 |
| 416 Mk.2 | 1.6 | | 05.95 - | Automatik | 4 | 1,1 | BKR6E-11 | 2756 | 14 | LPG 1 | 1496 |
| 416 Mk.2 | 1.6 | | 05.95 - | Schaltgetriebe | 4 | 0,9 | BKR6E | 6962 | 28 | LPG 1 | 1496 |
| 418 | 1.8 | 105 | 03.96 - 10.97 | K Series | 4 | 1,0 | PFR6N-11 | 3546 | | LPG 1 | 1496 |
| 418 SLD/GSD TD | 1.8 | 65 | 09.91 - 03.96 | XUD 7 T | 4 | █ | Y-924J | 7906 | | D-POWER 1 | 7906 |
| 420 D / SD | 2.0 | 63 | 07.95 - | | 4 | █ | Y-730U | 6704 | | D-POWER 17 | 6704 |
| 420 Di / Sdi | 2.0 | 77 | 07.95 - | | 4 | █ | Y-730U | 6704 | | D-POWER 17 | 6704 |
| 420 Mk.1 | 2.0 | | 10.91 - 11.94 | | 4 | 0,9 | BKR6E | 6962 | 28 | LPG 1 | 1496 |
| 420 Mk.2 | 2.0 | | 12.95 - | | 4 | 0,7 | BCP6ES | 4930 | 17 | LPG 3 | 1498 |
| 420 SDi, SLDi TD | 2.0 | | 10.95 - 99 | 20 T2R, 20T2N (Intercooled) | 4 | █ | Y-730U | 6704 | | D-POWER 17 | 6704 |



ℓ kW

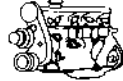

Cyl.

Order-
No.VLINE
No.LPG/CNG
D-PowerOrder-
No.**ROVER**

| | | | | | | | | | | | |
|-----------------------|-----|-----|---------------|-----------------------------|---|-----|-----------|------|----|------------|------|
| 420 Turbo | 2.0 | | 92 - | T16 TURBO | 4 | 0,9 | BKR6E | 6962 | 28 | LPG 1 | 1496 |
| 45 | 1.4 | 76 | 11.99 - | K Series | 4 | 1,1 | PFR6N-11 | 3546 | | LPG 1 | 1496 |
| 45 | 1.6 | 80 | 11.99 - | K Series | 4 | 1,1 | PFR6N-11 | 3546 | | LPG 1 | 1496 |
| 45 | 1.8 | 86 | 99 - | K Series | 4 | 1,1 | PFR6N-11 | 3546 | | LPG 1 | 1496 |
| 45 | 2.0 | 110 | 99 - | KV6 | 6 | 1,1 | PFR6N-11 | 3546 | | LPG 1 | 1496 |
| 45 TD | 2.0 | 73 | 11.99 - | | 4 | █ | Y-730U | 6704 | | D-POWER 17 | 6704 |
| 618 | 1.8 | | 02.96 - | Honda | 4 | 1,1 | ZFR6F-11 | 4291 | | LPG 6 | 1565 |
| 620 | 2.0 | 85 | 04.93 - | HONDA | 4 | 1,1 | ZFR6F-11 | 4291 | | LPG 6 | 1565 |
| 620 SDi, SLDi TD | 2.0 | | 10.95 - 99 | 20 T2R, 20T2N (Intercooled) | 4 | █ | Y-730U | 6704 | | D-POWER 17 | 6704 |
| 620 Turbo | 2.0 | | 94 - | T Series | 4 | 0,9 | BKR6E | 6962 | 28 | LPG 1 | 1496 |
| 623 | 2.3 | 116 | 04.94 - | HONDA | 4 | 1,1 | ZFR6F-11 | 4291 | | LPG 6 | 1565 |
| 75 | 1.8 | 87 | 02.99 - | K Series | 4 | 1,0 | PFR6N-11 | 3546 | | LPG 1 | 1496 |
| 75 | 2.0 | 109 | 02.99 - | K V6 | 6 | 1,0 | PFR6N-11 | 3546 | | LPG 1 | 1496 |
| 75 | 2.0 | | 02.99 - | M47R (BMW) | 4 | █ | Y-507J | 2691 | | D-POWER 32 | 2691 |
| 75 | 2.5 | 128 | 02.99 - | K V6 | 6 | 1,0 | PFR6N-11 | 3546 | | LPG 1 | 1496 |
| 75 2.0 CDT | 2.0 | 85 | 99 - | M47R (BMW) | 4 | █ | Y-507J | 2691 | | D-POWER 32 | 2691 |
| 75 Turbo | 1.8 | | 07.02 - | K Series | 4 | 1,1 | PFR6N-11 | 3546 | | LPG 1 | 1496 |
| 820 | 2.0 | | 07.86 - 10.91 | M16 Inj. | 4 | 0,9 | BKR6E | 6962 | 28 | LPG 1 | 1496 |
| 820 | 2.0 | | 03.91 - 10.91 | M16 Turbo Inj. | 4 | 0,9 | BKR6E | 6962 | 28 | LPG 1 | 1496 |
| 820 | 2.0 | | 11.91 - | T16 / Turbo/ Inj. | 4 | 0,9 | BKR6E | 6962 | 28 | LPG 1 | 1496 |
| 820 | 2.0 | | 05.88 - 09.90 | Vergaser/Carb. | 4 | 0,8 | BPR6ES | 7822 | 2 | LPG 2 | 1497 |
| 820 E,SE | 2.0 | 88 | 10.86 - 90 | M16E | 4 | 0,8 | BCPR6ES | 2330 | 12 | LPG 3 | 1498 |
| 820 i | 2.0 | | 91 - | 20T4 MPI | 4 | 0,9 | BKR6E | 6962 | 28 | LPG 1 | 1496 |
| 820 i,Si | 2.0 | 98 | 10.86 - 90 | M16i | 4 | 0,8 | BCPR6ES | 2330 | 12 | LPG 3 | 1498 |
| 820 Turbo | 2.0 | 132 | 10.92 - | 20T4 TURBO MPI | 4 | 0,9 | BKR6E | 6962 | 28 | LPG 1 | 1496 |
| 825 | 2.5 | | 07.86 - 02.88 | | 6 | 1,1 | BCPR6E-11 | 3132 | 11 | LPG 3 | 1498 |
| 825 | 2.5 | | 03.96 - 10.99 | VM | 4 | █ | Y-741U | 6943 | | D-POWER 20 | 6943 |
| 825 D/SD/SLD | 2.5 | | 90 - 03.96 | VM | 4 | █ | Y-924J | 7906 | | D-POWER 1 | 7906 |
| 825 i | 2.5 | | 01.96 - | KV6 | 6 | 0,9 | BKR6E | 6962 | 28 | LPG 1 | 1496 |
| 825 SD TD | 2.5 | 87 | 01.93 - | VM HR-492/VM 425 SLIRR | 4 | █ | Y-923U | 3380 | | D-POWER 1 | 7906 |
| 827 | 2.7 | | 02.88 - 01.96 | C27A V6 | 6 | 1,1 | BCPR6E-11 | 3132 | 11 | LPG 3 | 1498 |
| 90, 110 D | | | 01.83 - | | 4 | █ | Y-208T | 1250 | | | |
| City Rover 1.4 | 1.4 | | 10.03 - | K Series | 4 | 0,8 | BK6E | 3536 | | LPG 1 | 1496 |
| FL 2 / R (Hire Car) D | | | 08.83 - | | | █ | Y-208T | 1250 | | | |
| FX 4R Taxi D | | | 08.83 - | | | █ | Y-208T | 1250 | | | |
| Maestro | 1.3 | 51 | 03.89 - 12.94 | | 4 | 0,8 | BPR6ES | 7822 | 2 | LPG 2 | 1497 |
| Maestro | 1.6 | 63 | 07.89 - 04.92 | S Series | 4 | 0,8 | BCPR6ES | 2330 | 12 | LPG 3 | 1498 |
| Maestro | 1.6 | | -05.84 | R Series | 4 | 0,7 | BP6ES | 7811 | 4 | LPG 2 | 1497 |
| Maestro 500/700 D | | | 86 - 89 | | 4 | █ | Y-924J | 7906 | | D-POWER 1 | 7906 |
| Maestro TD | 2.0 | 60 | 07.89 - | Perkins-Prima 80 T | 4 | █ | Y-924J | 7906 | | D-POWER 1 | 7906 |
| Maestro Van TD | 2.0 | 60 | 01.86 - | | 4 | █ | Y-924J | 7906 | | D-POWER 1 | 7906 |
| Metro | 1.1 | | 05.90 - 12.94 | K8 | 4 | 0,9 | BKR6E | 6962 | 28 | LPG 1 | 1496 |
| Metro /16V/16V GTI | 1.4 | | 05.90 - 01.95 | K8/K16/K16 | 4 | 0,9 | BKR6E | 6962 | 28 | LPG 1 | 1496 |
| Metro D | 1.4 | 39 | 01.92 - 01.95 | Peugeot TUD 3 | 4 | █ | Y-910J | 3617 | | D-POWER 3 | 3617 |
| MG RV8 | 3.9 | 140 | 94 - | V8i | 8 | 0,8 | BPR6ES | 7822 | 2 | LPG 2 | 1497 |
| Mini | 1.0 | | 10.89 - 04.92 | | 4 | 0,8 | BPR6ES | 7822 | 2 | LPG 2 | 1497 |
| Mini | 1.3 | | 10.89 - | not Turbo | 4 | 0,8 | BPR6ES | 7822 | 2 | LPG 2 | 1497 |
| Mini | 1.3 | | 10.89 - 01.90 | Turbo | 4 | 0,8 | BPR7ES | 2023 | 19 | BPR7EIX | 4055 |
| Mini Cooper i | 1.3 | 46 | 91 - | 12A2EF77/SPI | 4 | 0,8 | BPR6ES | 7822 | 2 | LPG 2 | 1497 |
| Montego | 1.4 | | 12.94 - | | 4 | 0,7 | BCP6ES | 4930 | 17 | LPG 3 | 1498 |
| Montego | 1.6 | | 04.89 - 01.93 | | 4 | 0,8 | BCPR6ES | 2330 | 12 | LPG 3 | 1498 |
| Montego | 2.0 | | 04.89 - 12.94 | | 4 | 0,8 | BPR6ES | 7822 | 2 | LPG 2 | 1497 |



l kW



Cyl.

Order-
No. No.

VLINE

LPG/CNG
D-PowerOrder-
No.**ROVER**

| | | | | | | | | | | | |
|-------------------|-----|-----|---------------|--------------------|---|-----|-----------|------|----|------------|------|
| Montego TD | 2.0 | 60 | 09.88 - | Perkins-Prima 80 T | 4 | █ | Y-924J | 7906 | | D-POWER 1 | 7906 |
| Sterling | 2.5 | | 10.87 - | C25A V6 | 6 | 0,8 | BCPR6ES | 2330 | 12 | LPG 3 | 1498 |
| Sterling | 2.7 | | 02.88 - | C27A V6 | 6 | 1,1 | BCPR6E-11 | 3132 | 11 | LPG 3 | 1498 |
| Streetwise 1.4 | 1.4 | | 07.03 - | K Series | 4 | 1,1 | PFR6N-11 | 3546 | | LPG 1 | 1496 |
| Streetwise 1.4 | 1.4 | | 07.03 - | K Series | 4 | 1,1 | PFR6N-11 | 3546 | | LPG 1 | 1496 |
| Streetwise 1.6 | 1.6 | | 07.03 - | K Series | 4 | 1,1 | PFR6N-11 | 3546 | | LPG 1 | 1496 |
| Streetwise 1.8 | 1.8 | | 07.03 - | K Series | 4 | 1,1 | PFR6N-11 | 3546 | | LPG 1 | 1496 |
| Streetwise 2.0 TD | 2.0 | | 07.03 - | | 4 | █ | Y-730U | 6704 | | D-POWER 17 | 6704 |
| Tourer 1.6 | 1.6 | 80 | 03.96 - 04.99 | K Series | 4 | 0,8 | BKR6ES | 3783 | 28 | LPG 1 | 1496 |
| Vanden Plas EFi | 1.6 | 75 | 03.85 - 09.89 | S-Series | 4 | 1,1 | BCPR6E-11 | 3132 | 11 | LPG 3 | 1498 |
| Vitesse | 1.6 | 75 | 03.85 - 09.89 | S-Series | 4 | 0,8 | BCPR6ES | 2330 | 12 | LPG 3 | 1498 |
| Vitesse i | 3.5 | 139 | 10.82 - 10.86 | V8 | 8 | 0,8 | BPR6ES | 7822 | 2 | LPG 2 | 1497 |

SAAB

| | | | | | | | | | | | |
|----------------------------|-----|-----|---------------|---------------------|---|-----|------------|------|----|-----------|------|
| 600 | 1.5 | | 80 - 86 | | 4 | 0,8 | BPR6ES | 7822 | 2 | LPG 2 | 1497 |
| 90 | 2.0 | 74 | 08.84 - 08.87 | B201C / XC | 4 | 0,7 | BP6ES | 7811 | 4 | LPG 2 | 1497 |
| 900 | 2.0 | 74 | - 93 | B201C | 4 | 0,7 | BP6ES | 7811 | 4 | LPG 2 | 1497 |
| 900 | 2.0 | 96 | 08.94 - 02.98 | B204i | 4 | 0,7 | BCP5EVX | 5664 | | LPG 3 | 1498 |
| 900 | 2.0 | 136 | 10.93 - | B204L | 4 | 1,1 | BCPR7ES-11 | 1095 | | BCPR7EIX | 5690 |
| 900 | 2.0 | | - 93 | B202 | 4 | 0,7 | BCP5EVX | 5664 | | LPG 3 | 1498 |
| 900 | 2.0 | | - 93 | B212 | 4 | 0,7 | BCP5EVX | 5664 | | LPG 3 | 1498 |
| 900 | 2.3 | 110 | 10.93 - | B234I | 4 | 0,7 | BCP6EVX | 6323 | | LPG 3 | 1498 |
| 900 | 2.5 | 125 | 94 - | B258 Motronic | 6 | | BKR5EK | 7956 | 23 | LPG 1 | 1496 |
| 900 | 2.5 | | 10.93 - | B258i, B308i | 6 | | BKR6EK | 2288 | 20 | LPG 1 | 1496 |
| 900 S/Cabrio. | 2.0 | | - 93 | B202S | 4 | 0,6 | BCP7EVX | 7681 | | BCPR7EIX | 5690 |
| 900 Turbo | 2.0 | | 83 - 93 | B201 mit / with APC | 4 | 0,8 | BP7EVX | 7270 | | BPR8EIX | 6684 |
| 900 Turbo | 2.0 | | 81 - 82 | B201 ohne APC | 4 | 0,8 | BP7ES | 2412 | | BPR8EIX | 6684 |
| 900 Turbo 16V | 2.0 | | - 93 | B202 | 4 | 0,8 | BCP7EVX | 7681 | | BCPR7EIX | 5690 |
| 900 Turbo 16V/S/SE/Cabrio. | 2.0 | | | B202L | 4 | 0,6 | BCP7EVX | 7681 | | BCPR7EIX | 5690 |
| 9000 | 2.0 | 87 | 09.84 - 12.98 | B202L | 4 | 1,1 | BCPR7ES-11 | 1095 | | BCPR7EIX | 5690 |
| 9000 | 2.0 | 96 | 94 - 98 | B204i | 4 | 1,1 | BCPR6ES-11 | 7121 | 11 | LPG 3 | 1498 |
| 9000 | 2.0 | 110 | 94 - 98 | B204 E | 4 | 1,1 | BCPR7ES-11 | 1095 | | BCPR7EIX | 5690 |
| 9000 | 2.0 | | 94 - 96 | B202 mit Di | 4 | 0,8 | BCPR7ES | 3330 | | BCPR7EIX | 5690 |
| 9000 | 2.0 | | - 93 | B202i ohne Di | 4 | 0,7 | BCP5EVX | 5664 | | LPG 3 | 1498 |
| 9000 | 2.0 | | 94 - 96 | B202S mit Di | 4 | 0,8 | BCPR7ES | 3330 | | BCPR7EIX | 5690 |
| 9000 | 2.3 | 96 | 94 - 96 | B234I | 4 | 0,7 | BCP6EVX | 6323 | | LPG 3 | 1498 |
| 9000 | 2.3 | 125 | 94 - 98 | B234 E | 4 | 1,1 | BCPR7ES-11 | 1095 | | BCPR7EIX | 5690 |
| 9000 | 2.3 | 147 | 92 - 98 | B234L | 4 | 1,1 | BCPR7ES-11 | 1095 | | BCPR7EIX | 5690 |
| 9000 CDi-16 | 2.0 | | | B202i | 4 | 0,7 | BCP6EVX | 6323 | | LPG 3 | 1498 |
| 9000 Aero | 2.3 | 165 | 93 - 98 | B234R | 4 | 1,1 | BCPR7ES-11 | 1095 | | BCPR7EIX | 5690 |
| 9000 CS 2.3-16 | 2.3 | 107 | 09.91 - | B234I Cat. | 4 | 1,1 | BCPR6ES-11 | 7121 | 11 | LPG 3 | 1498 |
| 9000 V6 | 3.0 | 155 | 11.94 - | B308 V6 | 6 | | BKR5EK | 7956 | 23 | LPG 1 | 1496 |
| 9-3 | 1.8 | 90 | 03.05 - | Z18XE | 4 | | BKR5EQUA | 3566 | | | |
| 9-3 | 2.0 | 96 | 02.98 - | B204Ei | 4 | 0,7 | BCP5EVX | 5664 | | LPG 3 | 1498 |
| 9-3 | 2.0 | 110 | 10.98 - | B204E | 4 | 1,1 | BCPR7ES-11 | 1095 | | BCPR7EIX | 5690 |
| 9-3 | 2.0 | 110 | 09.02 - | L 850 | 4 | | PFR6T-10G | 5542 | | PFR6T-10G | 5542 |
| 9-3 | 2.0 | 136 | 98 - 99 | B204L | 4 | 1,1 | BCPR7ES-11 | 1095 | | BCPR7EIX | 5690 |
| 9-3 | 2.0 | 136 | 00 - | B205L | 4 | 1,0 | PFR6H-10 | 6290 | | PFR7H-10 | 3978 |
| 9-3 | 2.0 | 147 | 08.98 - 99 | B204R | 4 | 1,1 | BCPR7ES-11 | 1095 | | BCPR7EIX | 5690 |
| 9-3 | 2.0 | 150 | 00 - | B205R | 4 | 1,0 | PFR6H-10 | 6290 | | PFR7H-10 | 3978 |
| 9-3 | 2.3 | 110 | 02.98 - 12.98 | B234I | 4 | 0,7 | BCP6EVX | 6323 | | LPG 3 | 1498 |
| 9-3 | 2.3 | 169 | 10.99 - 09.01 | B235R | 4 | 1,0 | PFR6H-10 | 6290 | | PFR7H-10 | 3978 |



ℓ kW

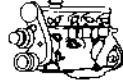

Cyl.

Order-
No.LPG/CNG
D-PowerOrder-
No.**SAAB**

| | | | | | | | | | | | |
|---------------------|-----|-----|-------------|----------------|---|-----|------------|------|----|------------|------|
| 9-3 | 2.5 | 125 | 98 - | B258 Motronic | 6 | | BKR5EK | 7956 | 23 | LPG 1 | 1496 |
| 9-3 16V Pack | 2.0 | 96 | 04.98 - | B204i | 4 | 0,7 | BCP5EVX | 5664 | | | |
| 9-3 Bio Power | 2.0 | 129 | | B207L | 4 | 1,1 | BKR7ESC-11 | 6313 | | | |
| 9-3 Turbo | 2.0 | 129 | 09.02 - | B207E | 4 | | PFR6T-10G | 5542 | | PFR6T-10G | 5542 |
| 9-3 Turbo | 2.0 | 154 | 09.02 - | B207R | 4 | | PFR6T-10G | 5542 | | PFR6T-10G | 5542 |
| 9-3 Turbo Bio Power | 1.8 | 129 | 09.06 - | | 4 | 1,1 | BCPR7ES-11 | 1095 | | BCPR7EIX | 5690 |
| 93 / 95 / 96 | | | | 2 Takter | 3 | 0,6 | AB7 | 3010 | | | |
| 9-3 Aero Turbo | 2.8 | 169 | 04.05 - | B284E HFV6 | 6 | 1,0 | PLFR6C-10G | 1959 | | PLFR6C-10G | 1959 |
| 9-3 Aero Turbo | 2.8 | 184 | 03.05 - | B284L HFV6 | 6 | 1,0 | PLFR6C-10G | 1959 | | PLFR6C-10G | 1959 |
| 9-3 t | 1.8 | 110 | 09.02 - | B207L | 4 | | PFR6T-10G | 5542 | | PFR6T-10G | 5542 |
| 9-3 TiD | 1.9 | 88 | 03.05 - | Z19DT Fiat | 4 | █ | Y-534J | 3413 | | D-POWER 36 | 3413 |
| 9-3 TiD | 1.9 | 110 | 03.05 - | Z19DTH Fiat | 4 | █ | YE07 | 6092 | | | |
| 9-3 TiD | 2.2 | 85 | 09.98 - | X22DTH Opel | 4 | █ | Y-748U | 6649 | | D-POWER 14 | 6649 |
| 9-3 TiD | 2.2 | 92 | 03 - | D223L | 4 | █ | Y-523J | 6298 | | D-POWER 37 | 6298 |
| 9-3 TTiD | 1.9 | 132 | 05 - | | 4 | █ | Y-534J | 3413 | | D-POWER 36 | 3413 |
| 9-3 Turbo Bio Power | 2.0 | 147 | 07.07 - | B207 / Z20NFL | 4 | 1,1 | BKR7ESC-11 | 6313 | | | |
| 9-5 | 2.0 | 110 | 09.97 - | B205E | 4 | 1,1 | BCPR7ES-11 | 1095 | | BCPR7EIX | 5690 |
| 9-5 | 2.0 | 140 | 09.97 - | B205E Trim Kit | 4 | 1,0 | PFR6H-10 | 6290 | | PFR7H-10 | 3978 |
| 9-5 | 2.3 | 125 | 09.97 - | B235E | 4 | 1,1 | BCPR6ES-11 | 7121 | 11 | LPG 3 | 1498 |
| 9-5 | 2.3 | 162 | 07.03 - | B235L | 4 | 1,0 | PFR6H-10 | 6290 | | PFR7H-10 | 3978 |
| 9-5 | 2.3 | 165 | 07.98 - | B235R | 4 | 1,0 | PFR6H-10 | 6290 | | PFR7H-10 | 3978 |
| 9-5 | 2.3 | 169 | 10.99-09.01 | B235R | 4 | 1,0 | PFR6H-10 | 6290 | | PFR7H-10 | 3978 |
| 9-5 | 2.3 | 184 | 10.99 - | B235R | 4 | 1,0 | PFR6H-10 | 6290 | | PFR7H-10 | 3978 |
| 9-5 Bio Power | 2.0 | 132 | 07.07 - | A20NHL | 4 | 1,1 | BKR7ESC-11 | 6313 | | | |
| 9-5 Bio Power | 2.0 | 162 | 11 - | A20NFT | 4 | 1,0 | PFR6D10G | 1632 | | | |
| 9-5 Bio Power | 2.0 | 162 | | A20NHT | 4 | 1,0 | PFR6D10G | 1632 | | | |
| 9-5 Bio Power | 2.3 | 155 | 09.06 - | | 4 | 1,1 | BCPR7ES-11 | 1095 | | BCPR7EIX | 5690 |
| 9-5 t SE | 2.0 | 136 | 01.01 - | B205L | 4 | 1,0 | PFR6H-10 | 6290 | | PFR7H-10 | 3978 |
| 9-5 TiD | 1.9 | 110 | 06 - | Z19DTH Fiat | 4 | █ | YE07 | 6092 | | | |
| 9-5 TiD | 2.2 | 88 | 01.02 - | D223L | 4 | █ | Y-748U | 6649 | | D-POWER 14 | 6649 |
| 9-5 Turbo | 2.3 | 191 | 11.05 - | B235R | 4 | 1,0 | PFR6H-10 | 6290 | | PFR7H-10 | 3978 |
| 9-5 V6 | 3.0 | 147 | 09.97 - | B308E | 6 | 1,1 | BKR7ES-11 | 2387 | | BKR8EIX | 2668 |
| 99 | 2.0 | 63 | 09.82-12.84 | F201C | 4 | 0,7 | BP6ES | 7811 | 4 | LPG 2 | 1497 |
| 99 | 2.0 | 74 | 09.83-12.84 | B201 | 4 | 0,7 | BP6ES | 7811 | 4 | LPG 2 | 1497 |
| 99 GL | 2.0 | 74 | 09.81-12.84 | B20C | 4 | 0,7 | BP6ES | 7811 | 4 | LPG 2 | 1497 |

SAM SUNG

| | | | | | | | | | | | |
|----------|-----|--|--|----------|---|-----|----------|------|--|----------|------|
| SM518 | 1.8 | | | DOHC | 4 | 1,1 | PFR5G-11 | 2647 | | PFR6G-11 | 5555 |
| SM520 | 2.0 | | | DOHC | 4 | 1,1 | PFR5G-11 | 2647 | | PFR6G-11 | 5555 |
| SM520 | 2.0 | | | DOHC LPG | 4 | | LPG 1 | 1496 | | LPG 1 | 1496 |
| SM520 V6 | 2.0 | | | DOHC | 6 | 1,1 | PFR5G-11 | 2647 | | PFR6G-11 | 5555 |
| SM525 V6 | 2.5 | | | DOHC | 6 | 1,1 | PFR5G-11 | 2647 | | PFR6G-11 | 5555 |

SEAT

| | | | | | | | | | | | |
|----------|-----|-----|-------------|-----|---|-----|------------|------|----|-----------|------|
| 131 D | 2.5 | 52 | 06.82-12.84 | | 4 | █ | Y-208T | 1250 | | | |
| Alhambra | 1.8 | 110 | 05.98-02.00 | AJH | 4 | | BKR6ETA-10 | 7998 | | | |
| Alhambra | 1.8 | 110 | 06.00 - | AWC | 4 | 0,8 | PFR6Q | 6458 | 37 | LPG 1 | 1496 |
| Alhambra | 1.9 | 66 | 06.00 - | ANU | 4 | █ | Y-732J | 5605 | | D-POWER 4 | 5605 |
| Alhambra | 2.0 | 85 | 03.96-02.00 | ADY | 4 | | BKUR6ET | 6437 | 27 | LPG 1 | 1496 |
| Alhambra | 2.0 | 85 | 06.00 - | ATM | 4 | | BKUR6ET-10 | 2397 | 24 | LPG 1 | 1496 |
| Alhambra | 2.8 | 128 | 06.96 - | AAA | 6 | | BKR5EKUP | 2890 | | | |
| Alhambra | 2.8 | 150 | 06.00-04.02 | AUE | 6 | 1,1 | PZFR5D-11 | 7968 | 34 | LPG 6 | 1565 |



ℓ kW



Cyl.

Order-
No. No.LPG/CNG
D-PowerOrder-
No.**SEAT**

| | | | | | | | | | | | |
|------------------------------|-----|-----|---------------|------|---|-----|------------|------|----|------------|------|
| Alhambra | 2.8 | 150 | 06.00 - | AYL | 6 | 1,1 | PZFR5D-11 | 7968 | 34 | LPG 6 | 1565 |
| Alhambra TDI | 1.9 | 66 | 04.95 - 07.96 | 1Z | 4 | █ | Y-732J | 5605 | | D-POWER 4 | 5605 |
| Alhambra TDI | 1.9 | 66 | 07.96 - 02.00 | AHU | 4 | █ | Y-732J | 5605 | | D-POWER 4 | 5605 |
| Alhambra TDI | 1.9 | 81 | 09.97 - 02.00 | AFN | 4 | █ | Y-732J | 5605 | | D-POWER 4 | 5605 |
| Alhambra TDI | 1.9 | 85 | 06.00 - | AUY | 4 | █ | Y-732J | 5605 | | D-POWER 4 | 5605 |
| Alhambra TDI | 1.9 | 96 | 06.05 - 05.06 | ASZ | 4 | █ | Y-741U | 6943 | | D-POWER 20 | 6943 |
| Alhambra TDI | 2.0 | 103 | 11.05 - | BRT | 4 | █ | CZ104 | 9826 | | D-POWER 52 | 9826 |
| Altea | 1.4 | 63 | 05.06 - | BXW | 4 | 1,1 | ZFR6T-11G | 5960 | | ZFR6T-11G | 5960 |
| Altea | 1.6 | 75 | 03.04 - 05.05 | BGU | 4 | | BKUR6ET-10 | 2397 | 24 | LPG 1 | 1496 |
| Altea | 1.6 | 75 | 05.05 - | BSE | 4 | | BKUR6ET-10 | 2397 | 24 | LPG 1 | 1496 |
| Altea | 1.6 | 75 | 05.05 - 09 | BSF | 4 | | BKUR6ET-10 | 2397 | 24 | LPG 1 | 1496 |
| Altea | 1.6 | 75 | 12.07 - | CCSA | 4 | | BKUR6ET-10 | 2397 | 24 | LPG 1 | 1496 |
| Altea | 2.0 | 110 | 05.04 - 11.05 | BLR | 4 | | PZFR5N-11T | 7742 | | PZFR5N-11T | 7742 |
| Altea | 2.0 | 110 | 11.04 - 11.05 | BLY | 4 | 0,9 | BKR6E | 6962 | 28 | LPG 1 | 1496 |
| Altea FSI | 1.4 | 92 | 11.07 - | CAXC | 4 | | PZFR6R | 5758 | | PZFR6R | 5758 |
| Altea FSI | 1.8 | 118 | 01.07 - 06.07 | BYT | 4 | | PFR7S8EG | 1675 | | | |
| Altea FSI | 1.8 | 118 | 06.07 - 03.09 | BZB | 4 | | PFR7S8EG | 1675 | | | |
| Altea FSI 16V | 2.0 | 110 | 11.05 - | BVY | 4 | | PZFR5N-11T | 7742 | | PZFR5N-11T | 7742 |
| Altea FSI 16V | 2.0 | 110 | 11.05 - | BVZ | 4 | 0,9 | BKR6E | 6962 | 28 | LPG 1 | 1496 |
| Altea TDI | 1.9 | 66 | 08.09 - | BXF | 4 | █ | Y-607AS | 7560 | | D-POWER 50 | 7560 |
| Altea TDI | 1.9 | 77 | 04.04 - 09.05 | BJB | 4 | █ | Y-607AS | 7560 | | D-POWER 50 | 7560 |
| Altea TDI | 1.9 | 77 | 04.04 - 05.06 | BKC | 4 | █ | Y-607AS | 7560 | | D-POWER 50 | 7560 |
| Altea TDI | 1.9 | 77 | 10.05 - | BLS | 4 | █ | CZ104 | 9826 | | D-POWER 52 | 9826 |
| Altea TDI | 1.9 | 77 | 02.06 - | BXE | 4 | █ | Y-607AS | 7560 | | D-POWER 50 | 7560 |
| Altea TDI | 2.0 | 100 | 04.04 - 05.09 | AZV | 4 | █ | YE14 | 7768 | | D-POWER 48 | 7768 |
| Altea TDI | 2.0 | 103 | 11.05 - | BMM | 4 | █ | Y-607AS | 7560 | | D-POWER 50 | 7560 |
| Altea TDI | 2.0 | 103 | 03.04 - | BKD | 4 | █ | YE14 | 7768 | | D-POWER 48 | 7768 |
| Altea TDI | 2.0 | 125 | 03.09 - 09.10 | CEGA | 4 | █ | Y-609AS | 5849 | | D-POWER 49 | 5849 |
| Altea TDI | 2.0 | 125 | 02.06 - | BMN | 4 | █ | CZ304 | 9864 | | D-POWER 55 | 9864 |
| Altea TFSI | 1.8 | 118 | 03.09 - | CDAА | 4 | | PFR7S8EG | 1675 | | | |
| Altea TFSI | 2.0 | 147 | 02.06 - 05.09 | BWA | 4 | | PFR7S8EG | 1675 | | | |
| Arosa | 1.0 | 37 | 02.97 - 09.99 | AER | 4 | | BUR6ET | 3172 | 1 | LPG 2 | 1497 |
| Arosa | 1.0 | 37 | 11.98 - 02.00 | AHT | 4 | | BKR6ETA-10 | 7998 | | | |
| Arosa | 1.0 | 37 | 07.99 - 07.00 | ALD | 4 | 1,1 | PZFR5D-11 | 7968 | 34 | LPG 6 | 1565 |
| Arosa | 1.0 | 37 | 08.97 - 06.99 | ALL | 4 | | BUR6ET | 3172 | 1 | LPG 2 | 1497 |
| Arosa | 1.0 | 37 | 07.99 - 07.00 | ANV | 4 | 1,1 | PZFR5D-11 | 7968 | 34 | LPG 6 | 1565 |
| Arosa | 1.0 | 37 | 07.00 - 06.04 | AUC | 4 | 1,1 | PZFR5D-11 | 7968 | 34 | LPG 6 | 1565 |
| Arosa | 1.4 | 44 | 02.97 - 11.97 | AEX | 4 | | BUR6ET | 3172 | 1 | LPG 2 | 1497 |
| Arosa | 1.4 | 44 | 07.99 - 10.00 | AKK | 4 | 1,1 | PZFR5D-11 | 7968 | 34 | LPG 6 | 1565 |
| Arosa | 1.4 | 44 | 05.97 - 09.99 | AKV | 4 | | BUR6ET | 3172 | 1 | LPG 2 | 1497 |
| Arosa | 1.4 | 44 | 07.99 - 10.00 | ANW | 4 | 1,1 | PZFR5D-11 | 7968 | 34 | LPG 6 | 1565 |
| Arosa | 1.4 | 44 | 12.97 - 08.99 | APQ | 4 | | BUR6ET | 3172 | 1 | LPG 2 | 1497 |
| Arosa | 1.4 | 44 | 09.00 - 06.04 | AUD | 4 | 1,1 | PZFR5D-11 | 7968 | 34 | LPG 6 | 1565 |
| Arosa 16V | 1.4 | 55 | 01.98 - | AHW | 4 | | BKUR6ET-10 | 2397 | 24 | LPG 1 | 1496 |
| Arosa 16V | 1.4 | 74 | 01.99 - 09.00 | AFK | 4 | | BKUR6ET-10 | 2397 | 24 | LPG 1 | 1496 |
| Arosa 16V | 1.4 | 74 | 01.99 - | ANM | 4 | | BKUR6ET-10 | 2397 | 24 | LPG 1 | 1496 |
| Arosa 16V | 1.4 | 74 | 10.99 - 09.00 | AQQ | 4 | | BKUR6ET-10 | 2397 | 24 | LPG 1 | 1496 |
| Arosa 16V | 1.4 | 74 | 09.00 - 06.04 | AUB | 4 | | BKUR6ET-10 | 2397 | 24 | LPG 1 | 1496 |
| Arosa SDI | 1.7 | 44 | 08.97 - 10.03 | AKU | 4 | █ | Y-732J | 5605 | | D-POWER 4 | 5605 |
| Arosa TDI Fgst >6H-2-009 700 | 1.4 | 55 | 09.99 - 06.04 | AMF | 3 | █ | Y-732J | 5605 | | D-POWER 4 | 5605 |
| Arosa TDI Fgst 6H-2-009 701> | 1.4 | 55 | 09.99 - 06.04 | AMF | 3 | █ | Y-741U | 6943 | | D-POWER 20 | 6943 |
| Cordoba | 1.0 | 37 | 07.00 - | AUC | 4 | 1,1 | PZFR5D-11 | 7968 | 34 | LPG 6 | 1565 |

Fgst = Chassis No.



ℓ kW



Cyl.

Order-
No.VLINE
No.LPG/CNG
D-PowerOrder-
No.**SEAT**

| | | | | | | | | | | | | |
|------------------------|-----|-----|---------------|-----|---|-----|-------------|------|----|------------|--|------|
| Cordoba | 1.0 | 51 | 05.00 - | AVZ | 4 | | BKUR6ETB-10 | 5742 | | | | |
| Cordoba | 1.3 | 40 | 02.93 - 08.94 | 2G | 4 | | BUR6ET | 3172 | 1 | LPG 2 | | 1497 |
| Cordoba | 1.3 | 40 | 02.93 - 08.94 | AAV | 4 | | BP5ET | 2287 | | | | |
| Cordoba | 1.4 | 40 | 01.98 - | ANX | 4 | | BUR6ET | 3172 | 1 | LPG 2 | | 1497 |
| Cordoba | 1.4 | 44 | 09.93 - 12.95 | ABD | 4 | | BP5ET | 2287 | | | | |
| Cordoba | 1.4 | 63 | 05.06 - | BXW | 4 | 1,1 | ZFR6T-11G | 5960 | | ZFR6T-11G | | 5960 |
| Cordoba | 1.6 | 52 | 11.93 - | ABM | 4 | | BUR5ET | 3377 | 22 | LPG 2 | | 1497 |
| Cordoba | 1.6 | 55 | 02.93 - 07.94 | ABU | 4 | | BUR6ET | 3172 | 1 | LPG 2 | | 1497 |
| Cordoba | 1.6 | 74 | | | 4 | | BUR5ET | 3377 | 22 | LPG 2 | | 1497 |
| Cordoba | 1.6 | 74 | 01.96 - | AEK | 4 | | BKUR5ET | 2789 | 29 | LPG 1 | | 1496 |
| Cordoba | 1.6 | 74 | 05.99 - 08.02 | AKL | 4 | | BKUR6ET-10 | 2397 | 24 | LPG 1 | | 1496 |
| Cordoba | 1.6 | 77 | 11.06 - | BTS | 4 | 1,1 | ZFR6T-11G | 5960 | | ZFR6T-11G | | 5960 |
| Cordoba | 1.8 | 55 | 08.91 - | AAM | 4 | | BUR5ET | 3377 | 22 | LPG 2 | | 1497 |
| Cordoba | 1.8 | 66 | 02.93 - 08.94 | ABS | 4 | | BUR6ET | 3172 | 1 | LPG 2 | | 1497 |
| Cordoba | 1.8 | 66 | 07.96 - | ACC | 4 | | BUR6ET | 3172 | 1 | LPG 2 | | 1497 |
| Cordoba | 1.8 | 95 | 02.94 - 06.96 | ADL | 4 | | BKUR7ET | 7873 | | PFR7Q | | 7963 |
| Cordoba | 1.8 | 115 | 09.00 - | AYP | 4 | | BKUR6ET-10 | 2397 | 24 | LPG 1 | | 1496 |
| Cordoba | 2.0 | 85 | 02.93 - 06.96 | 2E | 4 | | BUR6ET | 3172 | 1 | LPG 2 | | 1497 |
| Cordoba | 2.0 | 85 | 09.02 - | AZL | 4 | | BKUR6ET-10 | 2397 | 24 | LPG 1 | | 1496 |
| Cordoba | 2.0 | 85 | 04.03 - | BBX | 4 | | BKUR6ET-10 | 2397 | 24 | LPG 1 | | 1496 |
| Cordoba 16 V | 1.4 | 55 | 05.04 - | BKY | 4 | | BKUR6ET-10 | 2397 | 24 | LPG 1 | | 1496 |
| Cordoba 16 V | 1.4 | 74 | 05.05 - | BBZ | 4 | | BKUR6ET-10 | 2397 | 24 | LPG 1 | | 1496 |
| Cordoba 16 V | 1.8 | 100 | | | 4 | | BUR6ET | 3172 | 1 | LPG 2 | | 1497 |
| Cordoba 16 V Automatic | 1.4 | 55 | 09.02 - 04.04 | BBY | 4 | 1,1 | PZFR5D-11 | 7968 | 34 | LPG 6 | | 1565 |
| Cordoba 16 V Automatic | 1.4 | 55 | 05.04 - | BKY | 4 | 1,1 | PZFR5D-11 | 7968 | 34 | LPG 6 | | 1565 |
| Cordoba 16V | 1.4 | 55 | 05.99 - 06.00 | APE | 4 | | BKUR6ET-10 | 2397 | 24 | LPG 1 | | 1496 |
| Cordoba 16V | 1.4 | 55 | 06.00 - | AUA | 4 | | BKUR6ET-10 | 2397 | 24 | LPG 1 | | 1496 |
| Cordoba 16V | 2.0 | 110 | 07.96 - | ABF | 4 | | BKUR6ET-10 | 2397 | 24 | LPG 1 | | 1496 |
| Cordoba 20V | 1.8 | 115 | 12.99 - | AQX | 4 | | BKUR6ET-10 | 2397 | 24 | LPG 1 | | 1496 |
| Cordoba SDI | 1.9 | 47 | 09.02 - 04.04 | ASY | 4 | ☑ | Y-732J | 5605 | | D-POWER 4 | | 5605 |
| Cordoba SDI | 1.9 | 50 | 04.99 - 08.02 | AGP | 4 | ☑ | Y-732J | 5605 | | D-POWER 4 | | 5605 |
| Cordoba SDI | 1.9 | 50 | 06.99 - 08.02 | AQM | 4 | ☑ | Y-732J | 5605 | | D-POWER 4 | | 5605 |
| Cordoba TDI | 1.4 | 51 | 05.05 - | BNM | 3 | ☑ | Y-741U | 6943 | | D-POWER 20 | | 6943 |
| Cordoba TDI | 1.4 | 55 | 10.02 - 04.04 | AMF | 3 | ☑ | Y-741U | 6943 | | D-POWER 20 | | 6943 |
| Cordoba TDI | 1.4 | 58 | 05.05 - | BNV | 3 | ☑ | Y-741U | 6943 | | D-POWER 20 | | 6943 |
| Cordoba TDI | 1.4 | 59 | 06.06 - 12.06 | BMS | 3 | ☑ | CZ104 | 9826 | | D-POWER 52 | | 9826 |
| Cordoba TDI | 1.9 | 66 | 04.99 - 08.02 | AGR | 4 | ☑ | Y-732J | 5605 | | D-POWER 4 | | 5605 |
| Cordoba TDI | 1.9 | 66 | 10.99 - 05.01 | ALH | 4 | ☑ | Y-732J | 5605 | | D-POWER 4 | | 5605 |
| Cordoba TDI | 1.9 | 74 | 09.06 - 12.06 | BMT | 4 | ☑ | CZ104 | 9826 | | D-POWER 52 | | 9826 |
| Cordoba TDI | 1.9 | 74 | 09.02 - 04.04 | ATD | 4 | ☑ | Y-741U | 6943 | | D-POWER 20 | | 6943 |
| Cordoba TDI | 1.9 | 74 | 05.05 - | AXR | 4 | ☑ | Y-741U | 6943 | | D-POWER 20 | | 6943 |
| Cordoba TDI | 1.9 | 81 | 03.99 - 08.02 | ASV | 4 | ☑ | Y-732J | 5605 | | D-POWER 4 | | 5605 |
| Cordoba TDI | 1.9 | 96 | 10.02 - 04.04 | ASZ | 4 | ☑ | Y-741U | 6943 | | D-POWER 20 | | 6943 |
| Cordoba TDI | 1.9 | 96 | 05.05 - | BLT | 4 | ☑ | Y-741U | 6943 | | D-POWER 20 | | 6943 |
| Cordoba / Vario | 1.0 | 37 | 09.96 - | AER | 4 | | BUR6ET | 3172 | 1 | LPG 2 | | 1497 |
| Cordoba / Vario | 1.0 | 37 | 08.99 - 08.02 | ALD | 4 | 1,1 | PZFR5D-11 | 7968 | 34 | LPG 6 | | 1565 |
| Cordoba / Vario | 1.0 | 37 | 08.99 - 07.00 | ANV | 4 | 1,1 | PZFR5D-11 | 7968 | 34 | LPG 6 | | 1565 |
| Cordoba / Vario | 1.4 | 44 | 09.95 - 12.97 | AEX | 4 | | BUR6ET | 3172 | 1 | LPG 2 | | 1497 |
| Cordoba / Vario | 1.4 | 44 | 08.99 - 08.02 | AKK | 4 | 1,1 | PZFR5D-11 | 7968 | 34 | LPG 6 | | 1565 |
| Cordoba / Vario | 1.4 | 44 | 09.97 - | AKV | 4 | | BUR6ET | 3172 | 1 | LPG 2 | | 1497 |
| Cordoba / Vario | 1.4 | 44 | 05.99 - 08.00 | ANW | 4 | 1,1 | PZFR5D-11 | 7968 | 34 | LPG 6 | | 1565 |
| Cordoba / Vario | 1.4 | 44 | 12.97 - 05.98 | APQ | 4 | | BUR6ET | 3172 | 1 | LPG 2 | | 1497 |



ℓ kW

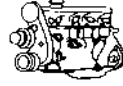

Cyl.

Order-
No. No.LPG/CNG
D-PowerOrder-
No.**SEAT**

| | | | | | | | | | | | |
|---------------------|-----|-----|---------------|-------|---|-----|------------|------|----|------------|------|
| Cordoba / Vario | 1.4 | 44 | 06.00 - | AUD | 4 | 1,1 | PZFR5D-11 | 7968 | 34 | LPG 6 | 1565 |
| Cordoba / Vario | 1.6 | 55 | 09.94 - 09.97 | 1F | 4 | | BUR5ET | 3377 | 22 | LPG 2 | 1497 |
| Cordoba / Vario | 1.6 | 55 | 05.97 - 12.98 | AEE | 4 | | BUR6ET | 3172 | 1 | LPG 2 | 1497 |
| Cordoba / Vario | 1.6 | 55 | 09.97 - 08.02 | ALM | 4 | | BUR6ET | 3172 | 1 | LPG 2 | 1497 |
| Cordoba / Vario | 1.6 | 74 | 05.99 - 08.02 | AEH | 4 | | BKUR6ET-10 | 2397 | 24 | LPG 1 | 1496 |
| Cordoba / Vario | 1.6 | 74 | 09.95 - 05.98 | AFT | 4 | | BKUR6ET-10 | 2397 | 24 | LPG 1 | 1496 |
| Cordoba / Vario | 1.6 | 74 | 03.00 - 10.00 | APF | 4 | | BKUR6ET-10 | 2397 | 24 | LPG 1 | 1496 |
| Cordoba / Vario | 1.6 | 74 | 05.00 - | AUR | 4 | | BKUR6ET-10 | 2397 | 24 | LPG 1 | 1496 |
| Cordoba / Vario | 1.8 | 66 | 07.94 - | ADZ | 4 | | BUR6ET | 3172 | 1 | LPG 2 | 1497 |
| Cordoba / Vario | 2.0 | 85 | 04.96 - | AGG | 4 | | BUR6ET | 3172 | 1 | LPG 2 | 1497 |
| Cordoba / Vario 16V | 1.4 | 74 | 06.97 - | AFH | 4 | | BKUR6ET | 6437 | 27 | LPG 1 | 1496 |
| Cordoba / Vario 16V | 1.4 | 74 | 09.99 - 07.00 | AQQ | 4 | | BKUR6ET-10 | 2397 | 24 | LPG 1 | 1496 |
| Cordoba / Vario 16V | 1.4 | 74 | 07.00 - | AUB | 4 | | BKUR6ET-10 | 2397 | 24 | LPG 1 | 1496 |
| Cordoba / Vario D | 1.9 | 47 | 02.93 - | 1Y | 4 | ▣ | Y-918J | 6285 | | D-POWER 2 | 6285 |
| Cordoba / Vario SDI | 1.9 | 47 | 07.96 - | AEY | 4 | ▣ | Y-732J | 5605 | | D-POWER 4 | 5605 |
| Cordoba / Vario TD | 1.9 | 55 | 02.93 - 08.97 | AAZ | 4 | ▣ | Y-918J | 6285 | | D-POWER 2 | 6285 |
| Cordoba / Vario TDI | 1.9 | 66 | 07.95 - 12.96 | 1Z | 4 | ▣ | Y-732J | 5605 | | D-POWER 4 | 5605 |
| Cordoba / Vario TDI | 1.9 | 66 | 12.96 - | AHU | 4 | ▣ | Y-732J | 5605 | | D-POWER 4 | 5605 |
| Cordoba / Vario TDI | 1.9 | 81 | 03.97 - | AFN | 4 | ▣ | Y-732J | 5605 | | D-POWER 4 | 5605 |
| Cordoba 12V | 1.2 | 47 | 05.05 - 06.06 | BME | 3 | 0,9 | ZFR5P-G | 6893 | | LPG 6 | 1565 |
| Exeo | 1.6 | 75 | 03.09 - | ALZ | 4 | | BKUR6ET-10 | 2397 | 24 | LPG 1 | 1496 |
| Exeo | 1.8 | 110 | 12.08 - | CFMA | 4 | | BKUR6ET-10 | 2397 | 24 | LPG 1 | 1496 |
| Exeo TDI | 2.0 | 105 | 12.08 - | CAGA | 4 | ▣ | Y-609AS | 5849 | | D-POWER 49 | 5849 |
| Exeo TDI | 2.0 | 125 | 02.09 - | CAHA | 4 | ▣ | Y-609AS | 5849 | | D-POWER 49 | 5849 |
| Fura | 0.9 | 29 | 01.82 - 12.84 | 100GL | 4 | 0,8 | BPR6ES | 7822 | 2 | LPG 2 | 1497 |
| Fura Crono | 1.4 | 55 | | | 4 | 0,7 | BP6ES | 7811 | 4 | LPG 2 | 1497 |
| Ibiza | 0.9 | 29 | 06.84 - 09.93 | 100GL | 4 | 0,8 | BPR6ES | 7822 | 2 | LPG 2 | 1497 |
| Ibiza | 1.0 | 33 | 03.93 - | AAU | 4 | | BP5ET | 2287 | | | |
| Ibiza | 1.0 | 37 | 09.96 - | AER | 4 | | BUR6ET | 3172 | 1 | LPG 2 | 1497 |
| Ibiza | 1.0 | 37 | 08.99 - 05.02 | ALD | 4 | 1,1 | PZFR5D-11 | 7968 | 34 | LPG 6 | 1565 |
| Ibiza | 1.0 | 37 | 08.99 - 07.00 | ANV | 4 | 1,1 | PZFR5D-11 | 7968 | 34 | LPG 6 | 1565 |
| Ibiza | 1.0 | 37 | 07.00 - 05.02 | AUC | 4 | 1,1 | PZFR5D-11 | 7968 | 34 | LPG 6 | 1565 |
| Ibiza | 1.2 | 44 | 07.09 - | CGPB | 4 | 1,1 | ZFR6T-11G | 5960 | | ZFR6T-11G | 5960 |
| Ibiza | 1.2 | 47 | 01.02 - | AZQ | 3 | 0,9 | ZFR5P-G | 6893 | | LPG 6 | 1565 |
| Ibiza | 1.2 | 51 | 05.06 - | BXV | 4 | 0,9 | ZFR5P-G | 6893 | | LPG 6 | 1565 |
| Ibiza | 1.3 | 40 | 02.93 - 08.94 | 2G | 4 | | BP6ET | 1263 | | LPG 2 | 1497 |
| Ibiza | 1.3 | 40 | 02.93 - 08.94 | AAV | 4 | | BP5ET | 2287 | | | |
| Ibiza | 1.4 | 44 | 09.93 - 12.95 | ABD | 4 | | BP5ET | 2287 | | | |
| Ibiza | 1.4 | 44 | 09.95 - 12.97 | AEX | 4 | | BUR6ET | 3172 | 1 | LPG 2 | 1497 |
| Ibiza | 1.4 | 44 | 08.99 - 05.02 | AKK | 4 | 1,1 | PZFR5D-11 | 7968 | 34 | LPG 6 | 1565 |
| Ibiza | 1.4 | 44 | 09.97 - | AKV | 4 | | BUR6ET | 3172 | 1 | LPG 2 | 1497 |
| Ibiza | 1.4 | 44 | 05.99 - 08.00 | ANW | 4 | 1,1 | PZFR5D-11 | 7968 | 34 | LPG 6 | 1565 |
| Ibiza | 1.4 | 44 | 12.97 - 05.98 | APQ | 4 | | BUR6ET | 3172 | 1 | LPG 2 | 1497 |
| Ibiza | 1.4 | 44 | 06.00 - 05.02 | AUD | 4 | 1,1 | PZFR5D-11 | 7968 | 34 | LPG 6 | 1565 |
| Ibiza | 1.4 | 55 | 05.98 - | AHW | 4 | | BKUR6ET-10 | 2397 | 24 | LPG 1 | 1496 |
| Ibiza | 1.4 | 63 | 05.06 - | BXW | 4 | 1,1 | ZFR6T-11G | 5960 | | ZFR6T-11G | 5960 |
| Ibiza | 1.6 | 55 | 09.94 - 09.97 | 1F | 4 | | BUR5ET | 3377 | 22 | LPG 2 | 1497 |
| Ibiza | 1.6 | 55 | 02.93 - 07.94 | ABU | 4 | | BUR6ET | 3172 | 1 | LPG 2 | 1497 |
| Ibiza | 1.6 | 55 | 05.97 - 12.98 | AEE | 4 | | BUR6ET | 3172 | 1 | LPG 2 | 1497 |
| Ibiza | 1.6 | 55 | 09.97 - 05.02 | ALM | 4 | | BUR6ET | 3172 | 1 | LPG 2 | 1497 |
| Ibiza | 1.6 | 74 | 05.99 - 05.02 | AEH | 4 | | BKUR6ET-10 | 2397 | 24 | LPG 1 | 1496 |
| Ibiza | 1.6 | 74 | 01.96 - | AEK | 4 | | BKUR5ET | 2789 | 29 | LPG 1 | 1496 |



ℓ kW

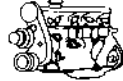

Cyl.

Order-
No.VLINE
No.LPG/CNG
D-PowerOrder-
No.**SEAT**

| | | | | | | | | | | | |
|------------------------------|-----|-----|-------------|---------------|---|-----|------------|------|----|------------|------|
| Ibiza | 1.6 | 74 | 09.95-05.98 | AFT | 4 | | BKUR6ET-10 | 2397 | 24 | LPG 1 | 1496 |
| Ibiza | 1.6 | 74 | 06.99-05.02 | AKL | 4 | | BKUR6ET-10 | 2397 | 24 | LPG 1 | 1496 |
| Ibiza | 1.6 | 74 | 03.00- | APF | 4 | | BKUR6ET-10 | 2397 | 24 | LPG 1 | 1496 |
| Ibiza | 1.6 | 74 | 05.00-05.02 | AUR | 4 | | BKUR6ET-10 | 2397 | 24 | LPG 1 | 1496 |
| Ibiza | 1.6 | 74 | 01.07- | BAH | 4 | 1,1 | PZFR5D-11 | 7968 | 34 | LPG 6 | 1565 |
| Ibiza | 1.6 | 77 | 11.06- | BTS | 4 | 1,1 | ZFR6T-11G | 5960 | | ZFR6T-11G | 5960 |
| Ibiza | 1.7 | 72 | 02.92-09.93 | 021C3000 Cat. | 4 | 0,9 | BCP7ES | 5030 | | BCPR7EIX | 5690 |
| Ibiza | 1.8 | 55 | 08.91- | AAM | 4 | | BUR5ET | 3377 | 22 | LPG 2 | 1497 |
| Ibiza | 1.8 | 66 | 02.93-08.94 | ABS | 4 | | BUR6ET | 3172 | 1 | LPG 2 | 1497 |
| Ibiza | 1.8 | 66 | 03.95-06.99 | ACC | 4 | | BUR6ET | 3172 | 1 | LPG 2 | 1497 |
| Ibiza | 1.8 | 66 | 07.94- | ADZ | 4 | | BUR6ET | 3172 | 1 | LPG 2 | 1497 |
| Ibiza | 1.8 | 95 | 02.94-06.96 | ADL | 4 | | BKUR7ET | 7873 | | PFR7Q | 7963 |
| Ibiza | 2.0 | 85 | 02.93-06.96 | 2E | 4 | | BUR6ET | 3172 | 1 | LPG 2 | 1497 |
| Ibiza | 2.0 | 85 | 04.96- | AGG | 4 | | BUR6ET | 3172 | 1 | LPG 2 | 1497 |
| Ibiza | 2.0 | 85 | 07.02-04.04 | AZL | 4 | | BKUR6ET-10 | 2397 | 24 | LPG 1 | 1496 |
| Ibiza | 2.0 | 85 | 04.03- | BBX | 4 | | BKUR6ET-10 | 2397 | 24 | LPG 1 | 1496 |
| Ibiza 16V | 1.8 | 100 | | | 4 | | BUR6ET | 3172 | 1 | LPG 2 | 1497 |
| Ibiza 20V | 1.8 | 110 | 12.03- | BJX | 4 | 0,8 | PFR6Q | 6458 | 37 | LPG 1 | 1496 |
| Ibiza 20V | 1.8 | 110 | 12.03- | BKV | 4 | 0,8 | PFR6Q | 6458 | 37 | LPG 1 | 1496 |
| Ibiza 20V Turbo | 1.8 | 115 | 12.99- | AQX | 5 | | BKUR6ET-10 | 2397 | 24 | LPG 1 | 1496 |
| Ibiza 20V Turbo | 1.8 | 115 | 05.00-05.02 | AYP | 5 | | BKUR6ET-10 | 2397 | 24 | LPG 1 | 1496 |
| Ibiza FSI | 1.4 | 110 | 06.09- | CAVF | 4 | 0,9 | PZFR6R | 5758 | | PZFR6R | 5758 |
| Ibiza SDI | 1.9 | 47 | 07.96- | AEY | 4 | | Y-732J | 5605 | | D-POWER 4 | 5605 |
| Ibiza SDI | 1.9 | 47 | 05.05-12.05 | ASY | 4 | | Y-732J | 5605 | | D-POWER 4 | 5605 |
| Ibiza SDI | 1.9 | 50 | 04.99-05.02 | AGP | 4 | | Y-732J | 5605 | | D-POWER 4 | 5605 |
| Ibiza SDI | 1.9 | 50 | 05.99-05.02 | AQM | 4 | | Y-732J | 5605 | | D-POWER 4 | 5605 |
| Ibiza TD | 1.9 | 55 | 02.93-08.97 | AAZ | 4 | | Y-918J | 6285 | | D-POWER 2 | 6285 |
| Ibiza TDI | 1.4 | 51 | 05.05- | BNM | 3 | | Y-741U | 6943 | | D-POWER 20 | 6943 |
| Ibiza TDI | 1.4 | 58 | 05.05- | BNV | 3 | | Y-741U | 6943 | | D-POWER 20 | 6943 |
| Ibiza TDI | 1.4 | 59 | 06.06- | BMS | 3 | | CZ104 | 9826 | | D-POWER 52 | 9826 |
| Ibiza TDI | 1.6 | 55 | 05.10- | CAYA | 4 | | Y-609AS | 5849 | | D-POWER 49 | 5849 |
| Ibiza TDI | 1.6 | 66 | 05.09- | CAYB | 4 | | Y-609AS | 5849 | | D-POWER 49 | 5849 |
| Ibiza TDI | 1.9 | 66 | 07.96-12.96 | 1Z | 4 | | Y-732J | 5605 | | D-POWER 4 | 5605 |
| Ibiza TDI | 1.9 | 66 | 04.99-05.02 | AGR | 4 | | Y-732J | 5605 | | D-POWER 4 | 5605 |
| Ibiza TDI | 1.9 | 66 | 12.96- | AHU | 4 | | Y-732J | 5605 | | D-POWER 4 | 5605 |
| Ibiza TDI | 1.9 | 66 | 06.08- | BXJ | 4 | | Y-607AS | 7560 | | D-POWER 50 | 7560 |
| Ibiza TDI | 1.9 | 66 | 05.99-05.02 | ALH | 4 | | Y-732J | 5605 | | D-POWER 4 | 5605 |
| Ibiza TDI | 1.9 | 74 | 05.05- | AXR | 4 | | Y-741U | 6943 | | D-POWER 20 | 6943 |
| Ibiza TDI | 1.9 | 74 | 09.06- | BMT | 4 | | CZ104 | 9826 | | D-POWER 52 | 9826 |
| Ibiza TDI | 1.9 | 77 | 02.08- | BLS | 4 | | Y-607AS | 7560 | | D-POWER 50 | 7560 |
| Ibiza TDI | 1.9 | 81 | 03.97- | AFN | 4 | | Y-732J | 5605 | | D-POWER 4 | 5605 |
| Ibiza TDI | 1.9 | 81 | 03.99-05.02 | ASV | 4 | | Y-732J | 5605 | | D-POWER 4 | 5605 |
| Ibiza TDI | 1.9 | 96 | 05.05- | BLT | 4 | | Y-741U | 6943 | | D-POWER 20 | 6943 |
| Ibiza TDI | 1.9 | 118 | 11.05- | BUK | 4 | | Y-741U | 6943 | | D-POWER 20 | 6943 |
| Ibiza TDI Fgst 6L-2-001 501> | 1.4 | 55 | 05.05-12.05 | AMF | 3 | | Y-741U | 6943 | | D-POWER 20 | 6943 |
| Ibiza TDI Fgst 6L-2-001 501> | 1.9 | 74 | 05.05-05.05 | ATD | 4 | | Y-741U | 6943 | | D-POWER 20 | 6943 |
| Ibiza TDI Fgst 6L-2-001 501> | 1.9 | 96 | 05.05-09.05 | ASZ | 4 | | Y-741U | 6943 | | D-POWER 20 | 6943 |
| Ibiza TFSI Cupra | 1.4 | 132 | 05.09- | CAVE | 4 | 0,9 | PZFR6R | 5758 | | PZFR6R | 5758 |
| Ibiza 12v | 1.2 | 47 | 05.05-06.06 | BME | 3 | 0,9 | ZFR5P-G | 6893 | | LPG 6 | 1565 |
| Ibiza 12V | 1.2 | 52 | 03.08- | BZG | 3 | 0,9 | ZFR5P-G | 6893 | | LPG 6 | 1565 |
| Ibiza 16V | 1.0 | 51 | 06.00-05.02 | AST | 4 | | BKUR5ET-10 | 7553 | | LPG 1 | 1496 |
| Ibiza 16V | 1.0 | 51 | 05.00-05.02 | AVZ | 4 | | BKUR5ET-10 | 7553 | | LPG 1 | 1496 |

Fgst = Chassis No.



ℓ kW



Cyl.

Order-
No. No.LPG/CNG
D-PowerOrder-
No.**SEAT**

| | | | | | | | | | | | |
|-----------------------|-----|-----|---------------|-----------------|---|-----|------------|------|----|------------|------|
| Ibiza 16V | 1.4 | 55 | 09.99 - 06.00 | APE | 4 | | BKUR6ET-10 | 2397 | 24 | LPG 1 | 1496 |
| Ibiza 16V | 1.4 | 55 | 06.00 - 05.02 | AUA | 4 | | BKUR6ET-10 | 2397 | 24 | LPG 1 | 1496 |
| Ibiza 16V | 1.4 | 55 | 01.02 - 04.04 | BBY | 4 | | BKUR6ET-10 | 2397 | 24 | LPG 1 | 1496 |
| Ibiza 16V | 1.4 | 55 | 05.04 - 06.06 | BKY | 4 | | BKUR6ET-10 | 2397 | 24 | LPG 1 | 1496 |
| Ibiza 16V | 1.4 | 74 | 06.97 - | AFH | 4 | | BKUR6ET | 6437 | 27 | LPG 1 | 1496 |
| Ibiza 16V | 1.4 | 74 | 09.99 - 07.00 | AQQ | 4 | | BKUR6ET-10 | 2397 | 24 | LPG 1 | 1496 |
| Ibiza 16V | 1.4 | 74 | 07.00 - 05.02 | AUB | 4 | | BKUR6ET-10 | 2397 | 24 | LPG 1 | 1496 |
| Ibiza 16V | 1.4 | 74 | 04.02 - | BBZ | 4 | | BKUR6ET-10 | 2397 | 24 | LPG 1 | 1496 |
| Ibiza 16V Automatic | 1.4 | 55 | 01.02 - 04.04 | BBY | 4 | 1,1 | PZFR5D-11 | 7968 | 34 | LPG 6 | 1565 |
| Ibiza 16V Automatic | 1.4 | 55 | 05.04 - 06.06 | BKY | 4 | 1,1 | PZFR5D-11 | 7968 | 34 | LPG 6 | 1565 |
| Ibiza Cupra | 2.0 | 110 | 07.96 - | ABF | 4 | | BKUR6ET-10 | 2397 | 24 | LPG 1 | 1496 |
| Ibiza Cupra TDI | 1.9 | 118 | 03.04 - | BPX | 4 | █ | Y-741U | 6943 | | D-POWER 20 | 6943 |
| Ibiza Cupra 20V | 1.8 | 132 | 05.04 - | BBU | 4 | 0,8 | PFR6Q | 6458 | 37 | LPG 1 | 1496 |
| Ibiza Cupra 20V | 1.8 | 132 | 05.04 - | BLZ | 4 | 0,8 | PFR6Q | 6458 | 37 | LPG 1 | 1496 |
| Ibiza D | 1.7 | 40 | 06.84 - 08.87 | | 4 | █ | Y-208T | 1250 | | | |
| Ibiza D | 1.7 | | 09.87 - | | 4 | █ | Y-902R | 2237 | | | |
| Ibiza D | 1.9 | 47 | 02.93 - | 1Y | 4 | █ | Y-918J | 6285 | | D-POWER 2 | 6285 |
| Ibiza MPI | 1.2 | 44 | 06.07 - | BBM | 4 | 0,9 | ZFR5P-G | 6893 | | LPG 6 | 1565 |
| Ibiza/Malaga 1,2 | 1.2 | 46 | 06.84 - 08.89 | 021-A-1000 | 4 | 0,9 | BCP7ES | 5030 | | BCPR7EIX | 5690 |
| Ibiza/Malaga 1,2i | 1.2 | 52 | 08.89 - 03.93 | 021-C-1000 Cat. | 4 | 0,9 | BCP7ES | 5030 | | BCPR7EIX | 5690 |
| Ibiza/Malaga 1,5 | 1.5 | 65 | 04.89 - 08.91 | 021-D-2000 | 4 | 0,9 | BCP7ES | 5030 | | BCPR7EIX | 5690 |
| Ibiza/Malaga 1,5i | 1.5 | 66 | 09.87 - 09.93 | 021-C-2000 Cat. | 4 | 0,9 | BCP7ES | 5030 | | BCPR7EIX | 5690 |
| Ibiza/Malaga 1,5i SXi | 1.5 | 74 | 06.88 - 08.91 | 021-B-2000 | 4 | 0,9 | BCP7ES | 5030 | | BCPR7EIX | 5690 |
| Inca | 1.4 | 44 | 11.95 - 12.97 | AEX | 4 | | BUR6ET | 3172 | 1 | LPG 2 | 1497 |
| Inca | 1.4 | 44 | 12.97 - 09.00 | AKV | 4 | | BUR6ET | 3172 | 1 | LPG 2 | 1497 |
| Inca | 1.4 | 44 | 12.97 - 06.03 | APQ | 4 | | BUR6ET | 3172 | 1 | LPG 2 | 1497 |
| Inca | 1.4 | 44 | 09.00 - 06.03 | AUD | 4 | 1,1 | PZFR5D-11 | 7968 | 34 | LPG 6 | 1565 |
| Inca | 1.6 | 55 | 11.95 - 05.97 | 1F | 4 | | BUR5ET | 3377 | 22 | LPG 2 | 1497 |
| Inca | 1.6 | 55 | 06.97 - 09.00 | AEE | 4 | | BUR6ET | 3172 | 1 | LPG 2 | 1497 |
| Inca 16V | 1.4 | 55 | 09.00 - 06.03 | AUA | 4 | | BKUR6ET-10 | 2397 | 24 | LPG 1 | 1496 |
| Inca D | 1.7 | 42 | 07.96 - 09.00 | AHB | 4 | █ | Y-918J | 6285 | | D-POWER 2 | 6285 |
| Inca D | 1.9 | 47 | 11.95 - 06.03 | 1Y | 4 | █ | Y-918J | 6285 | | D-POWER 2 | 6285 |
| Inca SDI | 1.9 | 47 | 11.95 - 09.00 | AEY | 4 | █ | Y-732J | 5605 | | D-POWER 4 | 5605 |
| Inca SDI | 1.9 | 47 | 09.00 - 06.03 | AYQ | 4 | █ | Y-732J | 5605 | | D-POWER 4 | 5605 |
| León | 1.4 | 55 | 01.00 - 05.02 | AHW | 4 | | BKUR6ET-10 | 2397 | 24 | LPG 1 | 1496 |
| León | 1.4 | 55 | 00 - | AKQ | 4 | | BKUR6ET-10 | 2397 | 24 | LPG 1 | 1496 |
| León | 1.4 | 55 | 11.99 - 05.00 | APE | 4 | | BKUR6ET-10 | 2397 | 24 | LPG 1 | 1496 |
| León | 1.4 | 63 | 06.06 - | BXW | 4 | 1,1 | ZFR6T-11G | 5960 | | ZFR6T-11G | 5960 |
| León | 1.6 | 74 | 11.98 - 10.05 | AEH | 4 | | BKUR6ET-10 | 2397 | 24 | LPG 1 | 1496 |
| León | 1.6 | 74 | 10.98 - 10.05 | AKL | 4 | | BKUR6ET-10 | 2397 | 24 | LPG 1 | 1496 |
| León | 1.6 | 75 | 10.05 - | BFQ | 4 | | BKUR6ET-10 | 2397 | 24 | LPG 1 | 1496 |
| León | 1.6 | 75 | 07.05 - | BSE | 4 | | BKUR6ET-10 | 2397 | 24 | LPG 1 | 1496 |
| León | 1.6 | 75 | 07.05 - | BSF | 4 | | BKUR6ET-10 | 2397 | 24 | LPG 1 | 1496 |
| León | 1.6 | 75 | 10.09 - | CCSA | 4 | | BKUR6ET-10 | 2397 | 24 | LPG 1 | 1496 |
| León | 1.6 | 77 | 11.99 - | ATN | 4 | | BKUR6ET-10 | 2397 | 24 | LPG 1 | 1496 |
| León 16V | 1.4 | 55 | 06.00 - 02.02 | AXP | 4 | | BKUR6ET-10 | 2397 | 24 | LPG 1 | 1496 |
| León 16V | 1.4 | 55 | 02.02 - 10.05 | BCA | 4 | | BKUR6ET-10 | 2397 | 24 | LPG 1 | 1496 |
| León 16V | 1.6 | 77 | 06.00 - 04.01 | AUS | 4 | | BKUR6ET-10 | 2397 | 24 | LPG 1 | 1496 |
| León 16V | 1.6 | 77 | 05.01 - 04.02 | AZD | 4 | 1,1 | PZFR6J-11 | 3586 | | LPG 6 | 1565 |
| León 16V | 1.6 | 77 | 04.02 - 06.06 | BCB | 4 | 1,1 | PZFR6J-11 | 3586 | | LPG 6 | 1565 |
| León 16V | 2.3 | 125 | 05.01 - 11.03 | AQN | 5 | 1,1 | PZFR5D-11 | 7968 | 34 | LPG 6 | 1565 |
| León 20V | 1.8 | 92 | 10.98 - 12.03 | AGN | 4 | | BKUR6ET-10 | 2397 | 24 | LPG 1 | 1496 |



ℓ kW

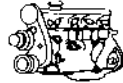

Cyl.

Order-
No.VLINE
No.LPG/CNG
D-PowerOrder-
No.**SEAT**

| | | | | | | | | | | | |
|-----------------------------|-----|-----|---------------|-------------|---|-----|------------|------|----|------------|------|
| León 20V | 1.8 | 132 | 04.00 - | AJQ | 4 | 0,8 | PFR6Q | 6458 | 37 | LPG 1 | 1496 |
| León 20V | 1.8 | 132 | 06.00 - 10.05 | APG | 4 | | BKUR6ET-10 | 2397 | 24 | LPG 1 | 1496 |
| León 20V | 1.8 | 132 | 09.00 - 04.04 | ARY | 4 | 0,8 | PFR6Q | 6458 | 37 | LPG 1 | 1496 |
| León 20V | 1.8 | 132 | 05.01 - 10.05 | AUQ | 4 | 0,8 | PFR6Q | 6458 | 37 | LPG 1 | 1496 |
| León 20V | 1.8 | 132 | 09.00 - 10.05 | AUQ | 4 | 0,8 | PFR6Q | 6458 | 37 | LPG 1 | 1496 |
| León 24V | 2.8 | 150 | 05.01 - 07.01 | AUE | 6 | 1,1 | PZFR5D-11 | 7968 | 34 | LPG 6 | 1565 |
| León 24V | 2.8 | 150 | 06.01 - 04.04 | BDE | 6 | 1,1 | PZFR5D-11 | 7968 | 34 | LPG 6 | 1565 |
| León FSI | 2.0 | 110 | 07.05 - 11.05 | BLR | 4 | | PZFR5N-11T | 7742 | | PZFR5N-11T | 7742 |
| León FSI | 2.0 | 110 | 07.05 - 11.05 | BLY | 4 | | PZFR5N-11T | 7742 | | PZFR5N-11T | 7742 |
| León FSI | 2.0 | 110 | 11.05 - 03.09 | BVY | 4 | | PZFR5N-11T | 7742 | | PZFR5N-11T | 7742 |
| León FSI | 2.0 | 110 | 11.05 - | BVZ | 4 | | PZFR5N-11T | 7742 | | PZFR5N-11T | 7742 |
| León SDI | 1.9 | 50 | 03.00 - 10.03 | AQM | 4 | █ | Y-732J | 5605 | | D-POWER 4 | 5605 |
| León TD | 1.9 | 66 | 04.99 - 09.02 | AGR | 4 | █ | Y-732J | 5605 | | D-POWER 4 | 5605 |
| León TDI | 1.9 | 66 | 03.99 - 10.05 | ALH | 4 | █ | Y-732J | 5605 | | D-POWER 4 | 5605 |
| León TDI | 1.9 | 66 | 06.07 - | BXF | 4 | █ | Y-607AS | 7560 | | D-POWER 50 | 7560 |
| León TDI | 1.9 | 77 | 07.05 - 02.06 | BKC | 4 | █ | Y-607AS | 7560 | | D-POWER 50 | 7560 |
| León TDI | 1.9 | 77 | 11.05 - | BLS | 4 | █ | CZ104 | 9826 | | D-POWER 52 | 9826 |
| León TDI | 1.9 | 77 | 02.06 - | BXE | 4 | █ | Y-607AS | 7560 | | D-POWER 50 | 7560 |
| León TDI | 1.9 | 81 | 10.98 - 09.02 | AHF | 4 | █ | Y-732J | 5605 | | D-POWER 4 | 5605 |
| León TDI | 1.9 | 81 | 11.99 - 10.05 | ASV | 4 | █ | Y-732J | 5605 | | D-POWER 4 | 5605 |
| León TDI | 1.9 | 96 | 05.03 - 06.06 | ASZ | 4 | █ | Y-741U | 6943 | | D-POWER 20 | 6943 |
| León TDI Fgst >1M-2-062000 | 1.9 | 110 | 09.00 - | ARL | 4 | █ | Y-732J | 5605 | | D-POWER 4 | 5605 |
| León TDI Fgst 1M-2-062001 > | 1.9 | 110 | 09.00 - 12.05 | ARL | 4 | █ | Y-741U | 6943 | | D-POWER 20 | 6943 |
| León TDI | 2.0 | 100 | 07.05 - 03.09 | AZV | 4 | █ | YE14 | 7768 | | D-POWER 48 | 7768 |
| León TDI | 2.0 | 103 | 07.05 - | BKD | 4 | █ | YE14 | 7768 | | D-POWER 48 | 7768 |
| León TDI | 2.0 | 103 | 10.05 - | BMM | 4 | █ | Y-607AS | 7560 | | D-POWER 50 | 7560 |
| León TDI | 2.0 | 125 | 05.06 - 03.09 | BMN | 4 | █ | CZ304 | 9864 | | D-POWER 55 | 9864 |
| León TDI | 2.0 | 125 | 03.09 - 09.10 | CEGA | 4 | █ | Y-609AS | 5849 | | D-POWER 49 | 5849 |
| León TFSI | 1.4 | 92 | 11.07 - | CAXC | 4 | | PZFR6R | 5758 | | PZFR6R | 5758 |
| León TFSI | 1.8 | 118 | 05.07 - 03.09 | BZB | 4 | | PFR7S8EG | 1675 | | | |
| León TFSI | 1.8 | 118 | 03.09 - | CDAA | 4 | | PFR7S8EG | 1675 | | | |
| León TFSI | 2.0 | 136 | 10.05 - 05.06 | BWA1 | 4 | | PFR7S8EG | 1675 | | | |
| León TFSI | 2.0 | 147 | 05.05 - 03.09 | BWA | 4 | | PFR7S8EG | 1675 | | | |
| León TFSI | 2.0 | 177 | 11.06 - 05.09 | BWJ | 4 | | PFR7S8EG | 1675 | | | |
| León Cupra | 1.8 | 154 | 05.02 - 05.03 | AMK | 4 | 0,8 | PFR6Q | 6458 | 37 | LPG 1 | 1496 |
| León Cupra | 1.8 | 165 | 05.03 - | BAM | 4 | 0,8 | PFR6Q | 6458 | 37 | LPG 1 | 1496 |
| León turbo | 1.8 | 132 | 11.99 - | APP | 4 | 0,8 | PFR6Q | 6458 | 37 | LPG 1 | 1496 |
| Malaga D | 1.7 | 40 | 05.85 - 08.87 | | 4 | █ | Y-208T | 1250 | | | |
| Malaga D | 1.7 | | 09.87 - 08.91 | | 4 | █ | Y-902R | 2237 | | | |
| Marbella 0,8 | 0.9 | 25 | 01.87 - 12.91 | 903 08NCA | 4 | 0,8 | BPR6ES | 7822 | 2 | LPG 2 | 1497 |
| Marbella 0,9 | 0.9 | 29 | 86 - 12.92 | 09NCA Verg. | 4 | 0,8 | BPR6ES | 7822 | 2 | LPG 2 | 1497 |
| Marbella 0,9 | 0.9 | 30 | 92 - 05.98 | 09NCB Cat. | 4 | 0,9 | BPR5ES | 7422 | 6 | LPG 2 | 1497 |
| Panda 35 | 0.8 | 26 | | | 4 | 0,7 | BP6ES | 7811 | 4 | LPG 2 | 1497 |
| Panda 45 | 0.9 | 33 | | | 4 | 0,7 | BP6ES | 7811 | 4 | LPG 2 | 1497 |
| Ritmo D | 1.7 | 40 | 09.80 - 08.88 | | 4 | █ | Y-208T | 1250 | | | |
| Ronda 1,2 | 1.2 | 44 | 05.84 - 08.91 | 021.1000 | 4 | 0,9 | BCP7ES | 5030 | | BCPR7EIX | 5690 |
| Ronda 1,2 | 1.2 | 47 | 05.84 - 08.91 | 124B.6000 | 4 | 0,8 | BPR6ES | 7822 | 2 | LPG 2 | 1497 |
| Ronda 1,5 | 1.5 | 63 | 05.84 - 08.91 | 021A.2000 | 4 | 0,9 | BCP7ES | 5030 | | BCPR7EIX | 5690 |
| Ronda 1,6 | 1.6 | 68 | 05.84 - 08.91 | 022A.000 | 4 | 0,8 | BP7ES | 2412 | | BPR8EIX | 6684 |
| Ronda D | 1.7 | 40 | 06.82 - 12.86 | 138 A5 | 4 | █ | Y-208T | 1250 | | | |
| Ronda D | 1.7 | | 09.87 - 08.88 | | 4 | █ | Y-902R | 2237 | | | |
| Terra 0,9 | 0.9 | 29 | 09.87 - 08.91 | 09NCA | 4 | 0,8 | BPR6ES | 7822 | 2 | LPG 2 | 1497 |

Fgst = Chassis No.



ℓ kW



Cyl.

Order-
No. No.LPG/CNG
D-PowerOrder-
No.**SEAT**

| | | | | | | | | | | | | |
|----------------|-----|-----|---------------|-------|------|---|-----|------------|------|----|------------|------|
| Terra 0,9 | 0.9 | 29 | 08.91 - 05.98 | 09NCB | Cat. | 4 | 0,9 | BPR5ES | 7422 | 6 | LPG 2 | 1497 |
| Terra D | 1.4 | 35 | 01.90 - | | | 4 | █ | Y-918J | 6285 | | D-POWER 2 | 6285 |
| Terra D | 1.4 | 35 | 10.90 - | | | 4 | █ | Y-918J | 6285 | | D-POWER 2 | 6285 |
| Terra Kombi D | 1.4 | | 10.91 - | 1W | | 4 | █ | Y-918J | 6285 | | D-POWER 2 | 6285 |
| Toledo | 1.4 | 55 | 01.00 - 05.02 | AHW | | 4 | | BKUR6ET-10 | 2397 | 24 | LPG 1 | 1496 |
| Toledo | 1.4 | 55 | 00 - | AKQ | | 4 | | BKUR6ET-10 | 2397 | 24 | LPG 1 | 1496 |
| Toledo | 1.6 | 52 | 11.93 - 10.99 | ABM | | 4 | | BUR5ET | 3377 | 22 | LPG 2 | 1497 |
| Toledo | 1.6 | 54 | 08.91 - 10.99 | EZ | | 4 | | BUR5ET-10 | 7264 | 21 | LPG 2 | 1497 |
| Toledo | 1.6 | 55 | 11.93 - 03.99 | 1F | | 4 | | BUR5ET | 3377 | 22 | LPG 2 | 1497 |
| Toledo | 1.6 | 55 | 03.93 - | ABU | | 4 | | BUR6ET | 3172 | 1 | LPG 2 | 1497 |
| Toledo | 1.6 | 74 | 11.98 - 10.05 | AEH | | 4 | | BKUR6ET-10 | 2397 | 24 | LPG 1 | 1496 |
| Toledo | 1.6 | 74 | 01.96 - 03 | AEK | | 4 | | BKUR5ET | 2789 | 29 | LPG 1 | 1496 |
| Toledo | 1.6 | 74 | 04.96 - 03.99 | AFT | | 4 | | BKUR6ET-10 | 2397 | 24 | LPG 1 | 1496 |
| Toledo | 1.6 | 74 | 02.99 - 10.05 | AKL | | 4 | | BKUR6ET-10 | 2397 | 24 | LPG 1 | 1496 |
| Toledo | 1.6 | 74 | 09.99 - | APF | | 4 | | BKUR6ET-10 | 2397 | 24 | LPG 1 | 1496 |
| Toledo | 1.6 | 75 | 10.05 - | BFQ | | 4 | | BKUR6ET-10 | 2397 | 24 | LPG 1 | 1496 |
| Toledo | 1.6 | 75 | 09.04 - 05.05 | BGU | | 4 | | BKUR6ET-10 | 2397 | 24 | LPG 1 | 1496 |
| Toledo | 1.6 | 75 | 05.05 - | BSE | | 4 | | BKUR6ET-10 | 2397 | 24 | LPG 1 | 1496 |
| Toledo | 1.6 | 75 | 05.05 - 05.07 | BSF | | 4 | | BKUR6ET-10 | 2397 | 24 | LPG 1 | 1496 |
| Toledo | 1.6 | 75 | 12.07 - | CCSA | | 4 | | BKUR6ET-10 | 2397 | 24 | LPG 1 | 1496 |
| Toledo | 1.6 | 77 | 11.99 - | ATN | | 4 | | BKUR6ET-10 | 2397 | 24 | LPG 1 | 1496 |
| Toledo | 1.6 | 77 | 04.02 - 05.06 | BCB | | 4 | 1,1 | PZFR6J-11 | 3586 | | LPG 6 | 1565 |
| Toledo | 1.8 | 66 | 05.91 - 07.94 | ABS | | 4 | | BUR6ET | 3172 | 1 | LPG 2 | 1497 |
| Toledo | 1.8 | 66 | 01.95 - | ACC | | 4 | | BUR6ET | 3172 | 1 | LPG 2 | 1497 |
| Toledo | 1.8 | 66 | 11.94 - 05.99 | ADZ | | 4 | | BUR6ET | 3172 | 1 | LPG 2 | 1497 |
| Toledo | 1.8 | 66 | 08.91 - 12.92 | RP | | 4 | | BUR6ET | 3172 | 1 | LPG 2 | 1497 |
| Toledo | 1.8 | 92 | 09.00 - 10.05 | APG | | 4 | | BKUR6ET-10 | 2397 | 24 | LPG 1 | 1496 |
| Toledo | 1.8 | 132 | 03.00 - 01.01 | AJQ | | 4 | 0,8 | PFR6Q | 6458 | 37 | LPG 1 | 1496 |
| Toledo | 1.8 | 132 | 05.01 - 04.04 | ARY | | 4 | 0,8 | PFR6Q | 6458 | 37 | LPG 1 | 1496 |
| Toledo | 1.8 | 132 | 05.01 - 10.05 | AUQ | | 4 | 0,8 | PFR6Q | 6458 | 37 | LPG 1 | 1496 |
| Toledo | 2.0 | 85 | 05.91 - | 2E | | 4 | | BUR6ET | 3172 | 1 | LPG 2 | 1497 |
| Toledo | 2.0 | 85 | 06.99 - | AQY | | 4 | | BKUR6ET-10 | 2397 | 24 | LPG 1 | 1496 |
| Toledo | 2.0 | 100 | | 9A | | 4 | | BKUR7ET | 7873 | | PFR7Q | 7963 |
| Toledo | 2.0 | 110 | 05.94 - 03.99 | ABF | | 4 | | BKUR6ET-10 | 2397 | 24 | LPG 1 | 1496 |
| Toledo | 2.3 | 125 | 09.00 - 11.03 | AQN | | 5 | 1,1 | PZFR5D-11 | 7968 | 34 | LPG 6 | 1565 |
| Toledo | 2.8 | 150 | 05.01 - | AUE | | 6 | 1,1 | PZFR5D-11 | 7968 | 34 | LPG 6 | 1565 |
| Toledo | 2.8 | 150 | 05.02 - 04.04 | BDE | | 6 | 1,1 | PZFR5D-11 | 7968 | 34 | LPG 6 | 1565 |
| Toledo 16V | 1.6 | 77 | 06.00 - | AUS | | 4 | | BKUR6ET-10 | 2397 | 24 | LPG 1 | 1496 |
| Toledo 16V | 1.6 | 77 | 09.00 - 04.02 | AZD | | 4 | | BKUR6ET-10 | 2397 | 24 | LPG 1 | 1496 |
| Toledo 16V | 1.8 | 92 | 08.91 - 05.94 | PL | | 4 | | BKUR7ET | 7873 | | PFR7Q | 7963 |
| Toledo 16V | 1.8 | 98 | 08.91 - | KR | | 4 | | BCPR7ET | 2164 | | BCPR7EIX | 5690 |
| Toledo 20V | 1.8 | 92 | 10.98 - 12.03 | AGN | | 4 | | BKUR6ET-10 | 2397 | 24 | LPG 1 | 1496 |
| Toledo D | 1.9 | 47 | 03.91 - 03.99 | 1Y | | 4 | █ | Y-918J | 6285 | | D-POWER 2 | 6285 |
| Toledo FSI | 1.4 | 92 | 11.07 - 05.09 | CAXC | | 4 | | PZFR6R | 5758 | | PZFR6R | 5758 |
| Toledo FSI | 1.8 | 118 | 01.07 - 06.07 | BYT | | 4 | | PFR7S8EG | 1675 | | | |
| Toledo FSI | 1.8 | 118 | 06.07 - 03.09 | BZB | | 4 | | PFR7S8EG | 1675 | | | |
| Toledo FSI 16V | 2.0 | 110 | 09.04 - 11.05 | BLR | | 4 | | PZFR5N-11T | 7742 | | PZFR5N-11T | 7742 |
| Toledo FSI 16V | 2.0 | 110 | 11.04 - 11.05 | BLY | | 4 | | BKR6E | 6962 | 28 | LPG 1 | 1496 |
| Toledo FSI 16V | 2.0 | 110 | 11.05 - 03.09 | BVY | | 4 | | PZFR5N-11T | 7742 | | PZFR5N-11T | 7742 |
| Toledo FSI 16V | 2.0 | 110 | 11.05 - 03.09 | BVZ | | 4 | | BKR6E | 6962 | 28 | LPG 1 | 1496 |
| Toledo SDI | 1.9 | 50 | 05.01 - 10.03 | AQM | | 4 | █ | Y-732J | 5605 | | D-POWER 4 | 5605 |
| Toledo TD | 1.9 | 55 | 03.91 - 04.97 | AAZ | | 4 | █ | Y-918J | 6285 | | D-POWER 2 | 6285 |



ℓ kW

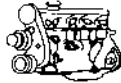

Cyl.

Order-
No.LPG/CNG
D-PowerOrder-
No.**SEAT**

| | | | | | | | | | | | |
|--------------------|-----|-----|---------------|------|---|-----|------------|------|----|------------|------|
| Toledo TDI | 1.9 | 66 | 08.93 - 12.96 | 1Z | 4 | █ | Y-732J | 5605 | | D-POWER 4 | 5605 |
| Toledo TDI | 1.9 | 66 | 05.99 - 09.02 | AGR | 4 | █ | Y-732J | 5605 | | D-POWER 4 | 5605 |
| Toledo TDI | 1.9 | 66 | 03.99 - 10.05 | ALH | 4 | █ | Y-732J | 5605 | | D-POWER 4 | 5605 |
| Toledo TDI | 1.9 | 77 | 09.04 - 09.05 | BJB | 4 | █ | Y-607AS | 7560 | | D-POWER 50 | 7560 |
| Toledo TDI | 1.9 | 77 | 09.04 - 02.06 | BKC | 4 | █ | Y-607AS | 7560 | | D-POWER 50 | 7560 |
| Toledo TDI | 1.9 | 77 | 10.05 - 05.09 | BLS | 4 | █ | CZ104 | 9826 | | D-POWER 52 | 9826 |
| Toledo TDI | 1.9 | 77 | 02.06 - 05.09 | BXE | 4 | █ | Y-607AS | 7560 | | D-POWER 50 | 7560 |
| Toledo TDI | 1.9 | 81 | 12.96 - 03.99 | AFN | 4 | █ | Y-732J | 5605 | | D-POWER 4 | 5605 |
| Toledo TDI | 1.9 | 81 | 05.99 - 09.02 | AHF | 4 | █ | Y-732J | 5605 | | D-POWER 4 | 5605 |
| Toledo TDI | 1.9 | 81 | 10.99 - 10.05 | ASV | 4 | █ | Y-732J | 5605 | | D-POWER 4 | 5605 |
| Toledo TDI | 1.9 | 110 | 10.00 - 12.05 | ARL | 4 | █ | Y-732J | 5605 | | D-POWER 4 | 5605 |
| Toledo TDI | 2.0 | 100 | 09.04 - 05.09 | AZV | 4 | █ | YE14 | 7768 | | D-POWER 48 | 7768 |
| Toledo TDI | 2.0 | 103 | 04.04 - 05.09 | BKD | 4 | █ | YE14 | 7768 | | D-POWER 48 | 7768 |
| Toledo TDI | 2.0 | 103 | 11.05 - 05.09 | BMM | 4 | █ | Y-607AS | 7560 | | D-POWER 50 | 7560 |
| Toledo TDI | 2.0 | 125 | 01.06 - 05.09 | BMN | 4 | █ | CZ304 | 9864 | | D-POWER 55 | 9864 |
| Toledo TDI | 2.0 | 125 | 03.09 - 05.09 | CEGA | 4 | █ | Y-609AS | 5849 | | D-POWER 49 | 5849 |
| Toledo TFSI | 1.8 | 118 | 03.09 - 05.09 | CDA | 4 | | PFR7S8EG | 1675 | | | |
| Toledo TFSI | 2.0 | 147 | 11.05 - 05.09 | BWA | 4 | | PFR7S8EG | 1675 | | | |
| Toledo 16V | 1.4 | 55 | 11.99 - | APE | 4 | | BKUR6ET-10 | 2397 | 24 | LPG 1 | 1496 |
| Toledo 16V | 1.4 | 55 | 06.00 - | AXP | 4 | | BKUR6ET-10 | 2397 | 24 | LPG 1 | 1496 |
| Toledo 16V | 1.4 | 55 | 02.02 - 10.05 | BCA | 4 | | BKUR6ET-10 | 2397 | 24 | LPG 1 | 1496 |
| Toledo 2,0i | 2.0 | 85 | 07.95 - 03.99 | AGG | 4 | | BUR6ET | 3172 | 1 | LPG 2 | 1497 |
| Toledo 20V Cupra R | 1.8 | 154 | 05.02 - 05.03 | AMK | 4 | 0,8 | PFR6Q | 6458 | 37 | LPG 1 | 1496 |
| Toledo 20V Cupra R | 1.8 | 165 | 05.03 - | BAM | 4 | 0,8 | PFR6Q | 6458 | 37 | LPG 1 | 1496 |
| Toledo SRE | 1.4 | 63 | 05.06 - 05.09 | BXW | 4 | 1,1 | ZFR6T-11G | 5960 | | ZFR6T-11G | 5960 |
| Toledo turbo | 1.8 | 132 | 11.99 - | APP | 4 | 0,8 | PFR6Q | 6458 | 37 | LPG 1 | 1496 |
| Toledo VR5 | 2.3 | 110 | 10.98 - 11.00 | AGZ | 5 | | BKR5EKUP | 2890 | | | |
| VAN | 1.0 | 33 | - 09.96 | | 4 | | BUR6ET | 3172 | 1 | LPG 2 | 1497 |
| VAN | 1.0 | 37 | 09.96 - | AER | 4 | | BUR6ET | 3172 | 1 | LPG 2 | 1497 |
| VAN | 1.4 | 44 | | | 4 | | BUR6ET | 3172 | 1 | LPG 2 | 1497 |
| VAN | 1.6 | 55 | | | 4 | | BUR5ET | 3377 | 22 | LPG 2 | 1497 |

SKODA

| | | | | | | | | | | | |
|----------------------|-----|----|---------------|--------|---|-----|------------|------|----|---------|------|
| 135 / 136 | 1.3 | 46 | - 12.90 | | 4 | 0,6 | BP6HS | 4511 | 18 | BPR7HIX | 5944 |
| 135 Favorit L / LS | 1.3 | | 04.88 - 95 | | 4 | 0,8 | BCPR5ES | 6130 | 32 | LPG 3 | 1498 |
| 135 Favorit LE / LSE | 1.3 | | 08.89 - 95 | | 4 | 0,8 | BKR6ES | 3783 | 28 | LPG 1 | 1496 |
| 135 Favorit LX / GLX | 1.3 | | 01.93 - 95 | | 4 | 0,8 | BKR6ES | 3783 | 28 | LPG 1 | 1496 |
| 135 Forman L / LS | 1.3 | | 08.90 - 95 | | 4 | 0,8 | BCPR5ES | 6130 | 32 | LPG 3 | 1498 |
| 135 Forman LE / LSE | 1.3 | | 02.91 - 95 | | 4 | 0,8 | BKR6ES | 3783 | 28 | LPG 1 | 1496 |
| 135 Forman LX / GLX | 1.3 | | 01.93 - 95 | | 4 | 0,8 | BKR6ES | 3783 | 28 | LPG 1 | 1496 |
| 135 L / GL / Rapid | 1.3 | 43 | 08.87 - 08.90 | u.Cat. | 4 | 0,8 | BCPR5ES | 6130 | 32 | LPG 3 | 1498 |
| 135 LE / LSE | 1.3 | | 08.89 - 08.92 | | 4 | 0,8 | BKR6ES | 3783 | 28 | LPG 1 | 1496 |
| 135 LX / GLX | 1.3 | | 01.93 - 96 | | 4 | 0,8 | BKR6ES | 3783 | 28 | LPG 1 | 1496 |
| 136 Favorit | | | | | 4 | 0,8 | BCPR6E | 1269 | 12 | LPG 3 | 1498 |
| 136 Favorit | | | | | 4 | 0,6 | BP7EFS | 3526 | | | |
| 136 Favorit | | | 93 - 95 | | 4 | | BCPR6ET | 2197 | | LPG 3 | 1498 |
| 136 Favorit | | | 93 - 95 | | 4 | 0,9 | BKR6E | 6962 | 28 | LPG 1 | 1496 |
| 136 L / GL / Rapid | 1.3 | 46 | 87 - 12.90 | | 4 | 0,7 | BKP6ES | 4930 | 17 | LPG 3 | 1498 |
| Coupe | 1.2 | 43 | - 12.90 | | 4 | 0,6 | BP6HS | 4511 | 18 | BPR7HIX | 5944 |
| Fabia | 1.0 | 37 | 10.00 - 08.02 | AQV | 4 | | BKR6ETA-10 | 7998 | | | |
| Fabia | 1.0 | 37 | 10.00 - 08.02 | ARV | 4 | | BKR6ETA-10 | 7998 | | | |
| Fabia | 1.0 | 37 | 02.00 - | ATY | 4 | | BKR6ETA-10 | 7998 | | | |



ℓ kW



Cyl.

Order-
No. No.LPG/CNG
D-PowerOrder-
No.**SKODA**

| | | | | | | | | | | | |
|------------------------------------|-----|-----|---------------|-------------------|---|-----|------------|------|----|------------|------|
| Fabia | 1.2 | 40 | 07.01 - 05.04 | AWY | 3 | 0,9 | ZFR5P-G | 6893 | | LPG 6 | 1565 |
| Fabia | 1.2 | 44 | 12.06 - 03.09 | BBM | 3 | 0,9 | ZFR5P-G | 6893 | | LPG 6 | 1565 |
| Fabia | 1.2 | 44 | 03.09 - | CHFA | 3 | 1,1 | ZFR6T-11G | 5960 | | ZFR6T-11G | 5960 |
| Fabia | 1.2 | 47 | 01.03 - 12.04 | AZQ | 3 | 0,9 | ZFR5P-G | 6893 | | LPG 6 | 1565 |
| Fabia | 1.2 | 51 | 03.09 - | CGPA | 4 | 1,1 | ZFR6T-11G | 5960 | | ZFR6T-11G | 5960 |
| Fabia | 1.4 | 44 | 04.00 - 03.03 | AZE | 4 | 0,8 | PFR6Q | 6458 | 37 | LPG 1 | 1496 |
| Fabia | 1.4 | 44 | 04.00 - 03.03 | AZF | 4 | 0,8 | PFR6Q | 6458 | 37 | LPG 1 | 1496 |
| Fabia | 1.4 | 50 | 08.99 - 05.03 | AME | 4 | | BKUR5ET-10 | 7553 | | LPG 1 | 1496 |
| Fabia | 1.4 | 50 | 08.00 - 05.03 | AQW | 4 | | BKUR5ET-10 | 7553 | | LPG 1 | 1496 |
| Fabia | 1.4 | 50 | 08.99 - 01.01 | ATZ | 4 | | BKUR5ET-10 | 7553 | | LPG 1 | 1496 |
| Fabia | 1.4 | 55 | 10.99 - 08.03 | AUA | 4 | | BKUR6ET-10 | 2397 | 24 | LPG 1 | 1496 |
| Fabia | 1.4 | 59 | 05.06 - 12.07 | BUD | 4 | 1,1 | ZFR6T-11G | 5960 | | ZFR6T-11G | 5960 |
| Fabia | 1.4 | 63 | 01.07 - | BXW | 4 | 1,1 | ZFR6T-11G | 5960 | | ZFR6T-11G | 5960 |
| Fabia | 1.4 | 63 | 03.10 - | CGGB | 4 | 1,1 | ZFR6T-11G | 5960 | | ZFR6T-11G | 5960 |
| Fabia | 1.4 | 74 | 10.99 - 08.03 | AUB | 4 | | BKUR6ET-10 | 2397 | 24 | LPG 1 | 1496 |
| Fabia | 1.4 | 74 | 05.02 - 12.07 | BBZ | 4 | | BKUR6ET-10 | 2397 | 24 | LPG 1 | 1496 |
| Fabia | 1.4 | 132 | 05.10 - | CAVE | 4 | 0,9 | PZFR6R | 5758 | | PZFR6R | 5758 |
| Fabia | 1.6 | 77 | 04.07 - | BTS | 4 | 1,1 | ZFR6T-11G | 5960 | | ZFR6T-11G | 5960 |
| Fabia | 1.6 | 77 | 06.10 - | CFNA | 4 | 1,1 | ZFR6T-11G | 5960 | | ZFR6T-11G | 5960 |
| Fabia | 2.0 | 85 | 12.99 - 12.07 | AZL | 4 | | BKUR6ET-10 | 2397 | 24 | LPG 1 | 1496 |
| Fabia 16 V | 1.4 | 55 | 05.04 - 12.07 | BKY | 4 | 0,9 | ZFR5P-G | 6893 | | LPG 6 | 1565 |
| Fabia 16V Automatic | 1.4 | 55 | 04.02 - 05.04 | BBY | 4 | 1,1 | PZFR5D-11 | 7968 | 34 | LPG 6 | 1565 |
| Fabia 16V Schaltgetriebe / gearbox | 1.4 | 55 | 04.02 - 05.04 | BBY | 4 | | BKUR6ET-10 | 2397 | 24 | LPG 1 | 1496 |
| Fabia Fgst → 5J-8B501225 | 1.2 | 52 | 01.07 - 05.09 | BZG | 3 | 0,9 | ZFR5P-G | 6893 | | LPG 6 | 1565 |
| Fgst → 5J-83074394 | | | | | | | | | | | |
| Fabia Fgst 5J-8B501226 → | 1.2 | 52 | 01.07 - 05.09 | BZG | 3 | 1,1 | ZFR6T-11G | 5960 | | ZFR6T-11G | 5960 |
| Fgst 5J-83074395 → | | | | | | | | | | | |
| Fabia Fgst 5J-8B501226 → | 1.2 | 52 | 01.08 - 09.10 | CEVA | 3 | 1,1 | ZFR6T-11G | 5960 | | ZFR6T-11G | 5960 |
| Fgst 5J-83074395 → | | | | | | | | | | | |
| Fabia Automatic | 1.4 | 55 | 10.99 - 08.03 | AUA | 4 | 1,1 | PZFR5D-11 | 7968 | 34 | LPG 6 | 1565 |
| Fabia Fgst → 6Y-8B451106 | 1.2 | 40 | 05.04 - 12.07 | BMD | 3 | 0,9 | ZFR5P-G | 6893 | | LPG 6 | 1565 |
| Fgst → 6Y-84035536 | | | | | | | | | | | |
| Fabia Fgst → 6Y-8B451106 | 1.2 | 47 | 11.04 - 12.07 | BME | 3 | 0,9 | ZFR5P-G | 6893 | | LPG 6 | 1565 |
| Fgst → 6Y-84035536 | | | | | | | | | | | |
| Fabia Fgst 6Y-8B451107 → | 1.2 | 40 | 05.04 - 12.07 | BMD | 3 | 1,1 | ZFR6T-11G | 5960 | | ZFR6T-11G | 5960 |
| Fgst 6Y-84035537 → | | | | | | | | | | | |
| Fabia Fgst 6Y-8B451107 → | 1.2 | 47 | 11.04 - 12.07 | BME | 3 | 1,1 | ZFR6T-11G | 5960 | | ZFR6T-11G | 5960 |
| Fgst 6Y-84035537 → | | | | | | | | | | | |
| Fabia RS TDI | 1.9 | 96 | 06.03 - 10.05 | ASZ | 4 | █ | Y-741U | 6943 | | D-POWER 20 | 6943 |
| Fabia RS TDI | 1.9 | 96 | 10.05 - 04.07 | BLT | 4 | █ | Y-741U | 6943 | | D-POWER 20 | 6943 |
| Fabia SDI | 1.9 | 47 | 11.99 - 03.08 | ASY | 4 | █ | Y-732J | 5605 | | D-POWER 4 | 5605 |
| Fabia TDI | 1.2 | 55 | 03.10 - | CFWA | 4 | █ | Y1002AS | 8888 | | D-POWER 57 | 8888 |
| Fabia TDI | 1.4 | 50 | 10.05 - | BNM | 3 | █ | Y-741U | 6943 | | D-POWER 20 | 6943 |
| Fabia TDI | 1.4 | 55 | 04.03 - 10.05 | AMF | 3 | █ | Y-741U | 6943 | | D-POWER 20 | 6943 |
| Fabia TDI | 1.4 | 59 | 01.07 - | BMS | 3 | █ | CZ104 | 9826 | | D-POWER 52 | 9826 |
| Fabia TDI | 1.4 | 59 | 10.05 - | BNV | 3 | █ | Y-741U | 6943 | | D-POWER 20 | 6943 |
| Fabia TDI | 1.6 | 55 | 04.10 - | CAYA | 4 | █ | Y1002AS | 8888 | | D-POWER 57 | 8888 |
| Fabia TDI | 1.6 | 66 | 03.10 - | CAYB | 4 | █ | Y1002AS | 8888 | | D-POWER 57 | 8888 |
| Fabia TDI | 1.6 | 77 | 03.10 - | CAYC | 4 | █ | Y1002AS | 8888 | | D-POWER 57 | 8888 |
| Fabia TDI | 1.9 | 74 | 10.05 - 12.07 | AXR | 4 | █ | Y-741U | 6943 | | D-POWER 20 | 6943 |
| Fabia TDI | 1.9 | 74 | 01.00 - 10.05 | ATD →6Y-2-451087 | 4 | █ | Y-732J | 5605 | | D-POWER 4 | 5605 |
| Fabia TDI | 1.9 | 74 | 01.00 - 10.05 | ATD 6Y-2-451088 → | 4 | █ | Y-741U | 6943 | | D-POWER 20 | 6943 |

Fgst = Chassis No.



ℓ kW



Cyl.

Order-
No.VLINE
No.LPG/CNG
D-PowerOrder-
No.**SKODA**

| | | | | | | | | | | | |
|----------------------------------|-----|-----|-------------|-------|---|-----|------------|------|----|------------|------|
| Fabia TDI | 1.9 | 77 | 04.07 - | BLS | 4 | █ | CZ104 | 9826 | | D-POWER 52 | 9826 |
| Fabia TDI | 1.9 | 77 | 04.07 - | BSW | 4 | █ | Y-741U | 6943 | | D-POWER 20 | 6943 |
| Felicia | 1.0 | 37 | 08.99 - | AHT | 4 | | BKR6ETA-10 | 7998 | | | |
| Felicia | 1.3 | 40 | 08.96-08.01 | AMG | 4 | | BKUR5ET-10 | 7553 | | LPG 1 | 1496 |
| Felicia | 1.3 | 43 | 10.94-07.96 | | 4 | 0,8 | BCPR5ES | 6130 | 32 | LPG 3 | 1498 |
| Felicia | 1.3 | 50 | 08.96-08.01 | AMH | 4 | | BKUR5ET-10 | 7553 | | LPG 1 | 1496 |
| Felicia | 1.4 | 74 | 99 - | | 4 | | BKUR6ET-10 | 2397 | 24 | LPG 1 | 1496 |
| Felicia | 1.6 | 55 | 05.95-08.01 | AEE | 4 | | BUR6ET | 3172 | 1 | LPG 2 | 1497 |
| Felicia 135i | 1.3 | 40 | 10.94-07.96 | MPI | 4 | | BKUR5ET-10 | 7553 | | LPG 1 | 1496 |
| Felicia 135i | 1.3 | 43 | 08.96 - | AMJ | 4 | 0,8 | BCPR5ES | 6130 | 32 | LPG 3 | 1498 |
| Felicia 136i | 1.3 | 50 | 10.94-07.96 | 136B | 4 | 0,8 | BCPR6ES | 2330 | 12 | LPG 3 | 1498 |
| Felicia 136i | 1.3 | 50 | 10.94-07.96 | 136M | 4 | 0,8 | BKR6ES | 3783 | 28 | LPG 1 | 1496 |
| Felicia D | 1.9 | 47 | 10.95-08.01 | AEF | 4 | █ | Y-918J | 6285 | | D-POWER 2 | 6285 |
| Felicia D | 1.9 | 47 | 97 - | AEY | 4 | █ | Y-732J | 5605 | | D-POWER 4 | 5605 |
| Octavia | 1.2 | 77 | 02.10 - | CBZB | 4 | 0,8 | PFR7S8EG | 1675 | | | |
| Octavia | 1.4 | 44 | 02.99-03.01 | AMD | 4 | | BKUR6ET-10 | 2397 | 24 | LPG 1 | 1496 |
| Octavia | 1.4 | 55 | 05.99 - | AHW | 4 | | BKUR6ET-10 | 2397 | 24 | LPG 1 | 1496 |
| Octavia | 1.4 | 55 | 00 - | AKQ | 4 | | BKUR6ET-10 | 2397 | 24 | LPG 1 | 1496 |
| Octavia | 1.4 | 55 | 00 - | APE | 4 | | BKUR6ET-10 | 2397 | 24 | LPG 1 | 1496 |
| Octavia | 1.4 | 55 | 01.02 - | BCA | 4 | | BKUR6ET-10 | 2397 | 24 | LPG 1 | 1496 |
| Octavia | 1.4 | 59 | 05.06 - | BUD | 4 | 1,1 | ZFR6T-11G | 5960 | | ZFR6T-11G | 5960 |
| Octavia | 1.4 | 90 | 11.08 - | CAXA | 4 | 0,9 | PZFR6R | 5758 | | PZFR6R | 5758 |
| Octavia | 1.6 | 55 | 10.96-09.04 | AEE | 4 | | BUR6ET | 3172 | 1 | LPG 2 | 1497 |
| Octavia | 1.6 | 74 | 02.97 - | AEH | 4 | | BKUR6ET-10 | 2397 | 24 | LPG 1 | 1496 |
| Octavia | 1.6 | 74 | 08.98 - | AKL | 4 | | BKUR6ET-10 | 2397 | 24 | LPG 1 | 1496 |
| Octavia | 1.6 | 75 | 08.00-04.02 | AVU | 4 | | BKUR6ET-10 | 2397 | 24 | LPG 1 | 1496 |
| Octavia | 1.6 | 75 | 04.02 - | BFQ | 4 | | BKUR6ET-10 | 2397 | 24 | LPG 1 | 1496 |
| Octavia | 1.6 | 75 | 05.04-05.05 | BGU | 4 | | BKUR6ET-10 | 2397 | 24 | LPG 1 | 1496 |
| Octavia | 1.6 | 75 | 05.05 - | BSE | 4 | | BKUR6ET-10 | 2397 | 24 | LPG 1 | 1496 |
| Octavia | 1.6 | 75 | 05.05 - | BSF | 4 | | BKUR6ET-10 | 2397 | 24 | LPG 1 | 1496 |
| Octavia | 1.6 | 75 | 11.07-05.10 | CCSA | 4 | | BKUR6ET-10 | 2397 | 24 | LPG 1 | 1496 |
| Octavia | 1.6 | 75 | 05.10 - | CMXA | 4 | | BKUR6ET-10 | 2397 | 24 | LPG 1 | 1496 |
| Octavia | 1.6 | 85 | 02.04-10.08 | BLF | 4 | | ZFR6S-Q | 6449 | | ZFR6S-Q | 6449 |
| Octavia | 1.8 | 110 | 98 - | AEB | 4 | 0,8 | PFR6Q | 6458 | 37 | LPG 1 | 1496 |
| Octavia | 1.8 | 110 | 05.98 - | AGU | 4 | 0,8 | PFR6Q | 6458 | 37 | LPG 1 | 1496 |
| Octavia | 1.8 | 112 | 03.09 - | CDAB | 4 | 0,8 | PFR7S8EG | 1675 | | | |
| Octavia | 1.8 | 118 | 06.07-10.08 | BZB | 4 | 0,8 | PFR7S8EG | 1675 | | | |
| Octavia | 1.8 | 118 | 11.08 - | CDA A | 4 | 0,8 | PFR7S8EG | 1675 | | | |
| Octavia | 2.0 | 85 | 09.00-01.05 | AEG | 4 | | BKUR6ET-10 | 2397 | 24 | LPG 1 | 1496 |
| Octavia | 2.0 | 85 | 05.99-05.07 | APK | 4 | | BKUR6ET-10 | 2397 | 24 | LPG 1 | 1496 |
| Octavia | 2.0 | 85 | 05.99-03.02 | AQY | 4 | | BKUR6ET-10 | 2397 | 24 | LPG 1 | 1496 |
| Octavia | 2.0 | 85 | 11.99 - | AZH | 4 | | BKUR6ET-10 | 2397 | 24 | LPG 1 | 1496 |
| Octavia | 2.0 | 85 | 03.02-01.06 | AZJ | 4 | 1,1 | PZFR5D-11 | 7968 | 34 | LPG 6 | 1565 |
| Octavia | 2.0 | 110 | 11.04-11.05 | BLR | 4 | | PZFR5N-11T | 7742 | | PZFR5N-11T | 7742 |
| Octavia | 2.0 | 110 | 11.04-11.05 | BLX | 4 | | PZFR5N-11T | 7742 | | PZFR5N-11T | 7742 |
| Octavia | 2.0 | 110 | 11.04-11.05 | BLY | 4 | 0,9 | BKR6E | 6962 | 28 | LPG 1 | 1496 |
| Octavia | 2.0 | 110 | 11.05-10.08 | BVX | 4 | | PZFR5N-11T | 7742 | | PZFR5N-11T | 7742 |
| Octavia | 2.0 | 110 | 11.05-10.08 | BVY | 4 | | PZFR5N-11T | 7742 | | PZFR5N-11T | 7742 |
| Octavia | 2.0 | 110 | 11.05-10.08 | BVZ | 4 | 0,9 | BKR6E | 6962 | 28 | LPG 1 | 1496 |
| Octavia | 2.0 | 147 | 11.08 - | CCZA | 4 | 0,8 | PFR7S8EG | 1675 | | | |
| Octavia Automatik | 1.4 | 55 | 08.00-01.02 | AXP | 4 | 1,1 | PZFR5D-11 | 7968 | 34 | LPG 6 | 1565 |
| Octavia Schaltgetriebe / gearbox | 1.4 | 55 | 08.00-01.02 | AXP | 4 | | BKUR6ET-10 | 2397 | 24 | LPG 1 | 1496 |



ℓ kW

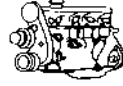

Cyl.

Order-
No. No.LPG/CNG
D-PowerOrder-
No.**SKODA**

| | | | | | | | | | | | |
|--|-----|-----|---------------|--------|---|-----|------------|------|----|------------|------|
| Octavia LPG | 1.6 | 75 | 08.09 - | CHGA | 4 | | BKUR6ET-10 | 2397 | 24 | LPG 1 | 1496 |
| Octavia SDI | 1.9 | 47 | 09.96 - | AEY | 4 | █ | Y-732J | 5605 | | D-POWER 4 | 5605 |
| Octavia SDI | 1.9 | 50 | 05.97 - | AGP | 4 | █ | Y-732J | 5605 | | D-POWER 4 | 5605 |
| Octavia SDI | 1.9 | 50 | 08.00 - 12.03 | AQM | 4 | █ | Y-732J | 5605 | | D-POWER 4 | 5605 |
| Octavia TD (SK) | 1.9 | 50 | 97 - | | 4 | █ | Y-918J | 6285 | | D-POWER 2 | 6285 |
| Octavia TDI | 1.6 | 77 | 06.09 - | CAYC | 4 | █ | Y1002AS | 8888 | | D-POWER 57 | 8888 |
| Octavia TDI | 1.6 | 77 | 06.09 - | CAYC | 4 | █ | Y1002AS | 8888 | | D-POWER 57 | 8888 |
| Octavia TDI | 1.9 | 66 | 97 - | 1Z | 4 | █ | Y-732J | 5605 | | D-POWER 4 | 5605 |
| Octavia TDI | 1.9 | 66 | 10.96 - | AGR | 4 | █ | Y-732J | 5605 | | D-POWER 4 | 5605 |
| Octavia TDI | 1.9 | 66 | 08.00 - | ALH | 4 | █ | Y-732J | 5605 | | D-POWER 4 | 5605 |
| Octavia TDI | 1.9 | 74 | 08.00 - 01.06 | ATD | 4 | █ | Y-732J | 5605 | | D-POWER 4 | 5605 |
| Octavia TDI | 1.9 | 77 | 05.04 - | BJB | 4 | █ | Y-607AS | 7560 | | D-POWER 50 | 7560 |
| Octavia TDI | 1.9 | 77 | 05.04 - 02.06 | BKC | 4 | █ | Y-607AS | 7560 | | D-POWER 50 | 7560 |
| Octavia TDI | 1.9 | 77 | 05.06 - | BLS | 4 | █ | Y-607AS | 7560 | | D-POWER 50 | 7560 |
| Octavia TDI | 1.9 | 77 | 03.06 - | BXE | 4 | █ | Y-607AS | 7560 | | D-POWER 50 | 7560 |
| Octavia TDI | 1.9 | 81 | 97 - | AFN | 4 | █ | Y-732J | 5605 | | D-POWER 4 | 5605 |
| Octavia TDI | 1.9 | 81 | 08.97 - 01.06 | AHF | 4 | █ | Y-732J | 5605 | | D-POWER 4 | 5605 |
| Octavia TDI | 1.9 | 81 | 10.00 - | ASV | 4 | █ | Y-732J | 5605 | | D-POWER 4 | 5605 |
| Octavia TDI | 1.9 | 96 | 09.02 - 09.04 | ASZ | 4 | █ | Y-741U | 6943 | | D-POWER 20 | 6943 |
| Octavia TDI | 2.0 | 81 | 03.10 - | CLCA | 4 | █ | Y1002AS | 8888 | | D-POWER 57 | 8888 |
| Octavia TDI | 2.0 | 100 | 05.04 - 10.08 | AZV | 4 | █ | YE14 | 7768 | | D-POWER 48 | 7768 |
| Octavia TDI | 2.0 | 100 | 05.04 - | BKD | 4 | █ | YE14 | 7768 | | D-POWER 48 | 7768 |
| Octavia TDI | 2.0 | 103 | 11.05 - | BMM | 4 | █ | Y-607AS | 7560 | | D-POWER 50 | 7560 |
| Octavia TDI | 2.0 | 103 | 03.10 - | CFHC | 4 | █ | Y1002AS | 8888 | | D-POWER 57 | 8888 |
| Octavia TDI | 2.0 | 103 | 02.10 - | CLCB | 4 | █ | Y1002AS | 8888 | | D-POWER 57 | 8888 |
| Octavia TDI | 2.0 | 125 | 04.06 - | BMN | 4 | █ | CZ304 | 9864 | | D-POWER 55 | 9864 |
| Octavia TDI | 2.0 | 125 | 05.08 - | CEGA | 4 | █ | Y1002AS | 8888 | | D-POWER 57 | 8888 |
| Octavia TDI | 2.0 | 125 | 04.06 - | BMN | 4 | █ | Y1002AS | 8888 | | D-POWER 57 | 8888 |
| Octavia TDI | 2.0 | 125 | 04.06 - | CEGA | 4 | █ | Y1002AS | 8888 | | D-POWER 57 | 8888 |
| Octavia TDI Fgst → 1U-22598796 Fgst → 1U-28558122 | 1.9 | 74 | 10.05 - | AXR | 4 | █ | Y-732J | 5605 | | D-POWER 4 | 5605 |
| Octavia TDI Fgst 1U-22598797 → Fgst 1U-28558123 → | 1.9 | 74 | 10.05 - | AXR | 4 | █ | Y-741U | 6943 | | D-POWER 20 | 6943 |
| Octavia 20V | 1.8 | 92 | 10.96 - | AGN | 4 | | BKUR6ET-10 | 2397 | 24 | LPG 1 | 1496 |
| Octavia Combi GLX / SLX | 2.0 | 88 | 11.99 - | ATF | 4 | 1,1 | PZFR5D-11 | 7968 | 34 | LPG 6 | 1565 |
| Octavia RS | 2.0 | 147 | 10.05 - 10.08 | BWA | 4 | 0,8 | PFR7S8EG | 1675 | | | |
| Octavia RS Turbo | 1.8 | 132 | 12.00 - 01.06 | AUQ | 4 | 0,8 | PFR6Q | 6458 | 37 | LPG 1 | 1496 |
| Octavia Turbo | 1.8 | 110 | 08.00 - 05.06 | ARX | 4 | 0,8 | PFR6Q | 6458 | 37 | LPG 1 | 1496 |
| Octavia Turbo | 1.8 | 110 | 01.00 - 07.00 | ARZ | 4 | 0,8 | PFR6Q | 6458 | 37 | LPG 1 | 1496 |
| Octavia Turbo | 1.8 | 110 | 08.00 - | AUM | 4 | 0,8 | PFR6Q | 6458 | 37 | LPG 1 | 1496 |
| Pickup | 1.9 | 47 | 97 - | AEY | 4 | █ | Y-732J | 5605 | | D-POWER 4 | 5605 |
| Pickup 135 L | 1.3 | | 06.90 - 96 | u.Cat. | 4 | 0,8 | BCPR5ES | 6130 | 32 | LPG 3 | 1498 |
| Pickup 135 LE | 1.3 | | 10.91 - 96 | | 4 | 0,8 | BKR6ES | 3783 | 28 | LPG 1 | 1496 |
| Pickup 135 LX | 1.3 | | 01.93 - 96 | | 4 | 0,8 | BKR6ES | 3783 | 28 | LPG 1 | 1496 |
| Pick-up 135i | 1.3 | 40 | 96 - | 135M | 4 | | BKUR5ET-10 | 7553 | | LPG 1 | 1496 |
| Pick-up 136i | 1.3 | 50 | 96 - | 136M | 4 | | BKUR5ET-10 | 7553 | | LPG 1 | 1496 |
| Rapid | 1.3 | | | | 4 | 0,6 | BP6HS | 4511 | 18 | BPR6HIX | 4085 |
| Rapid | 1.3 | | 91 - 92 | | 4 | 0,7 | BP5EFS | 3712 | | | |
| Roomster | 1.2 | 51 | 03.09 - | CGPA | 3 | 1,1 | ZFR6T-11G | 5960 | | ZFR6T-11G | 5960 |
| Roomster | 1.4 | 63 | 05.06 - | BXW | 4 | 1,1 | ZFR6T-11G | 5960 | | ZFR6T-11G | 5960 |
| Roomster | 1.4 | 63 | 03.10 - | CGGB | 4 | 1,1 | ZFR6T-11G | 5960 | | ZFR6T-11G | 5960 |
| Roomster | 1.6 | 77 | 05.06 - | BTS | 4 | 1,1 | ZFR6T-11G | 5960 | | ZFR6T-11G | 5960 |

Fgst = Chassis No.



ℓ kW

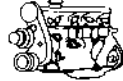

Cyl.

Order-
No. No.LPG/CNG
D-PowerOrder-
No.**SKODA**

| | | | | | | | | | | | |
|-----------------------------|-----|-----|---------------|-------|---|-----|------------|------|----|------------|------|
| Roomster | 1.6 | 77 | 06.10 - | CFNA | 4 | 1,1 | ZFR6T-11G | 5960 | | ZFR6T-11G | 5960 |
| Roomster Fgst → 5J-8B600480 | 1.2 | 47 | 05.06 - 01.07 | BME | 3 | 0,9 | ZFR5P-G | 6893 | | LPG 6 | 1565 |
| Fgst → 5J-85036340 | | | | | | | | | | | |
| Roomster Fgst → 5J-8B600480 | 1.2 | 52 | 01.07 - 03.09 | BZG | 3 | 0,9 | ZFR5P-G | 6893 | | LPG 6 | 1565 |
| Fgst → 5J-85036340 | | | | | | | | | | | |
| Roomster Fgst 5J-8B600481 → | 1.2 | 47 | 05.06 - 01.07 | BME | 3 | 1,1 | ZFR6T-11G | 5960 | | ZFR6T-11G | 5960 |
| Fgst 5J-85036341 → | | | | | | | | | | | |
| Roomster Fgst 5J-8B600481 → | 1.2 | 52 | 01.07 - 03.09 | BZG | 3 | 1,1 | ZFR6T-11G | 5960 | | ZFR6T-11G | 5960 |
| Fgst 5J-85036341 → | | | | | | | | | | | |
| Roomster TDI | 1.2 | 55 | 03.10 - | CFWA | 3 | █ | Y1002AS | 8888 | | D-POWER 57 | 8888 |
| Roomster TDI | 1.4 | 50 | 07.06 - | BNM | 3 | █ | Y-741U | 6943 | | D-POWER 20 | 6943 |
| Roomster TDI | 1.4 | 59 | 07.06 - | BMS | 3 | █ | CZ104 | 9826 | | D-POWER 52 | 9826 |
| Roomster TDI | 1.4 | 59 | 05.06 - | BNV | 3 | █ | Y-741U | 6943 | | D-POWER 20 | 6943 |
| Roomster TDI | 1.6 | 66 | 03.10 - | CAYB | 4 | █ | Y1002AS | 8888 | | D-POWER 57 | 8888 |
| Roomster TDI | 1.6 | 77 | 03.10 - | CAYC | 4 | █ | Y1002AS | 8888 | | D-POWER 57 | 8888 |
| Roomster TDI | 1.9 | 74 | 03.06 - 05.06 | AXR | 4 | █ | Y-741U | 6943 | | D-POWER 20 | 6943 |
| Roomster TDI | 1.9 | 77 | 11.06 - | BLS | 4 | █ | CZ104 | 9826 | | D-POWER 52 | 9826 |
| Roomster TDI | 1.9 | 77 | 05.06 - | BSW | 4 | █ | Y-741U | 6943 | | D-POWER 20 | 6943 |
| S100,L | 1.0 | 28 | - 81 | | 4 | 0,6 | BP6HS | 4511 | 18 | BPR7HIX | 5944 |
| S110,L,LS,R | 1.1 | | - 81 | | 4 | 0,8 | BP7HS | 5111 | | BPR8HIX | 6742 |
| Superb | 1.4 | 92 | 08.08 - | CAXC | 4 | 0,9 | PZFR6R | 5758 | | PZFR6R | 5758 |
| Superb | 1.8 | 110 | 10.01 - 03.08 | AWT | 4 | | PFR6Q | 6458 | 37 | LPG 1 | 1496 |
| Superb | 1.8 | 112 | 03.09 - | CDAB | 4 | 0,8 | PFR7S8EG | 1675 | | | |
| Superb | 1.8 | 118 | 03.08 - 05.09 | BZB | 4 | 0,8 | PFR7S8EG | 1675 | | | |
| Superb | 1.8 | 118 | 09.08 - | CDA A | 4 | 0,8 | PFR7S8EG | 1675 | | | |
| Superb | 2.0 | 85 | 12.01 - 03.08 | AZM | 4 | | BKUR6ET-10 | 2397 | 24 | LPG 1 | 1496 |
| Superb | 2.8 | 140 | 05.02 - 03.08 | BBG | 6 | | BKR6EKUB | 3584 | | LPG 1 | 1496 |
| Superb | 2.8 | 142 | 12.01 - 03.08 | AMX | 6 | | BKR6EKUB | 3584 | | LPG 1 | 1496 |
| Superb 3T-99006001> | 2.0 | 103 | 03.08 - | BMP | 4 | █ | CZ104 | 9826 | | D-POWER 52 | 9826 |
| Superb >3T-99006000 | 2.0 | 103 | 03.08 - | BMP | 4 | █ | CZ104 | 9826 | | D-POWER 52 | 9826 |
| Superb TDI | 1.6 | 77 | 09.10 - | CAYC | 4 | █ | Y1002AS | 8888 | | D-POWER 57 | 8888 |
| Superb TDI | 1.9 | 74 | 06.02 - 10.05 | AVB | 4 | █ | Y-741U | 6943 | | D-POWER 20 | 6943 |
| Superb TDI | 1.9 | 77 | 07.08 - | BLS | 4 | █ | Y-607AS | 7560 | | D-POWER 50 | 7560 |
| Superb TDI | 1.9 | 77 | 10.05 - 05.07 | BSV | 4 | █ | CZ104 | 9826 | | D-POWER 52 | 9826 |
| Superb TDI | 1.9 | 77 | 03.08 - | BXE | 4 | █ | Y-607AS | 7560 | | D-POWER 50 | 7560 |
| Superb TDI | 1.9 | 85 | 01.07 - 03.08 | BPZ | 4 | █ | CZ104 | 9826 | | D-POWER 52 | 9826 |
| Superb TDI | 1.9 | 96 | 01.04 - 03.08 | AVF | 4 | █ | Y-741U | 6943 | | D-POWER 20 | 6943 |
| Superb TDI | 1.9 | 96 | 10.01 - 03.08 | AWX | 4 | █ | Y-741U | 6943 | | D-POWER 20 | 6943 |
| Superb TDI | 2.0 | 100 | 01.09 - | BKD | 4 | █ | YE14 | 7768 | | D-POWER 48 | 7768 |
| Superb TDI | 2.0 | 103 | 10.05 - 03.08 | BSS | 4 | █ | CZ104 | 9826 | | D-POWER 52 | 9826 |
| Superb TDI | 2.0 | 103 | 03.10 - | CFFB | 4 | █ | Y1002AS | 8888 | | D-POWER 57 | 8888 |
| Superb TDI | 2.0 | 103 | 02.10 - | CLJA | 4 | █ | Y1002AS | 8888 | | D-POWER 57 | 8888 |
| Superb TDI | 2.0 | 125 | 06.08 - 05.10 | CBBB | 4 | █ | Y1002AS | 8888 | | D-POWER 57 | 8888 |
| Superb TDI | 2.0 | 125 | 05.10 - | CFG B | 4 | █ | Y1002AS | 8888 | | D-POWER 57 | 8888 |
| Superb TDI | 2.5 | 114 | 12.01 - 08.03 | AYM | 6 | █ | Y-501U | 3786 | | D-POWER 31 | 4187 |
| Superb TDI | 2.5 | 120 | 06.03 - 03.08 | BDG | 6 | █ | Y-501U | 3786 | | D-POWER 31 | 4187 |
| Yeti | 1.2 | 77 | 09.09 - | CBZB | 4 | 0,8 | PFR7S8EG | 1675 | | | |
| Yeti | 1.4 | 90 | 06.10 - | CAXA | 4 | 0,9 | PZFR6R | 5758 | | PZFR6R | 5758 |
| Yeti | 1.8 | 112 | 11.09 - | CDAB | 4 | 0,8 | PFR7S8EG | 1675 | | | |
| Yeti | 1.8 | 118 | 05.09 - | CDA A | 4 | 0,8 | PFR7S8EG | 1675 | | | |
| Yeti TDI | 2.0 | 81 | 11.09 - | CFHA | 4 | █ | Y1002AS | 8888 | | D-POWER 57 | 8888 |
| Yeti TDI | 2.0 | 81 | 11.09 - | CFHF | 4 | █ | Y1002AS | 8888 | | D-POWER 57 | 8888 |

Fgst = Chassis No.



ℓ kW



Cyl.

Order-
No. No.LPG/CNG
D-PowerOrder-
No.**SKODA**

| | | | | | | | | | | | |
|----------|-----|-----|---------------|------|---|---|---------|------|--|------------|------|
| Yeti TDI | 2.0 | 103 | 05.09 - 11.09 | CBDB | 4 | ☑ | Y1002AS | 8888 | | D-POWER 57 | 8888 |
| Yeti TDI | 2.0 | 103 | 11.09 - | CFHC | 4 | ☑ | Y1002AS | 8888 | | D-POWER 57 | 8888 |
| Yeti TDI | 2.0 | 125 | 11.09 - 05.10 | CEGA | 4 | ☑ | Y1002AS | 8888 | | D-POWER 57 | 8888 |
| Yeti TDI | 2.0 | 125 | 11.09 - | CFJA | 4 | ☑ | Y1002AS | 8888 | | D-POWER 57 | 8888 |
| Yeti TDI | 2.0 | 81 | 11.09 - | CFHA | 4 | ☑ | Y1002AS | 8888 | | D-POWER 57 | 8888 |

SMART

| | | | | | | | | | | | |
|-----------------------|-----|-----|---------------|----------------------|---|-----|-----------|------|--|------------|------|
| Smart | 0.6 | 33 | 10.98 - 01.04 | M 160 ... Twin Spark | 3 | | BKR6EKE | 5649 | | | |
| Smart | 0.6 | 40 | 10.98 - 01.04 | M 160 ... Twin Spark | 3 | | BKR6EKE | 5649 | | | |
| Smart | 0.7 | 37 | 10.02 - 01.04 | M 160/1 Twin Spark | 3 | | LKR8A | 5214 | | LKR8A | 5214 |
| Smart | 0.7 | 60 | 10.02 - 01.04 | M 160/1 Twin Spark | 3 | | LKR8A | 5214 | | LKR8A | 5214 |
| Smart CDI | 0.8 | 29 | 07.98 - 01.04 | OM 660 DE 08 LA | 3 | ☑ | Y-543J | 5618 | | D-POWER 46 | 5618 |
| Smart Crossblade | 0.6 | 52 | 10.02 - 01.04 | M 160 ... Twin Spark | 3 | | BKR6EKE | 5649 | | | |
| Smart forfour | 1.1 | 55 | 01.04 - 06 | M 134.910 | 3 | 1,1 | LFR6C-11 | 5788 | | | |
| Smart forfour | 1.3 | 70 | 01.04 - 06 | M 135.930 | 4 | 1,1 | LFR6C-11 | 5788 | | | |
| Smart forfour | 1.5 | 80 | 01.04 - 06 | M 135.950 | 4 | 1,1 | LFR6C-11 | 5788 | | | |
| Smart forfour Brabus | 1.5 | 130 | 05.05 - | M 122.950 | 4 | 0,8 | ILZFR6C-K | 6645 | | ILZFR6C-K | 6645 |
| Smart forfour Cdi | 1.5 | 50 | 09.04 - | OM 639.939 | 3 | ☑ | YE13 | 8643 | | | |
| Smart forfour Cdi | 1.5 | 70 | 09.04 - | OM 639.939 | 3 | ☑ | YE13 | 8643 | | | |
| Smart fortwo | 0.7 | 37 | 01.04 - | M 160/1 Twin Spark | 3 | | LKR8A | 5214 | | LKR8A | 5214 |
| Smart fortwo | 0.7 | 45 | 01.04 - | M 160/1 Twin Spark | 3 | | LKR8A | 5214 | | LKR8A | 5214 |
| Smart fortwo Brabus | 1.0 | 72 | 01.08 - | M 132.930 | 3 | 0,9 | LKR7B-9 | 5847 | | LKR7B-9 | 5847 |
| Smart fortwo Cdi | 0.8 | 30 | 01.04 - | OM 660 | 3 | ☑ | Y-543J | 5618 | | D-POWER 46 | 5618 |
| Smart fortwo 2 | 1.0 | 45 | 03.07 - | M 132.910 | 3 | 0,9 | LKR7B-9 | 5847 | | LKR7B-9 | 5847 |
| Smart fortwo 2 | 1.0 | 52 | 03.07 - | M 132.910 | 3 | 0,9 | LKR7B-9 | 5847 | | LKR7B-9 | 5847 |
| Smart fortwo 2 Turbo | 1.0 | 62 | 03.07 - | M 132.930 | 3 | 0,9 | LKR7B-9 | 5847 | | LKR7B-9 | 5847 |
| Smart Roadster | 0.7 | 45 | 10.02 - 11.05 | M 160/1 Twin Spark | 3 | | LKR8A | 5214 | | LKR8A | 5214 |
| Smart Roadster | 0.7 | 60 | 06.03 - 11.05 | M 160/1 Twin Spark | 3 | | LKR8A | 5214 | | LKR8A | 5214 |
| Smart Roadster Brabus | 0.7 | 74 | 12.03 - | M 160/1 Twin Spark | 3 | | LKR8A | 5214 | | LKR8A | 5214 |

SSANGYONG

| | | | | | | | | | | | |
|----------------------|-----|-----|---------------|------------------|---|-----|---------|------|----|-----------|------|
| Korando | 2.0 | 100 | 07.96 - | M161E20 M111.940 | 4 | 0,8 | BCP5ES | 7496 | 16 | LPG 3 | 1498 |
| Korando | 2.3 | 110 | 09.96 - 02.99 | M161E23 M111.970 | 4 | 0,8 | BCP5ES | 7496 | 16 | LPG 3 | 1498 |
| Korando | 3.2 | 162 | 09.96 - 03.00 | M162E32 M104... | 6 | 0,8 | BCP5ES | 7496 | 16 | LPG 3 | 1498 |
| Korando GPL | 3.2 | 162 | 07.97 - 03.00 | | 6 | 0,8 | BKR5EIX | 6341 | | BKR5EIX | 6341 |
| Korando D | 2.2 | 51 | 01.93 - | DC 23 | 4 | ☑ | Y-710J | 7880 | | | |
| Korando D | 2.3 | 55 | 03.97 - | OM 601 DM | 4 | ☑ | Y-916J | 5906 | | D-POWER 6 | 5906 |
| Korando D | 2.9 | 73 | 12.96 - | MB-OM 602 | 5 | ☑ | Y-916J | 5906 | | D-POWER 6 | 5906 |
| Korando TD | 2.3 | 73 | 03.99 - 03.00 | | 4 | ☑ | Y-916J | 5906 | | D-POWER 6 | 5906 |
| Korando TD | 2.9 | 88 | 03.99 - 03.00 | | 5 | ☑ | Y-916J | 5906 | | D-POWER 6 | 5906 |
| Musso | 2.0 | 100 | 05.96 - | M161E20 M111.940 | 4 | 0,8 | BCP5ES | 7496 | 16 | LPG 3 | 1498 |
| Musso | 2.3 | 110 | 05.96 - 02.99 | M161E23 M111.970 | 4 | 0,8 | BCP5ES | 7496 | 16 | LPG 3 | 1498 |
| Musso E32 | 3.2 | 162 | 01.96 - | M162E32 M104... | 6 | 0,8 | BCP5ES | 7496 | 16 | LPG 3 | 1498 |
| Musso 601 D | 2.3 | 58 | 07.93 - 01.00 | MB-OM 601 | 4 | ☑ | Y-916J | 5906 | | D-POWER 6 | 5906 |
| Musso 602 D | 2.9 | 73 | 07.93 - 01.00 | MB-OM 602 | 5 | ☑ | Y-916J | 5906 | | D-POWER 6 | 5906 |
| Musso Sports 290S TD | 2.9 | 88 | 03.04 - | | 5 | ☑ | Y-916J | 5906 | | D-POWER 6 | 5906 |
| Musso TD | 2.3 | 73 | 03.99 - 03.00 | | 4 | ☑ | Y-916J | 5906 | | D-POWER 6 | 5906 |
| Musso TD | 2.9 | 88 | 03.99 - | | 5 | ☑ | Y-916J | 5906 | | D-POWER 6 | 5906 |
| Rexton RX 290s | 2.9 | 88 | | | 5 | ☑ | Y-916J | 5906 | | D-POWER 6 | 5906 |
| Rexton RX 320s | 3.2 | 162 | | | 6 | 0,7 | BCP6ES | 4930 | 17 | LPG 3 | 1498 |



ℓ kW



Cyl.

Order-
No. No.LPG/CNG
D-PowerOrder-
No.**STEYR**

| | | | | | | | | | | | |
|--------------|-----|-----|---------|-----------|---|---|--------|------|--|-----------|------|
| Puch 290 GD | 2.9 | 72 | 08.93 - | OM602 | 5 | █ | Y-916J | 5906 | | D-POWER 6 | 5906 |
| Puch 300 GD | 3.0 | 83 | 09.89 - | OM617/603 | 6 | █ | Y-916J | 5906 | | D-POWER 6 | 5906 |
| Puch 350 GTD | 3.5 | 100 | 09.91 - | OM617/603 | 6 | █ | Y-916J | 5906 | | D-POWER 6 | 5906 |

SUBARU

| | | | | | | | | | | | |
|-----------------------|-----|-----|---------------|------------------------|---|-----|------------|------|----|-----------|------|
| 1800 Injection | 1.8 | 59 | 81 - 85 | EA81 | 4 | 0,7 | BP6ES | 7811 | 4 | LPG 2 | 1497 |
| Forester | 2.0 | 90 | 09.97 - 02 | EJ20J | 4 | 1,1 | BCPR6ES-11 | 7121 | 11 | LPG 3 | 1498 |
| Forester | 2.0 | 92 | 09.97 - | EJ20 | 4 | 1,1 | BKR6E-11 | 2756 | 14 | LPG 1 | 1496 |
| Forester | 2.0 | 110 | 01.08 - | EJ204 | 4 | 1,1 | SILFR6A11 | 5468 | | SILFR6A11 | 5468 |
| Forester | 2.0 | 116 | 03.08 - | EJ20 | 4 | 0,8 | ILFR6B | 6481 | | ILFR6B | 6481 |
| Forester | 2.0 | 116 | 09.05 - 02.08 | EJ20 | 4 | 0,8 | ILFR6B | 6481 | | ILFR6B | 6481 |
| Forester | 2.5 | 169 | 06 - 02.08 | EJ25 | 4 | 0,8 | ILFR6B | 6481 | | ILFR6B | 6481 |
| Forester | 2.5 | 169 | 06.08 - | EJ255 | 4 | 0,8 | ILFR6B | 6481 | | ILFR6B | 6481 |
| Forester 2.0 Turbo | 2.0 | 130 | 03.99 - 02 | EJ20 | 4 | 0,9 | PFR6B | 3500 | | PFR7B | 4853 |
| Forester 2.5 Turbo | 2.5 | 155 | 05 - | EJ25 | 4 | 0,8 | PFR6G | 4793 | | PFR7G | 4364 |
| Impreza | 1.6 | 70 | 03 - 06 | EJ16 | 4 | 0,8 | PFR6G | 4793 | | PFR7G | 4364 |
| Impreza | 1.6 | 70 | 12.00 - 03 | EJ16 | 4 | 1,1 | BKR6E-11 | 2756 | 14 | LPG 1 | 1496 |
| Impreza | 2.0 | 92 | 12.00 - | EJ20 | 4 | 1,1 | BKR6E-11 | 2756 | 14 | LPG 1 | 1496 |
| Impreza | 2.0 | 110 | 01.08 - | EJ204 | 4 | 1,1 | SILFR6A11 | 5468 | | SILFR6A11 | 5468 |
| Impreza 1,6 | 1.6 | 66 | 93 - 00 | EJ16 | 4 | 1,1 | BKR6E-11 | 2756 | 14 | LPG 1 | 1496 |
| Impreza 1,8 | 1.8 | 76 | 93 - 00 | EJ18 | 4 | 1,1 | BKR6E-11 | 2756 | 14 | LPG 1 | 1496 |
| Impreza 1.5R | 1.5 | 79 | 09.07 - | EJ15 | 4 | 0,8 | ILFR6B | 6481 | | ILFR6B | 6481 |
| Impreza 2.0 RS | 2.0 | 92 | 11.04 - | EJ20 | 4 | 1,1 | BKR6E-11 | 2756 | 14 | LPG 1 | 1496 |
| Impreza 2.0R | 2.0 | 110 | 09.07 - | EK20 | 4 | 0,8 | ILFR6B | 6481 | | ILFR6B | 6481 |
| Impreza 2.5 | 2.5 | 169 | 08 - | N/A | 4 | 0,8 | ILFR6B | 6481 | | ILFR6B | 6481 |
| Impreza R | 2.0 | 118 | 06 - | EJ20 | 4 | 0,8 | ILFR6B | 6481 | | ILFR6B | 6481 |
| Impreza Turbo | 2.0 | 155 | 05.94 - 07.96 | EJ20 | 4 | 0,8 | PFR6G | 4793 | | PFR7G | 4364 |
| Impreza Turbo | 2.0 | 160 | 03.94 - 00 | EJ20 | 4 | 0,9 | PFR6B | 3500 | | PFR7B | 4853 |
| Impreza WRX | 2.5 | 169 | 09.05 - | EJ25 | 4 | 0,8 | ILFR6B | 6481 | | ILFR6B | 6481 |
| Impreza WRX STI | 2.0 | 195 | 03 - | EJ20 | 4 | 0,8 | PFR6G | 4793 | | PFR7G | 4364 |
| Impreza WRX STI | 2.0 | 236 | 02.04 - | | 4 | 0,8 | PFR6G | 4793 | | PFR7G | 4364 |
| Impreza WRX STI | 2.5 | 206 | 06 - | EJ25 | 4 | 0,8 | ILFR6B | 6481 | | ILFR6B | 6481 |
| Impreza WRX STI (GRF) | 2.5 | 221 | 01.08 - | EJ25 | 4 | | SILFR6A | 7913 | | SILFR6A | 7913 |
| Impreza WRX STI St1 | 2.5 | 206 | 09.05 - | EJ25 | 4 | 0,8 | ILFR6B | 6481 | | ILFR6B | 6481 |
| Impreza WRX Turbo | 2.0 | 160 | 12.00 - | EJ20 | 4 | 0,9 | PFR6B | 3500 | | PFR7B | 4853 |
| Impreza WRX Turbo | 2.0 | 165 | 11.02 - | EJ20 | 4 | 0,9 | PFR6B | 3500 | | PFR7B | 4853 |
| Impreza WRX Turbo | 2.0 | 169 | 06 - | EJ25 | 4 | 0,8 | ILFR6B | 6481 | | ILFR6B | 6481 |
| Justy | 1.3 | 63 | - 03 | G13BB | 4 | 1,1 | BKR6E-11 | 2756 | 14 | LPG 1 | 1496 |
| Justy 1.0 | 1.0 | 52 | 07 - | 1KR-FE engine daihatsu | 3 | 1,1 | LFR6C-11 | 5788 | | | |
| Justy 1000 | 1.0 | | 85 - 03 | EF10 Cat. | 4 | 1,1 | BPR6ES-11 | 4824 | 13 | LPG 2 | 1497 |
| Justy 1200 | 1.2 | 55 | 87 - 03 | EF12/EF12 Cat. | 4 | 1,1 | BPR6ES-11 | 4824 | 13 | LPG 2 | 1497 |
| Justy 1300 | 1.3 | 50 | 10.95 - 03 | G13BA | 4 | 0,8 | BPR6ES | 7822 | 2 | LPG 2 | 1497 |
| Justy G3X | 1.3 | 69 | 09.03 - | M13A DOHC | 4 | 1,1 | BKR6E-11 | 2756 | 14 | LPG 1 | 1496 |
| Justy G3X | 1.5 | 73 | 09.03 - | M15A DOHC | 4 | 1,1 | IFR6J11 | 7658 | | IFR6J11 | 7658 |
| L-1800 | 1.8 | 66 | 85 - 89 | | 4 | 0,8 | BPR6ES | 7822 | 2 | LPG 2 | 1497 |
| L-1800 MPFJ | 1.8 | 72 | 87 - | EA82 | 4 | 1,1 | BPR6ES-11 | 4824 | 13 | LPG 2 | 1497 |
| L-1800 Turbo | 1.8 | 97 | 87 - 89 | EA82 u.Cat. | 4 | 0,8 | BPR7ES | 2023 | 19 | BPR8EIX | 6684 |
| L-1800 Turbo | 1.8 | 100 | 85 - 89 | EA82 | 4 | 0,8 | BPR7ES | 2023 | 19 | BPR8EIX | 6684 |
| Legacy | 2.0 | 85 | 05.94 - | EJ20 | 4 | 1,1 | BKR6E-11 | 2756 | 14 | LPG 1 | 1496 |
| Legacy | 2.0 | 101 | 09.03 - | EJ20 | 4 | 1,1 | BKR6E-11 | 2756 | 14 | LPG 1 | 1496 |
| Legacy | 2.2 | 94 | 05.94 - 02 | EJ22 | 4 | 1,1 | BKR6E-11 | 2756 | 14 | LPG 1 | 1496 |
| Legacy | 2.5 | 121 | 09.03 - | EJ25 | 4 | 1,1 | PFR5B-11 | 2300 | | PFR6B | 3500 |



ℓ kW



Cyl.

Order-
No. No.LPG/CNG
D-PowerOrder-
No.**SUBARU**

| | | | | | | | | | | | |
|----------------------------|------|-----|---------------|---------------|---|-----|-----------|------|----|---------|------|
| Legacy H6-3.0 | 3.0 | 154 | 01 - 03 | | 6 | 1,1 | PLFR6A-11 | 7654 | | LPG 7 | 1640 |
| Legacy 1,8 Sedan | 1.8 | 76 | 90 - 91 | EJ18/4 | 4 | 1,1 | BKR6E-11 | 2756 | 14 | LPG 1 | 1496 |
| Legacy 1,8 Station | 1.8 | 76 | 90 - 91 | EJ18/4 | 4 | 1,1 | BKR6E-11 | 2756 | 14 | LPG 1 | 1496 |
| Legacy 1,8 Super Station | 1.8 | 76 | 90 - 91 | EJ18/4 | 4 | 1,1 | BKR6E-11 | 2756 | 14 | LPG 1 | 1496 |
| Legacy 2,0 | 2.0 | 92 | 12.98 - 03 | EJ20 | 4 | 1,1 | BKR6E-11 | 2756 | 14 | LPG 1 | 1496 |
| Legacy 2,0 Sedan | 2.0 | 84 | 92 - 95 | EJ20/4 | 4 | 1,1 | BKR6E-11 | 2756 | 14 | LPG 1 | 1496 |
| Legacy 2,0 Super Station | 2.0 | 84 | 92 - 95 | EJ20 | 4 | 1,1 | BKR6E-11 | 2756 | 14 | LPG 1 | 1496 |
| Legacy 2,0 Turbo | 2.0 | 147 | 93 - 96 | EJ20 | 4 | 0,8 | PFR6G | 4793 | | PFR7G | 4364 |
| Legacy 2,0 Turbo Sedan | 2.0 | 147 | 92 - 93 | EJ20 | 4 | 0,8 | BKR6EVX | 3539 | | LPG 1 | 1496 |
| Legacy 2,0 Turbo Sup.Stat. | 2.0 | 147 | 92 - 93 | EJ20 | 4 | 0,8 | BKR6EVX | 3539 | | LPG 1 | 1496 |
| Legacy 2,2 Sedan | 2.2 | 100 | 90 - 93 | EJ22 | 4 | 1,1 | BKR6E-11 | 2756 | 14 | LPG 1 | 1496 |
| Legacy 2,2 Station | 2.2 | 96 | 94 - 02 | EJ22 | 4 | 1,1 | BKR6E-11 | 2756 | 14 | LPG 1 | 1496 |
| Legacy 2,2 Super Station | 2.2 | 100 | 90 - 94 | EJ22/4 | 4 | 1,1 | BKR6E-11 | 2756 | 14 | LPG 1 | 1496 |
| Legacy 2,5 Outback | 2.5 | 115 | 12.98 - 03 | EJ25 | 4 | 1,1 | BKR6E-11 | 2756 | 14 | LPG 1 | 1496 |
| Legacy 2.0 | 2.0 | 121 | 06.05 - | | 4 | 0,8 | ILFR6B | 6481 | | ILFR6B | 6481 |
| Legacy 3.0 R | 3.0 | 180 | 11.03 - | EZ30 | 6 | 0,8 | ILFR6B | 6481 | | ILFR6B | 6481 |
| Legacy 3.0R spec.B Kombi | 3.0 | 180 | 02.05 - | EZ30 | 6 | 0,8 | ILFR6B | 6481 | | ILFR6B | 6481 |
| Legacy Outback | 2.5 | 110 | 96 - 02 | EJ25 | 4 | 1,1 | PFR6B-11 | 4014 | | PFR7B | 4853 |
| Legacy Outback H6-3.0 | 3.0 | 154 | 01 - 03 | | 6 | 1,1 | PLFR6A-11 | 7654 | | LPG 7 | 1640 |
| Libero 1000 | 1.0 | 37 | - 86 | EF10 | 4 | 1,1 | BPR6ES-11 | 4824 | 13 | LPG 2 | 1497 |
| Libero 1200 | 1.2 | 38 | 87 - 00 | EF12 | 4 | 1,1 | BPR6ES-11 | 4824 | 13 | LPG 2 | 1497 |
| MV Pickup | 1.8 | | 80 - 94 | | 4 | 0,8 | BPR6ES | 7822 | 2 | LPG 2 | 1497 |
| Outback 2.5 | 2.5 | 121 | 09.03 - | EJ25 | 4 | 1,1 | PFR5B-11 | 2300 | | PFR6B | 3500 |
| Outback 3.0 R | 3.0 | 180 | 11.03 - | EZ30 | 6 | 0,8 | ILFR6B | 6481 | | ILFR6B | 6481 |
| Pleo (RA1,RA2) | 0.66 | | 10.01 - 01.04 | EN07 | 4 | | KR8BI | 4347 | | KR8BI | 4347 |
| R1 (RJ1,RJ2) | 0.66 | | 06 - | EN07 | 4 | | KR8BI | 4347 | | KR8BI | 4347 |
| R2 (RC1,RC2) | 0.66 | | 12.03 - | EN07 | 4 | | KR8BI | 4347 | | KR8BI | 4347 |
| SVX | 3.3 | 162 | 92 - 12.97 | EG33 | 6 | 1,1 | PFR6G-11 | 5555 | | PFR7G | 4364 |
| Tribeca B9 | 3.0 | 184 | 06 - | EZ30 | 6 | 0,8 | ILFR6B | 6481 | | ILFR6B | 6481 |
| Tribeca B9 | 3.6 | 190 | 09.07 - | EZ36D | 6 | | SILFR6A | 7913 | | SILFR6A | 7913 |
| Vivio | 0.7 | | 03.92 - | MFI | 4 | 1,1 | BKR6E-11 | 2756 | 14 | LPG 1 | 1496 |
| Vivio | 0.7 | | 03.92 - | Vergaser/Carb | 4 | 1,1 | BKR5E-11 | 6953 | 33 | LPG 1 | 1496 |
| XT Turbo | 1.8 | 88 | 90 - 90 | Cat. | 4 | 1,1 | BPR6ES-11 | 4824 | 13 | LPG 2 | 1497 |
| XT Turbo | 1.8 | 97 | 87 - 89 | u.Cat. | 4 | 0,8 | BPR7ES | 2023 | 19 | BPR8EIX | 6684 |
| XT-Turbo | 1.8 | 100 | 85 - 89 | | 4 | 0,8 | BPR7ES | 2023 | 19 | BPR8EIX | 6684 |

SUZUKI

| | | | | | | | | | | | |
|-------------------------|-----|----|---------------|---------------|---|-----|----------|------|----|-----------|------|
| Alto | 1.0 | | 01.01 - | G10B | 4 | 0,9 | BKR6E | 6962 | 28 | LPG 1 | 1496 |
| Alto (FF) | 1.1 | 46 | 06.02 - | K10A DOHC 16V | 4 | 0,8 | DCPR7E | 3932 | | LPG 8 | 6806 |
| Alto (HA24V) | 0.6 | | 01.05 - | K6A | 4 | | KR7AI | 7789 | | KR7AI | 7789 |
| Alto (SB308) | 0.8 | 29 | 86 - 92 | F8B | 4 | 0,9 | BPR5ES | 7422 | 6 | LPG 2 | 1497 |
| Alto (SH410) | 1.0 | 39 | 94 - 00 | G10B | 4 | 0,8 | BPR5EY | 2828 | 9 | LPG 2 | 1497 |
| Alto (SH410) | 1.0 | 53 | 94 - 12.00 | G10B | 4 | 0,8 | BPR5EY | 2828 | 9 | LPG 2 | 1497 |
| Alto (SS80) | 0.8 | 29 | 81 - 85 | F8B | 4 | 0,9 | BPR5ES | 7422 | 6 | LPG 2 | 1497 |
| Alto Lapin HE21S | 1.6 | | 01.02 - | K6A... | 4 | 0,8 | DCPR7E | 3932 | | LPG 8 | 6806 |
| Alto 600 / Turbo (SS80) | 0.6 | 22 | 06.82 - 12.85 | F5A | 4 | 0,9 | BPR5ES | 7422 | 6 | LPG 2 | 1497 |
| Baleno | 1.6 | | 95 - | G16A (16V) | 4 | 0,9 | BKR6E | 6962 | 28 | LPG 1 | 1496 |
| Baleno | 1.8 | 89 | 03.96 - 12.00 | J18A | 4 | 1,1 | BKR6E-11 | 2756 | 14 | LPG 1 | 1496 |
| Baleno | 1.8 | | 11.00 - | 16V | 4 | | IFR6J11 | 7658 | | IFR6J11 | 7658 |
| Baleno (SY413) | 1.3 | 63 | 04.95 - | G13BB | 4 | 0,9 | BKR6E | 6962 | 28 | LPG 1 | 1496 |
| Baleno (SY416) | 1.6 | 72 | 04.95 - | G16B | 4 | 0,9 | BKR6E | 6962 | 28 | LPG 1 | 1496 |
| Baleno D | 1.9 | 46 | 98 - | | 4 | █ | Y-923U | 3380 | | D-POWER 1 | 7906 |



ℓ kW



Cyl.

Order-
No.V-LINE
No.LPG/CNG
D-PowerOrder-
No.**SUZUKI**

| | | | | | | | | | | | |
|------------------------------|------|-----|--------------|-------------------------|---|-----|-----------|------|----|------------|------|
| Baleno TD | 1.9 | 55 | 98 - | | 4 | █ | Y-923U | 3380 | | D-POWER 1 | 7906 |
| Cappuccino 660 12V Turbo | 0.66 | 47 | 09.91 - | F6A DOHC Cat. | 3 | 0,8 | DCPR7EVX | 1179 | | DCPR8EIX | 6546 |
| Cappuccino 660 12V Turbo | 0.66 | 47 | 05.95 - | K6A DOHC Cat. | 3 | 0,8 | DCPR7EVX | 1179 | | DCPR8EIX | 6546 |
| Carry | 1.3 | | 06.99 - | G13BB | 4 | 0,9 | BKR6E | 6962 | 28 | LPG 1 | 1496 |
| Carry (ST90) | 0.8 | 27 | 81 - 86 | F8A | 4 | 0,9 | BPR5ES | 7422 | 6 | LPG 2 | 1497 |
| Carry (DA41T,DB41T) | 0.55 | | 05.89 -03.90 | F5B 2Valve Supercharged | | 0,9 | BPR5E | 7281 | 6 | LPG 2 | 1497 |
| Carry (DA41T/B,DB41T) | 0.55 | | 05.89 -03.90 | F5B 2Valve | | 0,9 | BPR5E | 7281 | 6 | LPG 2 | 1497 |
| Carry (DA41T/B,DB41T) | 0.55 | | 05.89 -03.90 | F5B 4Valve | | 0,8 | DCPR7E | 3932 | | LPG 8 | 6806 |
| Carry (DA51T/B,DB51T) | 0.66 | | 03.90 -09.91 | F6A 4Valve | 3 | 0,8 | DCPR7E | 3932 | | LPG 8 | 6806 |
| Carry (DA52T,DB52T) | 0.66 | | 01.99 -05.00 | F6A 2Valve Turbo | 3 | 0,9 | BPR5E | 7281 | 6 | LPG 2 | 1497 |
| Carry (DA52T,DB52T) | 0.66 | | 01.99 -09.01 | F6A 4Valve | 3 | 0,8 | DCPR7E | 3932 | | LPG 8 | 6806 |
| Carry (DA62T) | 0.66 | | 09.01 -05.02 | K6A 4Valve DOHC | 3 | 0,8 | DCPR7E | 3932 | | LPG 8 | 6806 |
| Carry (DA63T) | 0.66 | | 05.02 - | K6A 4Valve DOHC | 3 | 0,8 | DCPR7E | 3932 | | LPG 8 | 6806 |
| Carry (DA63T) | 0.66 | | 05.02 - | K6A 4Valve DOHC | 3 | | KR7AI | 7789 | | KR7AI | 7789 |
| Carry (DA71T/B,DB71T) | 0.55 | | 03.85 -05.89 | F5A 2Valve | | 0,8 | BP5ES | 6511 | 8 | LPG 2 | 1497 |
| Carry (DA71T/B,DB71T) | 0.55 | | 02.88 -05.89 | F5A 3Valve Supercharged | | 0,8 | DCP7E | 2363 | | LPG 8 | 6806 |
| Carry (DC51T,DD51T) | 0.66 | | 04.97 -01.99 | F6A 2Valve Turbo | 3 | 0,7 | PGR5A | 3987 | | PGR6A | 4984 |
| Carry (DC51T/B,DD51T) | 0.66 | | 09.91 -01.99 | F6A 4Valve | 3 | 0,8 | DCPR7E | 3932 | | LPG 8 | 6806 |
| Carry (DE51V,DF51V) | 0.66 | | 09.91 -01.99 | F6A 2Valve Turbo | 3 | 0,9 | BPR5E | 7281 | 6 | LPG 2 | 1497 |
| Carry (DE51V,DF51V) | 0.66 | | 09.91 -01.99 | F6A 4Valve | 3 | 0,8 | DCPR7E | 3932 | | LPG 8 | 6806 |
| Carry (ST30/B,ST31/V) | 0.55 | | 12.82 -03.85 | LJ50 | | 1,0 | BP5HS-10 | 7429 | | | |
| Carry (ST30V,SA81T) | 0.55 | | 05.81 -03.85 | LJ50 | | 1,0 | BP5HS-10 | 7429 | | | |
| Carry (ST40/V,ST41) | 0.55 | | 05.81 -03.85 | F5A | | 0,8 | BP5ES | 6511 | 8 | LPG 2 | 1497 |
| Carry Super (SK410) | 1.0 | 31 | 92 - 99 | F10A Cat. | 4 | 0,9 | BPR5ES | 7422 | 6 | LPG 2 | 1497 |
| Carry Super (SK410) | 1.0 | 33 | 85 - 87 | F10A | 4 | 0,9 | BPR5ES | 7422 | 6 | LPG 2 | 1497 |
| Carry Super (SK410) | 1.0 | 33 | 87 - 99 | F10A u.Cat. | 4 | 0,9 | BPR5ES | 7422 | 6 | LPG 2 | 1497 |
| Carry Van | 1.3 | | 99 - | G13BB | 4 | 0,9 | BKR6E | 6962 | 28 | LPG 1 | 1496 |
| Escudo | 1.6 | 71 | 05.00 - | G16A | 4 | 1,1 | IFR6E11 | 6741 | | IFR6E11 | 6741 |
| Escudo | 1.6 | 71 | 08.90 -11.97 | G16A | 4 | 0,9 | BKR6E | 6962 | 28 | LPG 1 | 1496 |
| Escudo | 1.6 | 71 | 12.97 -04.00 | G16A | 4 | 1,1 | BKR6E-11 | 2756 | 14 | LPG 1 | 1496 |
| Escudo | 2.0 | | 12.94 -10.96 | H20A | 4 | 0,9 | BKR6E | 6962 | 28 | LPG 1 | 1496 |
| Escudo | 2.0 | | 04.00 - | H25A | 6 | 1,1 | IFR5J11 | 7418 | | IFR5J11 | 7418 |
| Escudo | 2.0 | | 04.00 -04.05 | J20A | 4 | 1,1 | IFR5J11 | 7418 | | IFR5J11 | 7418 |
| Escudo | 2.0 | | 10.96 -11.97 | J20A | 4 | 0,9 | BKR6E | 6962 | 28 | LPG 1 | 1496 |
| Escudo | 2.0 | | 11.97 -04.00 | J20A | 4 | 1,1 | BKR6E-11 | 2756 | 14 | LPG 1 | 1496 |
| Escudo | 2.5 | | 03.98 -04.00 | H25A | 6 | 1,1 | BKR6E-11 | 2756 | 14 | LPG 1 | 1496 |
| Escudo | 2.5 | | 10.96 -11.97 | H25A | 6 | 0,9 | BKR6E | 6962 | 28 | LPG 1 | 1496 |
| Escudo (TD54W) | 2.0 | | 05.05 - | J20A | 4 | 1,1 | IFR6J11 | 7658 | | IFR6J11 | 7658 |
| Escudo (TD94W) | 2.7 | | 06.05 - | H27A | 4 | 1,1 | IFR6J11 | 7658 | | IFR6J11 | 7658 |
| Grand Vitara | 1.6 | 69 | 03.98 - | G16A / G16B | 4 | 1,1 | BKR6E-11 | 2756 | 14 | LPG 1 | 1496 |
| Grand Vitara | 2.0 | 94 | 01.98 -09.00 | J20A | 4 | 1,1 | IFR6J11 | 7658 | | IFR6J11 | 7658 |
| Grand Vitara | 2.0 | | 10.00 - | J20 | 4 | | IFR5J-11 | 7418 | | IFR6J11 | 7658 |
| Grand Vitara | 2.5 | | 10.00 - | H25 | 6 | | IFR5J-11 | 7418 | | IFR6J11 | 7658 |
| Grand Vitara (JB416) | 1.6 | 78 | 09.05 - | M16A VVT | 4 | 1,1 | IFR6J11 | 7658 | | IFR6J11 | 7658 |
| Grand Vitara (JB420) | 2.0 | 103 | 09.05 - | J20A | 4 | | IFR5J11 | 7418 | | IFR6J11 | 7658 |
| Grand Vitara (JB420) | 2.0 | 103 | 09.05 - | M20A | 4 | 1,1 | IFR5E11 | 7994 | | IFR6E11 | 6741 |
| Grand Vitara (only D) | 1.6 | 69 | 01 - | G16A / G16B | 4 | 1,1 | IFR6J11 | 7658 | | IFR6J11 | 7658 |
| Grand Vitara 2.4 (JB424) | 2.4 | 124 | 08 - | J24B | 4 | 1,1 | SILFR6A11 | 5468 | | SILFR6A11 | 5468 |
| Grand Vitara D | 2.0 | 81 | 04.01 - | HDI PSA | 4 | █ | Y-504R | 4359 | | D-POWER 24 | 1441 |
| Grand Vitara DDIS (JB419D) | 1.9 | 95 | 06 - | F9Q | 4 | █ | Y-732J | 5605 | | D-POWER 4 | 5605 |
| Grand Vitara TD XL7(JA420D) | 2.0 | 80 | 04 - | RHW | 4 | █ | Y-504R | 4359 | | D-POWER 24 | 1441 |
| Grand Vitara Tdi II (SQ420D) | 2.0 | 80 | 03.01 - | RHZ | 4 | █ | Y-504R | 4359 | | D-POWER 24 | 1441 |



ℓ kW



Cyl.

Order-
No. No.LPG/CNG
D-PowerOrder-
No.**SUZUKI**

| | | | | | | | | | | | |
|----------------------------|-----|-----|--------------|----------------|---|-----|-----------|-------|----|------------|-------|
| Grand Vitara TDiC (SQ420D) | 2.0 | 64 | 05.00 - | RF | 4 | ■ | Y-701J | 1566 | | D-POWER 39 | 1566 |
| Grand Vitara V6 | 2.7 | 127 | 09.01 - | H27A | 6 | 1,1 | IFR5J11 | 7418 | | IFR5J11 | 7418 |
| Grand Vitara V6 (SV620) | 2.5 | 125 | 01.98 - | H25A | 6 | 1,1 | BKR6E-11 | 2756 | 14 | LPG 1 | 1496 |
| Grand Vitara V6 (SV620) | 2.5 | 106 | 04.98 -09.00 | H25 | 6 | 1,1 | BKR6E-11 | 2756 | 14 | LPG 1 | 1496 |
| Grand Vitara XL7 (UBD) | 2.7 | 135 | 04.03 - | | 6 | 1,1 | IFR6J11 | 7658 | | IFR6J11 | 7658 |
| Ignis | 1.3 | 61 | 10.00 - | M13A | 4 | 1,1 | IFR6J11 | 7658 | | IFR6J11 | 7658 |
| Ignis | 1.3 | 69 | 09.03 - | M13A mit V V T | 4 | 1,1 | IFR6J11 | 7658 | | IFR6J11 | 7658 |
| Ignis | 1.5 | 73 | 09.03 - | M15A mit V V T | 4 | 1,1 | IFR6J11 | 7658 | | IFR6J11 | 7658 |
| Ignis DDiS (RM413D) | 1.3 | 51 | 09.03 - | Z13DT | 4 | ■ | Y8003J | 97256 | | D-POWER 62 | 97256 |
| Jimny | 1.3 | 63 | 10.00 - | M13A | 4 | 1,1 | IFR6J11 | 7658 | | IFR6J11 | 7658 |
| Jimny Cabrio | 1.3 | 59 | 10.98 - | G13BB | 4 | 0,9 | BKR6E | 6962 | 28 | LPG 1 | 1496 |
| Jimny DDiS (SN415D) | 1.5 | 48 | 12.03 - | K9K | 4 | ■ | Y-732J | 5605 | | D-POWER 4 | 5605 |
| Liana | 1.3 | 66 | 03.01 -01.04 | | 4 | 1,1 | BKR6E-11 | 2756 | 14 | LPG 1 | 1496 |
| Liana | 1.3 | 66 | 02.04 - | M13A | 4 | 1,1 | IFR6J11 | 7658 | | IFR6J11 | 7658 |
| Liana | 1.6 | 78 | 03.01 -01.04 | | 4 | 1,1 | BKR6E-11 | 2756 | 14 | LPG 1 | 1496 |
| Liana | 1.6 | 78 | 02.04 - | M16A | 4 | 1,1 | IFR6J11 | 7658 | | IFR6J11 | 7658 |
| Liana DDiS (RH414D) | 1.4 | 66 | 07.04 - | DV4 8HY | 4 | ■ | YE04 | 1684 | | D-POWER 40 | 1684 |
| LJ 80 | 0.8 | 29 | 80 - 83 | F8A | 4 | 0,9 | BPR5ES | 7422 | 6 | LPG 2 | 1497 |
| SA 310 | 1.0 | 37 | 84 - 85 | G10 | 4 | 0,8 | BPR6ES | 7822 | 2 | LPG 2 | 1497 |
| Samurai | 1.0 | 33 | 90 - | F10A | 4 | 0,9 | BPR5ES | 7422 | 6 | LPG 2 | 1497 |
| Samurai | 1.3 | 44 | 88 - 90 | G13A u.Cat. | 4 | 0,9 | BPR5ES | 7422 | 6 | LPG 2 | 1497 |
| Samurai | 1.3 | 47 | 88 - 89 | G13A | 4 | 0,9 | BPR5ES | 7422 | 6 | LPG 2 | 1497 |
| Samurai | 1.3 | 51 | 92 - | G13BA | 4 | 0,9 | BPR5ES | 7422 | 6 | LPG 2 | 1497 |
| Samurai (SJ413) | 1.3 | 51 | 90 - | G13BA Cat. | 4 | 0,9 | BPR5ES | 7422 | 6 | LPG 2 | 1497 |
| Samurai Pick-up | 1.3 | 51 | 10.99 -10.00 | G13BA | 4 | 0,9 | BPR5ES | 7422 | 6 | LPG 2 | 1497 |
| Samurai TD | 1.9 | 46 | 09.98 - | XUD9 | 4 | ■ | Y-923U | 3380 | | D-POWER 1 | 7906 |
| SJ 410 | 1.0 | 33 | 82 - 85 | F10A | 4 | 0,9 | BPR5ES | 7422 | 6 | LPG 2 | 1497 |
| SJ 413 | 1.3 | 44 | 87 - 88 | G13A u.Cat. | 4 | 0,9 | BPR5ES | 7422 | 6 | LPG 2 | 1497 |
| SJ 413 | 1.3 | 47 | 85 - 88 | G13A | 4 | 0,8 | BPR6ES | 7822 | 2 | LPG 2 | 1497 |
| SK 410 Super Carry | 1.0 | 31 | 85 - | F10A | 4 | 0,9 | BPR5ES | 7422 | 6 | LPG 2 | 1497 |
| Splash 1.0 (A5B310) | 1.0 | 48 | 08 - | K10B | 3 | 1,1 | IKR6G11 | 7980 | | IKR6G11 | 7980 |
| Splash 1.2 (A5B412) | 1.2 | 63 | 08 - | K12B | 4 | 1,1 | IKR6G11 | 7980 | | IKR6G11 | 7980 |
| Splash 1.3 DDiS (A5B413D) | 1.3 | 55 | 08 - | D13A | 4 | ■ | Y8003J | 97256 | | D-POWER 62 | 97256 |
| ST 90 Carry | 0.8 | 27 | 81 - 86 | F8A | 4 | 0,9 | BPR5ES | 7422 | 6 | LPG 2 | 1497 |
| Swift | 1.6 | | 95 - | | 4 | 1,1 | BPR6ES-11 | 4824 | 13 | LPG 2 | 1497 |
| Swift (C11S)(RS413) | 1.3 | 68 | 05.05 - | M13A | 4 | 1,1 | IFR6J11 | 7658 | | IFR6J11 | 7658 |
| Swift (C21S)(RS415) | 1.5 | 75 | 05.05 - | M15A VVT | 4 | 1,1 | IFR6J11 | 7658 | | IFR6J11 | 7658 |
| Swift (C91S)(RS413D) | 1.3 | 52 | 09.05 - | Z13DT | 4 | ■ | Y8003J | 97256 | | D-POWER 62 | 97256 |
| Swift (SA310) | 1.0 | 37 | 84 - 85 | G10 | 4 | 0,8 | BPR6ES | 7822 | 2 | LPG 2 | 1497 |
| Swift (SA413) | 1.3 | 47 | 86 - 89 | G13A u.Cat. | 4 | 0,8 | BPR6ES | 7822 | 2 | LPG 2 | 1497 |
| Swift (SA413) | 1.3 | 50 | 84 - 89 | G13A | 4 | 0,8 | BPR6ES | 7822 | 2 | LPG 2 | 1497 |
| Swift (SA413) | 1.3 | 54 | 84 - 86 | G13A | 4 | 0,8 | BPR6ES | 7822 | 2 | LPG 2 | 1497 |
| Swift (SA413) | 1.3 | 74 | 86 - | G13B | 4 | 0,8 | BPR6ES | 7822 | 2 | LPG 2 | 1497 |
| Swift (SF310) | 1.0 | 37 | 89 - 90 | G10A u.Cat. | 3 | 0,8 | BPR6ES | 7822 | 2 | LPG 2 | 1497 |
| Swift (SF310) | 1.0 | 40 | 89 - 92 | G10A Cat. | 3 | 0,8 | BPR6ES | 7822 | 2 | LPG 2 | 1497 |
| Swift (SF310) | 1.3 | 50 | 89 - 92 | G13BA u.Cat. | 4 | 0,8 | BPR6ES | 7822 | 2 | LPG 2 | 1497 |
| Swift (SF310)Typ1+2 | 1.0 | 39 | 92 - | G10A SOHC Cat. | 3 | 0,8 | BPR6ES | 7822 | 2 | LPG 2 | 1497 |
| Swift (SF413) | 1.3 | 50 | 92 - | G13BA Cat. | 4 | 0,8 | BPR6ES | 7822 | 2 | LPG 2 | 1497 |
| Swift (SF413) | 1.3 | 52 | 89 - 92 | G13BA Cat. | 4 | 0,8 | BPR6ES | 7822 | 2 | LPG 2 | 1497 |
| Swift (SF413) | 1.3 | | | G13 | 4 | 0,8 | BPR6ES | 7822 | 2 | LPG 2 | 1497 |
| Swift (SF413)Typ1+2 | 1.3 | 74 | 89 - | G13B OHC Cat. | 4 | 0,8 | BPR6ES | 7822 | 2 | LPG 2 | 1497 |
| Swift (SF416) | 1.6 | 70 | 89 - 92 | G16B Cat. | 4 | 0,9 | BKR6E | 6962 | 28 | LPG 1 | 1496 |



ℓ kW

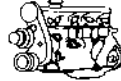

Cyl.

Order-
No. No.LPG/CNG
D-PowerOrder-
No.**SUZUKI**

| | | | | | | | | | | | |
|------------------------|------|-----|---------------|------------------|---|-----|-----------|-------|----|------------|-------|
| Swift (SF416)Typ1+2 | 1.6 | 68 | 92 - | G16B OHC Cat. | 4 | 0,9 | BKR6E | 6962 | 28 | LPG 1 | 1496 |
| Swift (ZC31S) | 1.6 | | 09.05 - | M16A | 4 | 1,1 | IFR6J11 | 7658 | | IFR6J11 | 7658 |
| Swift Sport (RS416) | 1.6 | 92 | 01.07 - | M16A VT | 4 | 1,1 | IFR6J11 | 7658 | | IFR6J11 | 7658 |
| Swift DDIS (RS413D) | 1.3 | 52 | 01.08 - | D13A | 4 | █ | Y8003J | 97256 | | D-POWER 62 | 97256 |
| SX 306 Cappuccino | 0.65 | 47 | 94 - | F6A | | 0,8 | DCPR7EVX | 1179 | | DCPR8EIX | 6546 |
| SX4 (RW416) | 1.5 | 73 | 06 - | M15A | 4 | 1,1 | IFR6J11 | 7658 | | IFR6J11 | 7658 |
| SX4 (RW416) | 1.6 | 79 | 06 - | M16A VT | 4 | 1,1 | IFR6J11 | 7658 | | IFR6J11 | 7658 |
| SX4 (RW419D) | 1.9 | 88 | 06.06 - | D19AA | 4 | █ | Y-534J | 3413 | | D-POWER 36 | 3413 |
| SX4 (YB11S / XC11S) | 1.5 | 73 | 08 - | M15A | 4 | 1,1 | IFR6J11 | 7658 | | IFR6J11 | 7658 |
| Vitara | 1.6 | 59 | 91 - 98 | G16B Cat. | 4 | 0,8 | BPR6ES | 7822 | 2 | LPG 2 | 1497 |
| Vitara | 1.6 | 60 | 91 - 98 | G16A | 4 | 0,9 | BPR5ES | 7422 | 6 | LPG 2 | 1497 |
| Vitara | 1.6 | 70 | 09.93 - 98 | G16B | 4 | 0,9 | BKR6E | 6962 | 28 | LPG 1 | 1496 |
| Vitara | 1.6 | | 10.00 - | G16A | 4 | 1,1 | IFR6E11 | 6741 | | IFR6E11 | 6741 |
| Vitara | 2.0 | | | J20A | 6 | 0,9 | BKR6E | 6962 | 28 | LPG 1 | 1496 |
| Vitara (SE416) Typ 1 | 1.6 | 60 | 88 - 98 | G16A SOHC Cat. | 4 | 0,9 | BPR5ES | 7422 | 6 | LPG 2 | 1497 |
| Vitara (SE416) Typ 2 | 1.6 | 59 | - 98 | G16A SOHC | 4 | 0,9 | BPR5ES | 7422 | 6 | LPG 2 | 1497 |
| Vitara (SV620) | 2.0 | 100 | 06.95 - | H20A | 6 | 0,9 | BKR6E | 6962 | 28 | LPG 1 | 1496 |
| Vitara 16V | 1.6 | 71 | 04.95 - 98 | G16A | 4 | 0,9 | BKR6E | 6962 | 28 | LPG 1 | 1496 |
| Vitara D | 2.0 | 52 | 12.94 - 03.98 | RFL-4 | 4 | █ | Y-701J | 1566 | | D-POWER 39 | 1566 |
| Vitara Long | 1.6 | 71 | 91 - 98 | G16B SOHC Cat. | 4 | 0,9 | BKR6E | 6962 | 28 | LPG 1 | 1496 |
| Vitara TD | 1.9 | 50 | 04.96 - 03.98 | XUD9A | 4 | █ | Y-938R | 5267 | | D-POWER 1 | 7906 |
| Vitara TD | 1.9 | 55 | 97 - 98 | | 4 | █ | Y-923U | 3380 | | D-POWER 1 | 7906 |
| Vitara TD | 1.9 | 66 | 05.00 - | XUD... PSA Group | 4 | █ | Y-923U | 3380 | | D-POWER 1 | 7906 |
| Vitara V6 (SV620) | 2.5 | 125 | 05.98 - | H25A | 6 | 1,1 | BKR6E-11 | 2756 | 14 | LPG 1 | 1496 |
| Wagon R GL | 1.3 | 56 | 04.00 - | G13BB | 4 | 1,1 | BKR6E-11 | 2756 | 14 | LPG 1 | 1496 |
| Wagon R+ | 1.0 | 55 | 02.04 - | G10 | 4 | 1,1 | BPR6ES-11 | 4824 | 13 | LPG 2 | 1497 |
| Wagon R+ | 1.2 | 51 | 98 - | K12A | 4 | 0,8 | DCPR7E | 3932 | | LPG 8 | 6806 |
| Wagon R+ | 1.3 | 68 | 02.04 - | M13A mit VT | 4 | 1,1 | IFR6J11 | 7658 | | IFR6J11 | 7658 |
| Wagon R+ | 1.3 | 69 | | G13BB | 4 | 1,1 | BKR6E-11 | 2756 | 14 | LPG 1 | 1496 |
| Wagon R+ (SR410) | 1.0 | 48 | 97 - | K10A | 4 | 0,8 | DCPR7E | 3932 | | LPG 8 | 6806 |
| Wagon R+ 12V | 1.0 | 44 | 03.05 - | Z10XEP | 3 | 1,1 | ZFR5F-11 | 2262 | | LPG 6 | 1565 |
| Wagon R+ 16V | 1.2 | 59 | 03.05 - | Z12XEP | 4 | 1,1 | ZFR5F-11 | 2262 | | LPG 6 | 1565 |
| Wagon R+ DDiS (RB413D) | 1.3 | 51 | 09.03 - | Z13DT | 4 | █ | Y8003J | 97256 | | D-POWER 62 | 97256 |
| X-90 | 1.6 | 71 | 10.95 - | G16A | 4 | 0,9 | BKR6E | 6962 | 28 | LPG 1 | 1496 |
| X-90 | 1.6 | 71 | 03.96 - | G16B/G16W | 4 | 0,9 | BKR6E | 6962 | 28 | LPG 1 | 1496 |

TALBOT

| | | | | | | | | | | | |
|----------------------|-----|----|---------------|-----------|---|-----|--------|------|---|-----------|------|
| Express D | 1.9 | 51 | 11.87 - | XUD 9 A | 4 | █ | Y-924J | 7906 | | D-POWER 1 | 7906 |
| Express D | 2.5 | 55 | 09.81 - 10.93 | CRD 93 | 4 | █ | Y-208T | 1250 | | | |
| Express TD | 2.5 | 70 | 09.81 - 10.93 | CRD 93 LS | 4 | █ | Y-208T | 1250 | | | |
| Horizon alle Modelle | | | -06.86 | | 4 | | BP6ES | 7811 | 4 | LPG 2 | 1497 |
| Horizon D | 1.9 | 47 | 07.82 - 06.86 | XUD9 | 4 | █ | Y-924J | 7906 | | D-POWER 1 | 7906 |
| Horizon D | 1.9 | 51 | 11.87 - | XUD9A | 4 | █ | Y-924J | 7906 | | D-POWER 1 | 7906 |
| Samba 1,0 | 1.0 | 33 | 01.81 - 12.85 | XV5 | 4 | 0,8 | BP6EFS | 3812 | 5 | LPG 5 | 1516 |
| Samba 1,0 | 1.0 | 33 | 06.83 - 12.87 | XV8 | 4 | 0,8 | BP6EFS | 3812 | 5 | LPG 5 | 1516 |
| Samba 1,1 | 1.1 | 31 | 01.81 - 12.87 | XW7 | 4 | 0,8 | BP6EFS | 3812 | 5 | LPG 5 | 1516 |
| Samba 1,1 | 1.1 | 42 | 01.81 - 12.87 | XW7 | 4 | 0,8 | BP6EFS | 3812 | 5 | LPG 5 | 1516 |
| Samba 1,2 Rallye | 1.2 | 65 | 06.82 - 12.87 | XZ7R | 4 | 0,8 | BP6EFS | 3812 | 5 | LPG 5 | 1516 |
| Samba 1,4 | 1.4 | 52 | 05.81 - 12.87 | XY6B | 4 | 0,8 | BP6EFS | 3812 | 5 | LPG 5 | 1516 |
| Samba 1,4 | 1.4 | 55 | 06.83 - 12.87 | XY7 | 4 | 0,8 | BP6EFS | 3812 | 5 | LPG 5 | 1516 |
| Samba 1,4 | 1.4 | 57 | 01.81 - 12.87 | XY8 | 4 | 0,8 | BP6EFS | 3812 | 5 | LPG 5 | 1516 |
| Samba 1,4 | 1.4 | 58 | 05.81 - 12.87 | XY6B | 4 | 0,8 | BP6EFS | 3812 | 5 | LPG 5 | 1516 |



l kW

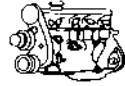

Cyl.

Order-
No. No.LPG/CNG
D-PowerOrder-
No.**TALBOT**

| | | | | | | | | | | | |
|------------------------|-----|----|---------------|------|---|-----|--------|------|---|-----------|------|
| Samba 1,4 | 1.4 | 60 | 06.83 - 12.87 | XY7 | 4 | 0,8 | BP6EFS | 3812 | 5 | LPG 5 | 1516 |
| Solara LS, GL, GLS, SX | 1.6 | 51 | 07.82 - 04.84 | J1B | 4 | 0,7 | BP6ES | 7811 | 4 | LPG 2 | 1497 |
| Tagora GL, GLS 2.2 | 2.2 | | | | 4 | 0,7 | BP6ES | 7811 | 4 | LPG 2 | 1497 |
| Tagora SX 2.6 | 2.6 | | | | 6 | 0,8 | BP6EFS | 3812 | 5 | LPG 5 | 1516 |
| Tagora TD | 2.3 | 59 | 09.81 - 06.83 | XD2S | 4 | █ | Y-924J | 7906 | | D-POWER 1 | 7906 |

TATRA

| | | | | | | | | | | | |
|-------|-----|-----|---------------|--|---|-----|--------|------|----|-------|------|
| 613-3 | 3.5 | 123 | 01.84 - 03.94 | | 6 | 0,7 | BCP6ES | 4930 | 17 | LPG 3 | 1498 |
| 613-4 | 3.5 | 124 | 93 - | | 8 | 0,9 | BKR6E | 6962 | 28 | LPG 1 | 1496 |

TOFAS

| | | | | | | | | | | | |
|---------------------|-----|----|---------------|--|---|-----|--------|------|---|-------|------|
| 124 Serce | 1.3 | 48 | 09.83 - | | 4 | 0,7 | BP6ES | 7811 | 4 | LPG 2 | 1497 |
| 131 Dogan | 1.6 | 55 | 03.81 - | | 4 | 0,7 | BP6ES | 7811 | 4 | LPG 2 | 1497 |
| 131 Dogan S/SX/SLX | 1.6 | 55 | 06.92 - | | 4 | 0,8 | BPR6ES | 7822 | 2 | LPG 2 | 1497 |
| 131 Kartal L | 1.6 | 55 | 03.81 - 06.92 | | 4 | 0,7 | BP6ES | 7811 | 4 | LPG 2 | 1497 |
| 131 Kartal SL / SLX | 1.6 | 55 | 06.92 - | | 4 | 0,8 | BPR6ES | 7822 | 2 | LPG 2 | 1497 |
| Sahin | 1.3 | 47 | 02.81 - 06.82 | | 4 | 0,7 | BP6ES | 7811 | 4 | LPG 2 | 1497 |
| Sahin | 1.6 | 55 | 02.82 - | | 4 | 0,7 | BP6ES | 7811 | 4 | LPG 2 | 1497 |
| Tempra | 1.6 | 63 | 11.90 - | | 4 | 0,8 | BPR6ES | 7822 | 2 | LPG 2 | 1497 |
| Tempra i.e. | 2.0 | 88 | 07.92 - | | 4 | 0,8 | BPR6ES | 7822 | 2 | LPG 2 | 1497 |

TOFAS / FIAT

| | | | | | | | | | | | |
|------------------------|-----|--|---------------|---------|---|-----|----------|------|----|-------|------|
| Brava 16V | 1.2 | | 11.98 - 09.01 | 16V | 4 | 0,9 | DCPR8E-N | 5692 | | LPG 8 | 6806 |
| Brava 1.4 12V | 1.4 | | 10.95 - 10.98 | 12V | 4 | | BKR6EKC | 2848 | 26 | LPG 1 | 1496 |
| Bravo 16V | 1.2 | | 11.98 - 09.01 | 16V | 4 | 0,9 | DCPR8E-N | 5692 | | LPG 8 | 6806 |
| Bravo 1.4 12V | 1.4 | | 10.95 - 10.98 | 12V | 4 | | BKR6EKC | 2848 | 26 | LPG 1 | 1496 |
| Doblo 16V | 1.3 | | 11.01 - | MPI 16V | 4 | 0,9 | DCPR8E-N | 5692 | | LPG 8 | 6806 |
| Marea 1.4 12V | 1.4 | | 10.96 - 02.99 | 12V | 4 | | BKR6EKC | 2848 | 26 | LPG 1 | 1496 |
| Marea 2.0 20V | 2.0 | | 10.96 - 02.99 | 20V | 4 | | BKR6EKC | 2848 | 26 | LPG 1 | 1496 |
| Palio 16V | 1.3 | | 03.00 - | MPI 16V | 4 | 0,9 | DCPR8E-N | 5692 | | LPG 8 | 6806 |
| Palio 1.2 i.e. | 1.2 | | 10.01 - | 16V | 4 | 0,9 | DCPR8E-N | 5692 | | LPG 8 | 6806 |
| Palio 1.4 i.e. | 1.4 | | 03.98 - 09.01 | | 4 | | BKR5EK | 7956 | 23 | LPG 1 | 1496 |
| Palio Weekend 16V | 1.3 | | 03.00 - | MPI 16V | 4 | 0,9 | DCPR8E-N | 5692 | | LPG 8 | 6806 |
| Palio Weekend 1.2 i.e. | 1.2 | | 10.01 - | 16V | 4 | 0,9 | DCPR8E-N | 5692 | | LPG 8 | 6806 |
| Palio Weekend 1.4 i.e. | 1.4 | | 09.98 - 06.01 | | 4 | | BKR5EK | 7956 | 23 | LPG 1 | 1496 |
| Siena 16V | 1.3 | | 03.00 - | MPI 16V | 4 | 0,9 | DCPR8E-N | 5692 | | LPG 8 | 6806 |
| Siena 1.4 i.e. | 1.4 | | 05.98 - 06.01 | | 4 | | BKR5EK | 7956 | 23 | LPG 1 | 1496 |
| Stilo 16V | 1.2 | | 10.01 - | 16V | 4 | 0,9 | DCPR8E-N | 5692 | | LPG 8 | 6806 |
| Stilo 1.6 16V | 1.6 | | 10.01 - | 16V | 4 | 0,9 | BKR5EZ | 7642 | 36 | LPG 1 | 1496 |
| Stilo 1.8 16V | 1.8 | | 10.01 - | 16V | 4 | 0,9 | BKR6EZ | 4619 | 38 | LPG 1 | 1496 |
| Stilo S.W. 1.6 16V | 1.6 | | 01.03 - | 16V | 4 | 0,9 | BKR5EZ | 7642 | 36 | LPG 1 | 1496 |
| Stilo S.W. 1.8 16V | 1.8 | | 01.03 - | 16V | 4 | 0,9 | BKR6EZ | 4619 | 38 | LPG 1 | 1496 |

TOYOTA

| | | | | | | | | | | | |
|----------------------------------|-----|-----|------------|---------------|---|-----|------------|------|---|-------|------|
| 4 Runner | 2.4 | 82 | 89 - 95 | 22R/22RE Cat. | 4 | 0,8 | BPR5EY | 2828 | 9 | LPG 2 | 1497 |
| 4 Runner | 2.8 | | | 2L | 4 | █ | Y-168R | 2162 | | | |
| 4 Runner | 2.8 | | 93 - 96 | 3L | 4 | █ | Y-715R | 5376 | | | |
| 4 Runner | 3.0 | 105 | 89 - 96 | 3VZ-E Cat. | 6 | 0,8 | BKR5EYA | 2087 | | LPG 1 | 1496 |
| 4 Runner (RZN180,185,VZN180 185) | 2.7 | | 01.00 - | 3RZ-FE | 6 | 0,8 | BKR5EYA | 2087 | | LPG 1 | 1496 |
| 4 Runner (RZN180,185,VZN180,185) | 3.4 | | 01.00 - | 5VZ-FE | 6 | | BKR5EKB-11 | 3967 | | | |
| 4 Runner (RZN185) | 2.7 | 112 | 98 - 12.99 | 3RZ-FE | 6 | 0,8 | BKR5EYA | 2087 | | LPG 1 | 1496 |
| 4 Runner (RZN185) | 3.4 | 136 | 98 - 12.99 | 5VZ-FE | 6 | | BKR5EKB-11 | 3967 | | | |



ℓ kW

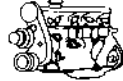

Cyl.

Order-
No.V-LINE
No.LPG/CNG
D-PowerOrder-
No.**TOYOTA**

| | | | | | | | | | | | |
|--|------|-----|-------------|----------------------|---|-----|------------|------|----|------------|------|
| 4 Runner (VZN185) | 2.7 | 112 | 98-12.99 | 3RZ-FE | 6 | 0,8 | BKR5EYA | 2087 | | LPG 1 | 1496 |
| 4 Runner (VZN185) | 3.4 | 136 | 98-12.99 | 5VZ-FE | 6 | | BKR5EKB-11 | 3967 | | | |
| 4 Runner (GRN210,215) | 4.0 | | 01.04- | 1GR-FE | 6 | 1,1 | LFR6C-11 | 5788 | | | |
| 4 Runner D | 2.4 | | | 2L | 4 | ■ | Y-118R | 2187 | | | |
| 4 Runner D | 2.5 | | 01.93- | 2L-T | 4 | ■ | Y-715R | 5376 | | | |
| 4 Runner D | 2.8 | | 01.93- 96 | 3L | 4 | ■ | Y-715R | 5376 | | | |
| 4 Runner TD | 2.4 | | 01.90-12.96 | 2L-T | 4 | ■ | Y-715R | 5376 | | | |
| Auris 1.33 VVT-i (NRE150) | 1.33 | 74 | 11.08-01.10 | 1NR-FE | 4 | 1,1 | ILKAR7B11 | 4912 | | ILKAR7B11 | 4912 |
| Auris 1.4 D-4D (ADE150,157)(NDE150,151) | 1.4 | 66 | 03.07- | 1ND-TV | 4 | ■ | Y-542J | 5513 | | D-POWER 45 | 5513 |
| Auris 1.4 VVT-i (ZRE151) | 1.4 | 71 | 10.06- | 4ZZ-FE | 4 | 1,1 | BKR5EYA-11 | 2526 | 39 | LPG 1 | 1496 |
| Auris 1.6 (ZRE151) | 1.6 | 97 | 12.08- | 1ZR-FAE | 4 | 1,1 | ILKAR7B11 | 4912 | | ILKAR7B11 | 4912 |
| Auris 1.6 VVT-i (ZRE151) | 1.6 | 91 | 10.06- | 1ZR-FE | 4 | 1,1 | ILKAR7B11 | 4912 | | ILKAR7B11 | 4912 |
| Auris 1.8 (ZRE152H) | 1.8 | 108 | 10.09- | 2ZR-FAE | 4 | 1,1 | ILKAR7B11 | 4912 | | ILKAR7B11 | 4912 |
| Auris 1.8 (ZZE150)(ZRE151,152) | 1.8 | 100 | 10.06- | 2ZR-FE | 4 | 1,1 | ILKAR7B11 | 4912 | | ILKAR7B11 | 4912 |
| Avalon (MCX20) | 3.0 | | 01.01-12.01 | 1MZ-FE | 6 | | BKR6EKB-11 | 3583 | | | |
| Avalon (MCX20) | 3.0 | | 01.02- | 1MZ-FE | 6 | | BKR6EKP-11 | 3452 | | | |
| Avensis (1AZ-FE) | 2.0 | | 01.03- | 1AZ-FE with 3way cat | 4 | 1,1 | IFR6T11 | 4589 | | IFR6T11 | 4589 |
| Avensis (1AZ-FE) | 2.0 | | 01.03- | 1AZ-FE without cat | 4 | 1,1 | BKR6EYA-11 | 4073 | | LPG 1 | 1496 |
| Avensis (AT220,221,ST220) | 1.6 | 81 | 04.98- | 4A-FE | 4 | 1,1 | BKR6EYA-11 | 4073 | | LPG 1 | 1496 |
| Avensis (AT220,221,ST220) | 1.8 | 81 | 01.98- | 7A-FE | 4 | 1,3 | BKR6EP-13 | 2550 | | | |
| Avensis (AZT220) | 1.6 | | 01.02- | 3ZZ-FE | 4 | 1,1 | BKR5EYA-11 | 2526 | 39 | LPG 1 | 1496 |
| Avensis (AZT220) | 1.8 | | 01.02- | 1ZZ-FE | 4 | 1,1 | BKR5EYA-11 | 2526 | 39 | LPG 1 | 1496 |
| Avensis (AZT220) | 2.0 | | 01.02- | 3S-FE | 4 | | BKR6EKB-11 | 3583 | | | |
| Avensis (AZT250 / W) | 2.0 | | 09.03- | 1AZ-FSE | 4 | 1,1 | HB6BIX-11P | 5705 | | HB6BIX-11P | 5705 |
| Avensis (CT220) | 2.0 | 66 | 01.98- | 2C-T | 4 | ■ | Y-532J | 7782 | | | |
| Avensis (CT220) | 2.0 | 66 | 01.98- | 2C-TE | 4 | ■ | Y-532J | 7782 | | | |
| Avensis (ST220) | 1.6 | | 01.02- | 3ZZ-FE | 4 | 1,1 | BKR5EYA-11 | 2526 | 39 | LPG 1 | 1496 |
| Avensis (ST220) | 1.8 | 95 | 01.02- | 1ZZ-FE | 4 | 1,1 | BKR5EYA-11 | 2526 | 39 | LPG 1 | 1496 |
| Avensis (ST220) | 2.0 | | 01.02- | 3S-FE | 4 | | BKR6EKB-11 | 3583 | | | |
| Avensis (ZZT220, 221) | 1.6 | | 01.02- | 3ZZ-FE | 4 | 1,1 | BKR5EYA-11 | 2526 | 39 | LPG 1 | 1496 |
| Avensis (ZZT220, 221) | 1.8 | 95 | 01.02- | 1ZZ-FE | 4 | 1,1 | BKR5EYA-11 | 2526 | 39 | LPG 1 | 1496 |
| Avensis (ZZT220, 221) | 2.0 | | 01.02- | 3S-FE | 4 | | BKR6EKB-11 | 3583 | | | |
| Avensis (ZZT250,251)(AZT250) | 1.8 | | 09.03- | 1ZZ-FE | 4 | 1,1 | BKR5EYA-11 | 2526 | 39 | LPG 1 | 1496 |
| Avensis (AT220,221,ST220) | 2.0 | 94 | 01.98- | 3S-FE | 4 | | BKR6EKP-11 | 3452 | | | |
| Avensis (AZT251 / W) | 2.4 | 120 | 09.05- | 2AZ-FSE | 4 | 1,1 | HB6BIX-11P | 5705 | | | |
| Avensis (ZZT250,251)(AZT250) | 1.6 | | 09.03- | 3ZZ-FE | 4 | 1,1 | BKR5EYA-11 | 2526 | 39 | LPG 1 | 1496 |
| Avensis 3 (ZRT270) | 1.6 | 81 | 04.08- | 1ZRFAE | 4 | 1,1 | ILKAR7B11 | 4912 | | ILKAR7B11 | 4912 |
| Avensis 3 (ZRT270) | 1.6 | 97 | 11.08- | 1ZRFAE | 4 | 1,1 | ILKAR7B11 | 4912 | | ILKAR7B11 | 4912 |
| Avensis 3 (ZRT271) | 1.8 | 108 | 11.08- | 2ZRFAE | 4 | 1,1 | ILKAR7B11 | 4912 | | ILKAR7B11 | 4912 |
| Avensis 3 (ZRT272) | 2.0 | 112 | 11.08- | 3ZRFAE | 4 | 1,1 | ILKAR7B11 | 4912 | | ILKAR7B11 | 4912 |
| Avensis II (ZZT250;251)(AZT250) | 1.6 | 81 | 03.03- 09 | 3ZZ-FE | 4 | 1,1 | BKR5EYA-11 | 2526 | 39 | LPG 1 | 1496 |
| Avensis II (ZZT250;251)(AZT250) | 1.8 | 95 | 03.03- 09 | 1ZZ-FE | 4 | 1,1 | BKR5EYA-11 | 2526 | 39 | LPG 1 | 1496 |
| Avensis II (ATZ250) | 2.0 | 110 | 01.03- 09 | 1AZ-FE V V T-i | 4 | 1,1 | IFR6T11 | 4589 | | IFR6T11 | 4589 |
| Avensis II (CDT250) D- Cat | 2.0 | 85 | 03.03- 09 | 1CD-FTV | 4 | ■ | Y-531J | 5467 | | D-POWER 44 | 5467 |
| Avensis Verso (ACM20) | 2.0 | 110 | 05.01- | 1AZ-FE | 4 | 1,1 | IFR6T11 | 4589 | | IFR6T11 | 4589 |
| Avensis Verso (ACM20) | 2.4 | | 01.04- | 2AZ-FE | 4 | 1,1 | BKR6EYA-11 | 4073 | | LPG 1 | 1496 |
| Aygo | 1.0 | 50 | 05.05- | 1KR-FE | 3 | 1,1 | LFR6C-11 | 5788 | | | |
| Aygo | 1.4 | 52 | 06.05- | | 4 | ■ | YE05 | 5207 | | | |
| Camry | 1.8 | 66 | - 85 | 1S | 4 | 0,8 | BPR5EY | 2828 | 9 | LPG 2 | 1497 |
| Camry | 2.0 | 62 | 90- 91 | 2C-T | 4 | ■ | Y-703R | 3782 | | | |
| Camry | 2.0 | 73 | 86- 86 | 2S-E | 4 | 1,1 | BPR5EY-11 | 3028 | | LPG 2 | 1497 |



ℓ kW



Cyl.

Order-
No. No.LPG/CNG
D-PowerOrder-
No.**TOYOTA**

| | | | | | | | | | | | |
|-----------------------------|-----|-----|---------------|-------------------------|---|-----|-------------|------|---|---------|------|
| Camry | 2.0 | 73 | - 85 | 2S-EC | 4 | 0,8 | BPR5EY | 2828 | 9 | LPG 2 | 1497 |
| Camry | 2.0 | | - 92 | 1-CT | 4 | █ | Y-146R | 7492 | | | |
| Camry (SV20,21,25) | 1.8 | 66 | 87 - 87 | 1S-I | 4 | 1,1 | BRE527Y-11 | 6029 | | | |
| Camry (SV20,21,25) | 1.8 | 66 | - 87 | 1S-L | 4 | 0,8 | BPR5EY | 2828 | 9 | LPG 2 | 1497 |
| Camry (ACV30,31) | 2.0 | | 08.01 - | 1AZ-FE | 4 | 1,1 | IFR6T11 | 4589 | | IFR6T11 | 4589 |
| Camry (ACV30,31) | 2.4 | 112 | 08.01 - | 2AZ-FE | 6 | 1,1 | IFR6T11 | 4589 | | IFR6T11 | 4589 |
| Camry (ACV30,31) | 3.0 | | 08.01 - | 1MZ-FE | 6 | 1,1 | IFR6T11 | 4589 | | IFR6T11 | 4589 |
| Camry (MCV20) | 2.2 | | 98 - 12.99 | 5S-FE | 4 | | BKR6EKP-11 | 3452 | | | |
| Camry (MCV30) | 2.0 | | 08.01 - | 1AZ-FE | 4 | 1,1 | IFR6T11 | 4589 | | IFR6T11 | 4589 |
| Camry (MCV30) | 2.4 | 112 | 08.01 - | 2AZ-FE | 6 | 1,1 | IFR6T11 | 4589 | | IFR6T11 | 4589 |
| Camry (MCV30) | 3.0 | | 08.01 - | 1MZ-FE | 6 | 1,1 | IFR6T11 | 4589 | | IFR6T11 | 4589 |
| Camry (SV20,21,25,VZV21) | 2.0 | 89 | 86 - | 3S-FE Cat. | 4 | 1,1 | BCPR6EY-11 | 3720 | | LPG 3 | 1498 |
| Camry (SV20,21,25,VZV21) | 2.0 | 94 | 87 - | 3S-FE | 4 | 1,1 | BCPR6EY-11 | 3720 | | LPG 3 | 1498 |
| Camry (SV21,25,VZV21) | 2.5 | 118 | 88 - 92 | 2VZ-FE Cat. | 6 | 1,1 | BCPR6EP-11 | 3350 | | LPG 3 | 1498 |
| Camry (SVX20) | 2.2 | | 98 - 12.99 | 5S-FE | 4 | | BKR6EKP-11 | 3452 | | | |
| Camry (SVX20, MCV20) | 2.2 | | 01.00 - | 5S-FE | 4 | | BKR6EKB-11 | 3583 | | | |
| Camry (SVX20, MCV20) | 3.0 | 137 | 01.00 - | 1MZ-FE V6 | 6 | | BKR6EKP-11 | 3452 | | | |
| Camry (SXX10,VCV10) | 2.2 | 100 | 92 - | 5S-FE | 4 | 1,1 | BKR6EYA-11 | 4073 | | LPG 1 | 1496 |
| Camry (SXX10,VCV10) | 3.0 | 138 | 92 - | 3VZ-FE | 6 | 1,1 | BCPR6EP-11 | 3350 | | LPG 3 | 1498 |
| Camry MCV20 | 2.2 | 100 | 08.96 - 12.99 | 5S-FE with 3way cat | 4 | | BKR6EKP-11 | 3452 | | | |
| Camry MCV20 | 2.2 | 100 | 08.96 - 12.99 | 5S-FE without 3way cat | 4 | | BKR6EKB-11 | 3583 | | | |
| Camry MCV20 | 3.0 | 138 | 08.96 - 12.99 | 1MZ-FE with 3way cat | 6 | | BKR6EKP-11 | 3452 | | | |
| Camry MCV20 | 3.0 | 138 | 08.96 - 12.99 | 1MZ-FE without 3way cat | 6 | | BKR6EKB-11 | 3583 | | | |
| Camry SXV20 | 2.2 | 100 | 08.96 - 12.99 | 5S-FE with 3way cat | 4 | | BKR6EKP-11 | 3452 | | | |
| Camry SXV20 | 2.2 | 100 | 08.96 - 12.99 | 5S-FE without 3way cat | 4 | | BKR6EKB-11 | 3583 | | | |
| Camry SXV20 | 3.0 | 138 | 08.96 - 12.99 | 1MZ-FE with 3way cat | 6 | | BKR6EKP-11 | 3452 | | | |
| Camry SXV20 | 3.0 | 138 | 08.96 - 12.99 | 1MZ-FE without 3way cat | 6 | | BKR6EKB-11 | 3583 | | | |
| Carina E | 1.8 | 48 | 04.82 - 09.83 | 1C | 4 | █ | Y-146R | 7492 | | | |
| Carina E | 2.0 | | 02.92 - | 2C | 4 | █ | Y-703R | 3782 | | | |
| Carina E (DK) | 1.6 | | 92 - | 4A-FE Cat. | 4 | 0,8 | BKR6EYA | 2249 | | LPG 1 | 1496 |
| Carina E (DK) | 1.6 | | 92 - | 4A-FE Cat. Lean Burn | 4 | 1,3 | BKR6EP-13 | 2550 | | | |
| Carina E (DK) | 1.8 | | 92 - | 7A-FE Cat. Lean Burn | 4 | 1,3 | BKR6EP-13 | 2550 | | | |
| Carina E (DK) | 2.0 | | 92 - | 3S-FE Cat. | 4 | 1,1 | BKR6EYA-11 | 4073 | | LPG 1 | 1496 |
| Carina E (DK) | 2.0 | | 92 - | 3S-FE Cat. Lean Burn | 4 | 1,1 | BKR6EP-11 | 2978 | | LPG 1 | 1496 |
| Carina E (AT190,191,ST191) | 1.6 | 77 | 93 - 97 | 4A-FE Lean Burn engine | 4 | 1,3 | BKR6EP-13 | 2550 | | | |
| Carina E (AT190,191,ST191) | 1.6 | | 93 - 97 | 4A-FE Standard engine | 4 | 0,8 | BKR6EYA | 2249 | | LPG 1 | 1496 |
| Carina E (AT190,191,ST191) | 1.8 | 79 | 95 - | 7A-FE | 4 | 1,3 | BKR6EP-13 | 2550 | | | |
| Carina E (AT190,191,ST191) | 2.0 | 98 | 93 - 97 | 3S-FE Cat. | 4 | 1,1 | BKR6EYA-11 | 4073 | | LPG 1 | 1496 |
| Carina E (AT190,191,ST191) | 2.0 | 116 | 93 - | 3S-GE Cat. | 4 | 0,8 | BKR6EP-8 | 2215 | | LPG 1 | 1496 |
| Carina II | 2.0 | 89 | - 88 | 3S-F | 4 | 0,9 | BCPR6EY | 1146 | | LPG 3 | 1498 |
| Carina II | 2.0 | | - 92 | 2C | 4 | █ | Y-146R | 7492 | | | |
| Carina II | 2.0 | | 93 - | 2C | 4 | █ | Y-703R | 3782 | | | |
| Carina II (AT151,ST150) | 1.6 | 52 | - 87 | 4A-C Cat. | 4 | 1,1 | BPR5EY-11 | 3028 | | LPG 2 | 1497 |
| Carina II (AT151,ST150) | 1.6 | 55 | - 87 | 4A | 4 | 0,8 | BPR5EY | 2828 | 9 | LPG 2 | 1497 |
| Carina II (AT151,ST150) | 1.6 | 55 | - 87 | 4A-C | 4 | 1,1 | BPR5EY-11 | 3028 | | LPG 2 | 1497 |
| Carina II (AT151,ST150) | 1.8 | 66 | - 87 | 1S | 4 | 0,8 | BPR5EY | 2828 | 9 | LPG 2 | 1497 |
| Carina II (AT151,ST150) | 1.8 | 74 | 85 - 87 | 1S-E | 4 | 0,8 | BPR5EY | 2828 | 9 | LPG 2 | 1497 |
| Carina II (AT171,177,ST171) | 1.6 | 66 | - 90 | 4A-F | 4 | 0,8 | BCRE527Y | 2074 | | | |
| Carina II (AT171,177,ST171) | 1.6 | 66 | 87 - 92 | 4A-F Cat. | 4 | 0,8 | BCRE527Y | 2074 | | | |
| Carina II (AT171,177,ST171) | 1.6 | 72 | 90 - 92 | 4A-FE | 4 | 0,8 | BCPR5EY | 1266 | | LPG 3 | 1498 |
| Carina II (AT171,177,ST171) | 1.6 | 72 | 90 - 92 | 4A-FE Cat. | 4 | 1,1 | BCPR6EIX-11 | 4919 | | LPG 3 | 1498 |
| Carina II (AT171,177,ST171) | 1.6 | 72 | 90 - 92 | 4A-FE with EGR | 4 | 0,8 | BCPR5EY | 1266 | | LPG 3 | 1498 |



ℓ kW

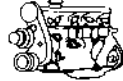

Cyl.

Order-
No.V-LINE
No.LPG/CNG
D-PowerOrder-
No.**TOYOTA**

| | | | | | | | | | | | |
|--|-----|-----|---------------|-------------------|---|-----|-------------|------|----|---------|------|
| Carina II (AT171,177,ST171) | 1.6 | 72 | 90 - 92 | 4A-FE without EGR | 4 | 1,1 | BCPR6EIX-11 | 4919 | | LPG 3 | 1498 |
| Carina II (AT171,177,ST171) | 1.6 | 75 | 88 - 90 | 4A-FE u.Cat. | 4 | 1,1 | BCPR6EIX-11 | 4919 | | LPG 3 | 1498 |
| Carina II (AT171,177,ST171) | 2.0 | 89 | 88 - 92 | 3S-F | 4 | 1,1 | BCPR6EY-11 | 3720 | | LPG 3 | 1498 |
| Carina II (AT171,177,ST171) | 2.0 | 98 | 88 - 92 | 3S-FE Cat. | 4 | 1,1 | BCPR6EY-11 | 3720 | | LPG 3 | 1498 |
| Celica | 2.0 | 77 | 81 - 84 | 21R | 4 | 0,8 | BPR6EY | 6427 | | LPG 2 | 1497 |
| Celica | 2.0 | 87 | 80 - 80 | 18R | 4 | 0,8 | BPR5EA-L | 5823 | | | |
| Celica | 2.0 | | 90 - 99 | 3S-GTE | 4 | 0,8 | BKR6EP-8 | 2215 | | LPG 1 | 1496 |
| Celica (AT160,162,165) | 2.0 | 103 | - 89 | 3S-GE Cat. | 4 | 1,1 | BCPR6EP-11 | 3350 | | LPG 3 | 1498 |
| Celica (AT160,162,165) | 2.0 | 110 | 86 - 89 | 3S-GE | 4 | 1,1 | BCPR6EY-11 | 3720 | | LPG 3 | 1498 |
| Celica (AT160,162,165) | 2.0 | | - 88 | 3S-FE | 4 | 1,1 | BCPR6EY-11 | 3720 | | LPG 3 | 1498 |
| Celica (AT160,ST162,165) | 1.6 | 62 | - 88 | 4A | 4 | 0,8 | BPR5EY | 2828 | 9 | LPG 2 | 1497 |
| Celica (AT160,ST162,165) | 1.6 | 91 | - 89 | 4A-GE | 4 | 1,1 | BCPR6EY-11 | 3720 | | LPG 3 | 1498 |
| Celica (AT160,ST162,165) | 1.6 | 91 | - 89 | 4A-GE Cat. | 4 | 1,1 | BCPR5EP-11 | 2097 | | LPG 3 | 1498 |
| Celica (AT180,200,ST182,184,185,202,204,205) | 2.0 | 115 | 90 - | 3S-GE Cat. | 4 | 0,8 | BKR6EP-8 | 2215 | | LPG 1 | 1496 |
| Celica (AT180,200,ST182,184,185,202,204,205) | 2.0 | 129 | 03.94 - | 3S-GE | 4 | 0,8 | BKR6EP-8 | 2215 | | LPG 1 | 1496 |
| Celica (AT180,ST182,184,185) | 1.6 | 77 | 90 - 94 | 4A-FE | 4 | 0,8 | BCPR5EY | 1266 | | LPG 3 | 1498 |
| Celica (AT180,ST182,184,185) | 2.2 | 100 | - 90 | 5S-FE Cat. | 4 | 1,1 | BKR5EYA-11 | 2526 | 39 | LPG 1 | 1496 |
| Celica (AT180,ST182,184,185) | 2.2 | 100 | 91 - | 5S-FE Cat. | 4 | 1,1 | BKR6EP-11 | 2978 | | LPG 1 | 1496 |
| Celica (AT200) | 2.0 | | 98 - | 3S-GE | 4 | 0,8 | BKR6EP-8 | 2215 | | LPG 1 | 1496 |
| Celica (AT200) | 2.2 | | 98 - | 5S-FE | 4 | 1,1 | BKR6EP-11 | 2978 | | LPG 1 | 1496 |
| Celica (AT200,ST202,204,205) | 1.8 | 85 | 03.94 - | 7A-FE | 4 | 0,8 | BKR6EYA | 2249 | | LPG 1 | 1496 |
| Celica (AT200,ST202,204,205) | 2.0 | 95 | 94 - | 3S-FE | 4 | 1,1 | BKR6EYA-11 | 4073 | | LPG 1 | 1496 |
| Celica (ST202,204,205) | 2.0 | | 98 - | 3S-GE | 4 | 0,8 | BKR6EP-8 | 2215 | | LPG 1 | 1496 |
| Celica (ST202,204,205) | 2.2 | | 98 - | 5S-FE | 4 | 1,1 | BKR6EP-11 | 2978 | | LPG 1 | 1496 |
| Celica (ZZT230,231) | 1.8 | | 08.99 - | 1ZZ-FE | 4 | 1,1 | BKR5EYA-11 | 2526 | 39 | LPG 1 | 1496 |
| Celica (ZZT230,231) | 1.8 | | 08.99 - | 2ZZ-GE | 4 | 1,1 | IFR6T11 | 4589 | | IFR6T11 | 4589 |
| Celica S (ZZT230) | 1.8 | 105 | 08.99 - | 1ZZ-FE | 4 | 1,1 | BKR5EYA-11 | 2526 | 39 | LPG 1 | 1496 |
| Celica Supra | 2.8 | 103 | 82 - 85 | 5M-E | 6 | 0,8 | BPR5EY | 2828 | 9 | LPG 2 | 1497 |
| Celica Supra | 2.8 | 125 | 12.81 - 12.85 | 5M-GE | 6 | 0,8 | BPR6EY | 6427 | | LPG 2 | 1497 |
| Celica Supra | 3.0 | | | 7M-GE | 6 | 0,9 | BCPR6EY | 1146 | | LPG 3 | 1498 |
| Celica Turbo | 2.0 | 136 | - 89 | 3S-GTE | 4 | 0,8 | BCPR5EP-8 | 2950 | | LPG 3 | 1498 |
| Celica Turbo (AT200,ST202,204,205) | 2.0 | 150 | 90 - | 3S-GTE | 4 | 0,8 | BKR6EP-8 | 2215 | | LPG 1 | 1496 |
| Coaster | | | - 93 | 13B | | | Y-197T | 2190 | | | |
| Coaster | | | - 93 | 13B | | | Y-147T | 7493 | | | |
| Coaster | | | 05.82 - | B, 2B, 3B | 4 | | Y-197R | 2188 | | | |
| Coaster | 4.0 | | 05.82 - | 2H | 6 | | Y-197R | 2188 | | | |
| Corolla | 1.2 | | | 3K | 4 | 0,9 | BPR5ES | 7422 | 6 | LPG 2 | 1497 |
| Corolla | 1.3 | | - 00 | 2A (8V SOHC) | 4 | 0,8 | BPR5EY | 2828 | 9 | LPG 2 | 1497 |
| Corolla | 1.3 | | 07.97 - 12.99 | 4E-FE | 4 | 1,1 | BKR5EYA-11 | 2526 | 39 | LPG 1 | 1496 |
| Corolla | 1.4 | | - 91 | | 4 | 0,9 | BPR5ES | 7422 | 6 | LPG 2 | 1497 |
| Corolla | 1.5 | | | 1N,1NT | 4 | | Y-118R | 2187 | | | |
| Corolla | 1.6 | 55 | | 2T | 4 | 0,8 | BPR5EA-L | 5823 | | | |
| Corolla | 1.6 | 81 | 07.97 - 07 | 4A-FE | 4 | 1,1 | BKR5EYA-11 | 2526 | 39 | LPG 1 | 1496 |
| Corolla | 1.6 | 85 | 93 - | 4A-GE Cat. | 4 | 0,8 | BKR6EYA | 2249 | | LPG 1 | 1496 |
| Corolla | 1.8 | | - 92 | 1C | 4 | | Y-146R | 7492 | | | |
| Corolla | 1.8 | | 12.92 - | 1C | 4 | | Y-703R | 3782 | | | |
| Corolla (AE110,111,112,115) | 1.3 | | 98 - 12.99 | 2E | 4 | 0,8 | BPR6EY | 6427 | | LPG 2 | 1497 |
| Corolla (AE110,111,112,115) | 1.3 | | 98 - 12.99 | 4E-FE | 4 | | BKR5EKB-11 | 3967 | | | |
| Corolla (AE110,111,112,115) | 1.5 | | 98 - 12.99 | 5A-FE | 4 | 1,1 | BKR5EYA-11 | 2526 | 39 | LPG 1 | 1496 |
| Corolla (AE110,111,112,115) | 1.6 | | 98 - 12.99 | 4A-F | 4 | 0,8 | BCRE527Y | 2074 | | | |



l kW



Cyl.

Order-
No. No.LPG/CNG
D-PowerOrder-
No.**TOYOTA**

| | | | | | | | | | | | |
|---|-----|----|------------|------------------|---|-----|------------|------|----|-------|------|
| Corolla (AE110,111,112,115) | 1.6 | | 98 - 12.99 | 4A-FE | 4 | 0,8 | BKR6EYA | 2249 | | LPG 1 | 1496 |
| Corolla (AE110,111,112,115) | 1.8 | | 98 - 12.99 | 7A-FE | 4 | 0,8 | BKR6EYA | 2249 | | LPG 1 | 1496 |
| Corolla (EE100,101,105,AE101,102) | 1.3 | | 93 - 97 | 2E | 4 | 0,8 | BPR6EY | 6427 | | LPG 2 | 1497 |
| Corolla (EE100,101,105,AE101,102) | 1.3 | | 94 - 07 | 2E | 4 | 0,8 | BPR6EY | 6427 | | LPG 2 | 1497 |
| Corolla (EE100,101,105,AE101,102) | 1.3 | | 95 - 12.99 | 2E o.Cat. | 4 | 1,1 | BPR5EY-11 | 3028 | | LPG 2 | 1497 |
| Corolla (EE100,101,105,AE101,102) | 1.3 | | 92 - 97 | 4E-FE | 4 | 0,8 | BKR5EYA | 2087 | | LPG 1 | 1496 |
| Corolla (EE100,101,105,AE101,102) | 1.4 | 65 | 92 - 94 | 4E-FE | 4 | 0,8 | BKR6EYA | 2249 | | LPG 1 | 1496 |
| Corolla (EE100,101,105,AE101,102) | 1.6 | 84 | 92 - 94 | 4A-FE | 4 | 0,8 | BKR6EYA | 2249 | | LPG 1 | 1496 |
| Corolla (EE100,101,105,AE101,102) | 1.6 | | 95 - 12.99 | 4A-FE | 4 | 0,8 | BKR6EYA | 2249 | | LPG 1 | 1496 |
| Corolla (EE100,101,105,AE101,102) | 1.8 | | 93 - 12.99 | 7A-FE | 4 | 0,8 | BKR6EYA | 2249 | | LPG 1 | 1496 |
| Corolla (EE105) | 1.3 | 63 | 07.97 - 07 | 2E | 4 | 0,8 | BPR6EY | 6427 | | LPG 2 | 1497 |
| Corolla (EE110,111) | 1.3 | | 98 - 12.99 | 2E | 4 | 0,8 | BPR6EY | 6427 | | LPG 2 | 1497 |
| Corolla (EE110,111) | 1.3 | | 98 - 12.99 | 4E-FE (16V DOHC) | 4 | | BKR5EKB-11 | 3967 | | | |
| Corolla (EE110,111) | 1.5 | | 98 - 12.99 | 5A-FE | 4 | 1,1 | BKR5EYA-11 | 2526 | 39 | LPG 1 | 1496 |
| Corolla (EE110,111) | 1.6 | | 98 - 12.99 | 4A-F | 4 | 0,8 | BCRE527Y | 2074 | | | |
| Corolla (EE110,111) | 1.6 | | 98 - 12.99 | 4A-FE | 4 | 0,8 | BKR6EYA | 2249 | | LPG 1 | 1496 |
| Corolla (EE110,111) | 1.8 | | 98 - 12.99 | 7A-FE | 4 | 0,8 | BKR6EYA | 2249 | | LPG 1 | 1496 |
| Corolla (EE110,111,AE110-112,115,ZZE111,112) | 1.3 | | 01.00 - 07 | 2E | 4 | 0,8 | BPR6EY | 6427 | | LPG 2 | 1497 |
| Corolla (EE110,111,AE110-112,115,ZZE111,112) | 1.3 | | 01.00 - 07 | 4E-FE | 4 | | BKR5EKB-11 | 3967 | | | |
| Corolla (EE110,111,AE110-112,115,ZZE111,112) | 1.4 | 71 | 01.00 - 07 | 4ZZ-FE | 4 | 1,1 | BKR5EYA-11 | 2526 | 39 | LPG 1 | 1496 |
| Corolla (EE110,111,AE110-112,115,ZZE111,112) | 1.5 | | 01.00 - 07 | 5A-FE | 4 | 1,1 | BKR5EYA-11 | 2526 | 39 | LPG 1 | 1496 |
| Corolla (EE110,111,AE110-112,115,ZZE111,112) | 1.6 | 81 | 01.00 - 07 | 3ZZ-FE | 4 | 1,1 | BKR5EYA-11 | 2526 | 39 | LPG 1 | 1496 |
| Corolla (EE110,111,AE110-112,115,ZZE111,112) | 1.6 | | 01.00 - 07 | 4A-F | 4 | 0,8 | BCRE527Y | 2074 | | | |
| Corolla (EE110,111,AE110-112,115,ZZE111,112) | 1.6 | | 01.00 - 07 | 4A-FE | 4 | 0,8 | BKR6EYA | 2249 | | LPG 1 | 1496 |
| Corolla (EE110,111,AE110-112,115,ZZE111,112) | 1.8 | | 01.00 - | 7A-FE | 4 | 0,8 | BKR6EYA | 2249 | | LPG 1 | 1496 |
| Corolla (EE80,90,97,100,105,AE82,92,95,101) | 1.3 | 55 | 86 - 92 | 2E | 4 | 1,1 | BPR6EY-11 | 4228 | 10 | LPG 2 | 1497 |
| Corolla (EE80,AE82) | 1.3 | 55 | 86 - 87 | 2E-C u.Cat. | 4 | 1,1 | BPR6EY-11 | 4228 | 10 | LPG 2 | 1497 |
| Corolla (EE80,AE82) | 1.6 | 52 | 85 - 87 | 4A-C | 4 | 0,8 | BPR5EY | 2828 | 9 | LPG 2 | 1497 |
| Corolla (EE80,AE82) | 1.6 | 52 | - 87 | 4A-C Cat. | 4 | 1,1 | BPR5EY-11 | 3028 | | LPG 2 | 1497 |
| Corolla (EE80,AE82) | 1.6 | 58 | - 87 | 4A Cat. | 4 | 1,1 | BPR5EY-11 | 3028 | | LPG 2 | 1497 |
| Corolla (EE80,AE82) | 1.6 | | 86 - 87 | 4A-GE Cat. | 4 | 1,1 | BPR5EY-11 | 3028 | | LPG 2 | 1497 |
| Corolla (EE80,AE82) | 1.6 | | 86 - 87 | 4A-GE o.Cat. | 4 | 1,1 | BCPR6EY-11 | 3720 | | LPG 3 | 1498 |
| Corolla (EE90,97,100,101,105,AE92,95,101,102) | 1.6 | 66 | 87 - 12.99 | 4A-F | 4 | 0,8 | BCRE527Y | 2074 | | | |
| Corolla (EE90,97,AE92,95) | 1.3 | 55 | 90 - 92 | 2E-E | 4 | 0,8 | BPR5EY | 2828 | 9 | LPG 2 | 1497 |
| Corolla (EE90,97,AE92,95) | 1.6 | 77 | 89 - 91 | 4A-FE Cat. | 4 | 0,8 | BCPR5EY | 1266 | | LPG 3 | 1498 |
| Corolla (EE90,97,AE92,95) | 1.6 | 85 | 90 - | 4A-GE Cat. | 4 | 0,8 | BKR6EP-8 | 2215 | | LPG 1 | 1496 |
| Corolla (EE90,AE92) | 1.6 | 85 | - 89 | 4A-GE Cat. | 4 | 1,1 | BCPR5EP-11 | 2097 | | LPG 3 | 1498 |
| Corolla (KE70,AE71,86) | 1.3 | 48 | 82 - 87 | 4K | 4 | 0,8 | BPR5EY | 2828 | 9 | LPG 2 | 1497 |
| Corolla (KE70,AE71,86) | 1.3 | 48 | - 86 | 4K-C | 4 | 0,8 | BPR4EY | 2128 | | LPG 2 | 1497 |
| Corolla (KE70,AE71,86,EE80,AE82) | 1.6 | 62 | - 87 | 4A | 4 | 0,8 | BPR5EY | 2828 | 9 | LPG 2 | 1497 |
| Corolla (NZE120,121 ZZE120,121,122,123) | 1.4 | 71 | 01.02 - 07 | 4ZZ-FE | 4 | 1,1 | BKR5EYA-11 | 2526 | 39 | LPG 1 | 1496 |



ℓ kW



Cyl.

Order-
No.V-LINE
No.LPG/CNG
D-PowerOrder-
No.**TOYOTA**

| | | | | | | | | | | | |
|-------------------------------------|-----|-----|------------|------------|---|-----|-------------|------|----|------------|------|
| Corolla (NZE120,121) | 1.3 | | 10.01 - 07 | 2NZ-FE | 4 | 1,1 | BKR5EYA-11 | 2526 | 39 | LPG 1 | 1496 |
| Corolla (NZE120,121) | 1.4 | | 10.01 - 07 | 4ZZ-FE | 4 | 1,1 | BKR5EYA-11 | 2526 | 39 | LPG 1 | 1496 |
| Corolla (NZE120,121) | 1.5 | | 10.01 - 07 | 1NZ-FE | 4 | 1,1 | BKR5EYA-11 | 2526 | 39 | LPG 1 | 1496 |
| Corolla (NZE120,121) | 1.6 | 81 | 10.01 - 07 | 3ZZ-FE | 4 | 1,1 | BKR5EYA-11 | 2526 | 39 | LPG 1 | 1496 |
| Corolla (NZE120,121) | 1.8 | 99 | 10.01 - 07 | 1ZZ-FE | 4 | 1,1 | BKR5EYA-11 | 2526 | 39 | LPG 1 | 1496 |
| Corolla (NZE120,121) | 1.8 | 141 | 10.01 - 07 | 2ZZ-GE | 4 | 1,1 | IFR6T11 | 4589 | | IFR6T11 | 4589 |
| Corolla (ZZE120,121,122,123) | 1.3 | | 10.01 - 07 | 2NZ-FE | 4 | 1,1 | BKR5EYA-11 | 2526 | 39 | LPG 1 | 1496 |
| Corolla (ZZE120,121,122,123) | 1.4 | | 10.01 - 07 | 4ZZ-FE | 4 | 1,1 | BKR5EYA-11 | 2526 | 39 | LPG 1 | 1496 |
| Corolla (ZZE120,121,122,123) | 1.5 | | 10.01 - 07 | 1NZ-FE | 4 | 1,1 | BKR5EYA-11 | 2526 | 39 | LPG 1 | 1496 |
| Corolla (ZZE120,121,122,123) | 1.6 | 81 | 10.01 - 07 | 3ZZ-FE | 4 | 1,1 | BKR5EYA-11 | 2526 | 39 | LPG 1 | 1496 |
| Corolla (ZZE120,121,122,123) | 1.8 | 99 | 10.01 - 07 | 1ZZ-FE | 4 | 1,1 | BKR5EYA-11 | 2526 | 39 | LPG 1 | 1496 |
| Corolla (ZZE120,121,122,123) | 1.8 | 141 | 10.01 - 07 | 2ZZ-GE | 4 | 1,1 | IFR6T11 | 4589 | | IFR6T11 | 4589 |
| Corolla (ZZE121) | 1.6 | 81 | 11.01 - 07 | 3ZZ-FE | 4 | 1,1 | BKR5EYA-11 | 2526 | 39 | LPG 1 | 1496 |
| Corolla (ZZE123) Sport | 1.8 | 141 | 02 - 07 | 2ZZ-GE | 4 | 1,1 | IFR6T11 | 4589 | | IFR6T11 | 4589 |
| Corolla 4WD | 1.6 | 84 | 93 - | 4A-FE | 4 | 0,8 | BCPR5EY | 1266 | | LPG 3 | 1498 |
| Corolla 4WD | 1.6 | | 95 - | 4A-FE | 4 | 0,8 | BCPR5EY | 1266 | | LPG 3 | 1498 |
| Corolla EE110,111,AE110,111,112,115 | 1.4 | | 01.98 - 07 | 4E-FE | 4 | | BKR5EKB-11 | 3967 | | | |
| Corolla Luna D-4D | 1.4 | 66 | 04 - 07 | 1ND-TV | 4 | █ | Y-542J | 5513 | | D-POWER 45 | 5513 |
| Corolla Spacio (AE111) | 1.6 | | 01.00 - 07 | 4A-FE | 4 | 0,8 | BKR6EYA | 2249 | | LPG 1 | 1496 |
| Corolla Spacio (AE111) | 1.6 | | 01.01 - 07 | 4A-FE | 4 | 0,8 | BKR6EYA | 2249 | | LPG 1 | 1496 |
| Corolla Verso (ZZE121, 122) | 1.6 | | 09.01 - 07 | 3ZZ-FE | 4 | 1,1 | BKR5EYA-11 | 2526 | 39 | LPG 1 | 1496 |
| Corolla Verso (ZZE121, 122) | 2.0 | | 09.01 - 07 | 1ZZ-FE | 4 | 1,1 | BKR5EYA-11 | 2526 | 39 | LPG 1 | 1496 |
| Corolla Verso (ZNR10) | 1.6 | | 08.05 - 07 | 3ZZ-FE | 4 | 1,1 | BKR5EYA-11 | 2526 | 39 | LPG 1 | 1496 |
| Corolla Verso (ZNR10) | 1.8 | 99 | 08.05 - 07 | 1ZZ-FE | 4 | 1,1 | BKR5EYA-11 | 2526 | 39 | LPG 1 | 1496 |
| Corolla Verso D-4D (CE120,CDE120) | 2.0 | 85 | 10.01 - 07 | 1CD-FTV | 4 | █ | Y-531J | 5467 | | D-POWER 44 | 5467 |
| Corona | 1.8 | 57 | 86 - | 2Y | 4 | 0,8 | BPR5EY | 2828 | 9 | LPG 2 | 1497 |
| Corona | 2.0 | | - 92 | 2C | 4 | █ | Y-146R | 7492 | | | |
| Corona | 2.0 | | 93 - | 2C | 4 | █ | Y-703R | 3782 | | | |
| Corona | 2.2 | | 08.82 - | L | 4 | █ | Y-118T1 | 2951 | | | |
| Corona Super Glow System | 2.2 | | 08.82 - | L | 4 | █ | Y-118R | 2187 | | | |
| Corona (AZT220) | 1.6 | | 01.02 - | 3ZZ-FE | 4 | 1,1 | BKR5EYA-11 | 2526 | 39 | LPG 1 | 1496 |
| Corona (AZT220) | 1.8 | | 01.02 - | 1ZZ-FE | 4 | 1,1 | BKR5EYA-11 | 2526 | 39 | LPG 1 | 1496 |
| Corona (AZT220) | 2.0 | | 01.02 - | 3S-FE | 4 | | BKR6EKB-11 | 3583 | | | |
| Corona (ST220) | 1.6 | | 01.02 - | 3ZZ-FE | 4 | 1,1 | BKR5EYA-11 | 2526 | 39 | LPG 1 | 1496 |
| Corona (ST220) | 1.8 | | 01.02 - | 1ZZ-FE | 4 | 1,1 | BKR5EYA-11 | 2526 | 39 | LPG 1 | 1496 |
| Corona (ST220) | 2.0 | | 01.02 - | 3S-FE | 4 | | BKR6EKB-11 | 3583 | | | |
| Corona (ZZT220, 221) | 1.6 | | 01.02 - | 3ZZ-FE | 4 | 1,1 | BKR5EYA-11 | 2526 | 39 | LPG 1 | 1496 |
| Corona (ZZT220, 221) | 1.8 | | 01.02 - | 1ZZ-FE | 4 | 1,1 | BKR5EYA-11 | 2526 | 39 | LPG 1 | 1496 |
| Corona (ZZT220, 221) | 2.0 | | 01.02 - | 3S-FE | 4 | | BKR6EKB-11 | 3583 | | | |
| Corona (AT151,ST150) | 1.6 | 55 | - 87 | 4A-C Cat. | 4 | 1,1 | BPR5EY-11 | 3028 | | LPG 2 | 1497 |
| Corona (AT151,ST150) | 1.6 | | - 87 | 4A | 4 | 0,8 | BPR5EY | 2828 | 9 | LPG 2 | 1497 |
| Corona (AT151,ST150) | 1.6 | | - 87 | 4A-C | 4 | 0,8 | BPR5EY | 2828 | 9 | LPG 2 | 1497 |
| Corona (AT151,ST150) | 1.8 | 64 | - 87 | 1S | 4 | 0,8 | BPR5EY | 2828 | 9 | LPG 2 | 1497 |
| Corona (AT151,ST150) | 1.8 | 74 | - 87 | 1S-E | 4 | 0,8 | BPR5EY | 2828 | 9 | LPG 2 | 1497 |
| Corona (AT171,177,ST171) | 1.6 | 66 | 88 - 92 | 4A-F Cat. | 4 | 0,8 | BCRE527Y | 2074 | | | |
| Corona (AT171,177,ST171) | 1.6 | 72 | 90 - 92 | 4A-FE | 4 | 1,1 | BCPR6EIX-11 | 4919 | | LPG 3 | 1498 |
| Corona (AT171,177,ST171) | 1.6 | 75 | 90 - 92 | 4A-FE | 4 | 0,8 | BCPR5EY | 1266 | | LPG 3 | 1498 |
| Corona (AT171,177,ST171) | 1.6 | | - 89 | 4A-FE Cat. | 4 | 1,1 | BCPR5EP-11 | 2097 | | LPG 3 | 1498 |
| Corona (AT171,177,ST171) | 2.0 | 89 | - 92 | 3S-FE Cat. | 4 | 1,1 | BCPR6EY-11 | 3720 | | LPG 3 | 1498 |
| Corona (AT171,177,ST171) | 2.0 | 116 | 92 - | 3S-GE | 4 | 0,8 | BKR6EP-8 | 2215 | | LPG 1 | 1496 |
| Corona (AT171,177,ST171) | 2.0 | | - 92 | 3S-F | 4 | 1,1 | BCPR6EY-11 | 3720 | | LPG 3 | 1498 |
| Corona (AT190,191,ST191) | 2.0 | 98 | 93 - | 3S-FE | 4 | 1,1 | BKR6EYA-11 | 4073 | | LPG 1 | 1496 |



l kW



Cyl.

Order-
No. No.LPG/CNG
D-PowerOrder-
No.**TOYOTA**

| | | | | | | | | | | | |
|------------------------------|-----|-----|---------------|--------------------------|---|-----|------------|------|----|------------|------|
| Corona (AT190,ST191) | 1.6 | | 93 - | 4A-FE | 4 | 1,1 | BKR5EYA-11 | 2526 | 39 | LPG 1 | 1496 |
| Corona (AT220,221,ST220) | 1.6 | 81 | 04.98 - | 4A-FE | 4 | 1,3 | BKR6EP-13 | 2550 | | | |
| Corona (AT220,221,ST220) | 1.8 | 81 | 01.98 - | 7A-FE | 4 | 1,3 | BKR6EP-13 | 2550 | | | |
| Corona (AT220,221,ST220) | 2.0 | 94 | 01.98 - | 3S-FE | 4 | | BKR6EKP-11 | 3452 | | | |
| Corona (ST210, AT210) | 1.6 | | 01.00 - | 4A-FE | 4 | 0,8 | BKR6EYA | 2249 | | LPG 1 | 1496 |
| Corona (ST210, AT210) | 2.0 | | 01.00 - | 3S-FE | 4 | | BKR6EKB-11 | 3583 | | | |
| Cressida | 2.0 | 66 | 80 - 80 | 18R | 4 | 0,8 | BPR5EA-L | 5823 | | | |
| Cressida | 2.0 | 73 | 81 - 84 | 21R | 4 | 0,8 | BPR6EY | 6427 | | LPG 2 | 1497 |
| Cressida | 2.0 | 73 | 85 - | 21R | 4 | 0,8 | BPR5EY | 2828 | 9 | LPG 2 | 1497 |
| Cressida | 2.0 | 80 | - 88 | 1G-E | 4 | 0,8 | BPR6EY | 6427 | | LPG 2 | 1497 |
| Cressida | 2.0 | 99 | 90 - | 1G-FE | 4 | 0,8 | BKR6EYA | 2249 | | LPG 1 | 1496 |
| Cressida | 2.2 | | 08.82 - | L | 4 | █ | Y-118T1 | 2951 | | | |
| Cressida | 2.5 | | 93 - | 2L | 4 | █ | Y-715R | 5376 | | | |
| Cressida | 2.8 | 92 | 84 - | 5M-E | 6 | 0,8 | BPR5EY | 2828 | 9 | LPG 2 | 1497 |
| Cressida | 2.8 | 125 | 85 - | 5M-GE | 6 | 0,8 | BPR6EY | 6427 | | LPG 2 | 1497 |
| Cressida | 3.0 | 142 | 88 - | 7M-GE Cat. | 6 | 1,1 | BCPR5EP-11 | 2097 | | LPG 3 | 1498 |
| Cressida Super Glow System | 2.2 | | 08.82 - | L | 4 | █ | Y-118R | 2187 | | | |
| Crown | | | 09.83 - 91 | 2L | 4 | █ | Y-118T1 | 2951 | | | |
| Crown | 2.0 | | 93 - | 1G-FE | 4 | 0,8 | BKR6EYA | 2249 | | LPG 1 | 1496 |
| Crown | 2.2 | | 08.80 - | L | 4 | █ | Y-118T1 | 2951 | | | |
| Crown | 2.5 | | 93 - | 2L | 4 | █ | Y-715R | 5376 | | | |
| Crown | 2.8 | | - 85 | 5M-GE | 6 | 0,8 | BPR6EY | 6427 | | LPG 2 | 1497 |
| Crown | 2.8 | | 86 - | 5M-GE | 6 | 0,8 | BPR5EY | 2828 | 9 | LPG 2 | 1497 |
| Crown | 3.0 | | 93 - 12.99 | 2JZ-GE | 6 | 0,8 | BKR6EYA | 2249 | | LPG 1 | 1496 |
| Crown Super Glow System | 2.2 | | 08.80 - | L | 4 | █ | Y-118R | 2187 | | | |
| Crown (GS151) | 2.0 | | 98 - | 1G-FE | 4 | 1,1 | BKR5EYA-11 | 2526 | 39 | LPG 1 | 1496 |
| Crown (GS151) | 2.9 | | 98 - | 2JZ-GE with 3way cat. | 6 | | BKR5EKB-11 | 3967 | | | |
| Crown (GS151) | 2.9 | | 98 - | 2JZ-GE without 3way cat. | 6 | 0,8 | BKR6EYA | 2249 | | LPG 1 | 1496 |
| Crown (JZS155) | 2.0 | | 98 - | 1G-FE | 4 | 1,1 | BKR5EYA-11 | 2526 | 39 | LPG 1 | 1496 |
| Crown (JZS155) | 2.9 | | 98 - 12.99 | 2JZ-GE with 3way cat. | 6 | | BKR5EKB-11 | 3967 | | | |
| Crown (JZS155) | 2.9 | | 98 - | 2JZ-GE without 3way cat. | 6 | 0,8 | BKR6EYA | 2249 | | LPG 1 | 1496 |
| Crown (JZS155) | 3.0 | | 01.00 - | 2JZ-GE | 6 | | BKR5EKP-11 | 4302 | | | |
| Dyna (KDY220,230,250,260) | 2.5 | | 08.01 - | 2KD-FTV | 4 | █ | Y-531J | 5467 | | D-POWER 44 | 5467 |
| Dyna 2500 | | | 93 - | 2L | | █ | Y-715R | 5376 | | | |
| Dyna 2800 | 2.8 | | 93 - | 3L | 4 | █ | Y-715R | 5376 | | | |
| Dyna 3000 | | | 08.80 - | 2B | | █ | Y-197T | 2190 | | | |
| Dyna 3000 | | | 04.82 - | 3B | 4 | █ | Y-197T | 2190 | | | |
| Dyna 3000 | | | 08.80 - 04.82 | 3B | 4 | █ | Y-178T | 3030 | | | |
| Dyna 3000 | 3.0 | | 90 - 91 | B | 4 | █ | Y-178T | 3030 | | | |
| Dyna 3000 | 3.0 | | 04.82 - | B | 4 | █ | Y-147T | 7493 | | | |
| Dyna 3000 | 3.0 | | 05.82 - 89 | B | 4 | █ | Y-197R | 2188 | | | |
| Dyna 3000 | 3.0 | | 08.80 - 04.82 | B | 4 | █ | Y-178T | 3030 | | | |
| Dyna 3000 | 3.0 | | 93 - | B / 11B | 4 | █ | Y-197T | 2190 | | | |
| Dyna 3000 | 3.0 | | 93 - | B / 11B | 4 | █ | Y-147T | 7493 | | | |
| Dyna 3700 | | | 93 - | 14B | | █ | Y-197T | 2190 | | | |
| Dyna 3700 | | | 93 - | 14B | | █ | Y-147T | 7493 | | | |
| Dyna 3700 | | | 04.82 - | H, 2H | 6 | █ | Y-197R | 2188 | | | |
| Echo NLP10 | 1.4 | 55 | 02 - | 1ND-TV | 4 | █ | Y-542J | 5513 | | D-POWER 45 | 5513 |
| Echo Verso NLP20/22 | 1.4 | | 02 - | 1ND-TV | 4 | █ | Y-542J | 5513 | | D-POWER 45 | 5513 |
| Echo (NCP10,11,12,13, SCP10) | 1.5 | 78 | 01.02 - | 1NZ-FE | 4 | 0,8 | BKR5EYA | 2087 | | LPG 1 | 1496 |
| Echo (NCP20, 21, 22) | 1.5 | 78 | 01.02 - | 1NZ-FE | 4 | 0,8 | BKR5EYA | 2087 | | LPG 1 | 1496 |
| Echo (NCP10,11,12,13, SCP10) | 1.3 | | 01.01 - | 2NZ-FE | 4 | 1,1 | BKR5EYA-11 | 2526 | 39 | LPG 1 | 1496 |



ℓ kW



Cyl.

Order-
No.V-LINE
No.LPG/CNG
D-PowerOrder-
No.**TOYOTA**

| | | | | | | | | | | | |
|--|-----|-----|---------------|-------------|---|-----|------------|------|----|------------|------|
| Echo (NCP10,11,12,13, SCP10) | 1.5 | 78 | 01.01 - 12.01 | 1NZ-FE | 4 | 1,1 | BKR5EYA-11 | 2526 | 39 | LPG 1 | 1496 |
| Echo (SCP10,NCP10,11,12,13) | 1.0 | | 01.99 - | 1SZ-FE | 4 | 0,8 | BKR5EYA | 2087 | | LPG 1 | 1496 |
| Echo Verso (NCP20,21 ,22) | 1.3 | 63 | 08.99 - | 2NZ-FE | 4 | 1,1 | BKR5EYA-11 | 2526 | 39 | LPG 1 | 1496 |
| Hiace | 1.8 | 58 | 82 - 85 | 2Y,2Y-C | 4 | 0,8 | BPR5EY | 2828 | 9 | LPG 2 | 1497 |
| Hiace | 1.8 | | 95 - | 2Y o.Cat. | 4 | 0,8 | BPR5EY | 2828 | 9 | LPG 2 | 1497 |
| Hiace | 2.4 | | 09.83 - 92 | 2L | 4 | █ | Y-118T1 | 2951 | | | |
| Hiace | 2.4 | | - 92 | 2L 12V | 4 | █ | Y-118R | 2187 | | | |
| Hiace | 2.4 | | - 92 | 2L 24V | 4 | █ | Y-168R | 2162 | | | |
| Hiace (LH102-104,112-115,125) | 2.5 | | 98 - | 2L | 4 | █ | Y-715R | 5376 | | | |
| Hiace (LH102-104,112-115,125) | 2.8 | | 98 - | 3L | 4 | █ | Y-715R | 5376 | | | |
| Hiace Super Glow System | 2.4 | | 09.83 - 92 | 2L | 4 | █ | Y-118R | 2187 | | | |
| Hiace Super Glow System | 2.4 | | 09.83 - 92 | 2L | 4 | █ | Y-118R | 2187 | | | |
| Hiace (KLH 12, 22 28) | 2.5 | | 08.01 - | 2KD-FTV | 4 | █ | Y-531J | 5467 | | D-POWER 44 | 5467 |
| Hiace (RCH 13,19,23,29) | 2.7 | | 01.04 - | 3RZ-FE | 4 | 1,1 | IFR5T11 | 4996 | | IFR5T11 | 4996 |
| Hiace (RCH12,13,19,22,23,29) | 2.4 | | 01.00 - | 2RZ-E | 4 | 1,1 | BPR5EP-11 | 3971 | | | |
| Hiace (RCH12,13,19,22,23,29) | 2.7 | 105 | 01.00 - 03 | 3RZ-FE | 6 | 0,8 | IFR5T-8N | 3508 | | IFR5T-8N | 3508 |
| Hiace (RZH102,103,104,109, 112-115,119,125) | 2.0 | 74 | 90 - 98 | 1R-Z | 4 | 0,8 | BPR5EY | 2828 | 9 | LPG 2 | 1497 |
| Hiace (RZH102,103,104,109, 112-115,119,125) | 2.4 | 88 | 90 - | 2R-ZE | 4 | 1,1 | BPR5EP-11 | 3971 | | | |
| Hiace (RZH102,103,104,109, 112-115,119,125) | 2.4 | | 90 - | 2R-Z | 4 | 0,8 | BP5EY | 7327 | | LPG 2 | 1497 |
| Hiace (RZH102-105,112-115, 125,135,153, 155 | 2.4 | | 98 - | 2RZ | 4 | 0,8 | BP5EY | 7327 | | LPG 2 | 1497 |
| Hiace (RZH102-105,112-115, 125,135,153,155 | 2.0 | | 98 - | 1RZ | 4 | 0,8 | BP5EY | 7327 | | LPG 2 | 1497 |
| Hiace (RZH102-105,112-115, 125,135,153,155 | 2.4 | | 98 - | 2RZ-E | 4 | 1,1 | BPR5EP-11 | 3971 | | | |
| Hiace (YH51,53,56,60,61,63,66,73) | 2.0 | 65 | 85 - 89 | 3Y | 4 | 0,8 | BPR5EY | 2828 | 9 | LPG 2 | 1497 |
| Hiace (YH51,53,56,60,61,63,66,73) | 2.2 | 69 | - 89 | 4Y, 4YZ | 4 | 0,8 | BPR5EY | 2828 | 9 | LPG 2 | 1497 |
| Hiace 2500 (LH102-104,112-115,125) | 2.4 | | 93 - | 2L | 4 | █ | Y-715R | 5376 | | | |
| Hiace 2800 | 2.8 | | 93 - | 3L | 4 | █ | Y-715R | 5376 | | | |
| Hiace 3000 | 3.0 | | 93 - | B / 11B 12V | 4 | █ | Y-147T | 7493 | | | |
| Hiace 3000 | 3.0 | | 93 - | B / 11B 24V | 4 | █ | Y-197T | 2190 | | | |
| Hiace 3700 | | | 93 - | 14B 12V | | █ | Y-147T | 7493 | | | |
| Hiace 3700 | | | 93 - | 14B 24V | | █ | Y-197T | 2190 | | | |
| Hilux | | | 09.83 - 92 | 2L | 4 | █ | Y-118T1 | 2951 | | | |
| Hilux | 1.6 | | 90 - 90 | 1Y,1Y-C | 4 | 0,8 | BPR5EY | 2828 | 9 | LPG 2 | 1497 |
| Hilux | 1.8 | 61 | 88 - 94 | 2Y | 4 | 0,8 | BPR5EY | 2828 | 9 | LPG 2 | 1497 |
| Hilux | 1.8 | | 95 - | 2Y | 4 | 0,8 | BP5EY | 7327 | | LPG 2 | 1497 |
| Hilux | 2.0 | | 95 - | 3Y | 4 | 0,8 | BP5EY | 7327 | | LPG 2 | 1497 |
| Hilux | 2.0 | | 88 - 94 | 3Y,3Y-C | 4 | 0,8 | BPR5EY | 2828 | 9 | LPG 2 | 1497 |
| Hilux | 2.2 | | 95 - | 4Y | 4 | 0,8 | BP5EY | 7327 | | LPG 2 | 1497 |
| Hilux | 2.2 | | 88 - 94 | 4Y,4Y-C | 4 | 0,8 | BPR5EY | 2828 | 9 | LPG 2 | 1497 |
| Hilux | 2.2 | | - 89 | 4Y-E | 4 | 1,1 | BPR5EY-11 | 3028 | | LPG 2 | 1497 |
| Hilux | 2.2 | | 90 - 90 | 4Y-E | 4 | 1,1 | BPR5EP-11 | 3971 | | | |
| Hilux | 2.4 | 84 | 88 - | 22R-E Cat. | 4 | 0,8 | BPR5EY | 2828 | 9 | LPG 2 | 1497 |
| Hilux | 2.4 | | 88 - | 22R | 4 | 0,8 | BPR5EY | 2828 | 9 | LPG 2 | 1497 |
| Hilux | 2.4 | | - 92 | 2L 12V | 4 | █ | Y-118R | 2187 | | | |
| Hilux | 2.4 | | - 92 | 2L 24V | 4 | █ | Y-168R | 2162 | | | |
| Hilux | 2.7 | | 96 - | 3RZ-FE | 6 | 0,8 | BKR5EYA | 2087 | | LPG 1 | 1496 |
| Hilux | 3.0 | 105 | 89 - | 3VZ-E | 6 | 0,8 | BKR5EYA | 2087 | | LPG 1 | 1496 |



ℓ kW

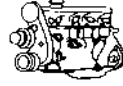

Cyl.

Order-
No. No.LPG/CNG
D-PowerOrder-
No.**TOYOTA**

| | | | | | | | | | | | | |
|---|-----|-----|---------------|---------------------|---|-----|------------|-------|---|------------|--|------|
| Hilux | 3.4 | | 96 - | 5VZ-FE | 6 | | BKR5EKB-11 | 3967 | | | | |
| Hilux (VZN 167, 172) | 2.4 | | 01.01 - | 2RZ-FE | 6 | 0,8 | BKR5EYA | 2087 | | LPG 1 | | 1496 |
| Hilux Super Glow System | 2.4 | | 09.83 - 92 | 2L | 4 | █ | Y-118R | 2187 | | | | |
| Hilux (GRN215W) | 4.0 | | 08.05 - | 1GR-FE | 6 | 1,1 | LFR6C-11 | 5788 | | | | |
| Hilux Super Glow System | | | 09.83 - 92 | 2L | 4 | █ | Y-118R | 2187 | | | | |
| Hilux (GGN15,25) | 4.0 | 175 | 07.05 - | 1GR-FE | 6 | 1,1 | LFR6C-11 | 5788 | | | | |
| Hilux (KDN145,150,165,170,190) | 2.5 | | 08.01 - | 2KD-FTV | 4 | █ | Y-531J | 5467 | | D-POWER 44 | | 5467 |
| Hilux (TGN10,11,15,16,26,36) | 2.0 | 100 | 07.05 - | 1TR-FE | 4 | 1,1 | LFR6C-11 | 5788 | | | | |
| Hilux (TNG10,11,15,16,26,36) | 2.7 | 118 | 07.05 - | 2TR-FE | 4 | 1,1 | LFR6C-11 | 5788 | | | | |
| Hilux 2500 | | | - 90 | 2C | 4 | █ | Y-703R | 3782 | | | | |
| Hilux 2500 | 2.4 | | 93 - | 2L | 4 | █ | Y-715R | 5376 | | | | |
| Hilux 2800 | 2.8 | | 93 - | 3L | 4 | █ | Y-715R | 5376 | | | | |
| Hilux(RZN142,144,147-149, 154,168,169,173,174,193) | 2.0 | | 01.01 - | 1RZ | 4 | 0,8 | BP5EY | 7327 | | LPG 2 | | 1497 |
| Hilux(RZN142,144,147-149, 154,168,169,173,174,193) | 2.0 | | 01.01 - | 1RZ-E | 4 | 0,8 | BPR5EY | 2828 | 9 | LPG 2 | | 1497 |
| Hilux(RZN142,144,147-149, 154,168,169,173,174,193) | 2.4 | | 01.01 - | 2RZ-FE | 6 | 0,8 | BKR5EYA | 2087 | | LPG 1 | | 1496 |
| Hilux(RZN142,144,147-149, 154,168,169,173,174,193) | 2.7 | | 01.01 - | 3RZ-F | 6 | 0,8 | BKR5EYA | 2087 | | LPG 1 | | 1496 |
| Hilux(RZN142,144,147-149, 154,168,169,173,174,193) | 2.7 | | 01.01 - | 3RZ-FE | 6 | 0,8 | BKR5EYA | 2087 | | LPG 1 | | 1496 |
| Hilux(VZN 167, 172) | 2.0 | | 01.01 - | 1RZ | 4 | 0,8 | BP5EY | 7327 | | LPG 2 | | 1497 |
| iQ 1.0 VVT-i (KGJ10) | 1.0 | 50 | 11.08 - | 1KR-FE | 3 | 1,1 | ILFR5T-11 | 96779 | | ILFR6T11 | | 4904 |
| iQ 1.3 (NGJ10) | 1.3 | 72 | 05.09 - | 1NR-FE | 4 | | ILKAR7B11 | 4912 | | ILKAR7B11 | | 4912 |
| iQ 1.4 D-4D (NUJ10) | 1.4 | 66 | 11.08 - | 1ND-TV | 4 | █ | Y-542J | 5513 | | D-POWER 45 | | 5513 |
| Land Cruiser | | | 10.81 - | 2B | | █ | Y-197R | 2188 | | | | |
| Land Cruiser | | | | 3B 4 Zyl., 2H 6Zyl. | 6 | █ | Y-147T | 7493 | | | | |
| Land Cruiser | | | 08.80 - 10.81 | 3B 4 Zyl., 2H 6Zyl. | | █ | Y-197R | 2188 | | | | |
| Land Cruiser | | | 05.82 - | H / 2H | 6 | █ | Y-197R | 2188 | | | | |
| Land Cruiser | 2.4 | 77 | - 12.96 | 22R-E | 4 | 0,8 | BPR5EY | 2828 | 9 | LPG 2 | | 1497 |
| Land Cruiser | 2.4 | | | 2L 2.4L | 4 | █ | Y-118R | 2187 | | | | |
| Land Cruiser | 2.5 | | 90 - | 2L 2.5L | 4 | █ | Y-715R | 5376 | | | | |
| Land Cruiser | 2.5 | | 93 - | 2L-T | 4 | █ | Y-715R | 5376 | | | | |
| Land Cruiser | 2.8 | | 93 - | 3L | 4 | █ | Y-715R | 5376 | | | | |
| Land Cruiser | 3.0 | | 08.80 - 03.81 | B | 4 | █ | Y-197R | 2188 | | | | |
| Land Cruiser | 4.2 | 88 | 81 - | 2F | 6 | 0,8 | BPR4EY | 2128 | | LPG 2 | | 1497 |
| Land Cruiser | 4.5 | | 93 - | 1FZ-FE | 6 | 0,8 | BKR5EYA | 2087 | | LPG 1 | | 1496 |
| Land Cruiser (20W/121W) | 4.0 | | 08.05 - | 1GR-FE | 6 | 1,1 | LFR6C-11 | 5788 | | | | |
| Land Cruiser (TRJ120,125) (GRJ120, 125) | 2.7 | | 01.05 - | 2TR-FE | 6 | 1,1 | ILFR6T11 | 4904 | | ILFR6T11 | | 4904 |
| Land Cruiser (URJ202W) | 4.6 | | 09 - | 1UR-FE | 8 | 1,1 | LFR6AIX-11 | 6619 | | | | |
| Land Cruiser (FJ62,70,73,75,RJ70) | 2.4 | 77 | | 22R | 4 | 0,8 | BPR5EY | 2828 | 9 | LPG 2 | | 1497 |
| Land Cruiser (FJ62,70,73,75,RJ70) | 4.0 | 107 | 88 - | 3F | 6 | 0,8 | BPR4EY | 2128 | | LPG 2 | | 1497 |
| Land Cruiser (FJ62,70,73,75,RJ70) | 4.0 | 115 | 01.90 - 08.92 | 3F-E Cat. | 6 | 1,1 | BPR5EY-11 | 3028 | | LPG 2 | | 1497 |
| Land Cruiser (FJ62,70,73,75,RJ70) | 4.0 | | 08.87 - 12.89 | 3F-E | 6 | 0,8 | BPR5EY | 2828 | 9 | LPG 2 | | 1497 |
| Land Cruiser (FZJ100,105) | 4.5 | | 98 - 12.99 | 1FZ-FE | 6 | | BKR5EKB-11 | 3967 | | | | |
| Land Cruiser (FZJ100,105) | 4.5 | | 01.02 - | 1FZ-FE | 6 | | BKR5EKB-11 | 3967 | | | | |
| Land Cruiser (FZJ100,105) | 4.7 | 173 | 01.98 - | 2UZ-FE | 8 | 1,1 | IFR6T11 | 4589 | | IFR6T11 | | 4589 |
| Land Cruiser (FZJ70,73,75) | 4.5 | | 98 - 12.99 | 1FZ-F | 6 | 0,8 | BKR5EYA | 2087 | | LPG 1 | | 1496 |
| Land Cruiser (FZJ70,73,75) | 4.5 | | 98 - 12.99 | 1FZ-FE | 6 | 0,8 | BKR5EYA | 2087 | | LPG 1 | | 1496 |
| Land Cruiser (FZJ71,74,78,79) | 4.5 | | 01.00 - | 1FZ-FE | 6 | | BKR5EKB-11 | 3967 | | | | |



ℓ kW



Cyl.

Order-
No.V-LINE
No.LPG/CNG
D-PowerOrder-
No.**TOYOTA**

| | | | | | | | | | | | |
|-------------------------------------|-----|-----|---------------|--------------------------|---|-----|------------|------|----|------------|------|
| Land Cruiser (FZJ80) | 4.5 | | 96 - | 1FZ-F | 6 | 0,8 | BKR5EYA | 2087 | | LPG 1 | 1496 |
| Land Cruiser (HDJ100) | 4.2 | | 98 - | 1HD-T | 6 | █ | Y-532J | 7782 | | | |
| Land Cruiser (HZJ105) | 4.2 | | 98 - | 1HD-T | 6 | █ | Y-532J | 7782 | | | |
| Land Cruiser (HZJ70,73,75) | 2.5 | | | 2L-T | 4 | █ | Y-715R | 5376 | | | |
| Land Cruiser (KDJ 120,125) | 3.0 | | 09.02 - | 1KD-FTV | | █ | Y-531J | 5467 | | D-POWER 44 | 5467 |
| Land Cruiser (KZJ120) | 3.0 | | 09.02 - | 1KD-FTV | | █ | Y-531J | 5467 | | D-POWER 44 | 5467 |
| Land Cruiser (KZJ90,95) | 2.8 | | 98 - | 3L | 4 | █ | Y-715R | 5376 | | | |
| Land Cruiser (LJ120,125) | 3.0 | | 09.02 - | 1KD-FTV | | █ | Y-531J | 5467 | | D-POWER 44 | 5467 |
| Land Cruiser (LJ90,95) | 2.8 | | 98 - | 3L | 4 | █ | Y-715R | 5376 | | | |
| Land Cruiser (RZJ120,125) | 2.7 | | 01.03 - | 3RZ-FE with 3way cat. | 4 | 1,1 | BKR5EYA-11 | 2526 | 39 | LPG 1 | 1496 |
| (GRJ120,125) | | | | | | | | | | | |
| Land Cruiser (RZJ120,125) | 2.7 | | 01.03 - | 3RZ-FE without 3way cat. | 4 | 0,8 | BKR5EYA | 2087 | | LPG 1 | 1496 |
| (GRJ120,125) | | | | | | | | | | | |
| Land Cruiser (RZJ120,125) | 4.0 | 183 | 02 - | 1GR-FE | 6 | 1,1 | LFR6C-11 | 5788 | | | |
| (GRJ120,125) | | | | | | | | | | | |
| Land Cruiser (RZJ90,95, VZJ90,95) | 2.7 | | 05.96 - | 3RZ-F | 6 | 0,8 | BKR5EYA | 2087 | | LPG 1 | 1496 |
| Land Cruiser (RZJ90,95, VZJ90,95) | 2.7 | | 05.96 - | 3RZ-FE | 6 | 0,8 | BKR5EYA | 2087 | | LPG 1 | 1496 |
| Land Cruiser (RZJ90,95, VZJ90,95) | 3.4 | 131 | 05.96 - | 5VZ-FE | 6 | | BKR5EKB-11 | 3967 | | | |
| Land Cruiser (TRJ120, 125) | 4.0 | | 01.05 - | 1GR-FE | 6 | 1,1 | LFR6C-11 | 5788 | | | |
| (GRJ120, 125) | | | | | | | | | | | |
| Land Cruiser (UZJ100) | 4.5 | | 98 - 12.99 | 1FZ-FE | 6 | | BKR5EKB-11 | 3967 | | | |
| Land Cruiser (UZJ100) | 4.5 | | 01.02 - | 1FZ-FE | 6 | | BKR5EKB-11 | 3967 | | | |
| Land Cruiser (UZJ100) | 4.7 | 173 | 01.98 - | 2UZ-FE | 8 | 1,1 | IFR6T11 | 4589 | | IFR6T11 | 4589 |
| Land Cruiser (UZJ100,FZJ100,105) | 4.5 | | 01.01 - | 1FZ-FE | 6 | | BKR5EKB-11 | 3967 | | | |
| Land Cruiser (UZJ100,FZJ100,105) | 4.7 | | 01.01 - | 2UZ-FE with 3way cat. | 8 | 1,1 | IFR6T11 | 4589 | | IFR6T11 | 4589 |
| Land Cruiser D4D | 3.0 | 120 | 02 - | 1KD-FTV | 4 | █ | Y-531J | 5467 | | D-POWER 44 | 5467 |
| Liteace | 1.3 | 42 | | 4K,4K-C | 4 | 0,8 | BPR5EA-L | 5823 | | | |
| Liteace | 1.6 | | 84 - 85 | 1Y | 4 | 0,8 | BPR5EY | 2828 | 9 | LPG 2 | 1497 |
| Liteace | 2.2 | | 93 - | 4Y-E | 4 | 1,1 | BPR5EP-11 | 3971 | | | |
| Liteace (KM30,36,37, YM30,35) | 1.8 | | 90 - | 2Y Cat. | 4 | 0,8 | BP5EY | 7327 | | LPG 2 | 1497 |
| Liteace (KM30,36,37, YM30,35) | 1.8 | | 90 - | 2Y-C Cat. | 4 | 1,1 | BPR5EP-11 | 3971 | | | |
| Liteace (KM30,36,37, YM30,35) | 1.8 | | 90 - | 2Y-CU Cat. | 4 | 0,8 | BP5EY | 7327 | | LPG 2 | 1497 |
| Liteace (KM30,36,37, YM30,35)) | 1.5 | 52 | 86 - 90 | 5K,5K-C | 4 | 0,8 | BPR5EY | 2828 | 9 | LPG 2 | 1497 |
| Liteace (KM30,36,37, YM30,35,40,41) | 1.8 | 57 | 86 - 88 | 2Y | 4 | 0,8 | BP5EY | 7327 | | LPG 2 | 1497 |
| Liteace (KM30,36,37, YM30,35,40,41) | 1.8 | 58 | 86 - 89 | 2Y-C Cat. | 4 | 1,1 | BPR5EP-11 | 3971 | | | |
| Liteace (KM30,36,37, YM30,35,40,41) | 1.8 | | 86 - 89 | 2Y Cat. | 4 | 1,1 | BPR5EP-11 | 3971 | | | |
| Liteace (KM30,36,37, YM30,35,40,41) | 1.8 | | 89 - | 2Y-C | 4 | 0,8 | BP5EY | 7327 | | LPG 2 | 1497 |
| Liteace (KM30,36,37, YM30,35,40,41) | 1.8 | | - 89 | 2Y-CU Cat. | 4 | 1,1 | BPR5EP-11 | 3971 | | | |
| Liteace (KM30,36,37, YM30,35,40,41) | 2.0 | | 93 - | 3Y | 4 | 0,8 | BP5EY | 7327 | | LPG 2 | 1497 |
| Liteace (KM30,36,37, YM30,35,40,41) | 2.0 | | | 3Y-CU | 4 | 1,1 | BPR5EP-11 | 3971 | | | |
| Liteace (KR41,42) | 1.5 | | 98 - | 5K | 4 | 0,8 | BPR5EY | 2828 | 9 | LPG 2 | 1497 |
| Liteace (KR41,42) | 1.8 | | 98 - | 7K | 4 | 0,8 | BPR5EY | 2828 | 9 | LPG 2 | 1497 |
| Liteace (KR41,42) | 2.0 | | 98 - | 3S-FE | 4 | | BKR6EKB-11 | 3583 | | | |
| Liteace (KR42,SR40) | 1.8 | | 01.00 - | 7K-E | 4 | 1,1 | BPR5EY-11 | 3028 | | LPG 2 | 1497 |
| Liteace (SR40) | 1.5 | | 98 - | 5K | 4 | 0,8 | BPR5EY | 2828 | 9 | LPG 2 | 1497 |
| Liteace (SR40) | 1.8 | | 98 - | 7K | 4 | 0,8 | BPR5EY | 2828 | 9 | LPG 2 | 1497 |
| Liteace (SR40) | 2.0 | | 98 - | 3S-FE | 4 | | BKR6EKB-11 | 3583 | | | |
| Liteace 2000 | 1.8 | | | 1C | 4 | █ | Y-146R | 7492 | | | |
| Liteace 2000 | 2.0 | | | 2C | 4 | █ | Y-703R | 3782 | | | |
| Model F | 1.8 | 57 | 11.82 - 08.84 | 2Y | 4 | 0,8 | BPR5EY | 2828 | 9 | LPG 2 | 1497 |
| Model F | 2.0 | | | 3Y-EC | 4 | 0,8 | BPR5EY | 2828 | 9 | LPG 2 | 1497 |
| Model F | 2.2 | | 90 - | 4Y-E | 4 | 0,8 | BPR5EY | 2828 | 9 | LPG 2 | 1497 |



ℓ kW



Cyl.

Order-
No. No.LPG/CNG
D-PowerOrder-
No.**TOYOTA**

| | | | | | | | | | | | | | |
|----------------------------------|-----|-----|---------------|---------|---------------|---|-----|------------|------|----|------------|------|--|
| Model F | 2.2 | | 08.85 - | 4Y-E | Cat. | 4 | 1,1 | BPR5EP-11 | 3971 | | | | |
| Model F | 2.2 | | 08.85 - | 4Y-EC | | 4 | 0,8 | BPR5EY | 2828 | 9 | LPG 2 | 1497 | |
| Model F (YR21,22,31) | 2.0 | 65 | 08.84 - 90 | 3Y | | 4 | 0,8 | BPR5EY | 2828 | 9 | LPG 2 | 1497 | |
| Model F (YR21,22,31) | 2.0 | 65 | | 3Y-C | | 4 | 0,8 | BPR5EY | 2828 | 9 | LPG 2 | 1497 | |
| Model F (YR21,22,31) | 2.0 | 65 | 08.84 - 88 | 3Y-C | Cat. | 4 | 1,1 | BPR5EP-11 | 3971 | | | | |
| Model F (YR21,22,31) | 2.2 | 73 | 08.85 - | 4Y-EC | Cat. | 4 | 1,1 | BPR5EP-11 | 3971 | | | | |
| Model F / Tarago | 2.0 | | | 2C | | 4 | █ | Y-146R | 7492 | | | | |
| MR 2 | 1.6 | | | 4A-GZE | | 4 | 1,1 | BCPR6EP-11 | 3350 | | LPG 3 | 1498 | |
| MR 2 | 2.2 | | 93 - | 5S-FE | | 4 | 1,1 | BKR6EP-11 | 2978 | | LPG 1 | 1496 | |
| MR 2 (AW11) | 1.6 | 85 | 86 - 90 | 4A-GE | Cat. | 4 | 1,1 | BCPR5EP-11 | 2097 | | LPG 3 | 1498 | |
| MR 2 (AW11) | 1.6 | 91 | 86 - 88 | 4A-GE | | 4 | 1,1 | BCPR6EY-11 | 3720 | | LPG 3 | 1498 | |
| MR 2 (SW20) | 2.0 | 115 | 90 - 93 | 3S-GE | Cat. | 4 | 0,8 | BKR6EP-8 | 2215 | | LPG 1 | 1496 | |
| MR 2 (SW20) | 2.0 | 118 | 89 - 92 | 3S-GE | | 4 | 0,8 | BKR6EYA | 2249 | | LPG 1 | 1496 | |
| MR 2 (SW20) | 2.0 | 129 | 94 - | 3S-GE | | 4 | 0,8 | BKR6EP-8 | 2215 | | LPG 1 | 1496 | |
| MR 2 (SW20) | 2.0 | | 93 - | 3S-GTE | | 4 | 0,8 | BKR6EP-8 | 2215 | | LPG 1 | 1496 | |
| MR 2 (SW20) | 2.2 | 89 | 90 - | 3S-FE | Cat. | 4 | 1,1 | BKR6EYA-11 | 4073 | | LPG 1 | 1496 | |
| MR 2 (ZZW30) | 1.8 | 103 | 12.99 - | 1ZZ-FE | | 4 | 1,1 | BKR5EYA-11 | 2526 | 39 | LPG 1 | 1496 | |
| Paseo (EL54) | 1.5 | 66 | 07.95 - 12.97 | 5E-FE | (only Europe) | 4 | 0,8 | BKR5EYA | 2087 | | LPG 1 | 1496 | |
| Paseo (EL54) | 1.5 | | 01.98 - 07.99 | 5E-FE | (only Europe) | 4 | 1,1 | BKR5EP-11 | 3440 | | LPG 1 | 1496 | |
| Pick-up | 2.2 | | 08.82 - | L | | 4 | █ | Y-118T1 | 2951 | | | | |
| Pick-up Super Glow System | 2.2 | | 08.82 - | L | | 4 | █ | Y-118R | 2187 | | | | |
| Picnic (ACM20) | 2.0 | 110 | 05.01 - | 1AZ-FE | | 4 | 1,1 | IFR6T11 | 4589 | | IFR6T11 | 4589 | |
| Picnic (SXM10) | 2.0 | 94 | 09.96 - 09.01 | 3S-FE | | 4 | | BKR6EKP-11 | 3452 | | | | |
| Previa (ACR30,50) | 2.4 | 115 | 03.00 - | 2AZ-FE | | 4 | 1,1 | IFR6T11 | 4589 | | IFR6T11 | 4589 | |
| Previa (TCR10,11,20,21) | 2.4 | 97 | 05.90 - 00 | 2TZ-FE | Cat. | 4 | 1,1 | BKR5EP-11 | 3440 | | LPG 1 | 1496 | |
| Previa (TCR10,11,20,21) | 2.4 | 97 | 05.90 - | 2TZ-FE | 3 way Cat. | 4 | 0,8 | BKR5EYA | 2087 | | LPG 1 | 1496 | |
| Previa (TCR10,11,20,21) | 2.4 | | 96 - | 2TZ-FE | without Cat. | 4 | 0,8 | BKR5EYA | 2087 | | LPG 1 | 1496 | |
| Previa 2.0 D | 2.0 | 85 | 04.01 - | 1CD-FTV | | 4 | █ | Y-531J | 5467 | | D-POWER 44 | 5467 | |
| Prius (NHW11) | 1.5 | 53 | 05.00 - 03 | 1NZ-FXE | | 4 | | IFR5T11 | 4996 | | IFR5T11 | 4996 | |
| Prius (NHW20) | 1.5 | 57 | 03 - 09 | 1NZ-FXE | | 4 | | IFR5T11 | 4996 | | IFR5T11 | 4996 | |
| Prius (ZVW30) | 1.8 | 72 | 04.09 - | 2ZR-FXE | | 4 | 1,1 | ILKAR7B11 | 4912 | | ILKAR7B11 | 4912 | |
| RAV 4 2.0 D | 2.0 | 85 | 10.01 - | 1CD-FTV | | 4 | █ | Y-531J | 5467 | | D-POWER 44 | 5467 | |
| RAV 4 (ACA 30,31, 33,38) | 2.0 | | 01.07 - | 1AZ-FE | | 4 | 1,1 | IFR6T11 | 4589 | | IFR6T11 | 4589 | |
| RAV 4 (ACA 30,31,33,38) | 2.4 | | 01.07 - | 2AZ-FE | | 4 | 1,1 | IFR6T11 | 4589 | | IFR6T11 | 4589 | |
| RAV 4 (ACA30, 33, 38) | 2.0 | | 11.05 - 01.07 | 1AZ-FE | | 4 | 1,1 | IFR6T11 | 4589 | | IFR6T11 | 4589 | |
| RAV 4 (ACA30, 33, 38) | 2.4 | | 11.05 - 01.07 | 2AZ-FE | | 4 | 1,1 | IFR6T11 | 4589 | | IFR6T11 | 4589 | |
| RAV 4 (ACA31W/36W) | 2.4 | | 11.05 - | 2AZ-FE | | 4 | 1,1 | IFR6T11 | 4589 | | IFR6T11 | 4589 | |
| RAV 4 (SXA10) | 2.0 | 95 | 94 - 97 | 3S-FE | | 4 | 1,1 | BKR6EYA-11 | 4073 | | LPG 1 | 1496 | |
| RAV 4 (SXA10,11) | 2.0 | | 98 - 00 | 3S-FE | | 4 | | BKR6EKP-11 | 3452 | | | | |
| RAV 4 (ZCA25,26, ACA20,21,22,23) | 1.8 | 92 | 05.00 - | 1ZZ-FE | | 4 | 1,1 | BKR5EYA-11 | 2526 | 39 | LPG 1 | 1496 | |
| RAV 4 (ZCA25,26, ACA20,21,22,23) | 2.0 | | 05.00 - | 1AZ-FE | | 4 | 1,1 | IFR6T11 | 4589 | | IFR6T11 | 4589 | |
| RAV 4 (ZCA25,26, ACA20,21,22,23) | 2.4 | | 01.04 - | 2AZ-FE | | 4 | 1,1 | IFR6T11 | 4589 | | IFR6T11 | 4589 | |
| RAV 4 (ZSA30 / ZSA35) | 2.0 | 116 | 12.08 - | 3ZRFAE | | 4 | 1,1 | ILKAR7B11 | 4912 | | ILKAR7B11 | 4912 | |
| Spacecruiser | 1.8 | | | 2Y | | 4 | 0,8 | BPR5EY | 2828 | 9 | LPG 2 | 1497 | |
| Spacecruiser | 2.0 | | | 3Y | | 4 | 0,8 | BPR5EY | 2828 | 9 | LPG 2 | 1497 | |
| Starlet | 1.2 | 39 | - 82 | 3K | | 4 | 0,8 | BPR5EA-L | 5823 | | | | |
| Starlet | 1.3 | 36 | - 84 | 4K | | 4 | 0,8 | BPR5EA-L | 5823 | | | | |
| Starlet | 1.3 | 55 | - 87 | 2E-C | | 4 | 1,1 | BPR6EY-11 | 4228 | 10 | LPG 2 | 1497 | |
| Starlet | 1.3 | 55 | 93 - | 4A-FE | | 4 | 1,1 | BKR5EYA-11 | 2526 | 39 | LPG 1 | 1496 | |
| Starlet | 1.3 | | 95 - | 2E-E | | 4 | 0,8 | BPR4EY | 2128 | | LPG 2 | 1497 | |
| Starlet | 1.5 | | 90 - 92 | 1N | | 4 | █ | Y-715R | 5376 | | | | |
| Starlet | 1.5 | | 93 - | 1N | | 4 | █ | Y-715R | 5376 | | | | |



ℓ kW

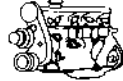

Cyl.

Order-
No. No.LPG/CNG
D-PowerOrder-
No.**TOYOTA**

| | | | | | | | | | | | |
|------------------------------------|-----|-----|---------------|------------|---|-----|------------|------|----|-----------|------|
| Starlet (EP70,EP71,EP76,EP80,EP81) | 1.0 | 40 | 85 - 92 | 1E | 4 | | BPR6EY | 6427 | | LPG 2 | 1497 |
| Starlet (EP70,71,76) | 1.3 | 53 | - 87 | 2E | 4 | 1,1 | BPR6EY-11 | 4228 | 10 | LPG 2 | 1497 |
| Starlet (EP70,71,76) | 1.3 | 55 | 88 - | 2E-C | 4 | 1,1 | BPR6EY-11 | 4228 | 10 | LPG 2 | 1497 |
| Starlet (EP80,81) | 1.3 | 53 | 88 - 92 | 2E | 4 | 1,1 | BPR5EY-11 | 3028 | | LPG 2 | 1497 |
| Starlet (EP80,81) | 1.3 | 53 | 93 - | 2E | 4 | 0,8 | BPR6EY | 6427 | | LPG 2 | 1497 |
| Starlet (EP80,81) | 1.3 | 55 | 90 - 12.95 | 2E-E Cat. | 4 | 0,8 | BPR5EY | 2828 | 9 | LPG 2 | 1497 |
| Starlet (EP80,81) | 1.3 | 55 | 02.96 - 03.97 | 4E-FE | 4 | 0,8 | BKR5EYA | 2087 | | LPG 1 | 1496 |
| Starlet (EP90,91) | 1.3 | 55 | 98 - 99 | 4E-FE | 4 | 0,8 | BKR5EYA | 2087 | | LPG 1 | 1496 |
| Starlet (EP90,91) | 1.3 | | 98 - | 2E | 4 | 0,8 | BPR6EY | 6427 | | LPG 2 | 1497 |
| Starlet (P7) | 1.5 | 40 | 12.86 - 11.89 | 1N | 4 | █ | Y-118R | 2187 | | | |
| Supra | 2.8 | | | 5M-GE | 6 | 0,8 | BPR6EY | 6427 | | LPG 2 | 1497 |
| Supra (JZA80) | 3.0 | 165 | 93 - 94 | 2JZ-GE | 6 | 1,1 | BKR5EP-11 | 3440 | | LPG 1 | 1496 |
| Supra (JZA80) | 3.0 | | 95 - 95 | 2JZ-GE | 6 | 1,1 | BKR6EP-11 | 2978 | | LPG 1 | 1496 |
| Supra (JZA80) | 3.0 | | 96 - | 2JZ-GE | 6 | 0,8 | BKR6EYA | 2249 | | LPG 1 | 1496 |
| Supra (JZA80) | 3.0 | | 95 - | 2JZ-GTE | 6 | 1,1 | BKR6EP-11 | 2978 | | LPG 1 | 1496 |
| Supra (MA70) | 3.0 | 150 | 86 - 88 | 7M-GE | 6 | 0,9 | BCPR6EY | 1146 | | LPG 3 | 1498 |
| Supra (MA70) | 3.0 | 150 | 87 - 89 | 7M-GE Cat. | 6 | 1,1 | BCPR5EP-11 | 2097 | | LPG 3 | 1498 |
| Supra (MA70) | 3.0 | | 90 - 92 | 7M-GE | 6 | 0,9 | BCPR6EY | 1146 | | LPG 3 | 1498 |
| Supra Turbo (MA70) | 3.0 | 175 | 87 - 92 | 7M-GTE | 6 | 0,8 | BCPR6EPN-8 | 5275 | | LPG 3 | 1498 |
| Supra V6 Biturbo (JZA80) | 3.0 | 243 | 93 - 94 | 2JZ-GTE | 6 | 1,1 | BKR6EP-11 | 2978 | | LPG 1 | 1496 |
| Tagora TD | | 59 | 09.81 - 06.83 | | 4 | █ | Y-924J | 7906 | | D-POWER 1 | 7906 |
| Tamarrow | 2.2 | | 08.82 - 08.83 | L | 4 | █ | Y-118T1 | 2951 | | | |
| Tamarrow Super Glow System | 2.2 | | 08.82 - 08.83 | L | 4 | █ | Y-118R | 2187 | | | |
| Tarago | 2.4 | 97 | 90 - | 2TZ-FE | 4 | 1,1 | BKR5EP-11 | 3440 | | LPG 1 | 1496 |
| Targo (ACR30) | 2.4 | | 03.00 - | 2AZ-FE | 4 | 1,1 | IFR6T11 | 4589 | | IFR6T11 | 4589 |
| Tercel | 1.3 | 48 | - 82 | 2A | 4 | 0,8 | BPR5EA-L | 5823 | | | |
| Tercel | 1.3 | 48 | 82 - 84 | 2A | 4 | 0,8 | BPR5EY | 2828 | 9 | LPG 2 | 1497 |
| Tercel | 1.5 | 50 | 86 - 88 | 3A-C | 4 | 0,8 | BPR5EY | 2828 | 9 | LPG 2 | 1497 |
| Tercel | 1.5 | 52 | 81 - 91 | 3A | 4 | 0,8 | BPR5EA-L | 5823 | | | |
| Tercel | 1.5 | | 93 - | 3E-E | 4 | 1,1 | BPR5EY-11 | 3028 | | LPG 2 | 1497 |
| Tercel (AL25) | 1.5 | 50 | 88 - | 3A-C Cat. | 4 | 1,1 | BPR5EY-11 | 3028 | | LPG 2 | 1497 |
| Tercel (AL25) | 1.5 | 52 | 82 - 87 | 3A | 4 | 0,8 | BPR5EY | 2828 | 9 | LPG 2 | 1497 |
| Tercel (EL50,53) | 1.3 | | 98 - | 2E | 4 | 0,8 | BPR6EY | 6427 | | LPG 2 | 1497 |
| Tercel (EL50,53) | 1.5 | | 98 - | 5E-FE | 4 | | BKR5EKB-11 | 3967 | | | |
| Townace (KR41,42) | 1.5 | | 98 - | 5K | 4 | 0,8 | BPR5EY | 2828 | 9 | LPG 2 | 1497 |
| Townace (KR41,42) | 1.8 | | 98 - | 7K | 4 | 0,8 | BPR5EY | 2828 | 9 | LPG 2 | 1497 |
| Townace (KR41,42) | 2.0 | | 98 - | 3S-FE | 4 | | BKR6EKB-11 | 3583 | | | |
| Townace (SR40) | 1.5 | | 98 - | 5K | 4 | 0,8 | BPR5EY | 2828 | 9 | LPG 2 | 1497 |
| Townace (SR40) | 1.8 | | 98 - | 7K | 4 | 0,8 | BPR5EY | 2828 | 9 | LPG 2 | 1497 |
| Townace (SR40) | 2.0 | | 98 - | 3S-FE | 4 | | BKR6EKB-11 | 3583 | | | |
| Townace (KR42,SR40) | 1.8 | | 01.00 - | 7K-E | 4 | 1,1 | BPR5EY-11 | 3028 | | LPG 2 | 1497 |
| Toyo-Ace | | | 08.80 - 01.82 | 2J | | █ | Y-147T | 7493 | | | |
| Toyo-Ace | | | 08.80 - 01.82 | 2J | | █ | Y-197T | 2190 | | | |
| Toyo-Ace | | | 01.82 - | 2L | | █ | Y-197R | 2188 | | | |
| Toyo-Ace | | | 09.83 - | 2L | | █ | Y-168R | 2162 | | | |
| Toyo-Ace | | | 09.83 - | 2L | | █ | Y-118R | 2187 | | | |
| Toyo-Ace | 2.2 | | 08.80 - 01.82 | L | 4 | █ | Y-197T | 2190 | | | |
| Toyo-Ace | 3.0 | | 01.82 - | B | 4 | █ | Y-197R | 2188 | | | |
| Toyo-Ace | 3.0 | | 09.80 - 01.82 | B | 4 | █ | Y-197T | 2190 | | | |
| Toyo-Ace | 3.0 | | 09.80 - 01.82 | B | 4 | █ | Y-147T | 7493 | | | |
| Toyo-Ace Super Glow System | | | 09.83 - | 2L | | █ | Y-118R | 2187 | | | |
| Urban Cruiser 1.3 (NSP110) | 1.3 | 74 | 01.09 - | 1NRFE | 4 | | ILKAR7B11 | 4912 | | ILKAR7B11 | 4912 |



l kW



Cyl.

Order-
No. No.LPG/CNG
D-PowerOrder-
No.**TOYOTA**

| | | | | | | | | | | | |
|--|-----|-----|---------------|--------|---|-----|------------|------|----|------------|------|
| Urban Cruiser 1.4 D-4D (NSP110) | 1.4 | 66 | 01.09 - | 1ND-TV | 4 | █ | Y-542J | 5513 | | D-POWER 45 | 5513 |
| Verso (ZGR20) | 1.6 | 81 | 04.09 - | 1ZRFAE | 4 | 1,1 | ILKAR7B11 | 4912 | | ILKAR7B11 | 4912 |
| Verso (ZGR20) | 1.6 | 97 | 04.09 - | 1ZRFAE | 4 | 1,1 | ILKAR7B11 | 4912 | | ILKAR7B11 | 4912 |
| Verso (ZGR21) | 1.8 | 95 | 04.09 - | 2ZRFAE | 4 | 1,1 | ILKAR7B11 | 4912 | | ILKAR7B11 | 4912 |
| Verso (ZGR21) | 1.8 | 108 | 04.09 - | 2ZRFAE | 4 | 1,1 | ILKAR7B11 | 4912 | | ILKAR7B11 | 4912 |
| Yaris 1.0 (SCP90, NCP90; 91 ZSP90) | 1.0 | | 11.05 - | 1KR-FE | 3 | 1,1 | LFR6C-11 | 5788 | | | |
| Yaris 1.0 (KSP90) VVTI | 1.0 | 51 | 08.05 - | 1KR-FE | 3 | 1,1 | LFR6C-11 | 5788 | | | |
| Yaris 1.0 (NCP90,91) VVTI | 1.0 | 51 | 08.05 - | 1KR-FE | 3 | 1,1 | LFR6C-11 | 5788 | | | |
| Yaris 1.0 16V(NCP10,11,12,13) | 1.0 | 48 | 01.99 - | 1SZ-FE | 4 | 0,8 | BKR5EYA | 2087 | | LPG 1 | 1496 |
| Yaris 1.0 16V(SCP10) | 1.0 | 48 | 01.01 - | 1SZ-FE | 4 | 1,1 | BKR6EYA-11 | 4073 | | LPG 1 | 1496 |
| France production | | | | | | | | | | | |
| Yaris 1.0 16V(SCP10) | 1.0 | 48 | 01.99 - | 1SZ-FE | 4 | 0,8 | BKR5EYA | 2087 | | LPG 1 | 1496 |
| Japan production | | | | | | | | | | | |
| Yaris 1.3 (KSP90)(ZSP90) VVTI | 1.3 | 64 | 08.05 - 11.06 | 2NZ-FE | 4 | 1,1 | BKR5EYA-11 | 2526 | 39 | LPG 1 | 1496 |
| Yaris 1.3 (KSP90)(SCP90) | 1.3 | | 11.05 - | 2SZ-FE | 4 | 0,8 | BKR5EYA | 2087 | | LPG 1 | 1496 |
| Yaris 1.3 (NCP90,91) VVTI | 1.3 | 64 | 08.05 - 11.06 | 2NZ-FE | 4 | 1,1 | BKR5EYA-11 | 2526 | 39 | LPG 1 | 1496 |
| Yaris 1.3 (NCP 92, 93) | 1.3 | | 01.06 - | 2NZ-FE | 4 | 1,1 | BKR5EYA-11 | 2526 | 39 | LPG 1 | 1496 |
| Yaris 1.3 (NCP10,11,12,13) (SCP10,12) | 1.3 | 64 | 04.02 - | 2SZ-FE | 4 | 0,8 | BKR5EYA | 2087 | | LPG 1 | 1496 |
| Yaris 1.3 16V(NCP10,11,12,13) (SCP10) | 1.3 | 63 | 01.01 - | 2NZ-FE | 4 | 1,1 | BKR5EYA-11 | 2526 | 39 | LPG 1 | 1496 |
| Yaris 1.4 D-4D | 1.4 | 66 | 02.06 - | | 4 | █ | Y-542J | 5513 | | D-POWER 45 | 5513 |
| Yaris 1.4 D-4D (NLP10) | 1.4 | 55 | 12.01 - | 1ND-TV | 4 | █ | Y-542J | 5513 | | D-POWER 45 | 5513 |
| Yaris 1.4 (NLP90) | 1.4 | 55 | 11.05 - | 1ND-TV | 4 | █ | Y-542J | 5513 | | D-POWER 45 | 5513 |
| Yaris 1.5 (KSP90)(ZSP90) | 1.5 | 78 | 08.05 - 11.06 | 1NZ-FE | 4 | 0,8 | BKR5EYA | 2087 | | LPG 1 | 1496 |
| Yaris 1.5 (NCP10,11,12,13)(SCP10) | 1.5 | 78 | 01.01 - 12.01 | 1NZ-FE | 4 | 1,1 | BKR5EYA-11 | 2526 | 39 | LPG 1 | 1496 |
| Yaris 1.5 (NCP20, 21, 22) | 1.5 | 78 | 01.02 - | 1NZ-FE | 4 | 0,8 | BKR5EYA | 2087 | | LPG 1 | 1496 |
| Yaris 1.5 (NCP90,91) | 1.5 | 78 | 02.06 - 11.06 | 1NZ-FE | 4 | 0,8 | BKR5EYA | 2087 | | LPG 1 | 1496 |
| Yaris 1.5 (NCP92, 93) | 1.5 | | 01.06 - | 1NZ-FE | 4 | 0,8 | BKR5EYA | 2087 | | LPG 1 | 1496 |
| Yaris 1.5TS (NCP10,11,12,13)(SCP10) | 1.5 | 78 | 01.02 - | 1NZ-FE | 4 | 0,8 | BKR5EYA | 2087 | | LPG 1 | 1496 |
| Yaris TS (ZSP90) | 1.8 | 97 | 11.06 - | 2ZR-FE | 4 | 1,1 | ILKAR7B11 | 4912 | | ILKAR7B11 | 4912 |
| Yaris Verso (NCP20,21,22) | 1.3 | 63 | 08.99 - | 2NZ-FE | 4 | 1,1 | BKR5EYA-11 | 2526 | 39 | LPG 1 | 1496 |
| Yaris Verso (NCP20,21,22) | 1.5 | 78 | 01 - 12.00 | 1NZ-FE | 4 | 1,1 | BKR5EYA-11 | 2526 | 39 | LPG 1 | 1496 |

TRABANT

| | | | | | | | | | | | |
|-----|-----|----|---------------|----------|---|-----|-------|------|---|-------|------|
| 601 | 1.1 | 29 | 05.90 - 12.91 | VW-Motor | 4 | 0,7 | BP6ES | 7811 | 4 | LPG 2 | 1497 |
|-----|-----|----|---------------|----------|---|-----|-------|------|---|-------|------|

TRIUMPH

| | | | | | | | | | | | |
|---------|-----|----|---------------|--|---|-----|--------|------|---|-------|------|
| Acclaim | 1.3 | 51 | 10.81 - 06.84 | | 4 | 0,9 | BPR5ES | 7422 | 6 | LPG 2 | 1497 |
|---------|-----|----|---------------|--|---|-----|--------|------|---|-------|------|

TVR

| | | | | | | | | | | | |
|----------|-----|-----|---------|------------------|---|-----|---------|------|---|-------|------|
| 280 i | 2.8 | | | | 6 | 0,8 | BPR6ES | 7822 | 2 | LPG 2 | 1497 |
| 280 s | 2.8 | | | | 6 | 0,8 | BPR6ES | 7822 | 2 | LPG 2 | 1497 |
| 290 i | 2.9 | | | | 6 | 0,8 | BPR6ES | 7822 | 2 | LPG 2 | 1497 |
| 350 i | 3.5 | | | | 8 | 0,8 | BPR6ES | 7822 | 2 | LPG 2 | 1497 |
| 400 | 4.0 | | | | 8 | 0,8 | B7ECS | 2528 | | | |
| 450 | 4.5 | | | | 8 | 0,8 | B7ECS | 2528 | | | |
| Cerbera | 4.0 | | 09.98 - | IL6 4.0L | 6 | 0,9 | DCPR8E | 4339 | | LPG 8 | 6806 |
| Cerbera | 4.2 | 306 | 95 - | AJP (TVR engine) | 8 | | BKR5EKU | 3964 | | | |
| Chimaera | 4.0 | | | V8 Rover | 8 | 0,8 | B7ECS | 2528 | | | |
| Chimaera | 4.3 | | | V8 Rover | 8 | 0,8 | B7ECS | 2528 | | | |
| Chimaera | 5.0 | | | V8 Rover | 8 | 0,8 | B7ECS | 2528 | | | |



ℓ kW



Cyl.

Order-
No. No.LPG/CNG
D-PowerOrder-
No.**TVR**

| | | | | | | | | | | | | |
|------------------|-----|--|---------|-----------|---|-----|---------|------|----|-------|--|------|
| Griffith | 3.9 | | | | 8 | 0,8 | B7ECS | 2528 | | | | |
| Griffith | 4.3 | | | | 8 | 0,8 | B7ECS | 2528 | | | | |
| Griffith | 4.5 | | | | 8 | 0,8 | B7ECS | 2528 | | | | |
| Griffith 500 | 5.0 | | 95 - | V8 Rover | 8 | 0,8 | B7ECS | 2528 | | | | |
| S2 | | | | | 6 | 0,8 | BCPR6ES | 2330 | 12 | LPG 3 | | 1498 |
| S3 | | | | non Cat. | 6 | 0,8 | BCPR6ES | 2330 | 12 | LPG 3 | | 1498 |
| S3 | | | | With Cat. | 6 | 1,0 | BPR6EFS | 3623 | 7 | LPG 5 | | 1516 |
| S3C | 2.9 | | | | 6 | 1,0 | BPR6EFS | 3623 | 7 | LPG 5 | | 1516 |
| Speed | 3.9 | | | 39 | 8 | 0,8 | B7ECS | 2528 | | | | |
| Speed | 4.3 | | | 43 | 8 | 0,8 | B7ECS | 2528 | | | | |
| Tamora | 3.6 | | | IL6 | 6 | 0,9 | DCPR8E | 4339 | | LPG 8 | | 6806 |
| Tasmin | 2.0 | | | | 4 | 0,6 | APR6FS | 2922 | | | | |
| Tasmin | 2.8 | | | | 6 | 0,8 | BCPR6ES | 2330 | 12 | LPG 3 | | 1498 |
| Tuscan | 3.5 | | | | 8 | 0,9 | BPR5ES | 7422 | 6 | LPG 2 | | 1497 |
| Tuscan Speed Six | 4.0 | | 09.98 - | | 6 | 0,9 | DCPR8E | 4339 | | LPG 8 | | 6806 |

UAZ

| | | | | | | | | | | | | |
|---|-----|----|---------|---------|---|-----|--------|------|----|-----------|--|------|
| 31512, 31514 | 2.3 | 73 | | 3M3-402 | 4 | 0,6 | BP6HS | 4511 | 18 | BPR7HIX | | 5944 |
| 31512, 31514, 31516, 31519 | | | | | 4 | 0,6 | B5HS | 4210 | | | | |
| 3159 Bars | | | | | 4 | 0,9 | BPR5ES | 7422 | 6 | LPG 2 | | 1497 |
| 3303, 3714, 3153, 3741, 3909, 3962, 3221 | | | | | 4 | 0,6 | B5HS | 4210 | | | | |
| 425 PP Promiscuo D | | | 08.81 - | Peugeot | 4 | █ | Y-924J | 7906 | | D-POWER 1 | | 7906 |
| 469 B D | 2.5 | | -11.85 | Peugeot | 4 | █ | Y-924J | 7906 | | D-POWER 1 | | 7906 |
| 469 B TD | 2.4 | | -04.86 | VM | 4 | █ | Y-909R | 4602 | | | | |

VAZ-GM

| | | | | | | | | | | | | |
|---------------------|-----|----|---------|----------|---|-----|-----------|------|----|-------|--|------|
| Chevrolet Niva 1.7i | 1.7 | 60 | 01.02 - | VAZ-2121 | 4 | 1,1 | BPR6ES-11 | 4824 | 13 | LPG 2 | | 1497 |
|---------------------|-----|----|---------|----------|---|-----|-----------|------|----|-------|--|------|

VOLVO

| | | | | | | | | | | | | |
|-------------|-----|-----|---------------|---------------------|---|-----|---------|------|---|------------|--|------|
| 240 | 2.0 | 72 | 08.84 - 07.89 | B200K | 4 | 0,7 | BP6ES | 7811 | 4 | LPG 2 | | 1497 |
| 240 | 2.3 | 78 | 08.84 - 07.86 | B230K | 4 | 0,7 | BP6ES | 7811 | 4 | LPG 2 | | 1497 |
| 240 | 2.3 | 78 | 08.86 - 07.90 | B230K | 4 | 0,8 | BPR6ES | 7822 | 2 | LPG 2 | | 1497 |
| 240i | 2.0 | 77 | 08.88 - 08.92 | | 4 | 0,8 | BPR6ES | 7822 | 2 | LPG 2 | | 1497 |
| 240i | 2.0 | 86 | 08.84 - 07.87 | B200E | 4 | 0,7 | BP6ES | 7811 | 4 | LPG 2 | | 1497 |
| 240i | 2.0 | 86 | 08.87 - 07.92 | B200E | 4 | 0,8 | BPR6ES | 7822 | 2 | LPG 2 | | 1497 |
| 240i | 2.3 | 85 | 08.84 - 08.93 | B230F Cat. | 4 | 0,8 | BPR6ES | 7822 | 2 | LPG 2 | | 1497 |
| 240i | 2.3 | 96 | 08.87 - 07.92 | B230E | 4 | 0,8 | BPR6ES | 7822 | 2 | LPG 2 | | 1497 |
| 240i | 2.3 | | 08.92 - | B230FD | 4 | 0,8 | BPR6ES | 7822 | 2 | LPG 2 | | 1497 |
| 240i / 260i | 2.8 | 114 | 08.80 - 07.84 | B28E | 6 | 1,0 | BPR6EFS | 3623 | 7 | LPG 5 | | 1516 |
| 300 Series | 1.4 | | 80 - 83 | B14.1, B14.2, B14.3 | 4 | 0,8 | BP5E | 4669 | 8 | BPR5EIX | | 6597 |
| 300 Series | 2.0 | | 80 - 83 | B19A | 4 | 0,8 | BP5E | 4669 | 8 | BPR5EIX | | 6597 |
| 340 | 1.4 | 47 | 08.84 - | B14 | 4 | 0,8 | BPR6ES | 7822 | 2 | LPG 2 | | 1497 |
| 340 | 1.7 | 61 | 07.85 - 07.91 | B172K | 4 | 0,8 | BPR6ES | 7822 | 2 | LPG 2 | | 1497 |
| 340 / 340i | 2.0 | 82 | 08.82 - 07.88 | B200E/B200K | 4 | 0,8 | BPR6ES | 7822 | 2 | LPG 2 | | 1497 |
| 340 / 360 | 2.0 | 65 | -07.84 | B19A | 4 | 0,7 | BP6ES | 7811 | 4 | LPG 2 | | 1497 |
| 340 D | 1.6 | 40 | 09.84 - 07.91 | D 16 | 4 | █ | Y-913M | 3965 | | D-POWER 15 | | 5317 |
| 360 / 360i | 2.0 | 72 | 08.82 - 07.89 | B19E/B200E | 4 | 0,8 | BPR6ES | 7822 | 2 | LPG 2 | | 1497 |
| 360 / 360i | 2.0 | 72 | 08.82 - 07.90 | B200K/B200F Cat. | 4 | 0,8 | BPR6ES | 7822 | 2 | LPG 2 | | 1497 |
| 360 D | 1.6 | | 07.84 - | D 16 | 4 | █ | Y-913M | 3965 | | D-POWER 15 | | 5317 |
| 440 | 1.7 | 58 | 09.88 - 12.96 | B18K/B Cat. | 4 | 0,8 | BPR6ES | 7822 | 2 | LPG 2 | | 1497 |
| 440 | 1.7 | 58 | 09.89 - 12.91 | B18KD Cat. | 4 | 0,7 | ZGR5B | 7345 | | | | |



l kW



Cyl.

Order-
No. No.LPG/CNG
D-PowerOrder-
No.**VOLVO**

| | | | | | | | | | | | | |
|------------------------|-----|-----|---------------|-------------------|---|-----|---------|------|----|--|------------|------|
| 440 | 1.7 | 64 | 09.88 - 02.92 | B18KPD Cat. | 4 | 0,7 | ZGR5B | 7345 | | | | |
| 440 TD | 1.9 | 66 | 01.93 - 12.96 | Renault F8Q Turbo | 4 | █ | Y-933J | 7947 | | | D-POWER 25 | 7947 |
| 440i | 1.6 | 62 | 02.92 - 12.95 | B16F Cat. | 4 | 0,7 | ZGR5B | 7345 | | | | |
| 440i | 1.7 | 70 | 09.88 - 03.92 | B18F Cat. | 4 | 0,7 | ZGR5B | 7345 | | | | |
| 440i | 1.7 | 75 | 09.89 - 12.96 | B18FP Cat. | 4 | 0,7 | ZGR5B | 7345 | | | | |
| 440i | 1.7 | 78 | 09.88 - 12.89 | B18ED Cat. | 4 | 0,8 | BPR7ES | 2023 | 19 | | BPR8EIX | 6684 |
| 440i | 1.7 | 88 | 09.88 - 07.96 | B18FTM/FT Cat. | 4 | 0,8 | BPR7ES | 2023 | 19 | | BPR8EIX | 6684 |
| 440i | 1.8 | 66 | 09.91 - 07.96 | B18U Cat. | 4 | 0,7 | ZGR5B | 7345 | | | | |
| 440i | 1.8 | 69 | 09.91 - 12.95 | B18 u. Cat. | 4 | 0,8 | BPR6ES | 7822 | 2 | | LPG 2 | 1497 |
| 440i | 2.0 | 81 | 08.92 - 07.95 | B20F Cat. | 4 | 0,8 | BPR7ES | 2023 | 19 | | BPR8EIX | 6684 |
| 440i | 2.0 | 81 | 09.92 - | B20U Cat. | 4 | 0,8 | BPR7ES | 2023 | 19 | | BPR8EIX | 6684 |
| 460 | 1.7 | 64 | 01.90 - 09.91 | B18KPD Cat. | 4 | 0,7 | ZGR5B | 7345 | | | | |
| 460 / 460i | 1.7 | 66 | 03.90 - 12.95 | B18KP/EP/ Cat | 4 | 0,8 | BPR6ES | 7822 | 2 | | LPG 2 | 1497 |
| 460 TD | 1.9 | 66 | 06.94 - 08.97 | D 19 T | 4 | █ | Y-933J | 7947 | | | D-POWER 25 | 7947 |
| 460i | 1.7 | 75 | 01.90 - 09.92 | B18FP Cat. | 4 | 0,7 | ZGR5B | 7345 | | | | |
| 460i | 1.7 | 88 | 01.90 - 12.95 | B18FT Cat. | 4 | 0,8 | BPR7ES | 2023 | 19 | | BPR8EIX | 6684 |
| 460i | 1.8 | 66 | 09.91 - 12.95 | B18U Cat. | 4 | 0,7 | ZGR5B | 7345 | | | | |
| 460i | 1.8 | 69 | 09.91 - 12.95 | B18 u. Cat. | 4 | 0,8 | BPR6ES | 7822 | 2 | | LPG 2 | 1497 |
| 460i | 2.0 | 81 | 09.92 - 12.95 | B20F Cat. | 4 | 0,8 | BPR7ES | 2023 | 19 | | BPR8EIX | 6684 |
| 480 | 1.7 | 78 | 04.86 - 07.89 | B18E | 4 | 0,8 | BPR7ES | 2023 | 19 | | BPR8EIX | 6684 |
| 480i | 1.7 | 70 | 09.87 - 03.90 | B18F Cat. | 4 | 0,7 | ZGR5B | 7345 | | | | |
| 480i | 1.7 | 75 | 10.89 - 09.92 | B18FP Cat. | 4 | 0,7 | ZGR5B | 7345 | | | | |
| 480i | 1.7 | 78 | 10.87 - 08.88 | B18ED Cat. | 4 | 0,8 | BPR7ES | 2023 | 19 | | BPR8EIX | 6684 |
| 480i | 1.7 | 88 | 03.88 - 07.96 | B18FT Cat. | 4 | 0,8 | BPR7ES | 2023 | 19 | | BPR8EIX | 6684 |
| 480i | 2.0 | 81 | 09.92 - 12.95 | B20F Cat. | 4 | 0,8 | BPR7ES | 2023 | 19 | | BPR8EIX | 6684 |
| 740 | 2.0 | 76 | 08.84 - 07.89 | B200K | 4 | 0,8 | BPR6ES | 7822 | 2 | | LPG 2 | 1497 |
| 740 / 740i | 2.3 | 80 | 08.83 - 07.87 | B23E/B230K/A | 4 | 0,7 | BP6ES | 7811 | 4 | | LPG 2 | 1497 |
| 740 D | 2.4 | 60 | 04.84 - 07.92 | D 24 | 6 | █ | Y-918J | 6285 | | | D-POWER 2 | 6285 |
| 740 TD | 2.4 | 80 | 04.87 - 07.92 | D 24 T | 6 | █ | Y-918J | 6285 | | | D-POWER 2 | 6285 |
| 740 TD (air condition) | 2.4 | 85 | 08.87 - 07.92 | D 24 TIC | 6 | █ | Y-918J | 6285 | | | D-POWER 2 | 6285 |
| 740i | 2.0 | 76 | 08.83 - 07.91 | B19E/B200E | 4 | 0,8 | BPR6ES | 7822 | 2 | | LPG 2 | 1497 |
| 740i | 2.0 | 82 | 08.89 - 07.91 | B200F Cat. | 4 | 0,8 | BPR6ES | 7822 | 2 | | LPG 2 | 1497 |
| 740i | 2.3 | 80 | 08.86 - 07.90 | B230K | 4 | 0,8 | BPR6ES | 7822 | 2 | | LPG 2 | 1497 |
| 740i | 2.3 | 85 | 08.87 - 07.95 | B230F Cat. | 4 | 0,8 | BPR6ES | 7822 | 2 | | LPG 2 | 1497 |
| 740i | 2.3 | 96 | 08.84 - 07.92 | B230E/B230F Cat. | 4 | 0,8 | BPR6ES | 7822 | 2 | | LPG 2 | 1497 |
| 740i 16V | 2.3 | 111 | 04.88 - 08.92 | B234F Cat. | 4 | 0,8 | BPR6ES | 7822 | 2 | | LPG 2 | 1497 |
| 740i 16V (I) | 2.0 | 76 | 08.88 - 07.91 | B204E | 4 | 0,8 | BPR6ES | 7822 | 2 | | LPG 2 | 1497 |
| 740i Turbo | 2.0 | 105 | 08.86 - 07.92 | B200ET/FT Cat. | 4 | 0,8 | BPR6ES | 7822 | 2 | | LPG 2 | 1497 |
| 740i Turbo | 2.0 | 110 | 04.84 - 08.86 | B19ET/B200ET | 4 | 0,7 | BP6ES | 7811 | 4 | | LPG 2 | 1497 |
| 740i Turbo | 2.3 | 114 | 08.86 - 07.91 | B230FT Cat. | 4 | 0,8 | BPR6ES | 7822 | 2 | | LPG 2 | 1497 |
| 740i Turbo | 2.3 | 130 | 08.84 - 08.86 | B230ET | 4 | 0,7 | BP6ES | 7811 | 4 | | LPG 2 | 1497 |
| 740i Turbo | 2.3 | 130 | 08.86 - 07.89 | B230ET | 4 | 0,8 | BPR6ES | 7822 | 2 | | LPG 2 | 1497 |
| 760 | 2.8 | 96 | 08.82 - 07.86 | B28A | 6 | 1,0 | BPR6EFS | 3623 | 7 | | LPG 5 | 1516 |
| 760 TD | 2.4 | 80 | 08.82 - 07.87 | D 24 T | 6 | █ | Y-918J | 6285 | | | D-POWER 2 | 6285 |
| 760 TD | 2.4 | 85 | 08.87 - 07.92 | D 24 TIC | 6 | █ | Y-918J | 6285 | | | D-POWER 2 | 6285 |
| 760i | 2.8 | 100 | 08.82 - 08.91 | B28F/B280F Cat. | 6 | 1,0 | BPR6EFS | 3623 | 7 | | LPG 5 | 1516 |
| 760i | 2.8 | 115 | 02.82 - 04.86 | B28E | 6 | 1,0 | BPR6EFS | 3623 | 7 | | LPG 5 | 1516 |
| 760i / 780i | 2.8 | 108 | 05.86 - 07.91 | B280E | 6 | 0,6 | BP7EFS | 3526 | | | | |
| 760i Turbo | 2.0 | 120 | 08.84 - 07.87 | B200ET | 4 | 0,7 | BP6ES | 7811 | 4 | | LPG 2 | 1497 |
| 760i Turbo | 2.0 | 120 | 08.87 - 07.89 | B200ET | 4 | 0,8 | BPR6ES | 7822 | 2 | | LPG 2 | 1497 |
| 760i Turbo | 2.3 | 114 | 08.84 - 07.92 | B230ET/FT Cat. | 4 | 0,8 | BPR6ES | 7822 | 2 | | LPG 2 | 1497 |
| 760i Turbo | 2.3 | 127 | 04.83 - 07.84 | B23ET | 4 | 0,7 | BP6ES | 7811 | 4 | | LPG 2 | 1497 |



ℓ kW

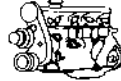

Cyl.

Order-
No.VLINE
No.LPG/CNG
D-PowerOrder-
No.**VOLVO**

| | | | | | | | | | | | |
|-----------------------------|-----|-----|---------------|---------------|---|-----|---------|------|----|------------|------|
| 780 TD | 2.4 | 85 | 08.85 - | D 24 TIC | 6 | █ | Y-918J | 6285 | | D-POWER 2 | 6285 |
| 780i | 2.8 | 108 | 05.86 - 07.91 | B280F Cat. | 6 | 1,0 | BPR6EFS | 3623 | 7 | LPG 5 | 1516 |
| 780i Turbo | 2.0 | 120 | 01.86 - 07.87 | B200ET | 4 | 0,7 | BP6ES | 7811 | 4 | LPG 2 | 1497 |
| 780i Turbo / 16V / Interco. | 2.0 | 120 | 08.87 - 07.90 | B200ET/B204GT | 4 | 0,8 | BPR6ES | 7822 | 2 | LPG 2 | 1497 |
| 850 | 2.0 | 93 | 08.94 - 12.96 | B5202S | 5 | 0,8 | BCPR6ES | 2330 | 12 | LPG 3 | 1498 |
| 850 R | 2.3 | 184 | 08.95 - 12.96 | B5234T | 5 | 0,8 | BKR7EVX | 3544 | | BKR8EIX | 2668 |
| 850 T | 2.0 | 154 | 02.93 - 12.96 | B5204T | 5 | 0,8 | BCPR6ES | 2330 | 12 | LPG 3 | 1498 |
| 850 T5 R | 2.3 | 177 | 94 - | B5234T5 | 5 | 0,8 | BKR7EVX | 3544 | | BKR8EIX | 2668 |
| 850 TDi | 2.5 | 103 | | D5252 (Audi) | 5 | █ | Y-732J | 5605 | | D-POWER 4 | 5605 |
| 850i | 2.0 | 96 | 09.91 - 12.96 | B5204F | 5 | 0,8 | BCPR6ES | 2330 | 12 | LPG 3 | 1498 |
| 850i | 2.5 | 103 | 10.92 - 07.94 | B5252S | 5 | 0,8 | BKR6ES | 3783 | 28 | LPG 1 | 1496 |
| 850i | 2.5 | 125 | 09.91 - 12.96 | B5254F | 5 | 0,8 | BKR6ES | 3783 | 28 | LPG 1 | 1496 |
| 850i T5 | 2.3 | 166 | 04.94 - 12.96 | B5234FT | 5 | 0,6 | BCP7EVX | 7681 | | BCPR7EIX | 5690 |
| 940 | 2.3 | 99 | 12.94 - | B230GK | 4 | 0,8 | BPR6ES | 7822 | 2 | LPG 2 | 1497 |
| 940 GL, GLE TD | 2.4 | 85 | 09.90 - | D 24 TIC | 6 | █ | Y-918J | 6285 | | D-POWER 2 | 6285 |
| 940 TD | 2.4 | 80 | 09.90 - 08.93 | D 24 T | 6 | █ | Y-918J | 6285 | | D-POWER 2 | 6285 |
| 940 TD Interc., Kombi | 2.4 | 90 | 01.94 - | D 24 T | 6 | █ | Y-918J | 6285 | | D-POWER 2 | 6285 |
| 940i | 2.0 | 82 | 09.90 - 07.94 | B200E/B200F | 4 | 0,8 | BPR6ES | 7822 | 2 | LPG 2 | 1497 |
| 940i | 2.3 | 96 | 09.90 - 12.94 | B230F | 4 | 0,8 | BPR6ES | 7822 | 2 | LPG 2 | 1497 |
| 940i | 2.3 | 96 | 08.90 - 12.94 | B230FB | 4 | 0,8 | BPR6ES | 7822 | 2 | LPG 2 | 1497 |
| 940i | 2.3 | 126 | 08.94 - 10.98 | B230FT / FK | 4 | 0,8 | BPR6ES | 7822 | 2 | LPG 2 | 1497 |
| 940i 16V | 2.3 | 114 | 09.90 - 07.91 | B234F | 4 | 0,8 | BPR6ES | 7822 | 2 | LPG 2 | 1497 |
| 940i Turbo | 2.0 | 105 | 01.91 - 07.94 | B200FT | 4 | 0,8 | BPR6ES | 7822 | 2 | LPG 2 | 1497 |
| 940i Turbo Intercooler | 2.3 | 121 | 08.90 - 07.94 | B230FT | 4 | 0,8 | BPR6ES | 7822 | 2 | LPG 2 | 1497 |
| 960 | 2.5 | 125 | 09.94 - 12.96 | B6254F/G/S | 6 | 0,8 | BCPR6ES | 2330 | 12 | LPG 3 | 1498 |
| 960 | 3.0 | 135 | 09.94 - | B6304F | 6 | 0,8 | BCPR6ES | 2330 | 12 | LPG 3 | 1498 |
| 960 | 3.0 | 150 | 09.94 - | B6304F/G | 6 | 0,8 | BCPR6ES | 2330 | 12 | LPG 3 | 1498 |
| 960 TD Interc. | 2.4 | 85 | 09.91 - | D 24 TIC | 6 | █ | Y-918J | 6285 | | D-POWER 2 | 6285 |
| 960i | 2.8 | 110 | 09.90 - 08.91 | B280F | 6 | 1,0 | BPR6EFS | 3623 | 7 | LPG 5 | 1516 |
| 960i | 2.8 | 125 | 09.90 - | B280E | 6 | 0,6 | BP7EFS | 3526 | | | |
| 960i | 2.9 | 150 | 09.90 - 07.94 | B6304F | 6 | 0,8 | BCPR6ES | 2330 | 12 | LPG 3 | 1498 |
| 960i 16V Turbo Intercooler | 2.0 | 140 | 09.90 - | B204FT | 4 | 0,8 | BPR6ES | 7822 | 2 | LPG 2 | 1497 |
| 960i Turbo Intercooler | 2.3 | 121 | 09.90 - | B230FT / FK | 4 | 0,8 | BPR6ES | 7822 | 2 | LPG 2 | 1497 |
| C 30 1.6 | 1.6 | 74 | 11.06 - | B4164S3 | 4 | 1,3 | TR5B-13 | 4559 | | LPG 4 | 1511 |
| C 30 1.6D | 1.6 | 80 | 11.06 - | D4164T | 4 | █ | YE04 | 1684 | | D-POWER 40 | 1684 |
| C 30 1.8 | 1.8 | 92 | 11.06 - | B4184S8 / S11 | 4 | 1,3 | ITR6F13 | 4477 | | LPG 5 | 1516 |
| C 30 2.0 | 2.0 | 107 | 11.06 - | B4204S3 | 4 | 1,3 | ITR6F13 | 4477 | | LPG 5 | 1516 |
| C 30 2.4 | 2.4 | 125 | 11.06 - | B5244S4 | 5 | | LFR6D | 4704 | | LFR6D | 4704 |
| C 30 T 5 | 2.5 | 169 | 11.06 - | B5254T7 | 5 | 0,8 | ILFR6B | 6481 | | ILFR6B | 6481 |
| C 70 | 2.0 | 106 | 98 - | B5204S | 5 | 0,8 | BKR6ES | 3783 | 28 | LPG 1 | 1496 |
| C 70 | 2.0 | 132 | 03.97 - 10.05 | B5204T2 | 5 | 0,8 | BCPR7ES | 3330 | | BCPR7EIX | 5690 |
| C 70 | 2.0 | 166 | 01.97 - 10.05 | B5204T3 | 5 | 0,8 | BCPR7ES | 3330 | | BCPR7EIX | 5690 |
| C 70 | 2.3 | 180 | 07.02 - 10.05 | B5234T9 | 5 | 0,8 | BKR6EVX | 3539 | | LPG 1 | 1496 |
| C 70 | 2.4 | 103 | 03.06 - | B5244S5 | 5 | | LFR6D | 4704 | | LFR6D | 4704 |
| C 70 | 2.4 | 125 | 11.99 - 10.05 | B5244S | 5 | 0,8 | BKR6ES | 3783 | 28 | LPG 1 | 1496 |
| C 70 | 2.4 | 125 | 03.06 - | B5244S4 | 5 | | LFR6D | 4704 | | LFR6D | 4704 |
| C 70 | 2.4 | 147 | 07.02 - 10.05 | B5244T7 | 5 | 0,8 | BKR6EVX | 3539 | | LPG 1 | 1496 |
| C 70 | 2.4 | 176 | 00 - | B5224T | 5 | 0,8 | BKR6EVX | 3539 | | LPG 1 | 1496 |
| C 70 | 2.5 | 121 | 03.99 - 09.02 | B5254S | 5 | 0,8 | BKR6ES | 3783 | 28 | LPG 1 | 1496 |
| C 70 | 2.5 | 142 | 03.97 - 10.05 | B5254T | 5 | 0,8 | BKR6EVX | 3539 | | LPG 1 | 1496 |
| C 70 | 2.5 | 162 | 03.06 - | B5254T3 | 5 | 0,8 | ILFR6B | 6481 | | ILFR6B | 6481 |
| C 70 T5 | 2.3 | 176 | 97 - | B5234T | 5 | 0,8 | BKR7EVX | 3544 | | BKR8EIX | 2668 |



ℓ kW

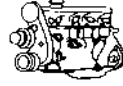

Cyl.

Order-
No. No.LPG/CNG
D-PowerOrder-
No.**VOLVO**

| | | | | | | | | | | | |
|-----------------------|-----|-----|---------------|---------------|---|-----|----------|------|----|------------|------|
| C 70 T5 | 2.3 | 176 | 03.97 - 10.05 | B5234T3 | 5 | 0,8 | BKR6EVX | 3539 | | LPG 1 | 1496 |
| C 70 T5 Turbo | 2.5 | 169 | 11.05 - | B5254T7 | 5 | 0,8 | ILFR6B | 6481 | | ILFR6B | 6481 |
| C 70 2.0 T | 2.0 | 120 | 03.00 - 10.05 | B5204T4 | 5 | 0,8 | BKR6EVX | 3539 | | LPG 1 | 1496 |
| C 70 2.4 T | 2.4 | 142 | 08.99 - 10.05 | B5244T | 5 | 0,8 | BKR6EVX | 3539 | | LPG 1 | 1496 |
| S 40 | 1.6 | | 04.97 - | B4164S | 4 | | BKR6EKUB | 3584 | | LPG 1 | 1496 |
| S 40 | 1.8 | | 04.98 - 12.03 | B4184SM / SJ | 4 | 0,8 | IZFR6B | 3116 | | | |
| S 40 1.6 | 1.6 | 74 | 01.05 - | B4164S3 | 4 | 1,3 | TR5B-13 | 4559 | | LPG 4 | 1511 |
| S 40 1.6 | 1.6 | 80 | 03.99 - 12.03 | B4164S2 | 4 | | BCPR6ET | 2197 | | LPG 3 | 1498 |
| S 40 1.8 | 1.8 | 90 | 03.99 - 12.03 | B4184S2 | 4 | | BCPR6ET | 2197 | | LPG 3 | 1498 |
| S 40 1.8 | 1.8 | 92 | 04.04 - | B4184S8 / S11 | 4 | 1,3 | ITR6F13 | 4477 | | LPG 5 | 1516 |
| S 40 1.8 GDI | 1.8 | 92 | 06.01 - 12.03 | B4184SJ | 4 | 0,6 | IZFR6B | 3116 | | IZFR6B | 3116 |
| S 40 1.9D | 1.6 | 81 | 01.05 - | D4164T | 4 | █ | YE04 | 1684 | | D-POWER 40 | 1684 |
| S 40 1.9D | 1.9 | 66 | 07.95 - 08.99 | D4192T | 4 | █ | Y-933J | 7947 | | D-POWER 25 | 7947 |
| S 40 1.9D | 1.9 | 75 | 07.00 - 12.03 | D4192T4 / Di | 4 | █ | Y-732J | 5605 | | D-POWER 4 | 5605 |
| S 40 1.9D | 1.9 | 85 | 07.00 - 12.03 | D4192T3 / DI | 4 | █ | Y-732J | 5605 | | D-POWER 4 | 5605 |
| S 40 2.0 | 2.0 | 100 | 07.95 - 12.03 | B4204S2 | 4 | | BCPR6ET | 2197 | | LPG 3 | 1498 |
| S 40 2.0 | 2.0 | 107 | 10.06 - | B4204S3 | 4 | 1,3 | ITR6F13 | 4477 | | LPG 5 | 1516 |
| S 40 2.0 T | 2.0 | 120 | 10.97 - 12.03 | B4204T3 | 4 | 0,8 | BKR6EVX | 3539 | | LPG 1 | 1496 |
| S 40 2.4 | 2.4 | 103 | 01.04 - | B5244S5 | 5 | | LFR6D | 4704 | | LFR6D | 4704 |
| S 40 2.4i | 2.4 | 125 | 01.04 - | B5244S4 | 5 | | LFR6D | 4704 | | LFR6D | 4704 |
| S 40 Bi-Fuel Holland | 1.8 | 88 | 03.99 - 12.03 | B4184S9 | 4 | | BCPR6ET | 2197 | | LPG 3 | 1498 |
| S 40 T4 | 1.9 | 147 | 05.97 - 07.00 | B4194T / T2 | 4 | 0,8 | PFR6G | 4793 | | PFR7G | 4364 |
| S 40 T4 | 2.0 | 147 | 07.00 - 12.03 | B4204T5 | 4 | 0,8 | BKR6EVX | 3539 | | LPG 1 | 1496 |
| S 40 T5 | 2.5 | 162 | 01.04 - | B5254T3 | 5 | 0,8 | ILFR6B | 6481 | | ILFR6B | 6481 |
| S 40 T5 | 2.5 | 169 | 03.07 - | B5254T7 | 5 | 0,8 | ILFR6B | 6481 | | ILFR6B | 6481 |
| S 60 | 2.4 | | 10.00 - | B5244T | 5 | 0,8 | PFR6B | 3500 | | | |
| S 60 2.0 T | 2.0 | 132 | 09.01 - | B5204T5 | 5 | 0,8 | BKR6EVX | 3539 | | LPG 1 | 1496 |
| S 60 2.3 T | 2.3 | 147 | 00 - | B5234T7 | 5 | 0,8 | BKR6EVX | 3539 | | LPG 1 | 1496 |
| S 60 2.4 | 2.4 | 103 | 11.00 - | B5244S2 | 5 | 0,8 | BKR6ES | 3783 | 28 | LPG 1 | 1496 |
| S 60 2.4 | 2.4 | 125 | 11.00 - | B5244S | 5 | 0,8 | BKR6ES | 3783 | 28 | LPG 1 | 1496 |
| S 60 2.4 T | 2.4 | 147 | 11.00 - | B5244T3 | 5 | 0,8 | BKR6EVX | 3539 | | LPG 1 | 1496 |
| S 60 2.4D | 2.4 | 120 | 07.01 - | D5244T | 5 | █ | YE12 | 7794 | | | |
| S 60 2.5T | 2.5 | 154 | 02.04 - | B5254T2 | 5 | 0,8 | BKR6EVX | 3539 | | LPG 1 | 1496 |
| S 60 Bi-Fuel CNG (DK) | 2.4 | 103 | 06.00 - | B5244SG | 5 | | LPG 1 | 1496 | | LPG 1 | 1496 |
| S 60 Bi-Fuel LPG | 2.4 | 103 | 06.02 - | B5244SG2 | 5 | | LPG 1 | 1496 | | LPG 1 | 1496 |
| S 60 R 2.5T | 2.5 | 220 | 03.03 - | B5254T4 | 5 | 0,8 | ILFR6B | 6481 | | ILFR6B | 6481 |
| S 60 T5 | 2.3 | 184 | 11.00 - | B5234T3 | 5 | 0,8 | BKR6EVX | 3539 | | LPG 1 | 1496 |
| S 60 T5 | 2.4 | 191 | 04.04 - | B5244T5 | 5 | 0,8 | ILFR6B | 6481 | | ILFR6B | 6481 |
| S 70 | 2.0 | 93 | 01.97 - 11.00 | B5202S | 5 | 0,8 | BKR6ES | 3783 | 28 | LPG 1 | 1496 |
| S 70 | 2.0 | 105 | 01.97 - 11.00 | B5204S | 5 | 0,8 | BKR6ES | 3783 | 28 | LPG 1 | 1496 |
| S 70 | 2.0 | 120 | 01.97 - 11.00 | B5204T4 | 5 | 0,8 | BKR6EVX | 3539 | | LPG 1 | 1496 |
| S 70 | 2.0 | 132 | 01.97 - 11.00 | B5204T2 | 5 | 0,8 | BCPR7ES | 3330 | | BCPR7EIX | 5690 |
| S 70 | 2.0 | 154 | 01.97 - 11.00 | B5204T | 5 | 0,8 | BCPR7ES | 3330 | | BCPR7EIX | 5690 |
| S 70 | 2.0 | 166 | 01.97 - 11.00 | B5204T3 | 5 | 0,8 | BCPR7ES | 3330 | | BCPR7EIX | 5690 |
| S 70 | 2.3 | 120 | 99 - | B5234S | 5 | 0,8 | BKR6ES | 3783 | 28 | LPG 1 | 1496 |
| S 70 | 2.3 | 166 | 09.97 - | B5234T | 5 | 0,8 | BCPR7ES | 3330 | | BCPR7EIX | 5690 |
| S 70 | 2.3 | 177 | 99 - | B5234T5 | 5 | 0,8 | BCPR7ES | 3330 | | BCPR7EIX | 5690 |
| S 70 | 2.3 | 177 | 99 - | B5234T6 | 5 | 0,8 | BCPR7ES | 3330 | | BCPR7EIX | 5690 |
| S 70 | 2.3 | 184 | 01.97 - 11.00 | B5234T3 | 5 | 0,8 | BKR7EVX | 3544 | | BKR8EIX | 2668 |
| S 70 | 2.3 | 184 | 01.97 - 11.00 | B5234T4 | 5 | 0,9 | BKR7E | 6097 | | BKR8EIX | 2668 |
| S 70 | 2.3 | 184 | 01.97 - 11.00 | B5234T8 | 5 | 0,9 | BKR7E | 6097 | | BKR8EIX | 2668 |
| S 70 | 2.4 | 103 | 08.99 - 11.00 | B5244S2 | 5 | 0,8 | BKR6ES | 3783 | 28 | LPG 1 | 1496 |



ℓ kW

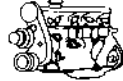

Cyl.

Order-
No.VLINE
No.LPG/CNG
D-PowerOrder-
No.**VOLVO**

| | | | | | | | | | | | |
|----------------------|-----|-----|--------------|--------------|---|-----|----------|-------|----|------------|-------|
| S 70 | 2.4 | 125 | 99 - | B5244S | 5 | 0,8 | BKR6ES | 3783 | 28 | LPG 1 | 1496 |
| S 70 | 2.4 | 195 | 99 - | B5244T2 | 5 | 0,8 | BCPR7ES | 3330 | | BCPR7EIX | 5690 |
| S 70 | 2.5 | 103 | 01.97 - | D5252T | 5 | █ | Y-732J | 5605 | | D-POWER 4 | 5605 |
| S 70 2.4 T | 2.4 | 142 | 01.97 -07.99 | B5244T | 5 | 0,8 | BKR6EVX | 3539 | | LPG 1 | 1496 |
| S 70 2.5 10V | 2.5 | 106 | 01.97 -11.00 | B5252S | 5 | 0,8 | BKR6ES | 3783 | 28 | LPG 1 | 1496 |
| S 70 2.5 20V | 2.5 | 125 | 01.97 -11.00 | B5254S | 5 | 0,8 | BKR6ES | 3783 | 28 | LPG 1 | 1496 |
| S 70 2.5 T | 2.5 | 142 | 01.97 -11.00 | B5254T | 5 | 0,8 | BKR6EVX | 3539 | | LPG 1 | 1496 |
| S 70 TDi | 2.5 | 103 | 01.97 - | D5252 (Audi) | 5 | █ | Y-732J | 5605 | | D-POWER 4 | 5605 |
| S 80 | 2.0 | 166 | 06.98 - | B5204T3 | 5 | 0,8 | BCPR7ES | 3330 | | BCPR7EIX | 5690 |
| S 80 | 3.0 | 150 | 06.99 - | B6304S | 6 | 0,8 | BKR6ES | 3783 | 28 | LPG 1 | 1496 |
| S 80 2.0 | 2.0 | 107 | 11.07 - | B4204S3 / S4 | 4 | 1,3 | ITR6F13 | 4477 | | LPG 5 | 1516 |
| S 80 2.0 T | 2.0 | 132 | 12.99 - | B5204T5 | 5 | 0,8 | BKR6EVX | 3539 | | LPG 1 | 1496 |
| S 80 2.3 T | 2.3 | 147 | 99 - | B5234T7 | 5 | 0,8 | BKR6EVX | 3539 | | LPG 1 | 1496 |
| S 80 2.4 | 2.4 | 103 | 01.99 - | B5244S2 | 5 | 0,8 | BKR6ES | 3783 | 28 | LPG 1 | 1496 |
| S 80 2.4 | 2.4 | 125 | 05.98 - | B5244S | 5 | 0,8 | BKR6ES | 3783 | 28 | LPG 1 | 1496 |
| S 80 2.4 | 2.4 | 147 | 08.00 -07.03 | B5244T3 | 5 | 0,8 | BKR6EVX | 3539 | | LPG 1 | 1496 |
| S 80 2.4 T | 2.4 | 147 | 06.00 - | B5244T3 | 5 | 0,8 | BKR6EVX | 3539 | | LPG 1 | 1496 |
| S 80 2.4D | 2.4 | 120 | 08.01 - | D5244T | 5 | █ | YE12 | 7794 | | | |
| S 80 2.5 T | 2.5 | 147 | 11.07 - | B5254T6 / T8 | 5 | 0,8 | ILFR6K8 | 94040 | | ILFR6K8 | 94040 |
| S 80 2.5 T AWD | 2.5 | 154 | 07.03 - | B5254T2 | 5 | 0,8 | BKR6EVX | 3539 | | LPG 1 | 1496 |
| S 80 2.5D | 2.5 | 103 | 01.99 - | D5252T | 5 | █ | Y-732J | 5605 | | D-POWER 4 | 5605 |
| S 80 2.8 T | 2.8 | 200 | 05.98 - | B6284T | 6 | 0,8 | BKR6EVX | 3539 | | LPG 1 | 1496 |
| S 80 2.9 | 2.9 | 144 | 06.01 - | B6294S / S2 | 6 | █ | BKR6EKUB | 3584 | | LPG 1 | 1496 |
| S 80 3.0 | 3.0 | 147 | 05.98 - | B6304S3 | 6 | 0,8 | BKR6ES | 3783 | 28 | LPG 1 | 1496 |
| S 80 3.0 T | 3.0 | 210 | 11.07 - | B6304T2 | 6 | 0,8 | ILFR6B | 6481 | | ILFR6B | 6481 |
| S 80 3.2 S | 3.2 | 175 | 11.07 - | B6324S | 6 | 0,8 | ILFR6B | 6481 | | ILFR6B | 6481 |
| S 80 Bi-Fuel CNG | 2.4 | 103 | 09.01 - | B5244SG | 5 | | LPG 1 | 1496 | | LPG 1 | 1496 |
| S 80 Bi-Fuel LPG | 2.4 | 103 | 09.01 - | B5244SG2 | 5 | | LPG 1 | 1496 | | LPG 1 | 1496 |
| S 80 T6 | 2.8 | 200 | 06.98 - | B6284T2 | 6 | 0,8 | BKR6EVX | 3539 | | LPG 1 | 1496 |
| S 80 T6 | 2.9 | 200 | 06.01 - | B6294T | 6 | 0,8 | BKR6EVX | 3539 | | LPG 1 | 1496 |
| S 90 | 2.4 | 120 | 97 - | B6244F | 6 | 0,8 | BCPR6ES | 2330 | 12 | LPG 3 | 1498 |
| S 90 | 2.5 | 125 | 97 - | B6254F | 6 | 0,8 | BCPR6ES | 2330 | 12 | LPG 3 | 1498 |
| S 90 | 2.5 | 125 | 97 - | B6254G | 6 | 0,8 | BCPR6ES | 2330 | 12 | LPG 3 | 1498 |
| S 90 | 3.0 | 150 | 97 - | B6304F | 6 | 0,8 | BCPR6ES | 2330 | 12 | LPG 3 | 1498 |
| S 90 | 3.0 | 150 | 01.97 -05.98 | B6304G | 6 | 0,8 | BCPR6ES | 2330 | 12 | LPG 3 | 1498 |
| S 90 3.0 | 3.0 | 132 | 01.97 -05.98 | B6304S | 6 | 0,8 | BKR6ES | 3783 | 28 | LPG 1 | 1496 |
| S 90 3.0 | 3.0 | 150 | 01.97 - | B6304S | 6 | 0,8 | BKR6ES | 3783 | 28 | LPG 1 | 1496 |
| V 40 | 1.8 | | 96 - | B4184 S | 4 | | BKR6EKUB | 3584 | | LPG 1 | 1496 |
| V 40 | 1.8 | | 04.98 -09.00 | B4184SM/SJ | 4 | 0,8 | IZFR6B | 3116 | | | |
| V 40 1.6 | 1.6 | 80 | 03.99 - | B4164S2 | 4 | | BCPR6ET | 2197 | | LPG 3 | 1498 |
| V 40 1.8 | 1.8 | 90 | 03.99 - | B4184S2 | 4 | | BCPR6ET | 2197 | | LPG 3 | 1498 |
| V 40 1.8 GDI | 1.8 | 92 | 08.97 -04.04 | B4184SJ | 4 | 0,6 | IZFR6B | 3116 | | IZFR6B | 3116 |
| V 40 1.9 D | 1.9 | 66 | 02.96 - | D4192T | 4 | █ | Y-933J | 7947 | | D-POWER 25 | 7947 |
| V 40 1.9 D | 1.9 | 75 | 07.00 -06.04 | D4192T4 / DI | 4 | █ | Y-732J | 5605 | | D-POWER 4 | 5605 |
| V 40 1.9 D | 1.9 | 85 | 07.00 -06.04 | D4192T3 / DI | 4 | █ | Y-732J | 5605 | | D-POWER 4 | 5605 |
| V 40 1.9 DCI | 1.9 | | 07.00 - | dCi Renault | 4 | █ | Y-732J | 5605 | | D-POWER 4 | 5605 |
| V 40 1.9 DI | 1.9 | 70 | 03.99 -07.00 | D4192T2 | 4 | █ | Y-740U | 4818 | | D-POWER 22 | 4818 |
| V 40 2.0 | 2.0 | 100 | 96 - | B4204S2 | 4 | | BCPR6ET | 2197 | | LPG 3 | 1498 |
| V 40 2.0 T | 2.0 | 120 | 06.00 -04.04 | B4204T3 | 4 | 0,8 | PFR6G | 4793 | | PFR7G | 4364 |
| V 40 2.0 T | 2.0 | 147 | 07.00 -04.04 | B4204T5 | 4 | 0,8 | BKR6EVX | 3539 | | LPG 1 | 1496 |
| V 40 Bi-Fuel Holland | 1.8 | 88 | | B4184S9 | 4 | | BCPR6ET | 2197 | | LPG 3 | 1498 |
| V 40 T4 | 1.9 | 147 | 05.97 -07.00 | B4194T / T2 | 4 | 0,8 | PFR6G | 4793 | | PFR7G | 4364 |



ℓ kW



Cyl.

Order-
No. No.LPG/CNG
D-PowerOrder-
No.**VOLVO**

| | | | | | | | | | | | |
|------------------|-----|-----|---------------|---------------|---|-----|---------|-------|----|------------|-------|
| V 50 1.6 | 1.6 | 74 | 01.05 - | B4164S3 | 4 | 1,3 | TR5B-13 | 4559 | | LPG 4 | 1511 |
| V 50 1.6D | 1.6 | 80 | 01.05 - | D4164T | 4 | ▣ | YE04 | 1684 | | D-POWER 40 | 1684 |
| V 50 1.8 | 1.8 | 92 | 04.04 - | B4184S8 / S11 | 4 | 1,3 | ITR6F13 | 4477 | | LPG 5 | 1516 |
| V 50 2.0 | 2.0 | 107 | 08.07 - | B4204S3 | 4 | 1,3 | ITR6F13 | 4477 | | LPG 5 | 1516 |
| V 50 2.4 | 2.4 | 103 | 04.04 - | B5244S5 | 5 | | LFR6D | 4704 | | LFR6D | 4704 |
| V 50 2.4i | 2.4 | 125 | 04.04 - | B5244S4 | 5 | | LFR6D | 4704 | | LFR6D | 4704 |
| V 50 2.5 | 2.5 | 169 | 07 - | B5254T7 | 5 | 0,8 | ILFR6B | 6481 | | ILFR6B | 6481 |
| V 50 T5 | 2.5 | 162 | 04.04 - | B5254T3 | 5 | 0,8 | ILFR6B | 6481 | | ILFR6B | 6481 |
| V 70 | 2.0 | 105 | 01.97 - 03.00 | B5204S | 5 | 0,8 | BKR6ES | 3783 | 28 | LPG 1 | 1496 |
| V 70 | 2.0 | 154 | 01.97 - 03.00 | B5204T | 5 | 0,8 | BCPR7ES | 3330 | | BCPR7EIX | 5690 |
| V 70 | 2.0 | 166 | 01.97 - 03.00 | B5204T3 | 5 | 0,8 | BCPR7ES | 3330 | | BCPR7EIX | 5690 |
| V 70 | 2.3 | 120 | 01.99 - | B5234S | 5 | 0,8 | BKR6ES | 3783 | 28 | LPG 1 | 1496 |
| V 70 | 2.3 | 166 | 09.97 - 03.00 | B5234T | 5 | 0,8 | BCPR7ES | 3330 | | BCPR7EIX | 5690 |
| V 70 | 2.3 | 177 | 99 - | B5234T5 | 5 | 0,8 | BCPR7ES | 3330 | | BCPR7EIX | 5690 |
| V 70 | 2.3 | 177 | 99 - | B5234T6 | 5 | 0,8 | BCPR7ES | 3330 | | BCPR7EIX | 5690 |
| V 70 | 2.3 | 184 | 04.97 - 03.00 | B5234T4 | 5 | 0,8 | BKR6EVX | 3539 | | LPG 1 | 1496 |
| V 70 | 2.3 | 184 | 01.97 - 03.00 | B5234T8 | 5 | 0,8 | BKR6EVX | 3539 | | LPG 1 | 1496 |
| V 70 | 2.3 | 184 | 03.00 - | B5234T3 | 5 | 0,8 | BKR6EVX | 3539 | | LPG 1 | 1496 |
| V 70 | 2.4 | 142 | 01.97 - 03.00 | B5244T | 5 | 0,8 | BKR6EVX | 3539 | | LPG 1 | 1496 |
| V 70 | 2.4 | 195 | 03.99 - 03.00 | B5244T2 | 5 | 0,8 | BCPR7ES | 3330 | | BCPR7EIX | 5690 |
| V 70 | 2.5 | 142 | 01.97 - 03.00 | B5254T | 5 | 0,8 | BKR6EVX | 3539 | | LPG 1 | 1496 |
| V 70 | 2.5 | 154 | 04.04 - | B5254T2 | 5 | 0,8 | BKR6EVX | 3539 | | LPG 1 | 1496 |
| V 70 | 3.2 | 175 | 08.07 - | B6324S | 6 | 0,8 | ILFR6B | 6481 | | ILFR6B | 6481 |
| V 70 T5 | 2.4 | 191 | 04.04 - 07.07 | B5244T5 | 5 | 0,8 | ILFR6B | 6481 | | ILFR6B | 6481 |
| V 70 Turbo | 3.0 | 210 | 08.07 - | B6304T2 | 6 | 0,8 | ILFR6B | 6481 | | ILFR6B | 6481 |
| V 70 2.0 | 2.0 | 93 | 01.97 - 03.00 | B5202S | 5 | 0,8 | BKR6ES | 3783 | 28 | LPG 1 | 1496 |
| V 70 2.0 | 2.0 | 107 | 10.07 - | B4204S3 / S4 | 4 | 1,3 | ITR6F13 | 4477 | | LPG 5 | 1516 |
| V 70 2.0 T | 2.0 | 120 | 01.97 - 03.00 | B5204T4 | 5 | 0,8 | BKR6EVX | 3539 | | LPG 1 | 1496 |
| V 70 2.0 T | 2.0 | 132 | 01.97 - 03.00 | B5204T2 | 5 | 0,8 | BKR6EVX | 3539 | | LPG 1 | 1496 |
| V 70 2.0 T | 2.0 | 132 | 07.01 - | B5204T5 | 5 | 0,8 | BKR6EVX | 3539 | | LPG 1 | 1496 |
| V 70 2.3 T | 2.3 | 147 | 00 - | B5234T7 | 5 | 0,8 | BKR6EVX | 3539 | | LPG 1 | 1496 |
| V 70 2.4 | 2.4 | 103 | 08.99 - 03.00 | B5244S2 | 5 | 0,8 | BKR6ES | 3783 | 28 | LPG 1 | 1496 |
| V 70 2.4 | 2.4 | 125 | 03.00 - | B5244S | 5 | 0,8 | BKR6ES | 3783 | 28 | LPG 1 | 1496 |
| V 70 2.4 T | 2.4 | 147 | 03.00 - | B5244T3 | 5 | 0,8 | BKR6EVX | 3539 | | LPG 1 | 1496 |
| V 70 2.4D | 2.4 | 120 | 08.01 - | D5244T | 5 | ▣ | YE12 | 7794 | | | |
| V 70 2.5 | 2.5 | 147 | 08.07 - | B5254T6 / T8 | 5 | 0,8 | ILFR6K8 | 94040 | | ILFR6K8 | 94040 |
| V 70 2.5 10V | 2.5 | 106 | 01.97 - 03.00 | B5252S | 5 | 0,8 | BKR6ES | 3783 | 28 | LPG 1 | 1496 |
| V 70 2.5 20V | 2.5 | 125 | 01.97 - 03.00 | B5254S | 5 | 0,8 | BKR6ES | 3783 | 28 | LPG 1 | 1496 |
| V 70 2.5D | 2.5 | 103 | 01.97 - 03.00 | D5252T | 5 | ▣ | Y-732J | 5605 | | D-POWER 4 | 5605 |
| V 70 Bi-Fuel CNG | 2.4 | 103 | 08.99 - 03.00 | B5244SG | 5 | | LPG 1 | 1496 | | LPG 1 | 1496 |
| V 70 Bi-Fuel LPG | 2.4 | 103 | 08.99 - 03.00 | B5244SG2 | 5 | | LPG 1 | 1496 | | LPG 1 | 1496 |
| V 70 R | 2.5 | 220 | 03.03 - | B5254T4 | 5 | 0,8 | ILFR6B | 6481 | | ILFR6B | 6481 |
| V 70 T-5 | 2.3 | 184 | 01.97 - 03.00 | B5234T3 | 5 | 0,8 | BKR7EVX | 3544 | | BKR8EIX | 2668 |
| V 90 | 2.4 | 120 | 97 - | B6244F | 6 | 0,8 | BCPR6ES | 2330 | 12 | LPG 3 | 1498 |
| V 90 | 2.5 | 125 | 97 - | B6254F | 6 | 0,8 | BCPR6ES | 2330 | 12 | LPG 3 | 1498 |
| V 90 | 2.5 | 125 | 97 - | B6254G | 6 | 0,8 | BCPR6ES | 2330 | 12 | LPG 3 | 1498 |
| V 90 | 2.9 | 150 | 97 - | B6304F | 6 | 0,8 | BCPR6ES | 2330 | 12 | LPG 3 | 1498 |
| V 90 | 2.9 | 150 | 97 - | B6304G | 6 | 0,8 | BCPR6ES | 2330 | 12 | LPG 3 | 1498 |
| V 90 3.0 | 3.0 | 132 | 01.97 - | B6304S2 | 6 | 0,8 | BKR6ES | 3783 | 28 | LPG 1 | 1496 |
| V 90 3.0 | 3.0 | 150 | 01.97 - | B6304S | 6 | 0,8 | BKR6ES | 3783 | 28 | LPG 1 | 1496 |
| XC60 3.0 | 3.0 | 210 | 10.08 - | B6304T2 | 6 | 0,8 | ILFR6B | 6481 | | ILFR6B | 6481 |
| XC70 2.4D5 | 2.4 | 120 | 09.02 - | D5244T5 | 5 | ▣ | YE12 | 7794 | | | |



ℓ kW

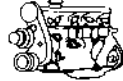

Cyl.

Order-
No.VLINE
No.LPG/CNG
D-PowerOrder-
No.**VOLVO**

| | | | | | | | | | | | |
|-----------------|-----|-----|-------------|---------|---|-----|----------|------|--|--------|------|
| XC70 2.4T | 2.4 | 147 | 09.00-09.02 | B5244T3 | 5 | 0,8 | BKR6EVX | 3539 | | LPG 1 | 1496 |
| XC70 2.5T | 2.5 | 154 | 09.02- | B5254T2 | 5 | 0,8 | BKR6EVX | 3539 | | LPG 1 | 1496 |
| XC70 3.2 | 3.2 | 175 | 02.07- | B6324S | 6 | 0,8 | ILFR6B | 6481 | | ILFR6B | 6481 |
| XC90 2.5T | 2.5 | 154 | 10.02- | B5254T2 | 5 | 0,8 | BKR6EVX | 3539 | | LPG 1 | 1496 |
| XC90 3.2 | 3.2 | 175 | 05.06- | B6324S | 6 | 0,8 | ILFR6B | 6481 | | ILFR6B | 6481 |
| XC90 4.4 | 4.4 | 232 | 11.04- | B8444S | 8 | 1,1 | IFR6B-11 | 5368 | | | |
| XC90 D5 | 2.4 | 120 | 02.03- | D5244T | 5 | █ | YE12 | 7794 | | | |
| XC90 T6 Biturbo | 2.9 | 200 | 10.02- | B6294T | 6 | 0,8 | BKR6EVX | 3539 | | LPG 1 | 1496 |

VW

| | | | | | | | | | | | |
|----------------------------|-----|-----|-------------|------|---|-----|------------|------|----|------------|------|
| Beetle | 1.4 | 55 | 08.01- | BCA | 4 | 1,1 | PZFR5D-11 | 7968 | 34 | LPG 6 | 1565 |
| Beetle | 1.6 | 74 | 11.99-10.00 | AWH | 4 | | BKUR6ET-10 | 2397 | 24 | LPG 1 | 1496 |
| Beetle | 1.6 | 74 | 06.00- | AYD | 4 | | BKUR6ET-10 | 2397 | 24 | LPG 1 | 1496 |
| Beetle | 1.6 | 75 | 06.02- | BFS | 4 | | BKUR6ET-10 | 2397 | 24 | LPG 1 | 1496 |
| Beetle | 1.8 | 110 | 01.98-06.00 | AGU | 4 | 0,8 | PFR6Q | 6458 | 37 | LPG 1 | 1496 |
| Beetle | 1.8 | 110 | 01.99-06.00 | APH | 4 | 0,8 | PFR6Q | 6458 | 37 | LPG 1 | 1496 |
| Beetle | 1.8 | 110 | 07.99-10.00 | AVC | 4 | 0,8 | PFR6Q | 6458 | 37 | LPG 1 | 1496 |
| Beetle | 1.8 | 110 | 10.00- | AWU | 4 | 0,8 | PFR6Q | 6458 | 37 | LPG 1 | 1496 |
| Beetle | 1.8 | 110 | 06.00-06.04 | AWV | 4 | 0,8 | PFR6Q | 6458 | 37 | LPG 1 | 1496 |
| Beetle | 1.8 | 110 | 07.04- | BKF | 4 | 0,8 | PFR6Q | 6458 | 37 | LPG 1 | 1496 |
| Beetle | 1.8 | 132 | 06.02-06.04 | AWP | 4 | 0,8 | PFR6Q | 6458 | 37 | LPG 1 | 1496 |
| Beetle | 2.0 | 85 | 01.98-05.01 | AEG | 4 | | BKUR6ET-10 | 2397 | 24 | LPG 1 | 1496 |
| Beetle | 2.0 | 85 | 03.00- | APK | 4 | | BKUR6ET-10 | 2397 | 24 | LPG 1 | 1496 |
| Beetle | 2.0 | 85 | 08.98- | AQY | 4 | | BKUR6ET-10 | 2397 | 24 | LPG 1 | 1496 |
| Beetle | 2.0 | 85 | 06.02-07.03 | AZG | 4 | 1,1 | PZFR5D-11 | 7968 | 34 | LPG 6 | 1565 |
| Beetle | 2.0 | 85 | 06.01- | AZJ | 4 | 1,1 | PZFR5D-11 | 7968 | 34 | LPG 6 | 1565 |
| Beetle | 2.0 | 85 | 01.03- | BER | 4 | 1,1 | PZFR5D-11 | 7968 | 34 | LPG 6 | 1565 |
| Beetle | 2.0 | 85 | 07.04- | BEV | 4 | 1,1 | PZFR5D-11 | 7968 | 34 | LPG 6 | 1565 |
| Beetle | 2.0 | 85 | 07.05- | BHP | 4 | | BKUR6ET-10 | 2397 | 24 | LPG 1 | 1496 |
| Beetle | 2.0 | 85 | 03.07- | CBPA | 4 | | BKUR6ET-10 | 2397 | 24 | LPG 1 | 1496 |
| Beetle | 2.3 | 125 | 10.00- | AQN | 5 | 1,1 | PZFR5D-11 | 7968 | 34 | LPG 6 | 1565 |
| Beetle Fgst → 1C-6-413 286 | 2.5 | 110 | 07.05- | BPR | 5 | 1,1 | PZFR5J-11 | 7743 | | LPG 6 | 1565 |
| Beetle Fgst → 1C-6-413 286 | 2.5 | 110 | 07.05- | BPS | 5 | 1,1 | PZFR5J-11 | 7743 | | LPG 6 | 1565 |
| Beetle RSI | 3.2 | 165 | 10.00-05.01 | AXJ | 6 | 1,1 | PZFR5D-11 | 7968 | 34 | LPG 6 | 1565 |
| Beetle TDI | 1.9 | 66 | 01.98-06.04 | ALH | 4 | █ | Y-732J | 5605 | | D-POWER 4 | 5605 |
| Beetle TDI | 1.9 | 74 | 10.00- | ATD | 4 | █ | Y-741U | 6943 | | D-POWER 20 | 6943 |
| Beetle TDI | 1.9 | 74 | 10.00-10.01 | ATD | 4 | █ | Y-732J | 5605 | | D-POWER 4 | 5605 |
| Beetle TDI | 1.9 | 74 | 06.03- | AXR | 4 | █ | Y-741U | 6943 | | D-POWER 20 | 6943 |
| Beetle TDI | 1.9 | 74 | 07.05-12.06 | BEW | 4 | █ | CZ104 | 9826 | | D-POWER 52 | 9826 |
| Beetle TDI | 1.9 | 77 | 07.05- | BSW | 4 | █ | Y-741U | 6943 | | D-POWER 20 | 6943 |
| Bora | 1.4 | 55 | 10.98-05.05 | AHW | 4 | | BKUR6ET-10 | 2397 | 24 | LPG 1 | 1496 |
| Bora | 1.4 | 55 | 05.00-10.01 | AXP | 4 | | BKUR6ET-10 | 2397 | 24 | LPG 1 | 1496 |
| Bora | 1.4 | 55 | 10.01-05.05 | BCA | 4 | | BKUR6ET-10 | 2397 | 24 | LPG 1 | 1496 |
| Bora | 1.6 | 74 | 09.98-06.02 | AEH | 4 | | BKUR6ET-10 | 2397 | 24 | LPG 1 | 1496 |
| Bora | 1.6 | 74 | 09.98-05.03 | AKL | 4 | | BKUR6ET-10 | 2397 | 24 | LPG 1 | 1496 |
| Bora | 1.6 | 74 | 05.99-09.00 | APF | 4 | | BKUR6ET-10 | 2397 | 24 | LPG 1 | 1496 |
| Bora | 1.6 | 74 | 09.00-04.02 | AVU | 4 | | BKUR6ET-10 | 2397 | 24 | LPG 1 | 1496 |
| Bora | 1.6 | 75 | 05.02-05.05 | BFQ | 4 | | BKUR6ET-10 | 2397 | 24 | LPG 1 | 1496 |
| Bora | 1.6 | 77 | 11.99-05.00 | ATN | 4 | | BKUR6ET-10 | 2397 | 24 | LPG 1 | 1496 |
| Bora | 1.6 | 77 | 05.00-10.00 | AUS | 4 | | BKUR6ET-10 | 2397 | 24 | LPG 1 | 1496 |
| Bora | 1.6 | 77 | 11.01-05.05 | BCB | 4 | 1,1 | PZFR6J-11 | 3586 | | LPG 6 | 1565 |
| Bora | 1.8 | 92 | 09.98-10.00 | AGN | 4 | | BKUR6ET-10 | 2397 | 24 | LPG 1 | 1496 |

Fgst = Chassis No.



ℓ kW



Cyl.

Order-
No. No.LPG/CNG
D-PowerOrder-
No.**VW**

| | | | | | | | | | | | |
|-----------------------------|-----|-----|---------------|-----|---|-----|------------|------|----|------------|------|
| Bora | 1.8 | 110 | 09.00 - 05.03 | AGU | 4 | 0,8 | PFR6Q | 6458 | 37 | LPG 1 | 1496 |
| Bora | 1.8 | 110 | 09.00 - 04.01 | ARX | 4 | 0,8 | PFR6Q | 6458 | 37 | LPG 1 | 1496 |
| Bora | 1.8 | 110 | 09.00 - 05.05 | AUM | 4 | 0,8 | PFR6Q | 6458 | 37 | LPG 1 | 1496 |
| Bora | 1.8 | 132 | 05.02 - 05.05 | AUQ | 4 | 0,8 | PFR6Q | 6458 | 37 | LPG 1 | 1496 |
| Bora | 2.0 | 85 | 11.98 - 05.05 | APK | 4 | | BKUR6ET-10 | 2397 | 24 | LPG 1 | 1496 |
| Bora | 2.0 | 85 | 09.98 - 05.05 | AQY | 4 | | BKUR6ET-10 | 2397 | 24 | LPG 1 | 1496 |
| Bora | 2.0 | 85 | 04.00 - 06.01 | AZH | 4 | | BKUR6ET-10 | 2397 | 24 | LPG 1 | 1496 |
| Bora | 2.0 | 85 | 05.01 - 05.05 | AZJ | 4 | 1,1 | PZFR5D-11 | 7968 | 34 | LPG 6 | 1565 |
| Bora | 2.3 | 110 | 09.98 - 02.01 | AGZ | 5 | | BKR5EKUP | 2890 | | | |
| Bora | 2.3 | 125 | 09.00 - 05.05 | AQN | 5 | 1,1 | PZFR5D-11 | 7968 | 34 | LPG 6 | 1565 |
| Bora | 2.8 | 150 | 05.01 - 05.03 | BDE | 6 | 1,1 | PZFR5D-11 | 7968 | 34 | LPG 6 | 1565 |
| Bora China | 1.6 | 74 | 10.04 - | BJH | 4 | | BKR6E | 6962 | 28 | LPG 1 | 1496 |
| Bora China | 1.6 | 78 | | AWB | 4 | 0,8 | BKR5E | 7938 | 35 | LPG 1 | 1496 |
| Bora China | 1.8 | 92 | | BAF | 4 | | BKUR6ET-10 | 2397 | 24 | LPG 1 | 1496 |
| Bora 16V | 1.4 | 55 | 09.98 - 05.00 | AKQ | 4 | | BKUR6ET-10 | 2397 | 24 | LPG 1 | 1496 |
| Bora 16V | 1.4 | 55 | 05.99 - 05.00 | APE | 4 | | BKUR6ET-10 | 2397 | 24 | LPG 1 | 1496 |
| Bora 16V | 1.6 | 77 | 09.00 - 11.01 | AZD | 4 | 1,1 | PZFR6J-11 | 3586 | | LPG 6 | 1565 |
| Bora AUTOMATIC | 1.4 | 55 | 05.00 - 10.01 | AXP | 4 | 1,1 | PZFR5D-11 | 7968 | 34 | LPG 6 | 1565 |
| Bora FSI | 1.6 | 81 | 08.01 - 05.05 | BAD | 4 | | ZFR6S-Q | 6449 | | ZFR6S-Q | 6449 |
| Bora SDI | 1.9 | 50 | 05.00 - 04.01 | AGP | 4 | ▣ | Y-732J | 5605 | | D-POWER 4 | 5605 |
| Bora SDI | 1.9 | 50 | 11.98 - 05.05 | AQM | 4 | ▣ | Y-732J | 5605 | | D-POWER 4 | 5605 |
| Bora TDI | 1.9 | 66 | 10.98 - 09.02 | AGR | 4 | ▣ | Y-732J | 5605 | | D-POWER 4 | 5605 |
| Bora TDI | 1.9 | 66 | 09.98 - 05.03 | ALH | 4 | ▣ | Y-732J | 5605 | | D-POWER 4 | 5605 |
| Bora TDI | 1.9 | 81 | 09.98 - 05.05 | AHF | 4 | ▣ | Y-732J | 5605 | | D-POWER 4 | 5605 |
| Bora TDI | 1.9 | 81 | 05.00 - 05.05 | ASV | 4 | ▣ | Y-732J | 5605 | | D-POWER 4 | 5605 |
| Bora TDI | 1.9 | 85 | 11.98 - 07.01 | AJM | 4 | ▣ | Y-732J | 5605 | | D-POWER 4 | 5605 |
| Bora TDI | 1.9 | 85 | 05.00 - 07.01 | AUY | 4 | ▣ | Y-732J | 5605 | | D-POWER 4 | 5605 |
| Bora TDI Fgst → 1J-2-600000 | 1.9 | 74 | 05.00 - 05.05 | ATD | 4 | ▣ | Y-732J | 5605 | | D-POWER 4 | 5605 |
| Bora TDI Fgst → 1J-2-600000 | 1.9 | 74 | 05.01 - 05.05 | AXR | 4 | ▣ | Y-732J | 5605 | | D-POWER 4 | 5605 |
| Bora TDI Fgst → 1J-2-600000 | 1.9 | 96 | 04.01 - 05.05 | ASZ | 4 | ▣ | Y-732J | 5605 | | D-POWER 4 | 5605 |
| Bora TDI Fgst → 1J-2-600000 | 1.9 | 110 | 09.00 - 05.05 | ARL | 4 | ▣ | Y-732J | 5605 | | D-POWER 4 | 5605 |
| Bora TDI Fgst 1J-2-600001 → | 1.9 | 74 | 05.00 - 05.05 | ATD | 4 | ▣ | Y-741U | 6943 | | D-POWER 20 | 6943 |
| Bora TDI Fgst 1J-2-600001 → | 1.9 | 74 | 05.01 - 05.05 | AXR | 4 | ▣ | Y-741U | 6943 | | D-POWER 20 | 6943 |
| Bora TDI Fgst 1J-2-600001 → | 1.9 | 96 | 04.01 - 05.05 | ASZ | 4 | ▣ | Y-741U | 6943 | | D-POWER 20 | 6943 |
| Bora TDI Fgst 1J-2-600001 → | 1.9 | 110 | 09.00 - 05.05 | ARL | 4 | ▣ | Y-741U | 6943 | | D-POWER 20 | 6943 |
| Bora Turbo China | 1.8 | 110 | | BAE | 4 | 0,8 | PFR6Q | 6458 | 37 | LPG 1 | 1496 |
| Bora VR6 | 2.8 | 150 | 05.99 - 05.00 | AQP | 6 | 1,1 | PZFR5D-11 | 7968 | 34 | LPG 6 | 1565 |
| Bora VR6 | 2.8 | 150 | 05.00 - 04.01 | AUE | 6 | 1,1 | PZFR5D-11 | 7968 | 34 | LPG 6 | 1565 |
| Caddy | 1.4 | 44 | 11.95 - 12.97 | AEX | 4 | | BUR6ET | 3172 | 1 | LPG 2 | 1497 |
| Caddy | 1.4 | 44 | 11.97 - 09.00 | AKV | 4 | | BUR6ET | 3172 | 1 | LPG 2 | 1497 |
| Caddy | 1.4 | 44 | 12.97 - 06.03 | APQ | 4 | | BUR6ET | 3172 | 1 | LPG 2 | 1497 |
| Caddy | 1.4 | 44 | 09.00 - 06.03 | AUD | 4 | 1,1 | PZFR5D-11 | 7968 | 34 | LPG 6 | 1565 |
| Caddy | 1.4 | 55 | 09.00 - 06.03 | AUA | 4 | | BKUR6ET-10 | 2397 | 24 | LPG 1 | 1496 |
| Caddy | 1.4 | 55 | 02.04 - 05.06 | BCA | 4 | | BKUR6ET-10 | 2397 | 24 | LPG 1 | 1496 |
| Caddy | 1.4 | 59 | 05.06 - | BUD | 4 | 1,1 | ZFR6T-11G | 5960 | | ZFR6T-11G | 5960 |
| Caddy | 1.5 | 51 | 10.82 - 10.83 | JB | 4 | 0,7 | BP6ES | 7811 | 4 | LPG 2 | 1497 |
| Caddy | 1.6 | 40 | 10.82 - 07.90 | JK | 4 | ▣ | Y-918J | 6285 | | D-POWER 2 | 6285 |
| Caddy | 1.6 | 40 | 08.90 - 07.92 | ME | 4 | ▣ | Y-918J | 6285 | | D-POWER 2 | 6285 |
| Caddy | 1.6 | 55 | 11.95 - 05.97 | 1F | 4 | | BUR5ET | 3377 | 22 | LPG 2 | 1497 |
| Caddy | 1.6 | 55 | 10.82 - 10.83 | EM | 4 | 0,7 | BP6ES | 7811 | 4 | LPG 2 | 1497 |
| Caddy | 1.6 | 55 | 11.83 - 07.91 | EW | 4 | 0,7 | BP6ES | 7811 | 4 | LPG 2 | 1497 |
| Caddy | 1.6 | 55 | 08.83 - 07.89 | HN | 4 | 0,7 | BP6ES | 7811 | 4 | LPG 2 | 1497 |

Fgst = Chassis No.



ℓ kW

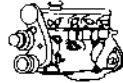

Cyl.

Order-
No.VLINE
No.LPG/CNG
D-PowerOrder-
No.**VW**

| | | | | | | | | | | | |
|--------------|-----|-----|---------------|------|---|-----|------------|------|----|------------|------|
| Caddy | 1.6 | 75 | 04.04 - 05.05 | BGU | 4 | | BKUR6ET-10 | 2397 | 24 | LPG 1 | 1496 |
| Caddy | 1.6 | 75 | 06.05 - | BSE | 4 | | BKUR6ET-10 | 2397 | 24 | LPG 1 | 1496 |
| Caddy | 1.6 | 75 | 06.05 - | BSF | 4 | | BKUR6ET-10 | 2397 | 24 | LPG 1 | 1496 |
| Caddy | 1.7 | 42 | 07.96 - 09.00 | AHB | 4 | ▣ | Y-918J | 6285 | | D-POWER 2 | 6285 |
| Caddy | 1.8 | 70 | 08.85 - 07.92 | JH | 4 | | BUR6ET | 3172 | 1 | LPG 2 | 1497 |
| Caddy | 1.9 | 47 | 11.95 - 06.03 | 1Y | 4 | ▣ | Y-918J | 6285 | | D-POWER 2 | 6285 |
| Caddy | 1.9 | 47 | 06.96 - 12.00 | AEF | 4 | ▣ | Y-918J | 6285 | | D-POWER 2 | 6285 |
| Caddy | 2.0 | 80 | 04.06 - | BSX | 4 | 0,9 | BKR6E | 6962 | 28 | LPG 1 | 1496 |
| Caddy China | 1.6 | 74 | 05 - | BRY | 4 | 0,9 | BKR6E | 6962 | 28 | LPG 1 | 1496 |
| Caddy SDI | 1.9 | 47 | 11.95 - 09.00 | AEY | 4 | ▣ | Y-732J | 5605 | | D-POWER 4 | 5605 |
| Caddy SDI | 1.9 | 47 | 09.00 - 06.03 | AYQ | 4 | ▣ | Y-732J | 5605 | | D-POWER 4 | 5605 |
| Caddy SDI | 2.0 | 52 | 02.04 - | BDJ | 4 | ▣ | Y-741U | 6943 | | D-POWER 20 | 6943 |
| Caddy SDI | 2.0 | 52 | 06.05 - | BST | 4 | ▣ | Y-741U | 6943 | | D-POWER 20 | 6943 |
| Caddy TDI | 1.9 | 55 | 09.05 - | BSU | 4 | ▣ | Y-607AS | 7560 | | D-POWER 50 | 7560 |
| Caddy TDI | 1.9 | 66 | 10.96 - 09.00 | AHU | 4 | ▣ | Y-732J | 5605 | | D-POWER 4 | 5605 |
| Caddy TDI | 1.9 | 66 | 09.97 - 09.00 | ALE | 4 | ▣ | Y-732J | 5605 | | D-POWER 4 | 5605 |
| Caddy TDI | 1.9 | 66 | 09.00 - 06.03 | ALH | 4 | ▣ | Y-732J | 5605 | | D-POWER 4 | 5605 |
| Caddy TDI | 1.9 | 77 | 02.04 - | BJB | 4 | ▣ | Y-607AS | 7560 | | D-POWER 50 | 7560 |
| Caddy TDI | 1.9 | 77 | 06.05 - | BLS | 4 | ▣ | Y-607AS | 7560 | | D-POWER 50 | 7560 |
| Caddy TDI | 2.0 | 103 | 09.07 - | BMM | 4 | ▣ | Y-607AS | 7560 | | D-POWER 50 | 7560 |
| Caddy Pickup | 1.6 | 55 | 06.96 - 12.00 | AEE | 4 | | BUR6ET | 3172 | 1 | LPG 2 | 1497 |
| Corrado | 2.0 | 85 | 04.93 - 09.94 | 2E | 4 | | BUR6ET | 3172 | 1 | LPG 2 | 1497 |
| Corrado | 2.0 | 85 | 07.94 - 07.95 | ADY | 4 | | BUR6ET | 3172 | 1 | LPG 2 | 1497 |
| Corrado | 2.0 | 100 | 08.91 - 07.95 | 9A | 4 | | BKUR7ET | 7873 | | PFR7Q | 7963 |
| Corrado 16V | 1.8 | 98 | 04.89 - 07.92 | KR | 4 | | BCPR7ET | 2164 | | BCPR7EIX | 5690 |
| Corrado G60 | 1.8 | 118 | 09.88 - 07.93 | PG | 4 | | only OES | | | | |
| Corrado VR6 | 2.8 | 128 | 08.91 - 01.96 | AAA | 6 | | BKR5EKUP | 2890 | | | |
| Corrado VR6 | 2.8 | 132 | 07.95 - 01.96 | AAA | 6 | | BKR5EKUP | 2890 | | | |
| Corrado VR6 | 2.8 | 132 | 08.91 - 06.95 | AAA | 6 | | BKR5EKU | 3964 | | | |
| Corrado VR6 | 2.9 | 140 | 08.91 - 07.95 | ABV | 6 | | BKR5EKU | 3964 | | | |
| Crafter | 2.5 | 65 | 04.06 - | BJJ | 5 | ▣ | CZ104 | 9826 | | D-POWER 52 | 9826 |
| Crafter TDI | 2.5 | 80 | 04.06 - | BJK | 5 | ▣ | CZ104 | 9826 | | D-POWER 52 | 9826 |
| Crafter TDI | 2.5 | 100 | 04.06 - | BJL | 5 | ▣ | CZ104 | 9826 | | D-POWER 52 | 9826 |
| Crafter TDI | 2.5 | 120 | 04.06 - | BJM | 5 | ▣ | CZ104 | 9826 | | D-POWER 52 | 9826 |
| Eos FSI | 1.4 | 90 | 11.07 - | CAXA | 4 | 0,9 | PZFR6R | 5758 | | PZFR6R | 5758 |
| Eos FSI | 1.6 | 85 | 05.06 - 05.08 | BLF | 4 | | ZFR6S-Q | 6449 | | ZFR6S-Q | 6449 |
| Eos FSI | 2.0 | 110 | 05.06 - 05.08 | BVY | 4 | | PZFR5N-11T | 7742 | | PZFR5N-11T | 7742 |
| Eos FSI | 2.0 | 110 | 05.06 - 05.08 | BVZ | 4 | 0,9 | BKR6E | 6962 | 28 | LPG 1 | 1496 |
| Eos TDI | 2.0 | 103 | 05.06 - 05.08 | BMM | 4 | ▣ | Y-607AS | 7560 | | D-POWER 50 | 7560 |
| Eos TFSI | 1.4 | 118 | 05.08 - | CAVD | 4 | 0,9 | PZFR6R | 5758 | | PZFR6R | 5758 |
| Eos TFSI | 2.0 | 125 | 11.09 - | CCZB | 4 | 0,8 | PFR7S8EG | 1675 | | | |
| Eos TFSI | 2.0 | 147 | 05.09 - | CCZA | 4 | 0,8 | PFR7S8EG | 1675 | | | |
| Eos V6 | 3.2 | 184 | 05.06 - | BUB | 6 | 0,9 | IZKR7B | 7563 | | IZKR7B | 7563 |
| Eos FSI | 2.0 | 147 | 05.08 - | BPY | 4 | 0,8 | PFR7S8EG | 1675 | | | |
| Eos TDI | 2.0 | 100 | 11.10 - | CFHB | 4 | ▣ | Y1002AS | 8888 | | D-POWER 57 | 8888 |
| Eos TDI | 2.0 | 103 | 05.08 - 11.10 | CBAB | 4 | ▣ | Y-609AS | 5849 | | D-POWER 49 | 5849 |
| Eos TDI | 2.0 | 103 | 11.10 - | CFHC | 4 | ▣ | Y1002AS | 8888 | | D-POWER 57 | 8888 |
| Eos TFSI | 2.0 | 147 | 05.06 - | BWA | 4 | 0,8 | PFR7S8EG | 1675 | | | |
| Eos TFSI | 2.0 | 147 | 05.08 - | CAWB | 4 | 0,8 | PFR7S8EG | 1675 | | | |
| Eos TFSI | 2.0 | 147 | 11.07 - | CCTA | 4 | 0,8 | PFR7S8EG | 1675 | | | |
| Fox | 1.2 | 40 | 09.05 - | BMD | 3 | 0,9 | ZFR5P-G | 6893 | | LPG 6 | 1565 |
| Fox | 1.4 | 55 | 09.05 - | BKR | 4 | 1,1 | PZFR5D-11 | 7968 | 34 | LPG 6 | 1565 |



ℓ kW



Cyl.

Order-
No. No.LPG/CNG
D-PowerOrder-
No.**VW**

| | | | | | | | | | | | |
|----------------------|-----|-----|---------------|-----|---|-----|-----------|------|----|------------|------|
| Fox TDI | 1.4 | 51 | 09.05 - | BNM | 3 | █ | Y-741U | 6943 | | D-POWER 20 | 6943 |
| Gol China | 1.6 | 64 | | BHJ | 4 | 0,8 | BP5ES | 6511 | 8 | LPG 2 | 1497 |
| Golf 1 D,TD | 1.6 | 40 | 08.80 - 10.91 | | 4 | █ | Y-918J | 6285 | | D-POWER 2 | 6285 |
| Golf 1/ Jetta | 1.3 | 43 | 08.82 - 12.83 | GS | 4 | 0,7 | BP6ES | 7811 | 4 | LPG 2 | 1497 |
| Golf 1/ Jetta | 1.6 | 40 | 08.80 - 07.82 | CR | 4 | █ | Y-918J | 6285 | | D-POWER 2 | 6285 |
| Golf 1/ Jetta | 1.6 | 40 | 08.82 - 12.84 | JK | 4 | █ | Y-918J | 6285 | | D-POWER 2 | 6285 |
| Golf 1/ Jetta | 1.8 | 82 | 08.82 - 07.83 | DX | 4 | | BUR6ET | 3172 | 1 | LPG 2 | 1497 |
| Golf 1/ Jetta | 1.8 | 82 | 08.82 - 02.84 | JJ | 4 | | BUR6ET | 3172 | 1 | LPG 2 | 1497 |
| Golf 1/ Jetta TD | 1.6 | 51 | 03.82 - 12.83 | CY | 4 | █ | Y-918J | 6285 | | D-POWER 2 | 6285 |
| Golf 2 | 1.8 | 70 | 08.83 - 07.93 | JH | 4 | | BUR6ET | 3172 | 1 | LPG 2 | 1497 |
| Golf 2 D,TD | 1.6 | 40 | 01.84 - 10.91 | | 4 | █ | Y-918J | 6285 | | D-POWER 2 | 6285 |
| Golf 2 / Jetta | 1.6 | 53 | 07.91 - 07.92 | ABX | 4 | | BP5ET-10 | 5156 | | | |
| Golf 2 / Jetta | 1.6 | 53 | 04.86 - 07.90 | RE | 4 | | BUR5ET-10 | 7264 | 21 | LPG 2 | 1497 |
| Golf 2 / Jetta China | 1.6 | 53 | | ANL | 4 | | BUR6ET | 3172 | 1 | LPG 2 | 1497 |
| Golf 2 / Jetta China | 1.6 | 74 | | AHP | 4 | | BKR5E | 7938 | 35 | LPG 1 | 1496 |
| Golf 2 / Jetta China | 1.6 | 53 | - 99 | ACR | 4 | | BUR6ET | 3172 | 1 | LPG 2 | 1497 |
| Golf 2 / Jetta China | 1.6 | 64 | | ATK | 4 | 0,8 | BKR5E | 7938 | 35 | LPG 1 | 1496 |
| Golf 2/ G60 | 1.8 | 118 | 08.88 - 07.91 | PG | 4 | | only OES | | | | |
| Golf 2/ Jetta | 1.0 | 37 | 05.85 - 08.88 | HZ | 4 | | BUR6ET | 3172 | 1 | LPG 2 | 1497 |
| Golf 2/ Jetta | 1.0 | 37 | 08.88 - 07.89 | HZ | 4 | 0,7 | BP6ESZ | 7639 | | LPG 2 | 1497 |
| Golf 2/ Jetta | 1.0 | 37 | 08.89 - 10.91 | HZ | 4 | | BUR6ET | 3172 | 1 | LPG 2 | 1497 |
| Golf 2/ Jetta | 1.3 | 37 | 08.85 - 12.87 | NU | 4 | | BUR6ET | 3172 | 1 | LPG 2 | 1497 |
| Golf 2/ Jetta | 1.3 | 40 | 01.89 - 07.92 | 2G | 4 | | BUR6ET | 3172 | 1 | LPG 2 | 1497 |
| Golf 2/ Jetta | 1.3 | 40 | 08.83 - 07.86 | HK | 4 | 0,7 | BP6ES | 7811 | 4 | LPG 2 | 1497 |
| Golf 2/ Jetta | 1.3 | 40 | 08.85 - 08.88 | MH | 4 | | BUR6ET | 3172 | 1 | LPG 2 | 1497 |
| Golf 2/ Jetta | 1.3 | 40 | 08.88 - 07.89 | MH | 4 | 0,7 | BP6ESZ | 7639 | | LPG 2 | 1497 |
| Golf 2/ Jetta | 1.3 | 40 | 08.89 - 08.91 | MH | 4 | | BUR6ET | 3172 | 1 | LPG 2 | 1497 |
| Golf 2/ Jetta | 1.3 | 40 | 08.85 - 08.88 | NZ | 4 | | BUR6ET | 3172 | 1 | LPG 2 | 1497 |
| Golf 2/ Jetta | 1.3 | 40 | 08.88 - 07.89 | NZ | 4 | 0,7 | BP6ESZ | 7639 | | LPG 2 | 1497 |
| Golf 2/ Jetta | 1.3 | 40 | 08.89 - 07.92 | NZ | 4 | | BUR6ET | 3172 | 1 | LPG 2 | 1497 |
| Golf 2/ Jetta | 1.3 | 44 | 08.85 - 08.88 | 2C | 4 | | BUR6ET | 3172 | 1 | LPG 2 | 1497 |
| Golf 2/ Jetta | 1.6 | 44 | 08.89 - 07.92 | 1V | 4 | █ | Y-918J | 6285 | | D-POWER 2 | 6285 |
| Golf 2/ Jetta | 1.6 | 51 | 08.85 - 07.87 | EZA | 4 | | BUR5ET-10 | 7264 | 21 | LPG 2 | 1497 |
| Golf 2/ Jetta | 1.6 | 51 | 08.85 - 07.92 | PN | 4 | | BUR5ET-10 | 7264 | 21 | LPG 2 | 1497 |
| Golf 2/ Jetta | 1.6 | 53 | 08.86 - 10.91 | RF | 4 | | BUR5ET-10 | 7264 | 21 | LPG 2 | 1497 |
| Golf 2/ Jetta | 1.6 | 55 | 08.86 - 07.92 | ABN | 4 | | BUR5ET-10 | 7264 | 21 | LPG 2 | 1497 |
| Golf 2/ Jetta | 1.6 | 55 | 08.83 - 07.92 | EW | 4 | | BUR5ET-10 | 7264 | 21 | LPG 2 | 1497 |
| Golf 2/ Jetta | 1.6 | 55 | 08.83 - 07.91 | EZ | 4 | | BUR5ET-10 | 7264 | 21 | LPG 2 | 1497 |
| Golf 2/ Jetta | 1.6 | 55 | 08.83 - 07.88 | HM | 4 | | BUR5ET-10 | 7264 | 21 | LPG 2 | 1497 |
| Golf 2/ Jetta | 1.6 | 55 | 08.83 - 07.86 | HN | 4 | | BUR5ET-10 | 7264 | 21 | LPG 2 | 1497 |
| Golf 2/ Jetta | 1.6 | 59 | 08.89 - 10.91 | SB | 4 | █ | Y-918J | 6285 | | D-POWER 2 | 6285 |
| Golf 2/ Jetta | 1.8 | 62 | 08.86 - 07.87 | RH | 4 | | BUR6ET | 3172 | 1 | LPG 2 | 1497 |
| Golf 2/ Jetta | 1.8 | 62 | 08.87 - 07.89 | RH | 4 | 0,7 | BP6ESZ | 7639 | | LPG 2 | 1497 |
| Golf 2/ Jetta | 1.8 | 62 | 08.89 - 07.90 | RH | 4 | | BUR6ET | 3172 | 1 | LPG 2 | 1497 |
| Golf 2/ Jetta | 1.8 | 66 | 08.83 - 07.93 | EX | 4 | | BUR6ET | 3172 | 1 | LPG 2 | 1497 |
| Golf 2/ Jetta | 1.8 | 66 | 08.83 - 10.91 | GU | 4 | | BUR6ET | 3172 | 1 | LPG 2 | 1497 |
| Golf 2/ Jetta | 1.8 | 66 | 08.84 - 07.85 | GX | 4 | | BUR6ET | 3172 | 1 | LPG 2 | 1497 |
| Golf 2/ Jetta | 1.8 | 66 | 08.84 - 07.85 | HV | 4 | | BUR6ET | 3172 | 1 | LPG 2 | 1497 |
| Golf 2/ Jetta | 1.8 | 66 | 01.84 - 10.91 | RP | 4 | | BUR6ET | 3172 | 1 | LPG 2 | 1497 |
| Golf 2/ Jetta | 1.8 | 72 | 08.88 - 07.91 | 1P | 4 | | BUR6ET | 3172 | 1 | LPG 2 | 1497 |
| Golf 2/ Jetta | 1.8 | 72 | 08.89 - 07.93 | 2H | 4 | | BUR6ET | 3172 | 1 | LPG 2 | 1497 |
| Golf 2/ Jetta | 1.8 | 77 | 01.85 - 07.85 | HT | 4 | | BUR6ET | 3172 | 1 | LPG 2 | 1497 |



ℓ kW

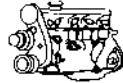

Cyl.

Order-
No.VLINE
No.LPG/CNG
D-PowerOrder-
No.**VW**

| | | | | | | | | | | | |
|------------------------|-----|-----|-------------|-----|---|-----|------------|------|----|-----------|------|
| Golf 2/ Jetta | 1.8 | 77 | 08.85-07.87 | RD | 4 | | BUR6ET | 3172 | 1 | LPG 2 | 1497 |
| Golf 2/ Jetta | 1.8 | 77 | 08.87-10.91 | RV | 4 | | BUR6ET | 3172 | 1 | LPG 2 | 1497 |
| Golf 2/ Jetta | 1.8 | 79 | 01.87-10.91 | PF | 4 | | BUR6ET | 3172 | 1 | LPG 2 | 1497 |
| Golf 2/ Jetta | 1.8 | 79 | 08.85-07.88 | RG | 4 | | BUR6ET | 3172 | 1 | LPG 2 | 1497 |
| Golf 2/ Jetta | 1.8 | 82 | 01.84-07.85 | EV | 4 | | BUR6ET | 3172 | 1 | LPG 2 | 1497 |
| Golf 2/ Jetta | 1.8 | 82 | 01.84-07.88 | GZ | 4 | | BUR6ET | 3172 | 1 | LPG 2 | 1497 |
| Golf 2/ Jetta | 1.8 | 82 | 08.83-07.89 | KT | 4 | | BUR6ET | 3172 | 1 | LPG 2 | 1497 |
| Golf 2/ Jetta | 1.8 | 82 | 01.87-10.91 | PB | 4 | | BUR6ET | 3172 | 1 | LPG 2 | 1497 |
| Golf 2/ Jetta | 1.8 | 95 | 02.86-10.91 | PL | 4 | | BKUR7ET | 7873 | | PFR7Q | 7963 |
| Golf 2/ Jetta | 1.8 | 102 | 02.86-10.91 | KR | 4 | | BCPR7ET | 2164 | | BCPR7EIX | 5690 |
| Golf 2/ Jetta (USA) | 2.0 | 100 | 07.89-07.92 | 9A | 4 | | BKUR7ET | 7873 | | PFR7Q | 7963 |
| Golf 3 | 1.9 | 47 | 07.95-02.99 | AEY | 4 | ■ | Y-732J | 5605 | | D-POWER 4 | 5605 |
| Golf 3 SDI | 1.9 | 47 | 11.91-08.98 | 1Y | 4 | ■ | Y-918J | 6285 | | D-POWER 2 | 6285 |
| Golf 3 TD | 1.9 | 55 | 11.91-08.98 | AAZ | 4 | ■ | Y-918J | 6285 | | D-POWER 2 | 6285 |
| Golf 3 TDI | 1.9 | 66 | 07.93-07.96 | 1Z | 4 | ■ | Y-732J | 5605 | | D-POWER 4 | 5605 |
| Golf 3 TDI | 1.9 | 66 | 07.96-06.00 | AHU | 4 | ■ | Y-732J | 5605 | | D-POWER 4 | 5605 |
| Golf 3 TDI | 1.9 | 81 | 02.96-08.99 | AFN | 4 | ■ | Y-732J | 5605 | | D-POWER 4 | 5605 |
| Golf 3 Cabrio | 2.3 | 125 | 04.00- | | 5 | 1,1 | PZFR5D-11 | 7968 | 34 | LPG 6 | 1565 |
| Golf 3 only Cab.&Vari. | 1.8 | 66 | 12.97-10.00 | ANP | 4 | | BUR6ET | 3172 | 1 | LPG 2 | 1497 |
| Golf 3 Syncro / VR6 | 2.9 | 140 | 10.94-12.97 | ABV | 6 | | BKR5EKU | 3964 | | | |
| Golf 3/ Jetta (USA) | 2.0 | 85 | 03.92-07.95 | ABA | 4 | | BKR5EVX | 2546 | | LPG 1 | 1496 |
| Golf 3/ Vento | 1.4 | 44 | 11.91-07.95 | ABD | 4 | | BUR5ET | 3377 | 22 | LPG 2 | 1497 |
| Golf 3/ Vento | 1.4 | 44 | 07.95-12.97 | AEX | 4 | | BUR6ET | 3172 | 1 | LPG 2 | 1497 |
| Golf 3/ Vento | 1.6 | 55 | 08.92-09.94 | ABU | 4 | | BUR6ET | 3172 | 1 | LPG 2 | 1497 |
| Golf 3/ Vento | 1.6 | 55 | 10.94-07.95 | AEA | 4 | | BUR6ET | 3172 | 1 | LPG 2 | 1497 |
| Golf 3/ Vento | 1.6 | 55 | 07.95-12.97 | AEE | 4 | | BUR6ET | 3172 | 1 | LPG 2 | 1497 |
| Golf 3/ Vento | 1.6 | 74 | 10.94-12.95 | AEK | 4 | | BKUR5ET | 2789 | 29 | LPG 1 | 1496 |
| Golf 3/ Vento | 1.6 | 74 | 01.96-10.00 | AFT | 4 | | BKUR6ET-10 | 2397 | 24 | LPG 1 | 1496 |
| Golf 3/ Vento | 1.6 | 74 | 04.97-10.00 | AKS | 4 | | BKUR5ET | 2789 | 29 | LPG 1 | 1496 |
| Golf 3/ Vento | 1.8 | 55 | 07.91-10.00 | AAM | 4 | | BUR5ET | 3377 | 22 | LPG 2 | 1497 |
| Golf 3/ Vento | 1.8 | 55 | 12.97-10.00 | ANN | 4 | | BUR5ET | 3377 | 22 | LPG 2 | 1497 |
| Golf 3/ Vento | 1.8 | 66 | 11.91-07.95 | ABS | 4 | | BUR6ET | 3172 | 1 | LPG 2 | 1497 |
| Golf 3/ Vento | 1.8 | 66 | 08.91-12.97 | ACC | 4 | | BUR6ET | 3172 | 1 | LPG 2 | 1497 |
| Golf 3/ Vento | 1.8 | 66 | 01.98- | ADD | 4 | | BUR6ET | 3172 | 1 | LPG 2 | 1497 |
| Golf 3/ Vento | 1.8 | 66 | 10.94-10.00 | ADZ | 4 | | BUR6ET | 3172 | 1 | LPG 2 | 1497 |
| Golf 3/ Vento | 2.0 | 85 | 11.91-09.94 | 2E | 4 | | BUR6ET | 3172 | 1 | LPG 2 | 1497 |
| Golf 3/ Vento | 2.0 | 85 | 10.94-05.96 | ADY | 4 | | BUR6ET | 3172 | 1 | LPG 2 | 1497 |
| Golf 3/ Vento | 2.0 | 85 | 07.95-12.01 | AGG | 4 | | BUR6ET | 3172 | 1 | LPG 2 | 1497 |
| Golf 3/ Vento | 2.0 | 85 | 04.97-04.00 | AKR | 4 | | BUR6ET | 3172 | 1 | LPG 2 | 1497 |
| Golf 3/ Vento (GUS) | 2.0 | 79 | 01.95-12.97 | AEP | 4 | | BUR6ET | 3172 | 1 | LPG 2 | 1497 |
| Golf 3/ Vento (USA) | 2.0 | 85 | 02.94-07.98 | ADC | 4 | | BKR5EVX | 2546 | | LPG 1 | 1496 |
| Golf 3/ Vento / VR6 | 2.8 | 128 | 01.92-06.95 | AAA | 6 | | BKR5EKU | 3964 | | | |
| Golf 3/ Vento / VR6 | 2.8 | 128 | 07.95-12.97 | AAA | 6 | | BKR5EKUP | 2890 | | | |
| Golf 3/ Vento 16V | 2.0 | 110 | 08.92-07.94 | ABF | 4 | | BKUR6ET-10 | 2397 | 24 | LPG 1 | 1496 |
| Golf 3/ Vento TDI | 1.9 | 66 | 05.96-12.01 | ALE | 4 | ■ | Y-732J | 5605 | | D-POWER 4 | 5605 |
| Golf 4 | 1.4 | 44 | 12.97-05.98 | APQ | 4 | | BUR6ET | 3172 | 1 | LPG 2 | 1497 |
| Golf 4 | 1.4 | 55 | 10.97-06.06 | AHW | 4 | | BKUR6ET-10 | 2397 | 24 | LPG 1 | 1496 |
| Golf 4 | 1.4 | 55 | 10.97-05.00 | AKQ | 4 | | BKUR6ET-10 | 2397 | 24 | LPG 1 | 1496 |
| Golf 4 | 1.4 | 55 | 05.99-05.00 | APE | 4 | | BKUR6ET-10 | 2397 | 24 | LPG 1 | 1496 |
| Golf 4 | 1.4 | 55 | 10.01-06.06 | BCA | 4 | | BKUR6ET-10 | 2397 | 24 | LPG 1 | 1496 |
| Golf 4 | 1.6 | 74 | 01.98-05.04 | AEH | 4 | | BKUR6ET-10 | 2397 | 24 | LPG 1 | 1496 |
| Golf 4 | 1.6 | 74 | 10.97-05.03 | AKL | 4 | | BKUR6ET-10 | 2397 | 24 | LPG 1 | 1496 |



ℓ kW



Cyl.

Order-
No. No.LPG/CNG
D-PowerOrder-
No.**VW**

| | | | | | | | | | | | |
|---------------------------------|-----|-----|---------------|-----|---|-----|------------|------|----|------------|------|
| Golf 4 | 1.6 | 74 | 05.99 - 08.00 | APF | 4 | | BKUR6ET-10 | 2397 | 24 | LPG 1 | 1496 |
| Golf 4 | 1.6 | 74 | 09.00 - 04.02 | AVU | 4 | | BKUR6ET-10 | 2397 | 24 | LPG 1 | 1496 |
| Golf 4 | 1.6 | 75 | 05.02 - 06.06 | BFQ | 4 | | BKUR6ET-10 | 2397 | 24 | LPG 1 | 1496 |
| Golf 4 | 1.6 | 77 | 11.99 - 05.00 | ATN | 4 | | BKUR6ET-10 | 2397 | 24 | LPG 1 | 1496 |
| Golf 4 | 1.6 | 77 | 05.00 - 10.00 | AUS | 4 | | BKUR6ET-10 | 2397 | 24 | LPG 1 | 1496 |
| Golf 4 | 1.6 | 77 | 09.00 - 11.01 | AZD | 4 | 1,1 | PZFR6J-11 | 3586 | | LPG 6 | 1565 |
| Golf 4 | 1.6 | 77 | 11.01 - 06.06 | BCB | 4 | 1,1 | PZFR6J-11 | 3586 | | LPG 6 | 1565 |
| Golf 4 | 1.8 | 92 | 07.98 - 10.00 | AGN | 4 | | BKUR6ET-10 | 2397 | 24 | LPG 1 | 1496 |
| Golf 4 | 1.8 | 110 | 05.99 - 04.01 | ARZ | 4 | 0,8 | PFR6Q | 6458 | 37 | LPG 1 | 1496 |
| Golf 4 | 1.8 | 110 | 09.00 - 05.06 | AUM | 4 | 0,8 | PFR6Q | 6458 | 37 | LPG 1 | 1496 |
| Golf 4 | 1.9 | 66 | 10.97 - 09.02 | AGR | 4 | | Y-732J | 5605 | | D-POWER 4 | 5605 |
| Golf 4 | 1.9 | 85 | 05.99 - 07.01 | AJM | 4 | | Y-732J | 5605 | | D-POWER 4 | 5605 |
| Golf 4 | 2.0 | 85 | 08.98 - 05.03 | APK | 4 | | BKUR6ET-10 | 2397 | 24 | LPG 1 | 1496 |
| Golf 4 | 2.0 | 85 | 08.98 - 06.06 | AQY | 4 | | BKUR6ET-10 | 2397 | 24 | LPG 1 | 1496 |
| Golf 4 | 2.0 | 85 | 06.99 - 06.00 | ATU | 4 | 0,8 | PFR6Q | 6458 | 37 | LPG 1 | 1496 |
| Golf 4 | 2.0 | 85 | 05.01 - 04.02 | AZG | 4 | 1,1 | PZFR5D-11 | 7968 | 34 | LPG 6 | 1565 |
| Golf 4 | 2.0 | 85 | 04.00 - 06.01 | AZH | 4 | | BKUR6ET-10 | 2397 | 24 | LPG 1 | 1496 |
| Golf 4 | 2.0 | 85 | 05.01 - 06.06 | AZJ | 4 | 1,1 | PZFR5D-11 | 7968 | 34 | LPG 6 | 1565 |
| Golf 4 | 2.0 | 85 | 05.02 - 06.06 | BEH | 4 | 1,1 | PZFR5D-11 | 7968 | 34 | LPG 6 | 1565 |
| Golf 4 | 2.3 | 125 | 09.00 - 05.06 | AQN | 5 | 1,1 | PZFR5D-11 | 7968 | 34 | LPG 6 | 1565 |
| Golf 4 | 2.8 | 150 | 05.01 - 06.05 | BDE | 6 | 1,1 | PZFR5D-11 | 7968 | 34 | LPG 6 | 1565 |
| Golf 4 China | 1.6 | 74 | 11.05 - | BJH | 4 | 0,9 | BKR6E | 6962 | 28 | LPG 1 | 1496 |
| Golf 4 China | 1.6 | 78 | 04 - | AWB | 4 | 0,8 | BKR5E | 7938 | 35 | LPG 1 | 1496 |
| Golf 4 China | 1.8 | 92 | 09.05 - | BAF | 4 | | BKUR6ET-10 | 2397 | 24 | LPG 1 | 1496 |
| Golf 4 USA | 1.8 | 110 | 12.99 - 09.00 | AWD | 4 | 0,8 | PFR6Q | 6458 | 37 | LPG 1 | 1496 |
| Golf 4 USA | 2.0 | 85 | 06.98 - | AEG | 4 | | BKUR6ET-10 | 2397 | 24 | LPG 1 | 1496 |
| Golf 4 Automatic | 1.4 | 55 | 05.00 - 10.01 | AXP | 4 | 1,1 | PZFR5D-11 | 7968 | 34 | LPG 6 | 1565 |
| Golf 4 Cabrio | 2.0 | 85 | 06.00 - 06.02 | AWF | 4 | 0,8 | PFR6Q | 6458 | 37 | LPG 1 | 1496 |
| Golf 4 Cabrio | 2.0 | 85 | 06.00 - 06.02 | AWG | 4 | 0,8 | PFR6Q | 6458 | 37 | LPG 1 | 1496 |
| Golf 4 FSI | 1.6 | 81 | 08.01 - 06.06 | BAD | 4 | | ZFR6S-Q | 6449 | | ZFR6S-Q | 6449 |
| Golf 4 FSI | 1.6 | 85 | 10.03 - 07.04 | BAG | 4 | | ZFR6S-Q | 6449 | | ZFR6S-Q | 6449 |
| Golf 4 GTI | 1.8 | 110 | 10.97 - 05.03 | AGU | 4 | 0,8 | PFR6Q | 6458 | 37 | LPG 1 | 1496 |
| Golf 4 GTI | 1.8 | 132 | 06.01 - 05.04 | AUQ | 4 | 0,8 | PFR6Q | 6458 | 37 | LPG 1 | 1496 |
| Golf 4 R32 | 3.2 | 177 | 06.02 - 05.04 | BFH | 6 | 0,9 | IZKR7B | 7563 | | IZKR7B | 7563 |
| Golf 4 R32 | 3.2 | 177 | 11.03 - 06.06 | BML | 6 | 0,9 | IZKR7B | 7563 | | IZKR7B | 7563 |
| Golf 4 Schaltgetriebe / gearbox | 1.4 | 55 | 05.00 - 10.01 | AXP | 4 | | BKUR6ET-10 | 2397 | 24 | LPG 1 | 1496 |
| Golf 4 SDI | 1.9 | 50 | 10.97 - 04.01 | AGP | 4 | | Y-732J | 5605 | | D-POWER 4 | 5605 |
| Golf 4 SDI | 1.9 | 50 | 11.98 - 05.06 | AQM | 4 | | Y-732J | 5605 | | D-POWER 4 | 5605 |
| Golf 4 TDI | 1.9 | 66 | 10.97 - 05.03 | ALH | 4 | | Y-732J | 5605 | | D-POWER 4 | 5605 |
| Golf 4 TDI | 1.9 | 81 | 10.97 - 05.06 | AHF | 4 | | Y-732J | 5605 | | D-POWER 4 | 5605 |
| Golf 4 TDI | 1.9 | 81 | 05.00 - 05.06 | ASV | 4 | | Y-732J | 5605 | | D-POWER 4 | 5605 |
| Golf 4 TDI | 1.9 | 81 | 08.99 - 10.00 | AVG | 4 | | Y-732J | 5605 | | D-POWER 4 | 5605 |
| Golf 4 TDI | 1.9 | 85 | 01.00 - 07.01 | AUY | 4 | | Y-732J | 5605 | | D-POWER 4 | 5605 |
| Golf 4 TDI Fgst → 1J-2-60 0000 | 1.9 | 110 | 09.00 - 05.06 | ARL | 4 | | Y-732J | 5605 | | D-POWER 4 | 5605 |
| Golf 4 TDI Fgst → 1J-2-600000 | 1.9 | 74 | 02.00 - 06.06 | ATD | 4 | | Y-732J | 5605 | | D-POWER 4 | 5605 |
| Golf 4 TDI Fgst → 1J-2-600000 | 1.9 | 74 | 05.01 - 06.06 | AXR | 4 | | Y-732J | 5605 | | D-POWER 4 | 5605 |
| Golf 4 TDI Fgst → 1J-2-600000 | 1.9 | 96 | 04.01 - 05.06 | ASZ | 4 | | Y-732J | 5605 | | D-POWER 4 | 5605 |
| Golf 4 TDI Fgst 1J-2-600001 → | 1.9 | 74 | 02.00 - 06.06 | ATD | 4 | | Y-741U | 6943 | | D-POWER 20 | 6943 |
| Golf 4 TDI Fgst 1J-2-600001 → | 1.9 | 74 | 05.01 - 06.06 | AXR | 4 | | Y-741U | 6943 | | D-POWER 20 | 6943 |
| Golf 4 TDI Fgst 1J-2-600001 → | 1.9 | 96 | 04.01 - 05.06 | ASZ | 4 | | Y-741U | 6943 | | D-POWER 20 | 6943 |
| Golf 4 TDI Fgst 1J-2-600001 → | 1.9 | 110 | 09.00 - 05.06 | ARL | 4 | | Y-741U | 6943 | | D-POWER 20 | 6943 |
| Golf 4 USA | 1.8 | 110 | 08.00 - | AWW | 4 | 0,8 | PFR6Q | 6458 | 37 | LPG 1 | 1496 |

Fgst = Chassis No.



ℓ kW

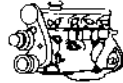

Cyl.

Order-
No.VLINE
No.LPG/CNG
D-PowerOrder-
No.**VW**

| | | | | | | | | | | | | |
|--------------------------|-----|-----|-------------|------|---|-----|------------|------|----|------------|------|--|
| Golf 4 USA | 2.8 | 130 | 03.98-05.00 | AFP | 6 | | BKR5EKUP | 2890 | | | | |
| Golf 4 V5 | 2.3 | 110 | 10.97-02.01 | AGZ | 5 | | BKR5EKUP | 2890 | | | | |
| Golf 4 VR6 | 2.8 | 150 | 05.99-05.00 | AQP | 6 | 1,1 | PZFR5D-11 | 7968 | 34 | LPG 6 | 1565 | |
| Golf 4 VR6 | 2.8 | 150 | 01.00-04.01 | AUE | 6 | 1,1 | PZFR5D-11 | 7968 | 34 | LPG 6 | 1565 | |
| Golf 5 | 1.4 | 55 | 01.05-05.06 | BCA | 4 | | BKUR6ET-10 | 2397 | 24 | LPG 1 | 1496 | |
| Golf 5 | 1.4 | 59 | 05.06- | BUD | 4 | 1,1 | ZFR6T-11G | 5960 | | ZFR6T-11G | 5960 | |
| Golf 5 | 1.4 | 59 | 10.08- | CGGA | 4 | 1,1 | ZFR6T-11G | 5960 | | ZFR6T-11G | 5960 | |
| Golf 5 | 1.6 | 75 | 01.04-06.05 | BGU | 4 | | BKUR6ET-10 | 2397 | 24 | LPG 1 | 1496 | |
| Golf 5 | 1.6 | 75 | 05.05- | BSE | 4 | | BKUR6ET-10 | 2397 | 24 | LPG 1 | 1496 | |
| Golf 5 | 1.6 | 75 | 05.05- | BSF | 4 | | BKUR6ET-10 | 2397 | 24 | LPG 1 | 1496 | |
| Golf 5 | 1.6 | 75 | 11.07-12.08 | CCSA | 4 | | BKUR6ET-10 | 2397 | 24 | LPG 1 | 1496 | |
| Golf 5 | 1.9 | 77 | 10.03-05.06 | BKC | 4 | ■ | Y-607AS | 7560 | | D-POWER 50 | 7560 | |
| Golf 5 | 2.0 | 85 | 09.07- | CBPA | 4 | | BKUR6ET-10 | 2397 | 24 | LPG 1 | 1496 | |
| Golf 5 | 2.0 | 100 | 10.03-05.07 | AZV | 4 | ■ | YE14 | 7768 | | D-POWER 48 | 7768 | |
| Golf 5 | 2.0 | 103 | 07.08- | CBDA | 4 | ■ | Y1002AS | 8888 | | D-POWER 57 | 8888 | |
| Golf 5 | 2.0 | 103 | 02.08- | CBDB | 4 | ■ | Y1002AS | 8888 | | D-POWER 57 | 8888 | |
| Golf 5 FSI | 1.4 | 66 | 10.03-12.04 | BKG | 4 | | ZFR6S-Q | 6449 | | ZFR6S-Q | 6449 | |
| Golf 5 FSI | 1.4 | 66 | 11.04-07.06 | BLN | 4 | | ZFR6S-Q | 6449 | | ZFR6S-Q | 6449 | |
| Golf 5 FSI | 1.6 | 85 | 10.03-07.04 | BAG | 4 | | ZFR6S-Q | 6449 | | ZFR6S-Q | 6449 | |
| Golf 5 FSI | 1.6 | 85 | 01.05-01.09 | BLF | 4 | | ZFR6S-Q | 6449 | | ZFR6S-Q | 6449 | |
| Golf 5 FSI | 1.6 | 85 | 05.04-07.05 | BLP | 4 | | ZFR6S-Q | 6449 | | ZFR6S-Q | 6449 | |
| Golf 5 FSI | 2.0 | 110 | 10.03-05.04 | AXW | 4 | | PZFR5N-11T | 7742 | | PZFR5N-11T | 7742 | |
| Golf 5 FSI | 2.0 | 110 | 01.05-07.07 | BLR | 4 | | PZFR5N-11T | 7742 | | PZFR5N-11T | 7742 | |
| Golf 5 FSI | 2.0 | 110 | 05.04-07.07 | BLX | 4 | | PZFR5N-11T | 7742 | | PZFR5N-11T | 7742 | |
| Golf 5 FSI | 2.0 | 110 | 05.04-07.07 | BLY | 4 | 0,9 | BKR6E | 6962 | 28 | LPG 1 | 1496 | |
| Golf 5 FSI | 2.0 | 110 | 11.05-11.08 | BVX | 4 | | PZFR5N-11T | 7742 | | PZFR5N-11T | 7742 | |
| Golf 5 FSI | 2.0 | 110 | 05.05-11.08 | BVY | 4 | | PZFR5N-11T | 7742 | | PZFR5N-11T | 7742 | |
| Golf 5 FSI | 2.0 | 110 | 11.05-11.08 | BVZ | 4 | 0,9 | BKR6E | 6962 | 28 | LPG 1 | 1496 | |
| Golf 5 FSI turbo | 2.0 | 147 | 09.04-01.06 | AXX | 4 | 0,8 | PFR7S8EG | 1675 | | | | |
| Golf 5 GT TSI | 1.4 | 125 | 11.05- | BLG | 4 | 0,9 | PZFR6R | 5758 | | PZFR6R | 5758 | |
| Golf 5 GTI | 2.0 | 147 | 11.05- | BWA | 4 | 0,8 | PFR7S8EG | 1675 | | | | |
| Golf 5 GTI | 2.0 | 147 | 03.08- | CAWB | 4 | 0,8 | PFR7S8EG | 1675 | | | | |
| Golf 5 GTI | 2.0 | 169 | 09.06-11.08 | BYD | 4 | 0,8 | PFR7S8EG | 1675 | | | | |
| Golf 5 R32 | 3.2 | 184 | 05.05-11.08 | BUB | 6 | 0,9 | IZKR7B | 7563 | | IZKR7B | 7563 | |
| Golf 5 SDI | 2.0 | 55 | 01.04-05.07 | BDK | 4 | ■ | Y-607AS | 7560 | | D-POWER 50 | 7560 | |
| Golf 5 TDI | 1.6 | 66 | 12.08- | CAYB | 4 | ■ | Y1002AS | 8888 | | D-POWER 57 | 8888 | |
| Golf 5 TDI | 1.9 | 66 | 05.04-02.06 | BRU | 4 | ■ | Y-607AS | 7560 | | D-POWER 50 | 7560 | |
| Golf 5 TDI | 1.9 | 66 | 02.06-01.09 | BXF | 4 | ■ | Y-607AS | 7560 | | D-POWER 50 | 7560 | |
| Golf 5 TDI | 1.9 | 66 | 05.07-01.09 | BXJ | 4 | ■ | Y-607AS | 7560 | | D-POWER 50 | 7560 | |
| Golf 5 TDI | 1.9 | 77 | 02.06- | BXE | 4 | ■ | Y-607AS | 7560 | | D-POWER 50 | 7560 | |
| Golf 5 TDI | 2.0 | 81 | 10.08- | CBDC | 4 | ■ | Y1002AS | 8888 | | D-POWER 57 | 8888 | |
| Golf 5 TDI | 2.0 | 100 | 10.08-11.09 | CBAA | 4 | ■ | Y1002AS | 8888 | | D-POWER 57 | 8888 | |
| Golf 5 TDI | 2.0 | 103 | 10.03-05.07 | BKD | 4 | ■ | YE14 | 7768 | | D-POWER 48 | 7768 | |
| Golf 5 TDI | 2.0 | 103 | 12.04- | BMM | 4 | ■ | Y-607AS | 7560 | | D-POWER 50 | 7560 | |
| Golf 5 TDI | 2.0 | 125 | 11.05-11.08 | BMN | 4 | ■ | CZ304 | 9864 | | D-POWER 55 | 9864 | |
| Golf 5 TDI only with DPF | 1.9 | 77 | 06.05-05.07 | BLS | 4 | ■ | CZ104 | 9826 | | D-POWER 52 | 9826 | |
| Golf 5 TDI without DPF | 1.9 | 77 | 06.05-05.07 | BLS | 4 | ■ | Y-607AS | 7560 | | D-POWER 50 | 7560 | |
| Golf 5 TSI | 1.4 | 90 | 07.07- | CAXA | 4 | 0,9 | PZFR6R | 5758 | | PZFR6R | 5758 | |
| Golf 5 TSI | 1.4 | 103 | 05.06-05.07 | BMY | 4 | 0,9 | PZFR6R | 5758 | | PZFR6R | 5758 | |
| Golf 5 TSI | 1.4 | 118 | 07.08- | CAVD | 4 | 0,9 | PZFR6R | 5758 | | PZFR6R | 5758 | |
| Golf 6 | 1.4 | 59 | 01.09- | CGGA | 4 | 1,1 | ZFR6T-11G | 5960 | | ZFR6T-11G | 5960 | |
| Golf 6 | 1.6 | 75 | 11.08- | CCSA | 4 | | BKUR6ET-10 | 2397 | 24 | LPG 1 | 1496 | |



ℓ kW



Cyl.

Order-
No. No.LPG/CNG
D-PowerOrder-
No.**VW**

| | | | | | | | | | | | |
|-----------------------|-----|-----|---------------|------|---|-----|------------|------|----|------------|------|
| Golf 6 | 1.6 | 75 | 05.10 - | CMXA | 4 | | BKUR6ET-10 | 2397 | 24 | LPG 1 | 1496 |
| Golf 6 LPG | 1.6 | 75 | 03.09 - | CHGA | 4 | | BKUR6ET-10 | 2397 | 24 | LPG 1 | 1496 |
| Golf 6 Plus TDI | 1.6 | 66 | 05.09 - | CAYB | 4 | █ | Y1002AS | 8888 | | D-POWER 57 | 8888 |
| Golf 6 Plus TDI | 1.6 | 77 | 02.09 - | CAYC | 4 | █ | Y1002AS | 8888 | | D-POWER 57 | 8888 |
| Golf 6 Plus TDI | 2.0 | 100 | 01.09 - | CBDA | 4 | █ | Y1002AS | 8888 | | D-POWER 57 | 8888 |
| Golf 6 Plus TDI | 2.0 | 100 | 01.09 - | CFHB | 4 | █ | Y1002AS | 8888 | | D-POWER 57 | 8888 |
| Golf 6 Plus TDI | 2.0 | 103 | 10.08 - | CBDB | 4 | █ | Y1002AS | 8888 | | D-POWER 57 | 8888 |
| Golf 6 Plus TDI | 2.0 | 103 | 10.08 - | CFHC | 4 | █ | Y1002AS | 8888 | | D-POWER 57 | 8888 |
| Golf 6 Plus TDI | 2.0 | 81 | 03.09 - | CBDC | 4 | █ | Y1002AS | 8888 | | D-POWER 57 | 8888 |
| Golf 6 TDI | 1.6 | 77 | 01.09 - | CAYC | 4 | █ | Y1002AS | 8888 | | D-POWER 57 | 8888 |
| Golf 6 TDI | 1.6 | 66 | 12.08 - | CAYB | 4 | █ | Y1002AS | 8888 | | D-POWER 57 | 8888 |
| Golf 6 TDI | 1.6 | 77 | 02.09 - | CAYC | 4 | █ | Y1002AS | 8888 | | D-POWER 57 | 8888 |
| Golf 6 TDI | 2.0 | 100 | 11.09 - | CFFA | 4 | █ | Y1002AS | 8888 | | D-POWER 57 | 8888 |
| Golf 6 TDI | 2.0 | 100 | 11.09 - | CFHB | 4 | █ | Y1002AS | 8888 | | D-POWER 57 | 8888 |
| Golf 6 TDI | 2.0 | 103 | 10.08 - | CBAB | 4 | █ | Y-609AS | 5849 | | D-POWER 49 | 5849 |
| Golf 6 TDI | 2.0 | 103 | 11.09 - | CFHC | 4 | █ | Y1002AS | 8888 | | D-POWER 57 | 8888 |
| Golf 6 TDI | 2.0 | 100 | 10.08 - | CBAA | 4 | █ | Y1002AS | 8888 | | D-POWER 57 | 8888 |
| Golf 6 TDI | 2.0 | 100 | 10.08 - | CFFA | 4 | █ | Y1002AS | 8888 | | D-POWER 57 | 8888 |
| Golf 6 TDI | 2.0 | 103 | 10.08 - | CFFB | 4 | █ | Y1002AS | 8888 | | D-POWER 57 | 8888 |
| Golf 6 TDI | 2.0 | 103 | 10.08 - | CJAA | 4 | █ | Y1002AS | 8888 | | D-POWER 57 | 8888 |
| Golf 6 TDI | 2.0 | 81 | 10.08 - | CBDC | 4 | █ | Y1002AS | 8888 | | D-POWER 57 | 8888 |
| Golf 6 TSI | 1.4 | 90 | 05.08 - | CAXA | 4 | 0,9 | PZFR6R | 5758 | | PZFR6R | 5758 |
| Golf 6 TSI | 1.8 | 118 | 06.09 - | CDAA | 4 | 0,8 | PFR7S8EG | 1675 | | | |
| Golf 6 TSI | 2.0 | 199 | 11.09 - | CDLF | 4 | 0,8 | PFR7S8EG | 1675 | | | |
| Jetta | 1.4 | 90 | 07.07 - | CAXA | 4 | 0,9 | PZFR6R | 5758 | | PZFR6R | 5758 |
| Jetta | 1.4 | 118 | 07.08 - | CAVD | 4 | 0,9 | PZFR6R | 5758 | | PZFR6R | 5758 |
| Jetta | 1.6 | 75 | 08.05 - | BSE | 4 | | BKUR6ET-10 | 2397 | 24 | LPG 1 | 1496 |
| Jetta | 1.6 | 75 | 10.05 - | BSF | 4 | | BKUR6ET-10 | 2397 | 24 | LPG 1 | 1496 |
| Jetta | 2.0 | 136 | 09.05 - | BWA | 4 | 0,8 | PFR7S8EG | 1675 | | | |
| Jetta | 2.5 | 125 | 07.07 - | CCCA | 5 | 1,1 | ZFR6T-11G | 5960 | | ZFR6T-11G | 5960 |
| Jetta FSI | 1.6 | 85 | 09.05 - 06.08 | BLF | 4 | | ZFR6S-Q | 6449 | | ZFR6S-Q | 6449 |
| Jetta FSI | 2.0 | 110 | 08.05 - 11.05 | BLR | 4 | | PZFR5N-11T | 7742 | | PZFR5N-11T | 7742 |
| Jetta FSI | 2.0 | 110 | 10.05 - 11.05 | BLY | 4 | 0,9 | BKR6E | 6962 | 28 | LPG 1 | 1496 |
| Jetta FSI | 2.0 | 110 | 12.05 - 06.08 | BVY | 4 | | PZFR5N-11T | 7742 | | PZFR5N-11T | 7742 |
| Jetta FSI | 2.0 | 110 | 12.05 - 06.08 | BVZ | 4 | 0,9 | BKR6E | 6962 | 28 | LPG 1 | 1496 |
| Jetta TDI | 1.9 | 74 | 01.05 - | BRM | 4 | █ | CZ104 | 9826 | | D-POWER 52 | 9826 |
| Jetta TDI | 1.9 | 77 | 08.05 - 02.06 | BKC | 4 | █ | Y-607AS | 7560 | | D-POWER 50 | 7560 |
| Jetta TDI | 1.9 | 77 | 08.05 - | BLS | 4 | █ | CZ104 | 9826 | | D-POWER 52 | 9826 |
| Jetta TDI | 1.9 | 77 | 09.05 - | BXE | 4 | █ | Y-607AS | 7560 | | D-POWER 50 | 7560 |
| Jetta TDI | 2.0 | 100 | 09.05 - | AZV | 4 | █ | YE14 | 7768 | | D-POWER 48 | 7768 |
| Jetta TDI | 2.0 | 103 | 08.05 - 06.08 | BKD | 4 | █ | YE14 | 7768 | | D-POWER 48 | 7768 |
| Jetta TDI | 2.0 | 103 | 10.05 - 06.08 | BMM | 4 | █ | Y-607AS | 7560 | | D-POWER 50 | 7560 |
| Jetta TDI | 2.0 | 125 | 06.06 - 06.08 | BMN | 4 | █ | CZ304 | 9864 | | D-POWER 55 | 9864 |
| Jetta TSI | 1.4 | 103 | 07.06 - 06.08 | BMY | 4 | 0,9 | PZFR6R | 5758 | | PZFR6R | 5758 |
| Jetta TSI | 1.4 | 125 | 07.06 - 06.08 | BLG | 4 | 0,9 | PZFR6R | 5758 | | PZFR6R | 5758 |
| Käfer (MEXICO IMPORT) | 1.6 | 34 | 01.93 - | ACD | 4 | 0,8 | BP5ESA | 2285 | | | |
| LT | 2.3 | 105 | 05.96 - 11.01 | AGL | 4 | | BKUR5ET | 2789 | 29 | LPG 1 | 1496 |
| LT | 2.4 | 51 | 08.89 - 03.96 | | 5 | █ | Y-918J | 6285 | | D-POWER 2 | 6285 |
| LT | 2.4 | 51 | 08.92 - 12.95 | ACT | 6 | █ | Y-918J | 6285 | | D-POWER 2 | 6285 |
| LT | 2.4 | 62 | 12.82 - 07.86 | HS | 4 | 0,7 | BP6ES | 7811 | 4 | LPG 2 | 1497 |
| LT | 2.4 | 66 | 08.82 - 07.92 | DL | 6 | 0,7 | BP6ESZ | 7639 | | LPG 2 | 1497 |
| LT | 2.4 | 70 | 08.88 - 12.95 | 1E | 6 | 0,7 | BP6ESZ | 7639 | | LPG 2 | 1497 |



ℓ kW

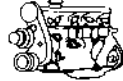

Cyl.

Order-
No.VLINE
No.LPG/CNG
D-PowerOrder-
No.**VW**

| | | | | | | | | | | | |
|-----------------------------|-----|-----|--------------|-----|---|-----|------------|------|----|------------|------|
| LT | 2.5 | 65 | 04.06 - | BJJ | 5 | █ | CZ104 | 9826 | | D-POWER 52 | 9826 |
| LT TD | 2.4 | 55 | 12.82 -07.92 | DW | 6 | █ | Y-918J | 6285 | | D-POWER 2 | 6285 |
| LT TD | 2.4 | 68 | 12.82 -03.96 | | 5 | █ | Y-918J | 6285 | | D-POWER 2 | 6285 |
| LT Td | 2.4 | 68 | 08.88 -07.91 | 1G | 6 | █ | Y-918J | 6285 | | D-POWER 2 | 6285 |
| LT TD | 2.4 | 70 | 08.91 -12.95 | ACL | 6 | █ | Y-918J | 6285 | | D-POWER 2 | 6285 |
| LT TD | 2.4 | 75 | 12.82 -07.92 | DV | 6 | █ | Y-918J | 6285 | | D-POWER 2 | 6285 |
| LT TD 4X4 | 2.4 | 55 | 09.85 -03.96 | | 5 | █ | Y-918J | 6285 | | D-POWER 2 | 6285 |
| LT TDI | 2.5 | 61 | 04.01 -07.06 | BBE | 5 | █ | Y-732J | 5605 | | D-POWER 4 | 5605 |
| LT TDI | 2.5 | 66 | 05.99 -04.01 | APA | 5 | █ | Y-732J | 5605 | | D-POWER 4 | 5605 |
| LT TDI | 2.5 | 70 | 04.01 -07.06 | BBF | 5 | █ | Y-732J | 5605 | | D-POWER 4 | 5605 |
| LT TDI | 2.5 | 75 | 05.96 -05.99 | AHD | 5 | █ | Y-732J | 5605 | | D-POWER 4 | 5605 |
| LT TDI | 2.5 | 80 | 05.99 -07.06 | ANJ | 5 | █ | Y-732J | 5605 | | D-POWER 4 | 5605 |
| LT TDI | 2.5 | 80 | 12.02 -07.06 | AVR | 5 | █ | Y-732J | 5605 | | D-POWER 4 | 5605 |
| LT 28 D | 2.4 | 51 | 08.88 -12.95 | 1S | 6 | █ | Y-918J | 6285 | | D-POWER 2 | 6285 |
| LT 28 D TD | 2.4 | 68 | 12.82 - | | 6 | █ | Y-918J | 6285 | | D-POWER 2 | 6285 |
| LT 28 SDI | 2.5 | 55 | 05.96 - | | 5 | █ | Y-732J | 5605 | | D-POWER 4 | 5605 |
| LT 28 TDi | 2.8 | 92 | 05.96 - | | 6 | █ | Y-732J | 5605 | | D-POWER 4 | 5605 |
| LT 31 D | 2.4 | 51 | 08.88 -12.95 | 1S | 6 | █ | Y-918J | 6285 | | D-POWER 2 | 6285 |
| LT 31 D TD | 2.4 | 68 | 12.82 - | | 6 | █ | Y-918J | 6285 | | D-POWER 2 | 6285 |
| LT 35 SDI | 2.5 | 55 | 05.96 -04.01 | AGX | 5 | █ | Y-732J | 5605 | | D-POWER 4 | 5605 |
| LT 35 TDi | 2.8 | 92 | 05.96 - | | 5 | █ | Y-732J | 5605 | | D-POWER 4 | 5605 |
| LT 40 D | 2.4 | 51 | 08.88 -12.95 | 1S | 6 | █ | Y-918J | 6285 | | D-POWER 2 | 6285 |
| LT 40 D / TD 4X4 | 2.4 | 55 | 09.85 - | | 4 | █ | Y-918J | 6285 | | D-POWER 2 | 6285 |
| LT 40 D TD | 2.4 | 68 | 12.82 - | | 4 | █ | Y-918J | 6285 | | D-POWER 2 | 6285 |
| LT 45 D / TD | 2.4 | 55 | 09.85 - | | 4 | █ | Y-918J | 6285 | | D-POWER 2 | 6285 |
| LT TDI | 2.5 | 80 | 04.06 - | BJK | 5 | █ | CZ104 | 9826 | | D-POWER 52 | 9826 |
| LT TDI | 2.5 | 100 | 04.06 - | BJL | 5 | █ | CZ104 | 9826 | | D-POWER 52 | 9826 |
| LT TDI | 2.5 | 120 | 04.06 - | BJM | 5 | █ | CZ104 | 9826 | | D-POWER 52 | 9826 |
| Lupo | 1.0 | 37 | 01.99 -05.00 | AER | 4 | | BUR6ET | 3172 | 1 | LPG 2 | 1497 |
| Lupo | 1.0 | 37 | 10.98 -05.00 | AHT | 4 | | BKR6ETA-10 | 7998 | | | |
| Lupo | 1.0 | 37 | 05.99 -07.05 | ALD | 4 | 0,9 | ZFR5P-G | 6893 | | LPG 6 | 1565 |
| Lupo | 1.0 | 37 | 10.98 -05.00 | ALL | 4 | | BUR6ET | 3172 | 1 | LPG 2 | 1497 |
| Lupo | 1.0 | 37 | 05.99 -05.00 | ANV | 4 | 0,9 | ZFR5P-G | 6893 | | LPG 6 | 1565 |
| Lupo | 1.0 | 37 | 05.00 -07.05 | AUC | 4 | 0,9 | ZFR5P-G | 6893 | | LPG 6 | 1565 |
| Lupo | 1.4 | 44 | 09.00 -07.05 | AUD | 4 | 0,9 | ZFR5P-G | 6893 | | LPG 6 | 1565 |
| Lupo | 1.4 | 55 | 01.99 -07.05 | AHW | 4 | | BKUR6ET-10 | 2397 | 24 | LPG 1 | 1496 |
| Lupo | 1.4 | 55 | 07.98 -05.99 | AKQ | 4 | | BKUR6ET-10 | 2397 | 24 | LPG 1 | 1496 |
| Lupo | 1.4 | 55 | 05.99 -09.00 | APE | 4 | | BKUR6ET-10 | 2397 | 24 | LPG 1 | 1496 |
| Lupo | 1.4 | 55 | 05.00 -04.02 | AUA | 4 | | BKUR6ET-10 | 2397 | 24 | LPG 1 | 1496 |
| Lupo | 1.4 | 55 | 04.02 -07.05 | BBY | 4 | | BKUR6ET-10 | 2397 | 24 | LPG 1 | 1496 |
| Lupo | 1.4 | 74 | 05.99 -10.00 | AFK | 4 | | BKUR6ET-10 | 2397 | 24 | LPG 1 | 1496 |
| Lupo | 1.4 | 74 | 05.99 -05.00 | ANM | 4 | | BKUR6ET-10 | 2397 | 24 | LPG 1 | 1496 |
| Lupo | 1.4 | 74 | 05.99 -05.00 | AQQ | 4 | | BKUR6ET-10 | 2397 | 24 | LPG 1 | 1496 |
| Lupo | 1.4 | 74 | 05.00 -07.05 | AUB | 4 | | BKUR6ET-10 | 2397 | 24 | LPG 1 | 1496 |
| Lupo FSI | 1.4 | 77 | 09.00 -11.03 | ARR | 4 | | ZFR6S-Q | 6449 | | ZFR6S-Q | 6449 |
| Lupo GTI | 1.6 | 92 | 06.00 -07.05 | AVY | 4 | | BKUR6ET-10 | 2397 | 24 | LPG 1 | 1496 |
| Lupo SDI | 1.7 | 42 | 10.98 -07.05 | AKU | 4 | █ | Y-732J | 5605 | | D-POWER 4 | 5605 |
| Lupo TDI | 1.2 | 45 | 06.99 -11.00 | ANY | 3 | █ | Y-732J | 5605 | | D-POWER 4 | 5605 |
| Lupo TDI >6x-2-005 000 | 1.2 | 45 | 11.00 -07.05 | AYZ | 3 | █ | Y-732J | 5605 | | D-POWER 4 | 5605 |
| Lupo TDI 6x-2-005 001> | 1.2 | 45 | 11.00 -07.05 | AYZ | 3 | █ | Y-741U | 6943 | | D-POWER 20 | 6943 |
| Lupo TDI Fgst >6x-2-005 000 | 1.4 | 55 | 05.99 -07.05 | AMF | 3 | █ | Y-732J | 5605 | | D-POWER 4 | 5605 |
| Lupo TDI Fgst 6x-2-005 001> | 1.4 | 55 | 05.99 -07.05 | AMF | 3 | █ | Y-741U | 6943 | | D-POWER 20 | 6943 |

Fgst = Chassis No.



ℓ kW



Cyl.

Order-
No. No.LPG/CNG
D-PowerOrder-
No.**VW**

| | | | | | | | | | | | |
|----------------------------|-----|-----|---------------|-----|---|-----|------------|------|----|-----------|------|
| Passat 1 (Typ 32/33) | 1.6 | 40 | 08.81 - 03.88 | JK | 4 | ■ | Y-918J | 6285 | | D-POWER 2 | 6285 |
| Passat 1 (Typ 32/33) D | 1.6 | 40 | 08.80 - 07.82 | CR | 4 | ■ | Y-918J | 6285 | | D-POWER 2 | 6285 |
| Passat 2 (Typ 32B) | 1.3 | 44 | 08.83 - 07.84 | EP | 4 | | BUR5ET-10 | 7264 | 21 | LPG 2 | 1497 |
| Passat 2 (Typ 32B) | 1.6 | 51 | 08.86 - 03.88 | DTA | 4 | | BUR5ET-10 | 7264 | 21 | LPG 2 | 1497 |
| Passat 2 (Typ 32B) | 1.6 | 51 | 08.83 - 03.88 | PP | 4 | | BUR5ET-10 | 7264 | 21 | LPG 2 | 1497 |
| Passat 2 (Typ 32B) | 1.6 | 53 | 08.83 - 03.88 | RL | 4 | | BUR5ET-10 | 7264 | 21 | LPG 2 | 1497 |
| Passat 2 (Typ 32B) | 1.6 | 55 | 08.83 - 03.88 | DT | 4 | | BUR5ET-10 | 7264 | 21 | LPG 2 | 1497 |
| Passat 2 (Typ 32B) | 1.6 | 55 | 08.83 - 07.86 | JU | 4 | | BUR5ET-10 | 7264 | 21 | LPG 2 | 1497 |
| Passat 2 (Typ 32B) | 1.8 | 64 | 09.82 - 03.88 | RM | 4 | | BUR6ET | 3172 | 1 | LPG 2 | 1497 |
| Passat 2 (Typ 32B) | 1.8 | 66 | 01.83 - 07.88 | DS | 4 | | BUR6ET | 3172 | 1 | LPG 2 | 1497 |
| Passat 2 (Typ 32B) | 1.8 | 66 | 08.83 - 07.88 | JN | 4 | | BUR6ET | 3172 | 1 | LPG 2 | 1497 |
| Passat 2 (Typ 32B) | 1.8 | 79 | 01.83 - 07.90 | PF | 4 | | BUR6ET | 3172 | 1 | LPG 2 | 1497 |
| Passat 2 (Typ 32B) | 1.8 | 82 | 12.83 - 07.84 | DZ | 4 | | BUR6ET | 3172 | 1 | LPG 2 | 1497 |
| Passat 2 (Typ 32B) | 1.8 | 82 | 01.83 - 07.90 | PB | 4 | | BUR6ET | 3172 | 1 | LPG 2 | 1497 |
| Passat 2 (Typ 32B) | 1.9 | 85 | 01.81 - 07.83 | WN | 4 | 0,8 | BP7ES | 2412 | | BPR8EIX | 6684 |
| Passat 2 (Typ 32B) | 2.0 | 85 | 08.83 - 07.88 | HP | 4 | | BUR6ET | 3172 | 1 | LPG 2 | 1497 |
| Passat 2 (Typ 32B) | 2.0 | 85 | 08.83 - 03.88 | JS | 5 | | BUR6ET | 3172 | 1 | LPG 2 | 1497 |
| Passat 2 (Typ 32B) | 2.2 | 85 | 08.85 - 03.88 | KX | 5 | | BUR6ET | 3172 | 1 | LPG 2 | 1497 |
| Passat 2 (Typ 32B) | 2.2 | 88 | 08.85 - 07.88 | JT | 5 | | BUR6ET | 3172 | 1 | LPG 2 | 1497 |
| Passat 2 (Typ 32B) | 2.2 | 100 | 08.84 - 07.88 | HY | 5 | | BUR6ET | 3172 | 1 | LPG 2 | 1497 |
| Passat 2 (Typ 32B) | 2.2 | 100 | 01.85 - 03.88 | KV | 5 | | BUR6ET | 3172 | 1 | LPG 2 | 1497 |
| Passat 2 (Typ 32B) (China) | 1.8 | 66 | 09.82 - 04.88 | JV | 4 | | BUR6ET | 3172 | 1 | LPG 2 | 1497 |
| Passat 2 (Typ 32B) TD | 1.6 | 51 | 12.81 - 03.88 | CY | 4 | ■ | Y-918J | 6285 | | D-POWER 2 | 6285 |
| Passat 3 (Typ 35i) | 1.6 | 53 | 04.88 - 07.91 | RF | 4 | | BUR5ET-10 | 7264 | 21 | LPG 2 | 1497 |
| Passat 3 (Typ 35i) | 1.6 | 55 | 08.88 - 07.89 | 1F | 4 | | BUR5ET | 3377 | 22 | LPG 2 | 1497 |
| Passat 3 (Typ 35i) | 1.6 | 55 | 08.89 - 07.92 | ABN | 4 | | BUR5ET-10 | 7264 | 21 | LPG 2 | 1497 |
| Passat 3 (Typ 35i) | 1.6 | 55 | 04.88 - 07.89 | EZ | 4 | | BUR6ET | 3172 | 1 | LPG 2 | 1497 |
| Passat 3 (Typ 35i) | 1.6 | 55 | 08.89 - 09.91 | EZ | 4 | | BUR5ET-10 | 7264 | 21 | LPG 2 | 1497 |
| Passat 3 (Typ 35i) | 1.6 | 74 | 10.94 - 12.95 | AEK | 4 | | BKUR5ET | 2789 | 29 | LPG 1 | 1496 |
| Passat 3 (Typ 35i) | 1.6 | 74 | 12.95 - 12.96 | AFT | 4 | | BKUR6ET-10 | 2397 | 24 | LPG 1 | 1496 |
| Passat 3 (Typ 35i) | 1.8 | 55 | 08.90 - 12.96 | AAM | 4 | | BUR5ET | 3377 | 22 | LPG 2 | 1497 |
| Passat 3 (Typ 35i) | 1.8 | 66 | 08.91 - 09.94 | ABS | 4 | | BUR6ET | 3172 | 1 | LPG 2 | 1497 |
| Passat 3 (Typ 35i) | 1.8 | 66 | 08.94 - 12.96 | ADZ | 4 | | BUR6ET | 3172 | 1 | LPG 2 | 1497 |
| Passat 3 (Typ 35i) | 1.8 | 66 | 04.88 - 07.91 | RP | 4 | | BUR6ET | 3172 | 1 | LPG 2 | 1497 |
| Passat 3 (Typ 35i) | 1.8 | 100 | 04.88 - 07.92 | KR | 4 | | BCPR7ET | 2164 | | BCPR7EIX | 5690 |
| Passat 3 (Typ 35i) | 2.0 | 85 | 03.90 - 09.94 | 2E | 4 | | BUR6ET | 3172 | 1 | LPG 2 | 1497 |
| Passat 3 (Typ 35i) | 2.0 | 85 | 06.93 - 12.94 | ACX | 4 | | BUR6ET | 3172 | 1 | LPG 2 | 1497 |
| Passat 3 (Typ 35i) | 2.0 | 85 | 10.94 - 12.95 | ADY | 4 | | BUR6ET | 3172 | 1 | LPG 2 | 1497 |
| Passat 3 (Typ 35i) | 2.0 | 85 | 07.96 - 12.96 | AGG | 4 | | BUR6ET | 3172 | 1 | LPG 2 | 1497 |
| Passat 3 (Typ 35i) | 2.0 | 100 | 04.88 - 10.93 | 9A | 4 | | BKUR7ET | 7873 | | PFR7Q | 7963 |
| Passat 3 (Typ 35i) | 2.0 | 110 | 07.94 - 12.96 | ABF | 4 | | BKUR6ET-10 | 2397 | 24 | LPG 1 | 1496 |
| Passat 3 (Typ 35i) | 2.8 | 128 | 06.91 - 06.95 | AAA | 6 | | BKR5EKU | 3964 | | | |
| Passat 3 (Typ 35i) | 2.8 | 128 | 07.95 - 12.96 | AAA | 6 | | BKR5EKUP | 2890 | | | |
| Passat 3 (Typ 35i) | 2.9 | 135 | 07.94 - 06.95 | ABV | 6 | | BKR5EKU | 3964 | | | |
| Passat 3 (Typ 35i) | 2.9 | 135 | 07.95 - 12.96 | ABV | 6 | | BKR5EKUP | 2890 | | | |
| Passat 3 (Typ 35i) China | 1.6 | 65 | | AYE | 4 | | BP5ES | 6511 | 8 | LPG 2 | 1497 |
| Passat 3 (Typ 35i) China | 1.8 | 71 | | AYJ | 4 | | BKR5E | 7938 | 35 | LPG 1 | 1496 |
| Passat 3 (Typ 35i) China | 2.0 | 79 | 03.95 - 12.96 | AEP | 4 | | BUR6ET | 3172 | 1 | LPG 2 | 1497 |
| Passat 3 (Typ 35i) (GUS) | 1.8 | 85 | 01.97 - 04.00 | AFY | 4 | | BKUR6ET-10 | 2397 | 24 | LPG 1 | 1496 |
| Passat 3 (Typ 35i) (US) | 2.8 | 142 | 10.94 - 12.95 | AHA | 6 | | BKR6EKUB | 3584 | | LPG 1 | 1496 |
| Passat 3 (Typ 35i) G60 | 1.8 | 118 | 10.88 - 04.93 | PG | 4 | | only OES | | | | |
| Passat 3 (Typ 35i) D,TD | 1.9 | 47 | 05.89 - 10.93 | 1Y | 4 | ■ | Y-918J | 6285 | | D-POWER 2 | 6285 |



ℓ kW

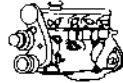

Cyl.

Order-
No.VLINE
No.LPG/CNG
D-PowerOrder-
No.**VW**

| | | | | | | | | | | | |
|------------------------------|-----|-----|---------------|-----|---|-----|------------|------|----|------------|------|
| Passat 3 (Typ 35i) TD | 1.6 | 59 | 08.89 - 10.93 | SB | 4 | █ | Y-918J | 6285 | | D-POWER 2 | 6285 |
| Passat 3 (Typ 35i) TD | 1.9 | 55 | 03.91 - 12.96 | AAZ | 4 | █ | Y-918J | 6285 | | D-POWER 2 | 6285 |
| Passat 3 (Typ 35i) TDI | 1.9 | 66 | 08.89 - 12.96 | 1Z | 4 | █ | Y-732J | 5605 | | D-POWER 4 | 5605 |
| Passat 3 (Typ 35i) TDI | 1.9 | 66 | 08.96 - 08.00 | AHU | 4 | █ | Y-732J | 5605 | | D-POWER 4 | 5605 |
| Passat 3 (Typ 35i) TDI | 1.9 | 81 | 03.96 - 08.99 | AFN | 4 | █ | Y-732J | 5605 | | D-POWER 4 | 5605 |
| Passat 4 W8 4MOTION | 4.0 | 202 | 05.02 - 09.04 | BDP | 8 | | BKR6EKUE | 7892 | | | |
| Passat 4 W8 4MOTION | 4.0 | 202 | 09.01 - 09.04 | BDN | 8 | | BKR6EKUE | 7892 | | | |
| Passat 4 (Typ 3B) | 1.6 | 74 | 01.97 - 10.97 | ADP | 4 | | BKUR6ET-10 | 2397 | 24 | LPG 1 | 1496 |
| Passat 4 (Typ 3B) | 1.6 | 74 | 10.96 - 08.00 | AHL | 4 | | BKUR6ET-10 | 2397 | 24 | LPG 1 | 1496 |
| Passat 4 (Typ 3B) | 1.6 | 74 | 07.99 - 08.00 | ANA | 4 | | BKUR6ET-10 | 2397 | 24 | LPG 1 | 1496 |
| Passat 4 (Typ 3B) | 1.6 | 74 | 01.99 - 08.00 | ARM | 4 | | BKUR6ET-10 | 2397 | 24 | LPG 1 | 1496 |
| Passat 4 (Typ 3B) | 1.6 | 75 | 10.00 - 05.05 | ALZ | 4 | | BKUR6ET-10 | 2397 | 24 | LPG 1 | 1496 |
| Passat 4 (Typ 3B) | 1.8 | 92 | 12.96 - 01.99 | ADR | 4 | | BKUR6ET-10 | 2397 | 24 | LPG 1 | 1496 |
| Passat 4 (Typ 3B) | 1.8 | 92 | 01.99 - 08.00 | APT | 4 | | BKUR6ET-10 | 2397 | 24 | LPG 1 | 1496 |
| Passat 4 (Typ 3B) | 1.8 | 92 | 02.99 - 08.00 | ARG | 4 | | BKUR6ET-10 | 2397 | 24 | LPG 1 | 1496 |
| Passat 4 (Typ 3B) | 1.8 | 110 | 10.96 - 12.98 | AEB | 4 | 0,8 | PFR6Q | 6458 | 37 | LPG 1 | 1496 |
| Passat 4 (Typ 3B) | 1.8 | 110 | 01.99 - 08.00 | ANB | 4 | 0,8 | PFR6Q | 6458 | 37 | LPG 1 | 1496 |
| Passat 4 (Typ 3B) | 1.8 | 110 | 01.99 - 08.00 | APU | 4 | 0,8 | PFR6Q | 6458 | 37 | LPG 1 | 1496 |
| Passat 4 (Typ 3B) | 1.8 | 110 | 10.00 - 05.05 | AWT | 4 | 0,8 | PFR6Q | 6458 | 37 | LPG 1 | 1496 |
| Passat 4 (Typ 3B) | 2.0 | 85 | 10.00 - 05.05 | AZM | 4 | | BKUR6ET-10 | 2397 | 24 | LPG 1 | 1496 |
| Passat 4 (Typ 3B) | 2.0 | 96 | 11.01 - 05.05 | ALT | 4 | | BKUR5ET-10 | 7553 | | LPG 1 | 1496 |
| Passat 4 (Typ 3B) | 2.3 | 110 | 09.97 - 08.00 | AGZ | 5 | | BKR5EKUP | 2890 | | | |
| Passat 4 (Typ 3B) | 2.3 | 125 | 01.01 - 05.05 | AZX | 5 | 1,1 | PZFR5D-11 | 7968 | 34 | LPG 6 | 1565 |
| Passat 4 (Typ 3B) | 2.8 | 140 | 09.99 - 08.00 | ATX | 6 | | BKR6EKUB | 3584 | | LPG 1 | 1496 |
| Passat 4 (Typ 3B) | 2.8 | 142 | 06.97 - 12.98 | ACK | 6 | | BKR6EKUB | 3584 | | LPG 1 | 1496 |
| Passat 4 (Typ 3B) | 2.8 | 142 | 08.97 - 12.98 | ALG | 6 | | BKR6EKUB | 3584 | | LPG 1 | 1496 |
| Passat 4 (Typ 3B) | 2.8 | 142 | 10.00 - 05.05 | AMX | 6 | | BKR6EKUB | 3584 | | LPG 1 | 1496 |
| Passat 4 (Typ 3B) | 2.8 | 142 | 01.99 - 08.00 | APR | 6 | | BKR6EKUB | 3584 | | LPG 1 | 1496 |
| Passat 4 (Typ 3B) | 2.8 | 142 | 01.99 - 08.00 | AQD | 6 | | BKR6EKUB | 3584 | | LPG 1 | 1496 |
| Passat 4 (Typ 3B) | 2.8 | 142 | 10.00 - 05.05 | ATQ | 6 | | BKR6EKUB | 3584 | | LPG 1 | 1496 |
| Passat 4 (Typ 3B) China | 1.8 | 71 | | AJR | 4 | | BKR5E | 7938 | 35 | LPG 1 | 1496 |
| Passat 4 (Typ 3B) China | 1.8 | 92 | | ANQ | 4 | | BKUR6ET-10 | 2397 | 24 | LPG 1 | 1496 |
| Passat 4 (Typ 3B) China | 1.8 | 110 | | AWL | 4 | | PFR6Q | 6458 | 37 | LPG 1 | 1496 |
| Passat 4 (Typ 3B) China | 1.8 | 110 | 12.05 - | BGC | 4 | | PFR6Q | 6458 | 37 | LPG 1 | 1496 |
| Passat 4 (Typ 3B) China | 2.0 | 85 | 12.05 - | BFF | 4 | | PFR6Q | 6458 | 37 | LPG 1 | 1496 |
| Passat 4 (Typ 3B) China | 2.8 | 140 | 10.00 - 05.05 | BBG | 6 | | BKR6EKUB | 3584 | | LPG 1 | 1496 |
| Passat 4 (Typ 3B) China, GUS | 2.8 | 132 | 09.97 - 09.99 | AGE | 6 | | BKR6EKUB | 3584 | | LPG 1 | 1496 |
| Passat 4 (Typ 3B) TDI | 1.9 | 66 | 05.98 - 08.00 | AHH | 4 | █ | Y-732J | 5605 | | D-POWER 4 | 5605 |
| Passat 4 (Typ 3B) TDI | 1.9 | 81 | 08.99 - 08.00 | AVG | 4 | █ | Y-732J | 5605 | | D-POWER 4 | 5605 |
| Passat 4 (Typ 3B) TDI | 1.9 | 85 | 01.99 - 12.99 | AJM | 4 | █ | Y-732J | 5605 | | D-POWER 4 | 5605 |
| Passat 4 (Typ 3B) TDI | 1.9 | 85 | 01.00 - 08.00 | ATJ | 4 | █ | Y-732J | 5605 | | D-POWER 4 | 5605 |
| Passat 4 (Typ 3B) TDI | 2.5 | 120 | 05.03 - 05.05 | BDG | 6 | █ | Y-501U | 3786 | | D-POWER 31 | 4187 |
| Passat 4 (Typ 3B) TDI | 2.5 | 132 | 01.03 - 05.05 | BAU | 6 | █ | Y-501U | 3786 | | D-POWER 31 | 4187 |
| Passat 4 (Typ 3B) TDI | 2.5 | 132 | 01.03 - 05.05 | BDH | 6 | █ | Y-501U | 3786 | | D-POWER 31 | 4187 |
| Passat 4 (Typ 3B) TDI | 1.9 | 74 | 10.00 - 05.05 | AVB | 4 | █ | Y-732J | 5605 | | D-POWER 4 | 5605 |
| Fgst → 3B-2-350-000 | | | | | | | | | | | |
| Passat 4 (Typ 3B) TDI | 1.9 | 96 | 10.00 - 05.05 | AVF | 4 | █ | Y-732J | 5605 | | D-POWER 4 | 5605 |
| Fgst → 3B-2-350-000 | | | | | | | | | | | |
| Passat 4 (Typ 3B) TDI | 1.9 | 96 | 10.00 - 05.05 | AWX | 4 | █ | Y-732J | 5605 | | D-POWER 4 | 5605 |
| Fgst → 3B-2-350-000 | | | | | | | | | | | |
| Passat 4 (Typ 3B) TDI | 1.9 | 74 | 10.00 - 05.05 | AVB | 4 | █ | Y-741U | 6943 | | D-POWER 20 | 6943 |
| Fgst 3B-2-350-001 → | | | | | | | | | | | |

Fgst = Chassis No.



ℓ kW



Cyl.

Order-
No. No.LPG/CNG
D-PowerOrder-
No.**VW**

| | | | | | | | | | | | |
|--------------------------|-----|-----|---------------|-------|----|-----|------------|------|----|------------|------|
| Passat 4 (Typ 3B) TDI | 1.9 | 96 | 10.00 - 05.05 | AVF | 4 | █ | Y-741U | 6943 | | D-POWER 20 | 6943 |
| Fgst 3B-2-350-001 → | | | | | | | | | | | |
| Passat 4 (Typ 3B) TDI | 1.9 | 96 | 10.00 - 05.05 | AWX | 4 | █ | Y-741U | 6943 | | D-POWER 20 | 6943 |
| Fgst 3B-2-350-001 → | | | | | | | | | | | |
| Passat 4 (Typ 3B) TDI V6 | 2.5 | 110 | 08.98 - 08.00 | AFB | 6 | █ | Y-501U | 3786 | | D-POWER 31 | 4187 |
| Passat 4 (Typ 3B) TDI V6 | 2.5 | 110 | 05.99 - 05.03 | AKN | 6 | █ | Y-501U | 3786 | | D-POWER 31 | 4187 |
| Passat 4 (Typ 3B) USA | 1.8 | 110 | 08.99 - 05.00 | ATW | 4 | 0,8 | PFR6Q | 6458 | 37 | LPG 1 | 1496 |
| Passat 4 (Typ 3B) USA | 1.8 | 110 | 05.00 - 08.00 | AUG | 4 | 0,8 | PFR6Q | 6458 | 37 | LPG 1 | 1496 |
| Passat 4 (Typ 3B) USA | 1.8 | 125 | 02.01 - 05.05 | AWM | 4 | 0,8 | PFR6Q | 6458 | 37 | LPG 1 | 1496 |
| Passat 5 (Typ 3C) | 2.0 | 147 | 07.05 - 11.05 | AXX | 4 | 0,8 | PFR7S8EG | 1675 | | | |
| Passat 5 (Typ 3C) | 1.6 | 75 | 05.05 - 05.07 | BSE | 4 | | BKUR6ET-10 | 2397 | 24 | LPG 1 | 1496 |
| Passat 5 (Typ 3C) | 1.6 | 75 | 05.05 - | BSF | 4 | | BKUR6ET-10 | 2397 | 24 | LPG 1 | 1496 |
| Passat 5 FSI (Typ 3C) | 2.0 | 147 | 08.05 - | BPY | 4 | 0,8 | PFR7S8EG | 1675 | | | |
| Passat 5 FSI (Typ 3C) | 2.0 | 147 | 11.05 - 12.07 | BWA | 4 | 0,8 | PFR7S8EG | 1675 | | | |
| Passat 5 FSI (Typ 3C) | 1.6 | 85 | 03.05 - | BLF | 4 | | ZFR6S-Q | 6449 | | ZFR6S-Q | 6449 |
| Passat 5 FSI (Typ 3C) | 2.0 | 110 | 03.05 - 11.05 | BLR | 4 | | PZFR5N-11T | 7742 | | PZFR5N-11T | 7742 |
| Passat 5 FSI (Typ 3C) | 2.0 | 110 | 09.05 - 11.05 | BLX | 4 | | PZFR5N-11T | 7742 | | PZFR5N-11T | 7742 |
| Passat 5 FSI (Typ 3C) | 2.0 | 110 | 03.05 - 11.05 | BLY | 4 | 0,9 | BKR6E | 6962 | 28 | LPG 1 | 1496 |
| Passat 5 FSI (Typ 3C) | 2.0 | 110 | 11.05 - | BVX | 4 | | PZFR5N-11T | 7742 | | PZFR5N-11T | 7742 |
| Passat 5 FSI (Typ 3C) | 2.0 | 110 | 11.05 - | BVY | 4 | | PZFR5N-11T | 7742 | | PZFR5N-11T | 7742 |
| Passat 5 FSI (Typ 3C) | 2.0 | 110 | 11.05 - | BVZ | 4 | 0,9 | BKR6E | 6962 | 28 | LPG 1 | 1496 |
| Passat 5 FSI (Typ 3C) | 3.2 | 184 | 09.05 - 05.07 | AXZ | 6 | 0,9 | ILZKR7A | 1961 | | ILZKR7A | 1961 |
| Passat 5 FSI (Typ 3C) | 3.6 | 206 | 09.05 - | BLV | 6 | 0,9 | ILZKR7A | 1961 | | ILZKR7A | 1961 |
| Passat 5 FSI (Typ 3C) | 1.8 | 118 | 11.09 - | CDA A | 4 | 0,8 | PFR7S8EG | 1675 | | | |
| Passat 5 TDI (Typ 3C) | 1.9 | 77 | 03.05 - 02.06 | BKC | 4 | █ | Y-607AS | 7560 | | D-POWER 50 | 7560 |
| Passat 5 TDI (Typ 3C) | 1.9 | 77 | 06.05 - 05.07 | BLS | 4 | █ | Y-607AS | 7560 | | D-POWER 50 | 7560 |
| Passat 5 TDI (Typ 3C) | 1.9 | 77 | 02.06 - | BXE | 4 | █ | Y-607AS | 7560 | | D-POWER 50 | 7560 |
| Passat 5 TDI (Typ 3C) | 2.0 | 88 | 11.05 - 05.07 | BWV | 4 | █ | CZ304 | 9864 | | D-POWER 55 | 9864 |
| Passat 5 TDI (Typ 3C) | 2.0 | 90 | 06.05 - | BVD | 4 | █ | CZ104 | 9826 | | D-POWER 52 | 9826 |
| Passat 5 TDI (Typ 3C) | 2.0 | 90 | 06.05 - 02.06 | BVE | 4 | █ | CZ304 | 9864 | | D-POWER 55 | 9864 |
| Passat 5 TDI (Typ 3C) | 2.0 | 100 | 03.05 - | BMA | 4 | █ | CZ304 | 9864 | | D-POWER 55 | 9864 |
| Passat 5 TDI (Typ 3C) | 2.0 | 100 | 01.08 - | CBAA | 4 | █ | Y-609AS | 5849 | | D-POWER 49 | 5849 |
| Passat 5 TDI (Typ 3C) | 2.0 | 103 | 03.05 - | BKP | 4 | █ | CZ304 | 9864 | | D-POWER 55 | 9864 |
| Passat 5 TDI (Typ 3C) | 2.0 | 103 | 03.05 - | BMP | 4 | █ | CZ104 | 9826 | | D-POWER 52 | 9826 |
| Passat 5 TDI (Typ 3C) | 2.0 | 103 | 05.07 - | CBAB | 4 | █ | Y-609AS | 5849 | | D-POWER 49 | 5849 |
| Passat 5 TDI (Typ 3C) | 2.0 | 120 | 10.05 - | BUZ | 4 | █ | CZ304 | 9864 | | D-POWER 55 | 9864 |
| Passat 5 TDI (Typ 3C) | 2.0 | 125 | 02.06 - | BMR | 4 | █ | CZ304 | 9864 | | D-POWER 55 | 9864 |
| Passat 5 TDI (Typ 3C) | 2.0 | 125 | 05.08 - | CBBB | 4 | █ | Y-609AS | 5849 | | D-POWER 49 | 5849 |
| Passat 5 TDI (Typ 3C) | 2.0 | 100 | 11.10 - | CFFA | 4 | █ | Y1002AS | 8888 | | D-POWER 57 | 8888 |
| Passat 5 TSI (Typ 3C) | 1.8 | 118 | 06.07 - | BZB | 4 | 0,8 | PFR7S8EG | 1675 | | | |
| Passat 5 TSI (Typ 3C) | 1.4 | 90 | 05.07 - | CAXA | 4 | 0,9 | PZFR6R | 5758 | | PZFR6R | 5758 |
| Passat 5 TSI (Typ 3C) | 1.8 | 112 | 11.08 - 05.10 | CGYA | 4 | 0,8 | PFR7S8EG | 1675 | | | |
| Passat 5 TSI (Typ 3C) | 2.0 | 125 | 12.07 - | CCTA | 4 | 0,8 | PFR7S8EG | 1675 | | | |
| Passat 5 TSI (Typ 3C) | 2.0 | 125 | 12.07 - | CCTB | 4 | 0,8 | PFR7S8EG | 1675 | | | |
| Passat 5 TSI (Typ 3C) | 2.0 | 147 | 11.07 - 01.10 | CAWB | 4 | 0,8 | PFR7S8EG | 1675 | | | |
| Passat 5 TSI (Typ 3C) | 2.0 | 147 | 11.09 - | CCZA | 4 | 0,8 | PFR7S8EG | 1675 | | | |
| Phaeton | 3.2 | 177 | 05.02 - 05.05 | AYT | 6 | 0,9 | IZKR7B | 7563 | | IZKR7B | 7563 |
| Phaeton | 3.2 | 177 | 08.03 - 10.08 | BKL | 6 | 0,9 | IZKR7B | 7563 | | IZKR7B | 7563 |
| Phaeton | 3.6 | 206 | 11.08 - 05.10 | CHNA | 6 | 0,9 | ILZKR7A | 1961 | | ILZKR7A | 1961 |
| Phaeton | 4.2 | 246 | 08.03 - | BGH | 8 | | BKR6EQUA | 6872 | | LPG 1 | 1496 |
| Phaeton | 4.2 | 246 | 05.03 - 07.03 | BGJ | 8 | | BKR6EQUA | 6872 | | LPG 1 | 1496 |
| Phaeton | 6.0 | 309 | 05.02 - 05.05 | BAN | 12 | 1,1 | PZFR6J-11 | 3586 | | LPG 6 | 1565 |

Fgst = Chassis No.



ℓ kW

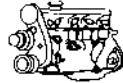

Cyl.

Order-
No. No.LPG/CNG
D-PowerOrder-
No.**VW**

| | | | | | | | | | | | |
|----------------------|-----|-----|-------------|------|----|-----|------------|------|----|------------|------|
| Phaeton | 6.0 | 309 | 10.03- | BAP | 12 | 1,1 | PZFR6J-11 | 3586 | | LPG 6 | 1565 |
| Phaeton | 6.0 | 331 | 05.05-10.08 | BRN | 12 | 1,1 | PZFR6J-11 | 3586 | | LPG 6 | 1565 |
| Phaeton | 6.0 | 331 | 05.05-10.08 | BTT | 12 | 1,1 | PZFR6J-11 | 3586 | | LPG 6 | 1565 |
| Phaeton TDI | 3.0 | 171 | 09.04-05.07 | BMK | 6 | █ | Y-609AS | 5849 | | D-POWER 49 | 5849 |
| Phaeton TDI | 3.0 | 172 | 06.07-10.08 | CARA | 6 | █ | Y-609AS | 5849 | | D-POWER 49 | 5849 |
| Phaeton TDI | 3.0 | 176 | 05.08-05.10 | CEXA | 6 | █ | Y-609AS | 5849 | | D-POWER 49 | 5849 |
| Phaeton TDI | 5.0 | 230 | 12.02-10.06 | AJS | 10 | █ | Y-741U | 6943 | | D-POWER 20 | 6943 |
| Pointer /Gol (RUS) | 1.0 | | 05- | (8V) | 4 | 1,1 | PZFR5D-11 | 7968 | 34 | LPG 6 | 1565 |
| Polo 2 (Typ 86C) | 1.0 | 29 | 08.81-10.86 | GL | 4 | 0,7 | BP6ES | 7811 | 4 | LPG 2 | 1497 |
| Polo 2 (Typ 86C) | 1.0 | 33 | 01.90-07.90 | AAK | 4 | | BUR6ET | 3172 | 1 | LPG 2 | 1497 |
| Polo 2 (Typ 86C) | 1.0 | 33 | 10.90-07.94 | AAU | 4 | | BUR5ET | 3377 | 22 | LPG 2 | 1497 |
| Polo 2 (Typ 86C) | 1.0 | 33 | 08.89-12.92 | ACM | 4 | | BUR6ET | 3172 | 1 | LPG 2 | 1497 |
| Polo 2 (Typ 86C) | 1.0 | 33 | 08.85-08.88 | HZ | 4 | | BUR6ET | 3172 | 1 | LPG 2 | 1497 |
| Polo 2 (Typ 86C) | 1.0 | 33 | 08.88-07.89 | HZ | 4 | 0,7 | BP6ESZ | 7639 | | LPG 2 | 1497 |
| Polo 2 (Typ 86C) | 1.0 | 33 | 08.89-01.92 | HZ | 4 | | BUR6ET | 3172 | 1 | LPG 2 | 1497 |
| Polo 2 (Typ 86C) | 1.3 | 37 | 08.85-08.88 | NU | 4 | | BUR6ET | 3172 | 1 | LPG 2 | 1497 |
| Polo 2 (Typ 86C) | 1.3 | 37 | 08.88-07.89 | NU | 4 | 0,7 | BP6ESZ | 7639 | | LPG 2 | 1497 |
| Polo 2 (Typ 86C) | 1.3 | 40 | 01.89-07.94 | 2G | 4 | | BUR6ET | 3172 | 1 | LPG 2 | 1497 |
| Polo 2 (Typ 86C) | 1.3 | 40 | 01.91-07.94 | AAV | 4 | | BUR5ET | 3377 | 22 | LPG 2 | 1497 |
| Polo 2 (Typ 86C) | 1.3 | 40 | 08.83-07.85 | HK | 4 | 0,7 | BP6ES | 7811 | 4 | LPG 2 | 1497 |
| Polo 2 (Typ 86C) | 1.3 | 40 | 08.85-08.88 | MH | 4 | | BUR6ET | 3172 | 1 | LPG 2 | 1497 |
| Polo 2 (Typ 86C) | 1.3 | 40 | 08.88-07.89 | MH | 4 | 0,7 | BP6ESZ | 7639 | | LPG 2 | 1497 |
| Polo 2 (Typ 86C) | 1.3 | 40 | 08.89-08.91 | MH | 4 | | BUR6ET | 3172 | 1 | LPG 2 | 1497 |
| Polo 2 (Typ 86C) | 1.3 | 40 | 05.86-08.88 | NZ | 4 | | BUR6ET | 3172 | 1 | LPG 2 | 1497 |
| Polo 2 (Typ 86C) | 1.3 | 40 | 08.88-07.89 | NZ | 4 | 0,7 | BP6ESZ | 7639 | | LPG 2 | 1497 |
| Polo 2 (Typ 86C) | 1.3 | 40 | 08.89-12.92 | NZ | 4 | | BUR6ET | 3172 | 1 | LPG 2 | 1497 |
| Polo 2 (Typ 86C) | 1.3 | 55 | 01.90-07.94 | 3F | 4 | | BUR6ET | 3172 | 1 | LPG 2 | 1497 |
| Polo 2 (Typ 86C) | 1.3 | 55 | 07.82-08.88 | GK | 4 | | BUR6ET | 3172 | 1 | LPG 2 | 1497 |
| Polo 2 (Typ 86C) | 1.3 | 55 | 08.88-07.89 | GK | 4 | 0,8 | BP7ES | 2412 | | BPR8EIX | 6684 |
| Polo 2 (Typ 86C) | 1.3 | 55 | 08.89-07.90 | GK | 4 | | BUR6ET | 3172 | 1 | LPG 2 | 1497 |
| Polo 2 (Typ 86C) D | 1.3 | 33 | 08.85-07.90 | MN | 4 | █ | Y-918J | 6285 | | D-POWER 2 | 6285 |
| Polo 2 (Typ 86C) D | 1.4 | 35 | 10.90-07.94 | 1W | 4 | █ | Y-918J | 6285 | | D-POWER 2 | 6285 |
| Polo 2 (Typ 86C) G40 | 1.3 | 82 | 08.86-09.90 | PY | 4 | | only OES | | | | |
| Polo 2 (Typ 86C) G40 | 1.3 | 82 | 10.90-07.94 | PY | 4 | | only OES | | | | |
| Polo 3 (Typ 6N) | 1.0 | 33 | 10.94-06.96 | AEV | 4 | | BUR6ET | 3172 | 1 | LPG 2 | 1497 |
| Polo 3 (Typ 6N) | 1.0 | 37 | 07.96-12.99 | AER | 4 | | BUR6ET | 3172 | 1 | LPG 2 | 1497 |
| Polo 3 (Typ 6N) | 1.0 | 37 | 10.99-09.01 | ALD | 4 | 1,1 | PZFR5D-11 | 7968 | 34 | LPG 6 | 1565 |
| Polo 3 (Typ 6N) | 1.0 | 37 | 08.97-12.99 | ALL | 4 | | BUR6ET | 3172 | 1 | LPG 2 | 1497 |
| Polo 3 (Typ 6N) | 1.0 | 37 | 10.99-09.01 | AUC | 4 | 1,1 | PZFR5D-11 | 7968 | 34 | LPG 6 | 1565 |
| Polo 3 (Typ 6N) | 1.3 | 40 | 10.94-04.97 | ADX | 4 | | BUR6ET | 3172 | 1 | LPG 2 | 1497 |
| Polo 3 (Typ 6N) | 1.4 | 40 | 10.99-09.01 | AKP | 4 | 1,1 | PZFR5D-11 | 7968 | 34 | LPG 6 | 1565 |
| Polo 3 (Typ 6N) | 1.4 | 44 | 07.95-12.97 | AEX | 4 | | BUR6ET | 3172 | 1 | LPG 2 | 1497 |
| Polo 3 (Typ 6N) | 1.4 | 44 | 10.99-09.01 | AKK | 4 | 1,1 | PZFR5D-11 | 7968 | 34 | LPG 6 | 1565 |
| Polo 3 (Typ 6N) | 1.4 | 44 | 05.97-12.99 | AKV | 4 | | BUR6ET | 3172 | 1 | LPG 2 | 1497 |
| Polo 3 (Typ 6N) | 1.4 | 44 | 10.99-08.00 | ANW | 4 | 1,1 | PZFR5D-11 | 7968 | 34 | LPG 6 | 1565 |
| Polo 3 (Typ 6N) | 1.4 | 44 | 01.98-12.99 | ANX | 4 | | BUR6ET | 3172 | 1 | LPG 2 | 1497 |
| Polo 3 (Typ 6N) | 1.4 | 44 | 11.97-12.99 | APQ | 4 | | BUR6ET | 3172 | 1 | LPG 2 | 1497 |
| Polo 3 (Typ 6N) | 1.4 | 44 | 10.99-09.01 | AUD | 4 | 1,1 | PZFR5D-11 | 7968 | 34 | LPG 6 | 1565 |
| Polo 3 (Typ 6N) | 1.4 | 55 | 10.99-09.01 | AHW | 4 | | BKUR6ET-10 | 2397 | 24 | LPG 1 | 1496 |
| Polo 3 (Typ 6N) | 1.4 | 55 | 10.99-06.00 | APE | 4 | | BKUR6ET-10 | 2397 | 24 | LPG 1 | 1496 |
| Polo 3 (Typ 6N) | 1.4 | 55 | 10.99-01.02 | AUA | 4 | | BKUR6ET-10 | 2397 | 24 | LPG 1 | 1496 |
| Polo 3 (Typ 6N) | 1.4 | 74 | 04.96-12.99 | AFH | 4 | | BKUR6ET-10 | 2397 | 24 | LPG 1 | 1496 |



ℓ kW

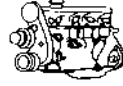

Cyl.

Order-
No. No.LPG/CNG
D-PowerOrder-
No.**VW**

| | | | | | | | | | | | |
|--------------------------------|-----|----|---------------|------|---|-----|------------|------|----|------------|------|
| Polo 3 (Typ 6N) | 1.4 | 74 | 10.99 - 09.01 | AFK | 4 | | BKUR6ET-10 | 2397 | 24 | LPG 1 | 1496 |
| Polo 3 (Typ 6N) | 1.4 | 74 | 07.99 - 05.00 | AQQ | 4 | | BKUR6ET-10 | 2397 | 24 | LPG 1 | 1496 |
| Polo 3 (Typ 6N) | 1.4 | 74 | 05.00 - 06.02 | AUB | 4 | | BKUR6ET-10 | 2397 | 24 | LPG 1 | 1496 |
| Polo 3 (Typ 6N) | 1.6 | 55 | 10.94 - 09.97 | 1F | 4 | | BUR5ET | 3377 | 22 | LPG 2 | 1497 |
| Polo 3 (Typ 6N) | 1.6 | 55 | 10.94 - 07.95 | AEA | 4 | | BUR6ET | 3172 | 1 | LPG 2 | 1497 |
| Polo 3 (Typ 6N) | 1.6 | 55 | 07.95 - 12.99 | AEE | 4 | | BUR6ET | 3172 | 1 | LPG 2 | 1497 |
| Polo 3 (Typ 6N) | 1.6 | 55 | 07.98 - 09.01 | ALM | 4 | | BUR6ET | 3172 | 1 | LPG 2 | 1497 |
| Polo 3 (Typ 6N) | 1.6 | 74 | 10.99 - 09.01 | AEH | 4 | | BKUR6ET-10 | 2397 | 24 | LPG 1 | 1496 |
| Polo 3 (Typ 6N) | 1.6 | 74 | 10.99 - 09.01 | AKL | 4 | | BKUR6ET-10 | 2397 | 24 | LPG 1 | 1496 |
| Polo 3 (Typ 6N) | 1.6 | 74 | 03.00 - 10.00 | APF | 4 | | BKUR6ET-10 | 2397 | 24 | LPG 1 | 1496 |
| Polo 3 (Typ 6N) | 1.6 | 74 | 07.00 - 09.01 | AUR | 4 | | BKUR6ET-10 | 2397 | 24 | LPG 1 | 1496 |
| Polo 3 (Typ 6N) | 1.6 | 92 | 11.99 - 09.01 | ARC | 4 | | BKUR6ET-10 | 2397 | 24 | LPG 1 | 1496 |
| Polo 3 (Typ 6N) | 1.6 | 92 | 05.00 - 09.01 | AVY | 4 | | BKUR6ET-10 | 2397 | 24 | LPG 1 | 1496 |
| Polo 3 (Typ 6N) | 1.9 | 47 | 01.96 - 10.96 | 1Y | 4 | ☑ | Y-918J | 6285 | | D-POWER 2 | 6285 |
| Polo 3 (Typ 6N) | 1.9 | 47 | 10.94 - 12.99 | AEF | 4 | ☑ | Y-918J | 6285 | | D-POWER 2 | 6285 |
| Polo 3 (Typ 6N) | 1.9 | 47 | 12.95 - 08.99 | AEY | 4 | ☑ | Y-732J | 5605 | | D-POWER 4 | 5605 |
| Polo 3 (Typ 6N) (Mexiko) | 2.0 | 85 | 08.99 - 09.01 | ADC | 4 | | BKR5EVX | 2546 | | LPG 1 | 1496 |
| Polo 3 (Typ 6N) Classic | 1.8 | 66 | 03.98 - 09.01 | ADD | 4 | | BUR6ET | 3172 | 1 | LPG 2 | 1497 |
| Polo 3 (Typ 6N) GTI | 1.6 | 88 | 08.98 - 12.99 | AJV | 4 | | BKUR6ET-10 | 2397 | 24 | LPG 1 | 1496 |
| Polo 3 (Typ 6N) (only Japan) | 1.6 | 55 | 03.96 - 12.99 | AHS | 4 | | BPR5EKU | 5685 | | LPG 2 | 1497 |
| Polo 3 (Typ 6N) SDI | 1.7 | 42 | 04.97 - 12.99 | AHG | 4 | ☑ | Y-732J | 5605 | | D-POWER 4 | 5605 |
| Polo 3 (Typ 6N) SDI | 1.7 | 42 | 08.97 - 04.00 | AKU | 4 | ☑ | Y-732J | 5605 | | D-POWER 4 | 5605 |
| Polo 3 (Typ 6N) SDI | 1.7 | 44 | 11.97 - 08.99 | AKW | 4 | ☑ | Y-732J | 5605 | | D-POWER 4 | 5605 |
| Polo 3 (Typ 6N) SDI | 1.9 | 47 | 07.96 - 09.01 | AGD | 4 | ☑ | Y-732J | 5605 | | D-POWER 4 | 5605 |
| Polo 3 (Typ 6N) SDI | 1.9 | 47 | 10.99 - 09.01 | ASX | 4 | ☑ | Y-732J | 5605 | | D-POWER 4 | 5605 |
| Polo 3 (Typ 6N) SDI | 1.9 | 50 | 10.99 - 09.01 | AGP | 4 | ☑ | Y-732J | 5605 | | D-POWER 4 | 5605 |
| Polo 3 (Typ 6N) SDI | 1.9 | 50 | 10.99 - 09.01 | AQM | 4 | ☑ | Y-732J | 5605 | | D-POWER 4 | 5605 |
| Polo 3 (Typ 6N) TDI | 1.4 | 55 | 10.99 - 05.05 | AMF | 3 | ☑ | Y-741U | 6943 | | D-POWER 20 | 6943 |
| Polo 3 (Typ 6N) TDI | 1.4 | 66 | 01.00 - 04.00 | ATL | 3 | ☑ | Y-741U | 6943 | | D-POWER 20 | 6943 |
| Polo 3 (Typ 6N) TDI | 1.9 | 66 | 10.99 - 09.01 | AGR | 4 | ☑ | Y-732J | 5605 | | D-POWER 4 | 5605 |
| Polo 3 (Typ 6N) TDI | 1.9 | 66 | 01.97 - 08.99 | AHU | 4 | ☑ | Y-732J | 5605 | | D-POWER 4 | 5605 |
| Polo 3 (Typ 6N) TDI | 1.9 | 66 | 11.97 - 08.99 | ALE | 4 | ☑ | Y-732J | 5605 | | D-POWER 4 | 5605 |
| Polo 3 (Typ 6N) TDI | 1.9 | 66 | 10.99 - 09.01 | ALH | 4 | ☑ | Y-732J | 5605 | | D-POWER 4 | 5605 |
| Polo 3 (Typ 6N) TDI | 1.9 | 81 | 06.98 - 08.99 | AFN | 4 | ☑ | Y-732J | 5605 | | D-POWER 4 | 5605 |
| Polo 3 (Typ 6N) TDI | 1.9 | 81 | 10.99 - 09.01 | ASV | 4 | ☑ | Y-732J | 5605 | | D-POWER 4 | 5605 |
| Polo 3 (Typ 6N) Variant | 1.6 | 74 | 12.95 - 08.99 | AFT | 4 | | BKUR6ET-10 | 2397 | 24 | LPG 1 | 1496 |
| Polo 4 (Typ 9N) | 1.2 | 40 | 01.02 - 05.04 | AWY | 3 | 0,9 | ZFR5P-G | 6893 | | LPG 6 | 1565 |
| Polo 4 (Typ 9N) | 1.2 | 40 | 05.04 - 05.07 | BMD | 3 | 0,9 | ZFR5P-G | 6893 | | LPG 6 | 1565 |
| Polo 4 (Typ 9N) | 1.2 | 44 | 05.07 - | BBM | 3 | 0,9 | ZFR5P-G | 6893 | | LPG 6 | 1565 |
| Polo 4 (Typ 9N) | 1.2 | 44 | 06.09 - | CGPB | 4 | 1,1 | ZFR6T-11G | 5960 | | ZFR6T-11G | 5960 |
| Polo 4 (Typ 9N) | 1.2 | 47 | 11.04 - 07.07 | BME | 3 | 0,9 | ZFR5P-G | 6893 | | LPG 6 | 1565 |
| Polo 4 (Typ 9N) | 1.2 | 51 | 06.09 - | CGPA | 4 | 1,1 | ZFR6T-11G | 5960 | | ZFR6T-11G | 5960 |
| Polo 4 (Typ 9N) | 1.2 | 52 | 05.07 - | BZG | 3 | 0,9 | ZFR5P-G | 6893 | | LPG 6 | 1565 |
| Polo 4 (Typ 9N) | 1.2 | 55 | 03.10 - | CJLA | 3 | 1,1 | ZFR6T-11G | 5960 | | ZFR6T-11G | 5960 |
| Polo 4 (Typ 9N) | 1.4 | 59 | 05.06 - | BUD | 4 | 1,1 | ZFR6T-11G | 5960 | | ZFR6T-11G | 5960 |
| Polo 4 (Typ 9N) | 1.4 | 63 | 06.09 - | CGGB | 4 | 1,1 | ZFR6T-11G | 5960 | | ZFR6T-11G | 5960 |
| Polo 4 (Typ 9N) | 1.6 | 77 | 05.06 - | BTS | 4 | 1,1 | ZFR6T-11G | 5960 | | ZFR6T-11G | 5960 |
| Polo 4 (Typ 9N) 16V | 1.4 | 55 | 11.01 - 05.04 | BBY | 4 | | BKUR6ET-10 | 2397 | 24 | LPG 1 | 1496 |
| Polo 4 (Typ 9N) 16V | 1.4 | 55 | 05.04 - 05.08 | BKY | 4 | 0,9 | ZFR5P-G | 6893 | | LPG 6 | 1565 |
| Polo 4 (Typ 9N) 16V | 1.4 | 74 | 05.02 - 05.08 | BBZ | 4 | | BKUR6ET-10 | 2397 | 24 | LPG 1 | 1496 |
| Polo 4 (Typ 9N) 16V Automatic | 1.4 | 55 | 11.01 - 05.04 | BBY | 4 | 1,1 | PZFR5D-11 | 7968 | 34 | LPG 6 | 1565 |
| Polo 4 (Typ 9N) 12V | 1.2 | 47 | 11.01 - 05.04 | AZQ | 3 | 0,9 | ZFR5P-G | 6893 | | LPG 6 | 1565 |



ℓ kW

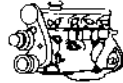

Cyl.

Order-
No. No.LPG/CNG
D-PowerOrder-
No.**VW**

| | | | | | | | | | | | |
|---------------------|-----|-----|-------------|------|---|-----|-----------|------|----|------------|------|
| Polo 4 (Typ 9N) FSI | 1.4 | 63 | 02.02-07.06 | AXU | 4 | | ZFR6S-Q | 6449 | | ZFR6S-Q | 6449 |
| Polo 4 (Typ 9N) GTI | 1.8 | 110 | 09.05- | BJX | 4 | 0,8 | PFR6Q | 6458 | 37 | LPG 1 | 1496 |
| Polo 4 (Typ 9N) GTI | 1.8 | 132 | 05.06- | BBU | 4 | 0,8 | PFR6Q | 6458 | 37 | LPG 1 | 1496 |
| Polo 4 (Typ 9N) LPG | 1.4 | 60 | 11.09- | CMAA | 4 | 1,1 | ZFR6T-11G | 5960 | | ZFR6T-11G | 5960 |
| Polo 4 (Typ 9N) SDI | 1.9 | 47 | 11.01- | ASY | 4 | █ | Y-732J | 5605 | | D-POWER 4 | 5605 |
| Polo 4 (Typ 9N) TDI | 1.4 | 51 | 04.05- | BNM | 3 | █ | Y-741U | 6943 | | D-POWER 20 | 6943 |
| Polo 4 (Typ 9N) TDI | 1.4 | 51 | 05.06- | BWB | 3 | █ | CZ104 | 9826 | | D-POWER 52 | 9826 |
| Polo 4 (Typ 9N) TDI | 1.4 | 55 | 11.01-05.05 | BAY | 3 | █ | Y-741U | 6943 | | D-POWER 20 | 6943 |
| Polo 4 (Typ 9N) TDI | 1.4 | 59 | 10.05- | BMS | 3 | █ | CZ104 | 9826 | | D-POWER 52 | 9826 |
| Polo 4 (Typ 9N) TDI | 1.4 | 59 | 04.05- | BNV | 3 | █ | Y-741U | 6943 | | D-POWER 20 | 6943 |
| Polo 4 (Typ 9N) TDI | 1.6 | 55 | 06.09- | CAYA | 4 | █ | Y1002AS | 8888 | | D-POWER 57 | 8888 |
| Polo 4 (Typ 9N) TDI | 1.6 | 66 | 06.09- | CAYB | 4 | █ | Y1002AS | 8888 | | D-POWER 57 | 8888 |
| Polo 4 (Typ 9N) TDI | 1.6 | 77 | 06.09- | CAYC | 4 | █ | Y1002AS | 8888 | | D-POWER 57 | 8888 |
| Polo 4 (Typ 9N) TDI | 1.9 | 74 | 11.01- | ATD | 4 | █ | Y-741U | 6943 | | D-POWER 20 | 6943 |
| Polo 4 (Typ 9N) TDI | 1.9 | 74 | 11.01- | AXR | 4 | █ | Y-741U | 6943 | | D-POWER 20 | 6943 |
| Polo 4 (Typ 9N) TDI | 1.9 | 74 | 05.06- | BMT | 4 | █ | Y-607AS | 7560 | | D-POWER 50 | 7560 |
| Polo 4 (Typ 9N) TDI | 1.9 | 96 | 11.03- | ASZ | 4 | █ | Y-741U | 6943 | | D-POWER 20 | 6943 |
| Polo 4 (Typ 9N) TDI | 1.9 | 96 | 05.04- | BLT | 4 | █ | Y-741U | 6943 | | D-POWER 20 | 6943 |
| Polo 5 (Typ 6R) | 1.2 | 44 | 06.09- | CGPB | 4 | 1,1 | ZFR6T-11G | 5960 | | ZFR6T-11G | 5960 |
| Polo 5 (Typ 6R) | 1.2 | 51 | 06.09- | CGPA | 4 | 1,1 | ZFR6T-11G | 5960 | | ZFR6T-11G | 5960 |
| Polo 5 (Typ 6R) | 1.4 | 63 | 06.09- | CGGB | 4 | 1,1 | ZFR6T-11G | 5960 | | ZFR6T-11G | 5960 |
| Polo 5 (Typ 6R) GTI | 1.4 | 132 | 05.10- | CAVE | 4 | 0,9 | PZFR6R | 5758 | | PZFR6R | 5758 |
| Polo 5 (Typ 6R) TDI | 1.6 | 55 | 05.09- | CAYA | 4 | █ | Y1002AS | 8888 | | D-POWER 57 | 8888 |
| Polo 5 (Typ 6R) TDI | 1.6 | 66 | 06.09- | CAYB | 4 | █ | Y1002AS | 8888 | | D-POWER 57 | 8888 |
| Polo 5 (Typ 6R) TDI | 1.6 | 77 | 05.09- | CAYC | 4 | █ | Y1002AS | 8888 | | D-POWER 57 | 8888 |
| Polo 5 (Typ 6R) TDI | 1.6 | 77 | 05.09- | CLNA | 4 | █ | Y1002AS | 8888 | | D-POWER 57 | 8888 |
| Santana | 1.3 | 44 | 08.83-12.84 | | 4 | 0,7 | BP6ES | 7811 | 4 | LPG 2 | 1497 |
| Santana | 1.6 | 40 | 08.81-07.82 | CR | 4 | █ | Y-918J | 6285 | | D-POWER 2 | 6285 |
| Santana | 1.6 | 40 | 08.82-12.84 | JK | 4 | █ | Y-918J | 6285 | | D-POWER 2 | 6285 |
| Santana | 1.6 | 55 | 08.81-12.84 | | 4 | 0,7 | BP6ES | 7811 | 4 | LPG 2 | 1497 |
| Santana | 1.6 | 55 | 08.83-12.84 | DT | 4 | | BUR5ET-10 | 7264 | 21 | LPG 2 | 1497 |
| Santana | 1.6 | 55 | 08.83-07.84 | JU | 4 | | BUR5ET-10 | 7264 | 21 | LPG 2 | 1497 |
| Santana | 1.6 | 55 | 08.81-07.83 | WV | 4 | 0,7 | BP6ES | 7811 | 4 | LPG 2 | 1497 |
| Santana | 1.6 | 63 | 08.81-12.82 | YP | 4 | 0,7 | BP6ES | 7811 | 4 | LPG 2 | 1497 |
| Santana | 1.8 | 66 | 01.83-12.84 | DS | 4 | | BUR6ET | 3172 | 1 | LPG 2 | 1497 |
| Santana | 1.8 | 66 | 08.82-12.84 | JN | 4 | | BUR6ET | 3172 | 1 | LPG 2 | 1497 |
| Santana | 1.8 | 68 | 08.84-12.84 | | 4 | | BUR6ET | 3172 | 1 | LPG 2 | 1497 |
| Santana | 1.9 | 85 | 08.81-07.83 | WN | 4 | 0,8 | BP7ES | 2412 | | BPR8EIX | 6684 |
| Santana | 2.0 | 85 | 08.83-12.84 | JS | 5 | | BUR6ET | 3172 | 1 | LPG 2 | 1497 |
| Santana TD | 1.6 | 51 | 12.81-12.84 | CY | 4 | █ | Y-918J | 6285 | | D-POWER 2 | 6285 |
| Santana D,TD | 1.6 | 40 | 08.81-12.84 | | 4 | █ | Y-918J | 6285 | | D-POWER 2 | 6285 |
| Scirocco | 1.3 | 40 | 08.83-07.84 | HK | 4 | 0,7 | BP6ES | 7811 | 4 | LPG 2 | 1497 |
| Scirocco | 1.3 | 44 | 08.81-07.83 | GF | 4 | 0,7 | BP6ES | 7811 | 4 | LPG 2 | 1497 |
| Scirocco | 1.5 | 51 | 08.83-07.84 | EWA | 4 | | BUR5ET-10 | 7264 | 21 | LPG 2 | 1497 |
| Scirocco | 1.5 | 51 | 08.80-12.80 | JB | 4 | 0,8 | BP5ES | 6511 | 8 | LPG 2 | 1497 |
| Scirocco | 1.6 | 53 | 04.86-07.90 | RE | 4 | | BUR5ET-10 | 7264 | 21 | LPG 2 | 1497 |
| Scirocco | 1.6 | 55 | 01.83-07.91 | EW | 4 | | BUR5ET-10 | 7264 | 21 | LPG 2 | 1497 |
| Scirocco | 1.6 | 55 | 08.83-07.86 | HN | 4 | | BUR5ET-10 | 7264 | 21 | LPG 2 | 1497 |
| Scirocco | 1.8 | 66 | 08.83-07.92 | EX | 4 | | BUR6ET | 3172 | 1 | LPG 2 | 1497 |
| Scirocco | 1.8 | 70 | 08.83-07.92 | JH | 4 | | BUR6ET | 3172 | 1 | LPG 2 | 1497 |
| Scirocco | 1.8 | 82 | 08.82-07.92 | DX | 4 | | BUR6ET | 3172 | 1 | LPG 2 | 1497 |
| Scirocco | 1.8 | 82 | 08.82-07.91 | JJ | 4 | | BUR6ET | 3172 | 1 | LPG 2 | 1497 |



ℓ kW



Cyl.

Order-
No. No.LPG/CNG
D-PowerOrder-
No.**VW**

| | | | | | | | | | | | |
|-------------------|-----|-----|---------------|------|---|-----|------------|------|----|------------|------|
| Scirocco | 1.8 | 82 | 08.83 - 07.91 | KT | 4 | | BUR6ET | 3172 | 1 | LPG 2 | 1497 |
| Scirocco | 1.8 | 95 | 02.86 - 07.92 | PL | 4 | | BKUR7ET | 7873 | | PFR7Q | 7963 |
| Scirocco 16V | 1.8 | 102 | 08.84 - 07.89 | KR | 4 | | BCPR7ET | 2164 | | BCPR7EIX | 5690 |
| Scirocco 2 TDI | 2.0 | 103 | 08.08 - | CBDB | 4 | █ | Y1002AS | 8888 | | D-POWER 57 | 8888 |
| Scirocco 2 TDI | 2.0 | 125 | 05.09 - | CBBB | 4 | █ | Y1002AS | 8888 | | D-POWER 57 | 8888 |
| Scirocco 2 TFSI | 1.4 | 90 | 11.08 - | CAXA | 4 | 0,9 | PZFR6R | 5758 | | PZFR6R | 5758 |
| Scirocco 2 TFSI | 2.0 | 147 | 08.08 - | CAWB | 4 | 0,8 | PFR7S8EG | 1675 | | | |
| Scirocco 2 TSI | 1.4 | 118 | 08.08 - | CAVD | 4 | 0,9 | PZFR6R | 5758 | | PZFR6R | 5758 |
| Sharan | 2.0 | 85 | 09.95 - 02.00 | ADY | 4 | | BKUR6ET-10 | 2397 | 24 | LPG 1 | 1496 |
| Sharan TDI | 1.9 | 66 | 09.95 - 07.96 | 1Z | 4 | █ | Y-732J | 5605 | | D-POWER 4 | 5605 |
| Sharan TDI | 1.9 | 66 | 08.96 - 02.00 | AHU | 4 | █ | Y-732J | 5605 | | D-POWER 4 | 5605 |
| Sharan TDI | 1.9 | 66 | 03.99 - | ANU | 4 | █ | Y-741U | 6943 | | D-POWER 20 | 6943 |
| Sharan TDI | 1.9 | 81 | 02.96 - 07.99 | AFN | 4 | █ | Y-732J | 5605 | | D-POWER 4 | 5605 |
| Sharan TDI | 1.9 | 81 | 08.99 - 02.00 | AVG | 4 | █ | Y-732J | 5605 | | D-POWER 4 | 5605 |
| Sharan TDI | 1.9 | 85 | 04.00 - | AUY | 4 | █ | Y-741U | 6943 | | D-POWER 20 | 6943 |
| Sharan TDI | 1.9 | 96 | 11.02 - | ASZ | 4 | █ | Y-741U | 6943 | | D-POWER 20 | 6943 |
| Sharan turbo | 1.8 | 110 | 11.97 - 02.00 | AJH | 4 | 0,8 | PFR6Q | 6458 | 37 | LPG 1 | 1496 |
| Sharan VR6 | 2.8 | 128 | 09.95 - 03.98 | AAA | 6 | | BKR5EKUP | 2890 | | | |
| Sharan VR6 | 2.8 | 128 | 04.98 - 02.00 | AMY | 6 | | BKR5EKUP | 2890 | | | |
| Sharan 2 | 1.8 | 110 | 04.00 - 05.05 | AWC | 4 | | PFR6Q | 6458 | 37 | LPG 1 | 1496 |
| Sharan 2 | 1.9 | 110 | 01.05 - 05.07 | BTB | 4 | █ | Y-741U | 6943 | | D-POWER 20 | 6943 |
| Sharan 2 LPG | 2.0 | 85 | 04.00 - | ATM | 4 | | BKUR6ET-10 | 2397 | 24 | LPG 1 | 1496 |
| Sharan 2 TDI | 1.9 | 85 | 11.05 - | BVK | 4 | █ | Y-741U | 6943 | | D-POWER 20 | 6943 |
| Sharan 2 TDI | 2.0 | 100 | 11.05 - | BVH | 4 | █ | CZ104 | 9826 | | D-POWER 52 | 9826 |
| Sharan 2 TDI | 2.0 | 103 | 11.05 - | BRT | 4 | █ | CZ104 | 9826 | | D-POWER 52 | 9826 |
| Sharan 2 VR6 | 2.8 | 150 | 04.00 - | AYL | 6 | | PZFR5D-11 | 7968 | 34 | LPG 6 | 1565 |
| T 2 | 1.7 | 42 | 10.86 - 08.90 | | 4 | █ | Y-918J | 6285 | | D-POWER 2 | 6285 |
| T 2 D | 1.6 | 37 | 01.81 - 08.90 | CS | 4 | █ | Y-918J | 6285 | | D-POWER 2 | 6285 |
| T 3 | 1.7 | 31 | 10.86 - 07.92 | KY | 4 | █ | Y-918J | 6285 | | D-POWER 2 | 6285 |
| T 4 | 2.0 | 62 | 09.90 - 06.03 | AAC | 4 | | BUR5ET | 3377 | 22 | LPG 2 | 1497 |
| T 4 | 2.4 | 55 | 04.97 - 06.03 | AJA | 5 | █ | Y-918J | 6285 | | D-POWER 2 | 6285 |
| T 4 | 2.5 | 65 | 05.98 - 09.03 | AJT | 5 | █ | Y-732J | 5605 | | D-POWER 4 | 5605 |
| T 4 | 2.5 | 65 | 10.01 - 09.03 | AYY | 5 | █ | Y-732J | 5605 | | D-POWER 4 | 5605 |
| T 4 | 2.5 | 75 | 11.99 - 09.03 | AUF | 5 | █ | Y-732J | 5605 | | D-POWER 4 | 5605 |
| T 4 | 2.5 | 75 | 04.01 - 09.03 | AXL | 5 | █ | Y-732J | 5605 | | D-POWER 4 | 5605 |
| T 4 | 2.5 | 81 | 09.90 - 12.93 | AAF | 5 | | BPR5EKU | 5685 | | LPG 2 | 1497 |
| T 4 | 2.5 | 81 | 08.93 - 10.96 | ACU | 5 | | BUR5ET | 3377 | 22 | LPG 2 | 1497 |
| T 4 | 2.5 | 81 | 05.95 - 12.95 | AEN | 5 | | BUR5ET | 3377 | 22 | LPG 2 | 1497 |
| T 4 | 2.5 | 81 | 08.96 - 09.03 | AET | 5 | | BUR5ET | 3377 | 22 | LPG 2 | 1497 |
| T 4 | 2.5 | 85 | 05.99 - 12.99 | APL | 5 | | BKUR5ET | 2789 | 29 | LPG 1 | 1496 |
| T 4 | 2.5 | 85 | 12.99 - 06.03 | AVT | 5 | | BKUR5ET | 2789 | 29 | LPG 1 | 1496 |
| T 4 | 2.5 | 111 | 07.99 - 09.00 | AHY | 5 | █ | Y-732J | 5605 | | D-POWER 4 | 5605 |
| T 4 | 2.8 | 150 | 05.00 - 09.03 | AMV | 6 | 1,1 | PZFR5D-11 | 7968 | 34 | LPG 6 | 1565 |
| T 4 (China / GUS) | 2.5 | 81 | 08.96 - 06.03 | AEU | 5 | | BUR5ET | 3377 | 22 | LPG 2 | 1497 |
| T 4 D | 1.9 | 44 | 09.90 - 12.95 | 1X | 4 | █ | Y-918J | 6285 | | D-POWER 2 | 6285 |
| T 4 D | 2.4 | 57 | 09.90 - 04.98 | AAB | 5 | █ | Y-918J | 6285 | | D-POWER 2 | 6285 |
| T 4 TD | 1.9 | 50 | 10.92 - 04.02 | ABL | 4 | █ | Y-918J | 6285 | | D-POWER 2 | 6285 |
| T 4 TDI | 2.5 | 75 | 09.95 - 06.03 | ACV | 5 | █ | Y-732J | 5605 | | D-POWER 4 | 5605 |
| T 4 TDI | 2.5 | 75 | 04.01 - 09.03 | AYC | 5 | █ | Y-732J | 5605 | | D-POWER 4 | 5605 |
| T 4 TDI | 2.5 | 111 | 09.00 - 09.03 | AXG | 5 | █ | Y-732J | 5605 | | D-POWER 4 | 5605 |
| T 4 VR6 | 2.8 | 103 | 01.96 - 05.00 | AES | 6 | | BKR5EKUP | 2890 | | | |
| T 4 VR6 (USA) | 2.8 | 150 | 05.00 - 06.03 | AXK | 6 | | PZFR5D-11 | 7968 | 34 | LPG 6 | 1565 |



ℓ kW



Cyl.

Order-
No.VLINE
No.LPG/CNG
D-PowerOrder-
No.**VW**

| | | | | | | | | | | | |
|--------------|-----|-----|-------------|------|----|-----|------------|------|----|------------|------|
| T 5 | 2.0 | 85 | 11.03-05.07 | AXA | 4 | | BKUR6ET-10 | 2397 | 24 | LPG 1 | 1496 |
| T 5 | 2.5 | 120 | 11.03- | BLJ | 5 | █ | Y-741U | 6943 | | D-POWER 20 | 6943 |
| T 5 | 3.2 | 170 | 02.04-05.07 | BDL | 6 | 0,9 | IZKR7B | 7563 | | IZKR7B | 7563 |
| T 5 | 3.2 | 173 | 02.04- | BKK | 6 | 0,9 | IZKR7B | 7563 | | IZKR7B | 7563 |
| T 5 TDI | 1.9 | 62 | 01.06- | BRR | 4 | █ | Y-607AS | 7560 | | D-POWER 50 | 7560 |
| T 5 TDI | 1.9 | 63 | 04.03-05.07 | AXC | 4 | █ | Y-741U | 6943 | | D-POWER 20 | 6943 |
| T 5 TDI | 1.9 | 75 | 01.06- | BRS | 4 | █ | Y-607AS | 7560 | | D-POWER 50 | 7560 |
| T 5 TDI | 1.9 | 77 | 04.03-05.07 | AXB | 4 | █ | Y-741U | 6943 | | D-POWER 20 | 6943 |
| T 5 TDI | 2.0 | 103 | 09.09- | CCHA | 4 | █ | Y1002AS | 8888 | | D-POWER 57 | 8888 |
| T 5 TDI | 2.5 | 96 | 04.03-05.07 | AXD | 5 | █ | Y-741U | 6943 | | D-POWER 20 | 6943 |
| T 5 TDI | 2.5 | 96 | 01.06- | BNZ | 5 | █ | CZ104 | 9826 | | D-POWER 52 | 9826 |
| T 5 TDI | 2.5 | 128 | 04.03-05.07 | AXE | 5 | █ | Y-741U | 6943 | | D-POWER 20 | 6943 |
| T 5 TDI | 2.5 | 128 | 01.06- | BPC | 5 | █ | CZ104 | 9826 | | D-POWER 52 | 9826 |
| Taro | 1.8 | 61 | 02.89-09.94 | 2Y | 4 | 1,1 | BPR5EY-11 | 3028 | | LPG 2 | 1497 |
| Taro | 2.2 | 69 | 06.89-07.94 | 4Y | 4 | 1,1 | BPR5EY-11 | 3028 | | LPG 2 | 1497 |
| Tiguan | 1.4 | 110 | 11.07-11.08 | BWK | 4 | | PZFR6R | 5758 | | PZFR6R | 5758 |
| Tiguan | 1.4 | 110 | 05.08- | CAVA | 4 | | PZFR6R | 5758 | | PZFR6R | 5758 |
| Tiguan | 2.0 | 125 | 01.08- | CAWA | 4 | | PFR7S8EG | 1675 | | | |
| Tiguan | 2.0 | 125 | 11.07- | CCTA | 4 | | PFR7S8EG | 1675 | | | |
| Tiguan | 2.0 | 147 | 11.07-05.10 | CAWB | 4 | | PFR7S8EG | 1675 | | | |
| Tiguan TDI | 2.0 | 81 | 05.10- | CFFD | 4 | █ | Y1002AS | 8888 | | D-POWER 57 | 8888 |
| Tiguan TDI | 2.0 | 100 | 11.07-05.10 | CBAA | 4 | █ | Y-609AS | 5849 | | D-POWER 49 | 5849 |
| Tiguan TDI | 2.0 | 100 | 05.10- | CFFA | 4 | █ | Y1002AS | 8888 | | D-POWER 57 | 8888 |
| Tiguan TDI | 2.0 | 103 | 11.07- | CBAB | 4 | █ | Y-609AS | 5849 | | D-POWER 49 | 5849 |
| Tiguan TDI | 2.0 | 120 | 02.08-05.10 | CBBA | 4 | █ | Y-609AS | 5849 | | D-POWER 49 | 5849 |
| Tiguan TDI | 2.0 | 125 | 02.08-07.09 | CBBB | 4 | █ | Y-609AS | 5849 | | D-POWER 49 | 5849 |
| Touareg | 3.2 | 162 | 11.02-05.04 | AZZ | 6 | 0,9 | IZKR7B | 7563 | | IZKR7B | 7563 |
| Touareg | 3.2 | 162 | 05.03-05.04 | BKJ | 6 | 0,9 | IZKR7B | 7563 | | IZKR7B | 7563 |
| Touareg | 3.2 | 162 | 05.04-11.06 | BMV | 6 | 0,9 | IZKR7B | 7563 | | IZKR7B | 7563 |
| Touareg | 3.2 | 162 | 05.04-11.06 | BMX | 6 | 0,9 | IZKR7B | 7563 | | IZKR7B | 7563 |
| Touareg | 4.2 | 228 | 12.02-11.06 | AXQ | 8 | | BKR6EQUA | 6872 | | LPG 1 | 1496 |
| Touareg | 4.2 | 258 | 12.06- | BAR | 8 | | PFR6W-TG | 5547 | | | |
| Touareg USA | 3.2 | 162 | 08.03-05.04 | BAA | 6 | 0,9 | IZKR7B | 7563 | | IZKR7B | 7563 |
| Touareg FSI | 3.6 | 206 | 10.05- | BHK | 6 | 0,9 | ILZKR7A | 1961 | | ILZKR7A | 1961 |
| Touareg TDI | 2.5 | 120 | 07.03-11.06 | BLK | 5 | █ | Y-741U | 6943 | | D-POWER 20 | 6943 |
| Touareg TDI | 2.5 | 120 | 01.06- | BPD | 5 | █ | CZ104 | 9826 | | D-POWER 52 | 9826 |
| Touareg TDI | 2.5 | 128 | 01.03-11.06 | BAC | 5 | █ | Y-741U | 6943 | | D-POWER 20 | 6943 |
| Touareg TDI | 2.5 | 128 | 01.06- | BPE | 5 | █ | CZ104 | 9826 | | D-POWER 52 | 9826 |
| Touareg TDI | 3.0 | 155 | 04.06-11.07 | BUN | 6 | █ | Y-609AS | 5849 | | D-POWER 49 | 5849 |
| Touareg TDI | 3.0 | 155 | 11.07- | CASB | 6 | █ | Y-609AS | 5849 | | D-POWER 49 | 5849 |
| Touareg TDI | 3.0 | 165 | 11.04-05.08 | BKS | 6 | █ | Y-609AS | 5849 | | D-POWER 49 | 5849 |
| Touareg TDI | 3.0 | 176 | 01.08- | CASC | 6 | █ | Y-609AS | 5849 | | D-POWER 49 | 5849 |
| Touareg TDI | 3.0 | 177 | 11.07- | CASA | 6 | █ | Y-609AS | 5849 | | D-POWER 49 | 5849 |
| Touareg TDI | 5.0 | 230 | 11.04- | BLE | 10 | █ | CZ104 | 9826 | | D-POWER 52 | 9826 |
| Touareg TDI | 5.0 | 230 | 11.02-11.06 | AYH | 10 | █ | Y-741U | 6943 | | D-POWER 20 | 6943 |
| Touareg W12 | 6.0 | 316 | 08.04- | BJN | 12 | 1,1 | PZFR6J-11 | 3586 | | LPG 6 | 1565 |
| Touran | 1.6 | 75 | 07.03-05.05 | BGU | 4 | | BKUR6ET-10 | 2397 | 24 | LPG 1 | 1496 |
| Touran | 1.6 | 75 | 06.05- | BSE | 4 | | BKUR6ET-10 | 2397 | 24 | LPG 1 | 1496 |
| Touran | 1.6 | 75 | 06.05- | BSF | 4 | | BKUR6ET-10 | 2397 | 24 | LPG 1 | 1496 |
| Touran | 2.0 | 80 | 02.06- | BSX | 4 | 0,9 | BKR6E | 6962 | 28 | LPG 1 | 1496 |
| Touran China | 2.0 | 85 | 04- | BJZ | 4 | | ZFR5P-G | 6893 | | LPG 6 | 1565 |
| Touran China | 1.8 | 110 | 04- | BPL | 4 | | PFR6Q | 6458 | 37 | LPG 1 | 1496 |



ℓ kW



Cyl.

Order-
No. No.LPG/CNG
D-PowerOrder-
No.**VW**

| | | | | | | | | | | | |
|------------------------|-----|-----|---------------|-----------|---|-----|------------|------|----|------------|------|
| Touran FSI | 1.4 | 103 | 02.06 - | BMY | 4 | 0,9 | PZFR6R | 5758 | | PZFR6R | 5758 |
| Touran FSI | 1.4 | 125 | 11.06 - 11.08 | BLG | 4 | 0,9 | PZFR6R | 5758 | | PZFR6R | 5758 |
| Touran FSI | 1.6 | 85 | 02.03 - 05.04 | BAG | 4 | | ZFR6S-Q | 6449 | | ZFR6S-Q | 6449 |
| Touran FSI | 1.6 | 85 | 02.05 - 01.07 | BLF | 4 | | ZFR6S-Q | 6449 | | ZFR6S-Q | 6449 |
| Touran FSI | 1.6 | 85 | 05.04 - 05.05 | BLP | 4 | | ZFR6S-Q | 6449 | | ZFR6S-Q | 6449 |
| Touran FSI | 2.0 | 110 | 10.03 - 05.04 | AXW | 4 | | PZFR5N-11T | 7742 | | PZFR5N-11T | 7742 |
| Touran FSI | 2.0 | 110 | 10.03 - 01.04 | BHD | 4 | | PZFR5N-11T | 7742 | | PZFR5N-11T | 7742 |
| Touran FSI | 2.0 | 110 | 02.05 - 11.05 | BLR | 4 | | PZFR5N-11T | 7742 | | PZFR5N-11T | 7742 |
| Touran FSI | 2.0 | 110 | 05.04 - 11.05 | BLX | 4 | | PZFR5N-11T | 7742 | | PZFR5N-11T | 7742 |
| Touran FSI | 2.0 | 110 | 05.04 - 11.05 | BLY | 4 | 0,9 | BKR6E | 6962 | 28 | LPG 1 | 1496 |
| Touran FSI | 2.0 | 110 | 11.05 - 01.07 | BVY | 4 | | PZFR5N-11T | 7742 | | PZFR5N-11T | 7742 |
| Touran FSI | 2.0 | 110 | 11.05 - 01.07 | BVZ | 4 | 0,9 | BKR6E | 6962 | 28 | LPG 1 | 1496 |
| Touran TDI | 1.9 | 66 | 11.04 - 02.06 | BRU | 4 | █ | Y-607AS | 7560 | | D-POWER 50 | 7560 |
| Touran TDI | 1.9 | 66 | 02.06 - | BXF | 4 | █ | Y-607AS | 7560 | | D-POWER 50 | 7560 |
| Touran TDI | 1.9 | 66 | 06.06 - | BXJ | 4 | █ | Y-607AS | 7560 | | D-POWER 50 | 7560 |
| Touran TDI | 1.9 | 74 | 02.03 - 05.04 | AVQ | 4 | █ | Y-607AS | 7560 | | D-POWER 50 | 7560 |
| Touran TDI | 1.9 | 77 | 08.03 - 02.06 | BKC | 4 | █ | Y-607AS | 7560 | | D-POWER 50 | 7560 |
| Touran TDI | 1.9 | 77 | 06.05 - | BLS | 4 | █ | Y-607AS | 7560 | | D-POWER 50 | 7560 |
| Touran TDI | 1.9 | 77 | 02.06 - | BXE | 4 | █ | Y-607AS | 7560 | | D-POWER 50 | 7560 |
| Touran TDI | 2.0 | 103 | 08.03 - | BKD | 4 | █ | YE14 | 7768 | | D-POWER 48 | 7768 |
| Touran TDI | 2.0 | 103 | 12.05 - | BMM | 4 | █ | Y-607AS | 7560 | | D-POWER 50 | 7560 |
| Touran TDI | 2.0 | 103 | 05.10 - | CFHC | 4 | █ | Y1002AS | 8888 | | D-POWER 57 | 8888 |
| Touran TDI | 2.0 | 125 | 12.05 - | BMN | 4 | █ | CZ304 | 9864 | | D-POWER 55 | 9864 |
| Touran TDI 16V | 2.0 | 100 | 02.03 - | AZV | 4 | █ | YE14 | 7768 | | D-POWER 48 | 7768 |
| Touran TSI | 1.4 | 103 | 11.08 - | CAVC | 4 | 0,9 | PZFR6R | 5758 | | PZFR6R | 5758 |
| Touran TSI | 1.4 | 125 | 11.08 - | CAVB | 4 | 0,9 | PZFR6R | 5758 | | PZFR6R | 5758 |
| Transporter | 1.6 | 34 | 05.80 - 12.82 | CZ002828- | 4 | 0,7 | B6ES | 7310 | | | |
| Transporter | 1.6 | 37 | 05.80 - 12.82 | CT065011- | 4 | 0,6 | B6ES | 7310 | | | |
| Transporter | 1.8 | 49 | 09.90 - 07.92 | PD | 4 | | BUR6ET | 3172 | 1 | LPG 2 | 1497 |
| Transporter | 1.9 | 44 | 08.82 - 08.87 | DF | 4 | | BUR6ET | 3172 | 1 | LPG 2 | 1497 |
| Transporter | 1.9 | 44 | 08.87 - 07.89 | DF | 4 | 0,7 | BP6ESZ | 7639 | | LPG 2 | 1497 |
| Transporter | 1.9 | 44 | 08.89 - 07.92 | DF | 4 | | BUR6ET | 3172 | 1 | LPG 2 | 1497 |
| Transporter | 1.9 | 54 | 08.82 - 08.87 | SP | 4 | | BUR6ET | 3172 | 1 | LPG 2 | 1497 |
| Transporter | 1.9 | 54 | 08.87 - 07.89 | SP | 4 | 0,7 | BP6ESZ | 7639 | | LPG 2 | 1497 |
| Transporter | 1.9 | 57 | 08.82 - 07.92 | DG | 4 | | BUR6ET | 3172 | 1 | LPG 2 | 1497 |
| Transporter | 1.9 | 60 | 07.83 - 07.85 | | 4 | 0,7 | B6ES | 7310 | | | |
| Transporter | 1.9 | 66 | 08.83 - 07.85 | GW | 4 | 0,7 | B6ES | 7310 | | | |
| Transporter | 2.1 | 64 | 08.86 - 07.92 | SR | 4 | 0,7 | B6ES | 7310 | | | |
| Transporter | 2.1 | 68 | 08.85 - 07.92 | SS | 4 | 0,7 | B6ES | 7310 | | | |
| Transporter | 2.1 | 70 | 08.85 - 07.92 | MV | 4 | 0,7 | B6ES | 7310 | | | |
| Transporter | 2.1 | 82 | 08.84 - 07.92 | DJ | 4 | | BUR6ET | 3172 | 1 | LPG 2 | 1497 |
| Transporter TDI | 2.0 | 132 | 09.09 - | CFCA | 4 | █ | Y1002AS | 8888 | | D-POWER 57 | 8888 |
| Transporter TDI | 2.0 | 103 | 09.09 - | CAAC | 4 | █ | Y1002AS | 8888 | | D-POWER 57 | 8888 |
| Transporter TDI | 2.0 | 103 | 09.09 - | CCHA | 4 | █ | Y1002AS | 8888 | | D-POWER 57 | 8888 |
| Transporter TDI | 2.0 | 132 | 09.09 - | CFCA | 4 | █ | Y1002AS | 8888 | | D-POWER 57 | 8888 |
| Transporter TDI | 2.0 | 62 | 09.09 - | CAAA | 4 | █ | Y1002AS | 8888 | | D-POWER 57 | 8888 |
| Transporter TDI | 2.0 | 75 | 09.09 - | CAAB | 4 | █ | Y1002AS | 8888 | | D-POWER 57 | 8888 |
| Transporter 2 (MEXICO) | 1.8 | 63 | 01.93 - | ACB | 4 | 0,8 | BP5ES | 6511 | 8 | LPG 2 | 1497 |
| Vento D | 1.9 | 47 | 01.92 - 12.97 | 1Y | 4 | █ | Y-918J | 6285 | | D-POWER 2 | 6285 |
| Vento SDI | 1.9 | 47 | 07.95 - 12.97 | AEY | 4 | █ | Y-732J | 5605 | | D-POWER 4 | 5605 |
| Vento TD | 1.9 | 55 | 01.92 - 12.97 | AAZ | 4 | █ | Y-918J | 6285 | | D-POWER 2 | 6285 |
| Vento TDI | 1.9 | 66 | 07.93 - 07.96 | 1Z | 4 | █ | Y-732J | 5605 | | D-POWER 4 | 5605 |



ℓ kW

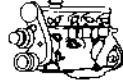

Cyl.

Order-
No. No.LPG/CNG
D-PowerOrder-
No.**VW**

| | | | | | | | | | | | |
|-----------|-----|----|---------------|-----|---|---|--------|------|--|-----------|------|
| Vento TDI | 1.9 | 66 | 08.96 - 12.97 | AHU | 4 | █ | Y-732J | 5605 | | D-POWER 4 | 5605 |
| Vento TDI | 1.9 | 81 | 02.96 - 12.97 | AFN | 4 | █ | Y-732J | 5605 | | D-POWER 4 | 5605 |

WARTBURG AWE

| | | | | | | | | | | | |
|-----|-----|----|---------------|----|---|-----|-------|------|---|-------|------|
| 1.3 | 1.3 | 43 | 09.88 - 05.91 | VW | 4 | 0,7 | BP6ES | 7811 | 4 | LPG 2 | 1497 |
|-----|-----|----|---------------|----|---|-----|-------|------|---|-------|------|

WIESMANN

| | | | | | | | | | | | |
|----------------|-----|-----|------------|---------|----|-----|----------|------|----|----------|------|
| Coupè GT MF4 | 4.4 | 245 | 05 - 05 | N62 B44 | 8 | | BKR6EQU | 3199 | 30 | LPG 1 | 1496 |
| Coupè GT MF4 | 4.8 | 270 | 09.05 - | N62 B48 | 8 | 1,1 | IZFR6H11 | 4294 | | IZFR6H11 | 4294 |
| Coupè GT MF5 | 5.0 | 373 | 07 - | S85 B50 | 10 | | LKR8AP | 4471 | | LKR8AP | 4471 |
| Roadster MF4-S | 4.0 | 309 | 03.09 - | S65 B40 | 8 | | LKR8AP | 4471 | | LKR8AP | 4471 |
| Roadster MF28 | 2.8 | 142 | 95 - | M52 B28 | 6 | | BKR6EK | 2288 | 20 | LPG 1 | 1496 |
| Roadster MF3 | 3.2 | 236 | 95 - 11.01 | S50 B32 | 6 | 0,7 | PKR7A | 3641 | | PKR7A | 3641 |
| Roadster MF3 | 3.2 | 252 | 12.01 - | S54 B32 | 6 | | DCPR8EKP | 7415 | | | |

YUGO

| | | | | | | | | | | | |
|-----------------------|--|--|---------|--|---|-----|--------|------|---|-------|------|
| Florida 1.4, 1.5, 1.6 | | | - 12.93 | | 4 | 0,6 | BPR6ES | 7822 | 2 | LPG 2 | 1497 |
|-----------------------|--|--|---------|--|---|-----|--------|------|---|-------|------|

Z.A.Z.

| | | | | | | | | | | | |
|--------------|-----|----|---------|--|---|-----|-------|------|----|---------|------|
| 1102 Tawrija | 1.1 | 37 | 06.90 - | | 4 | 0,7 | BP6ES | 7811 | 4 | LPG 2 | 1497 |
| 1102 Tawrija | 1.3 | 44 | 06.90 - | | 4 | 0,7 | BP6ES | 7811 | 4 | LPG 2 | 1497 |
| 968 | 1.2 | 29 | 81 - 90 | | 4 | 0,6 | BP6HS | 4511 | 18 | BPR7HIX | 5944 |
| Megane kombi | 1.1 | 37 | 06.90 - | | 4 | 0,7 | BP6ES | 7811 | 4 | LPG 2 | 1497 |

ZASTAVA

| | | | | | | | | | | | |
|-------------|-----|----|---------------|--|---|-----|--------|------|---|-------|------|
| 45 | | | 01.82 - | | 4 | 0,7 | BP6ES | 7811 | 4 | LPG 2 | 1497 |
| 55 | | | 82 - | | 4 | 0,7 | BP6ES | 7811 | 4 | LPG 2 | 1497 |
| 60 | | | 82 - | | 4 | 0,7 | BP6ES | 7811 | 4 | LPG 2 | 1497 |
| 65 | | | 82 - | | 4 | 0,7 | BP6ES | 7811 | 4 | LPG 2 | 1497 |
| 65 EFI | 1.3 | | 89 - | | 4 | 0,8 | BPR6ES | 7822 | 2 | LPG 2 | 1497 |
| Florida | 1.4 | 48 | 07.89 - 12.93 | | 4 | 0,8 | BPR6ES | 7822 | 2 | LPG 2 | 1497 |
| Florida | 1.6 | 62 | 07.89 - 12.93 | | 4 | 0,8 | BPR6ES | 7822 | 2 | LPG 2 | 1497 |
| Florida EFI | 1.4 | 53 | 10.88 - 12.93 | | 4 | 0,8 | BPR6ES | 7822 | 2 | LPG 2 | 1497 |
| Sana | 1.4 | 53 | 89 - | | 4 | 0,8 | BPR6ES | 7822 | 2 | LPG 2 | 1497 |

Conversion Chart

Vergleichsliste

Tableau de comparaison thermique

Tabla de conversión equivalencias

Jämförelsetabell

Převodní tabulky

Note: This chart is furnished as a guide. Due to differences in design, materials, etc., plugs produced by various manufacturers do not have exactly the same heat range. See recommendations sections for specific engine application.

Anmerkung: Diese Liste dient nur zur Information. Wegen der Unterschiede von Konstruktion, Werkstoffen usw. haben die Zündkerzen von verschiedenen Herstellern keinen miteinander übereinstimmenden Wärmebereich. Siehe unsere Empfehlungen für die richtige Anwendung der Zündkerzen.

Notes: Cette liste est donnée comme guide. A cause de la différence en dessin, matériels etc., les bougies d'allumage produites par divers fabricans n'ont pas exactement la même gamme thermique. Voir section d'affectations pour utilisation exacte.

Notas: Este cuadro se sirve de guía. Bujías que se producen por varios fabricantes no poseen exactamente el mismo alcance térmico debido a las diferencias en diseño, materiales etc. Véase sección de aplicaciones para el uso correcto.

Observera: Denna tabell är endast avsedd som vägledning. På grund av avvikelser i utförande, material m.m. kan tändstift av olika fabrikat ej ha exakt samma värmetal. Se rekommendations-tabellen för respektive motor.

Upozornění: Převodní tabulky slouží pouze pro srovnávací účely. Zapalovací svíčky od různých výrobců nemají kvůli rozdílné konstrukci, použitému materiálu apod. srovnatelný rozsah tepelných hodnot. Pro správný výběr zapalovací svíčky je třeba se řídit doporučeními firmy NGK v aplikačních tabulkách tohoto katalogu.



| AC | → NGK Typ | V-LINE |
|-----------|------------------|---------------|
| 40TS | BP7FS | |
| 41-100 | IZTR4A11 | |
| 41-101 | ITR4A15 | |
| 41-103 | ILTR5B11 | |
| 41-105 | ILTR5C11 | |
| 41-107 | ILTR6B11 | |
| 412XLS | BP7ES | |
| 414XLS | BP6ES | V-Line No. 4 |
| 41-600 | TR55IX | |
| 41-601 | BPR6ES | V-Line No. 2 |
| 41-602 | FR5 | |
| 41-603 | FR4 | |
| 41-606 | TR55 | |
| 41-608 | FR45 | |
| 41-610 | FR4 | |
| 41-611 | FR45 | |
| 41-627 | BKR4E-11 | |
| 41-628 | FR4 | |
| 41-900 | TR5 | |
| 41-902 | TR55 | |
| 41-904 | TR5 | |
| 41-905 | UR4 | |
| 41-906 | TR5 | |
| 41-907 | TR5 | |
| 41-910 | TR5 | |
| 41-913 | TR55 | |
| 41-919 | TR55 | |
| 41-921 | TR55 | |
| 41-928 | TR55-1 | |
| 41-929 | TR55 | |
| 41-932 | TR55 | |
| 41-933 | PTR4B-15 | |
| 41-936 | TR55 | |
| 41-940 | TR55 | |
| 41-942 | TR55 | |
| 41-943 | TR55 | |
| 41-947 | TR55 | |
| 41-948 | TR4IX | |
| 41-950 | PTR5C-13 | |
| 41-963 | PTR5C-13 | |
| 41-974 | PZTR5A-15 | |
| 41-983 | PZTR5A-15 | |
| 41-985 | IZTR5B11 | |
| 41-987 | PTR5C-13 | |
| 41-988 | LTR6AP-11 | |
| 41-993 | PTR4G-15 | |
| 41TS | BP6FS | |
| 41XLS | BP7ES | |
| 422Z | B5HS | |
| 426FS | BP6HS | V-Line No. 18 |
| 42FS | BP6HS | V-Line No. 18 |
| 42TS | BP6FS | |

| AC | → NGK Typ | V-LINE |
|-----------|------------------|---------------|
| 42XLS | BP6ES | V-Line No. 4 |
| 436XLS | BP9ES | |
| 438XLS | BP8ES | |
| 43FFS | BP6HS | V-Line No. 18 |
| 43FS | BP6HS | V-Line No. 18 |
| 43TS | BP6FS | |
| 43XLS | BP6ES | V-Line No. 4 |
| 440T | B7FS | |
| 440XLS | BP8ES | |
| 44F | B5HS | |
| 44FF | B5HS | |
| 44FFS | BP5HS | |
| 44NS | BP5ES | V-Line No. 8 |
| 44TS | BP5FS | |
| 44XLO | BP5ES | V-Line No. 8 |
| 44XLS | BP5ES | V-Line No. 8 |
| 45F | B5HS | |
| 45FF | B5HS | |
| 45FFS | BP5HS | |
| 45NS | BP5ES | V-Line No. 8 |
| 45TS | BP4FS | |
| 45XLS | BP5ES | V-Line No. 8 |
| 46F | B5HS | |
| 46FF | B5HS | |
| 46FFS | BP5HS | |
| 46TS | BP4FS | |
| 83CTS | AP6FS | |
| 83TS | AP6FS | |
| 84T | A6FS | |
| 84TS | AP5FS | |
| 85TS | AP5FS | |
| 86TS | AP5FS | |
| B44FS | BP5HS | |
| C42CFS | BP6HS | V-Line No. 18 |
| C42CLTS | BP6EFS | V-Line No. 5 |
| C42CXLS | BP6ES | V-Line No. 4 |
| C42LTS | BP6EFS | V-Line No. 5 |
| C42XLS | BP5ES | V-Line No. 8 |
| C43CXLS | BP6ES | V-Line No. 4 |
| C44NS | BP5ES | V-Line No. 8 |
| C82T | A7FS | |
| C83T | A6FS | |
| C84T | A6FS | |
| C85TS | AP5FS | |
| CFR1CLS | BCPR7ES | |
| CFR2CLS | BKR6ES | V-Line No. 28 |
| CR42CFS | BPR6FS | |
| CR42CXLS | BPR6ES | V-Line No. 2 |
| CR43CXLS | BPR6ES | V-Line No. 2 |
| CR43N | BR6ES | |
| CR43TS | BPR5FS-11 | |
| CR43TSM | BPR5FS-11 | |



| AC | → NGK Typ | V-LINE |
|-----------|------------------|---------------|
| CR44N | BR6ES | |
| CR44NS | BPR5ES | V-Line No. 6 |
| CR44TS | BPR5FS-11 | |
| CR45TS | UR4 | |
| CR83T | AR6FS | |
| FR2LS | BKR6ES | V-Line No. 28 |
| FR2LSK | BKR6ES | V-Line No. 28 |
| FR3CLS | BKR5ES | V-Line No. 35 |
| FR3CLS6 | BKR5ES-11 | V-Line No. 33 |
| FR3LM | ZFR5A-11 | |
| FR3LS | BKR5ES | V-Line No. 35 |
| FR3LS6 | BKR5ES-11 | V-Line No. 33 |
| FR3LSJ | BKR4E-11 | |
| FR3LSK | BKR5ES | V-Line No. 35 |
| FR4LE | ZFR4F-11 | |
| FR4LSJ | BKR4E-11 | |
| FR5LS | BKR5ES | V-Line No. 35 |
| M45FF | B5HS | |
| M90 | B9S | |
| MR42LTS | BPR6EFS | V-Line No. 7 |
| MR43LTS | BPR6EFS | V-Line No. 7 |
| MR44T | BR5FS | |
| R415TS | BPR6FS | |
| R41CXLS | BPR7ES | V-Line No. 19 |
| R41TS | BPR6FS | |
| R425LTS | BPR6EFS | V-Line No. 7 |
| R425TS | BPR6FS | |
| R426FS | BPR6HS | V-Line No. 3 |
| R42CFS | BPR6HS | V-Line No. 3 |
| R42CLTS | BPR6EFS | V-Line No. 7 |
| R42CTS | BPR6FS | |
| R42CXLS | BPR6ES | V-Line No. 2 |
| R42FS | BPR6HS | V-Line No. 3 |
| R42LTS | BPR6EFS | V-Line No. 7 |
| R42LTSM | BPR5EFS-13 | |
| R42TS | BPR6FS | |
| R42TSM | BPR6FS | |
| R42XLS | BPR6ES | V-Line No. 2 |
| R42XLSM | ZGR5C | |
| R43CFS | BPR6HS | V-Line No. 3 |
| R43CNTSE | TR5-1 | |
| R43CTS | BPR6FS | |
| R43CTS6 | BPR6FS | |
| R43CXLS | BPR6ES | V-Line No. 2 |
| R43FS | BPR6HS | V-Line No. 3 |
| R43LTS | BPR6EFS | V-Line No. 7 |
| R43LTSE | TR4 | |
| R43LTSX | BPR6EFS-13 | |
| R43NTSE | TR5-1 | |
| R43TS | BPR6FS | |
| R43TSK | BPR6FS | |
| R43TSX | BPR6FS | |

| AC | → NGK Typ | V-LINE |
|-----------|------------------|---------------|
| R43XLS | BPR6ES | V-Line No. 2 |
| R44CNTSE | TR5-1 | |
| R44CXL | BR6ES | |
| R44CXLS | BPR5ES | V-Line No. 6 |
| R44LTS | BPR5EFS | |
| R44LTS6 | BPR5EFS-13 | |
| R44LTS6K | BPR5EFS-13 | |
| R44LTSM | TR4 | |
| R44LTSM6 | TR4 | |
| R44N | BR6ES | |
| R44NS | BPR5ES | V-Line No. 6 |
| R44NTSE | TR5-1 | |
| R44T | BR5FS | |
| R44TS | BPR5FS | |
| R44TSX | BPR5FS-15 | |
| R44TX | BR5FS | |
| R44XL | BR6ES | |
| R44XLS | BPR5ES | V-Line No. 6 |
| R44XLS6 | BPR4ES-13 | |
| R44XLSE | ZGR5C | |
| R44XLSM | ZGR5C | |
| R45LTS6 | BPR5EFS-13 | |
| R45LTS6K | BPR5EFS-13 | |
| R45NS | BPR5ES | V-Line No. 6 |
| R45NSX | BPR5ES-13 | |
| R45NTSE | TR5-1 | |
| R45T | BR5FS | |
| R45TS | BPR4FS | |
| R45TSX | BPR4FS-15 | |
| R45XL | BR6ES | |
| R45XLS | BPR5ES | V-Line No. 6 |
| R46LTS | BPR5EFS | |
| R46N | BR5ES | |
| R46SZ | XR45IX | |
| R46T | BR5FS | |
| R46TS | BPR4FS | |
| R46TSX | BPR4FS-15 | |
| R46TX | BR5FS | |
| R46XL | BR5ES | |
| R46XLS | BPR4ES | |
| R83CT | AR6FS | |
| R83CTS | APR6FS | |
| R83TS | APR6FS | |
| R84TS | APR5FS | |
| R85TS | APR5FS | |
| S40FR | BR9HS | |
| S40XLG | B9ECS | |
| S41XLG | B8ECS | |
| S44F | B5HS | |
| S45F | B5HS | |
| V40 | B9S | |



ALFA ROMEO => siehe FIAT Group

AMG => siehe MERCEDES

ASTON MARTIN → NGK Typ V-LINE
723116 BCPR6E V-Line No. 12

AUDI => siehe VW Group

AUTOLITE / TUNER → NGK Typ V-LINE

| | | |
|------|-----------|---------------|
| 102 | BP7EFS | |
| 103 | BPR6EFS | V-Line No. 7 |
| 104 | BPR6EFS | V-Line No. 7 |
| 105 | BPR5EFS | |
| 106 | BPR5EFS | |
| 112 | A9FS | |
| 113 | A7FS | |
| 115 | A6FS | |
| 117 | A6FS | |
| 12 | BP7FS | |
| 124 | AR6FS | |
| 13 | BP6FS | |
| 135 | B7FS | |
| 14 | BP6FS | |
| 146 | BR5FS | |
| 147 | BR5FS | |
| 15 | BP5FS | |
| 156 | AP5FS | |
| 16 | BP4FS | |
| 166 | APR5FS | |
| 203 | BPR6FS | |
| 23 | BPR6FS | |
| 24 | BPR6FS | |
| 2413 | B10EGP | |
| 2417 | B7ECS | |
| 25 | BPR5FS | |
| 2543 | TR5-1 | |
| 2544 | TR5-1 | |
| 2545 | TR5-1 | |
| 2546 | TR5-1 | |
| 2585 | BPR5ES | V-Line No. 6 |
| 26 | BPR4FS-15 | |
| 2656 | B5HS | |
| 27 | BPR4FS-15 | |
| 273 | BP6HS | V-Line No. 18 |
| 274 | BP6HS | V-Line No. 18 |
| 275 | BP5HS | |
| 276 | BP5HS | |
| 284 | BPR6HS | V-Line No. 3 |
| 3036 | BPR4FS-15 | |
| 3055 | A6FS | |
| 32 | AP7FS | |
| 3203 | BPR6ES | V-Line No. 2 |

AUTOLITE / TUNER → NGK Typ V-LINE

| | | |
|------|-----------|---------------|
| 3204 | BPR6ES | V-Line No. 2 |
| 3205 | BPR5ES | V-Line No. 6 |
| 3206 | BPR5ES | V-Line No. 6 |
| 3207 | BPR5ES | V-Line No. 6 |
| 3243 | BPR6EFS | V-Line No. 7 |
| 3244 | BPR6EFS | V-Line No. 7 |
| 3245 | BPR5EFS | |
| 3246 | BPR5EFS | |
| 3264 | B7FS | |
| 3266 | BR5FS | |
| 3267 | BR5FS | |
| 3286 | APR6FS | |
| 33 | AP6FS | |
| 3303 | BPR6FS | |
| 3364 | BPR6HS | V-Line No. 3 |
| 34 | AP6FS | |
| 3404 | AR6FS | |
| 344 | AR6FS | |
| 3463 | BR6ES | |
| 3464 | BR6ES | |
| 3465 | BR5ES | |
| 3466 | BR5ES | |
| 35 | AP5FS | |
| 3565 | BPR5EFS | |
| 3586 | BPR5ES-13 | |
| 36 | AP5FS | |
| 3604 | BPR5FS-15 | |
| 3605 | BPR4FS-15 | |
| 3606 | BPR4FS-15 | |
| 3607 | BPR4FS-15 | |
| 3627 | BR5FS | |
| 37 | AP5FS | |
| 3705 | BR6ES | |
| 3706 | BR6ES | |
| 3724 | BPR5EFS | |
| 3885 | ZGR5C | |
| 3896 | ZGR5C | |
| 3922 | BCPR7ES | |
| 3924 | BKR6ES | V-Line No. 28 |
| 3926 | BKR5ES | V-Line No. 35 |
| 3985 | BPR5FS-15 | |
| 403 | BR6ES | |
| 404 | BR6ES | |
| 4043 | BPR6ES-11 | V-Line No. 13 |
| 405 | BR5ES | |
| 406 | BR5ES | |
| 4113 | BP6HS | V-Line No. 18 |
| 4114 | BP6HS | V-Line No. 18 |
| 4123 | BPR6HS | V-Line No. 3 |
| 415 | B5HS | |
| 416 | B5HS | |
| 4251 | BP8ES | |



| AUTOLITE / TUNER → NGK Typ | V-LINE |
|-----------------------------------|----------------------|
| 4252 | BP7ES |
| 4253 | BP6ES V-Line No. 4 |
| 4263 | BPR6ES V-Line No. 2 |
| 4265 | BPR5ES V-Line No. 6 |
| 43 | APR6FS |
| 44 | APR6FS |
| 45 | APR5FS |
| 46 | APR5FS |
| 472 | B9EFS |
| 483 | BR7EFS |
| 5143 | TR5-1 |
| 515 | BP5HS |
| 516 | BP5HS |
| 52 | BP7ES |
| 5224 | BKR5E V-Line No. 35 |
| 53 | BP6ES V-Line No. 4 |
| 535 | B5HS |
| 54 | BP6ES V-Line No. 4 |
| 55 | BP5ES V-Line No. 8 |
| 56 | BP5ES V-Line No. 8 |
| 584 | AR6FS |
| 603 | BPR6EFS-13 |
| 604 | BPR6EFS-13 |
| 605 | BPR6EFS-13 |
| 62 | BP7ES |
| 63 | BPR6ES V-Line No. 2 |
| 64 | BPR6ES V-Line No. 2 |
| 646 | BPR5ES-13 |
| 65 | BPR5ES V-Line No. 6 |
| 66 | BPR5ES V-Line No. 6 |
| 664 | BPR6FS |
| 665 | BPR5FS-15 |
| 666 | BPR4FS-15 |
| 667 | BPR4FS-15 |
| 67 | BPR4ES |
| 687 | BR5FS |
| 723 | BPR6FS |
| 724 | BPR6FS |
| 725 | BPR5FS-11 |
| 726 | BPR4FS |
| 727 | BPR4FS-11 |
| 744 | APR5FS |
| 746 | APR5FS |
| 747 | APR5FS |
| 763 | TR5-1 |
| 764 | BPR6EFS V-Line No. 7 |
| 765 | BPR5EFS |
| 766 | BPR5EFS |
| 784 | AR6FS |
| 804 | AR6FS |
| 865 | BPR5EFS |
| 884 | BPR6EFS-13 |

| AUTOLITE / TUNER → NGK Typ | V-LINE |
|-------------------------------------|--------------------------|
| 9062 | BP6ET V-Line No. 1 |
| 9063 | BP6ET V-Line No. 1 |
| 9064 | BP5ET |
| 915 | ZGR5C |
| 925 | ZGR5C |
| 935 | BPR5ES V-Line No. 6 |
| 94 | BP7EFS |
| 945 | BPR5ES V-Line No. 6 |
| 985 | ZFR4F-11 |
| 9921 | BCPR6ET |
| AP63 | PFR6B |
| APP392411 | BKR5EP-11 |
| BENTLEY => siehe VW Group | |
| BERU → NGK Typ | V-LINE |
| 0001325701 | BP5ES V-Line No. 8 |
| 0001325704 | BP5ESZ |
| 0001325705 | BCP5ES V-Line No. 16 |
| 0001325710 | BP5ET |
| 0001330104 | BUR5ET V-Line No. 22 |
| 0001330112 | BUR5ET-10 V-Line No. 21 |
| 0001330113 | BUR5ET V-Line No. 22 |
| 0001330116 | BKUR5ET-10 |
| 0001330119 | BKUR5ET V-Line No. 29 |
| 0001330501 | BKR6EK V-Line No. 20 |
| 0001330702 | BP5ES V-Line No. 8 |
| 0001330707 | BCP5ES V-Line No. 16 |
| 0001330709 | BP5ET-10 |
| 0001330713 | BP5ESZ |
| 0001330717 | ZFR5F |
| 0001330718 | ZGR5A V-Line No. 15 |
| 0001330725 | BCP5ES V-Line No. 16 |
| 0001330726 | BP5ESZ |
| 0001330731 | BCP5ES V-Line No. 16 |
| 0001330780 | BKR6EZB |
| 0001330904 | IFR5D10 |
| 0001335107 | BKUR6ET-10 V-Line No. 24 |
| 0001335108 | BUR6ET V-Line No. 1 |
| 0001335702 | BP6ES V-Line No. 4 |
| 0001335709 | BP6ET V-Line No. 1 |
| 0001335714 | BP6ESZ |
| 0001335721 | BCP6ES V-Line No. 17 |
| 0001335725 | BCP6ES V-Line No. 17 |
| 0001335729 | BKR6ES V-Line No. 28 |
| 0001335732 | BKR6EK V-Line No. 20 |
| 0001335737 | BP6ESZ |
| 0001335742 | ZFR5P-G |
| 0001335905 | IFR6D10 |
| 0001335910 | IFR6D10 |
| 0001335911 | PZFR5D-11 V-Line No. 34 |
| 0001335914 | PFR6Q V-Line No. 37 |



| BERU | → NGK Typ | V-LINE |
|-------------|------------------|---------------|
| 0001340103 | BKUR6ET | V-Line No. 27 |
| 0001340702 | BP6ES | V-Line No. 4 |
| 0001340704 | BP6ET | V-Line No. 1 |
| 0001340706 | BCP6ET | |
| 0001340707 | BP6ESZ | |
| 0001340716 | BCP6ES | V-Line No. 17 |
| 0001340717 | BCP6ET | |
| 0001340723 | BKR6ES | V-Line No. 28 |
| 0001340806 | BKR6ES | V-Line No. 28 |
| 0001340903 | BP6ES | V-Line No. 4 |
| 0001340908 | PFR7Q | |
| 0001345702 | BP7ES | |
| 0001345704 | BP6ET | V-Line No. 1 |
| 0001345711 | BP7ES | |
| 0001345720 | BCP7ES | |
| 0001350903 | BP7ES | |
| 0001430700 | BP5HS | |
| 0001430701 | B5HS | |
| 0001435700 | BP6HS | V-Line No. 18 |
| 0001440700 | BP6HS | V-Line No. 18 |
| 0001445700 | BP7HS | |
| 0001625700 | BP5EFS | |
| 0001625702 | BP5EFS | |
| 0001630700 | BP5EFS | |
| 0001630704 | BP5EFS | |
| 0001635700 | BP6EFS | V-Line No. 5 |
| 0001635709 | BP6EFS | V-Line No. 5 |
| 0001640700 | BP6EFS | V-Line No. 5 |
| 0001640704 | BP6EFS | V-Line No. 5 |
| 0001640705 | BP6EFS | V-Line No. 5 |
| 0001645700 | BP7EFS | |
| 0001645703 | BP7EFS | |
| 0001735700 | AP6FS | |
| 0001740700 | AP6FS | |
| 0002235901 | PLZKBR7A-G | |
| 0002325700 | BPR5ES | V-Line No. 6 |
| 0002330204 | BKR5EYA-11 | V-Line No. 39 |
| 0002330701 | BPR5ES | V-Line No. 6 |
| 0002330702 | BPR5ES-11 | |
| 0002330703 | BKR5ES | V-Line No. 35 |
| 0002330704 | BKR5ES-11 | V-Line No. 33 |
| 0002330706 | BPR5EKU | |
| 0002330710 | BKR5EK | V-Line No. 23 |
| 0002330712 | BCRE527Y | |
| 0002330713 | BKR5EY | |
| 0002330714 | BKR5EYA | |
| 0002335100 | BCPR7ET | |
| 0002335500 | BKR6EK | V-Line No. 20 |
| 0002335701 | BPR6ES | V-Line No. 2 |
| 0002335704 | BR6ES | |
| 0002335706 | BPR6ES-11 | V-Line No. 13 |
| 0002335707 | BKR6ES | V-Line No. 28 |

| BERU | → NGK Typ | V-LINE |
|-------------|------------------|---------------|
| 0002335708 | BKR6ES-11 | V-Line No. 14 |
| 0002335712 | BKR6EY | |
| 0002335713 | BKR6EYA | |
| 0002335714 | BKR6EYA-11 | |
| 0002335715 | ZFR6F-11 | |
| 0002335719 | LFR6B | |
| 0002335902 | BCPR6EP-11 | |
| 0002335903 | BCPR6EP-11 | |
| 0002335904 | BKR6EP-8 | |
| 0002335911 | BKR6EQUP | V-Line No. 30 |
| 0002340102 | BKR6EKUB | |
| 0002340500 | BKR6EK | V-Line No. 20 |
| 0002340501 | BKR6EKE | |
| 0002340504 | BKR6EKC | V-Line No. 26 |
| 0002340701 | BPR6ES | V-Line No. 2 |
| 0002340702 | BKR6ES | V-Line No. 28 |
| 0002340703 | BPR6ES-11 | V-Line No. 13 |
| 0002340704 | BKR6ES-11 | V-Line No. 14 |
| 0002345701 | BPR7ES | V-Line No. 19 |
| 0002345702 | BCPR7ES | |
| 0002345704 | BCPR7ET | |
| 0002435701 | BPR6HS | V-Line No. 3 |
| 0002630701 | PTR5A-13 | V-Line No. 25 |
| 0002630715 | LTR6B-10T | |
| 0002630900 | TR55 | |
| 0002635700 | BPR6EFS | V-Line No. 7 |
| 0002635701 | BPR6EFS-13 | |
| 0002640100 | BUR6EFSZ | |
| 0002640700 | BPR6EFS | V-Line No. 7 |
| 0002640701 | BPR6FS | |
| 0002640900 | PTR5A-13 | V-Line No. 25 |
| 0100220103 | Y-207T | |
| 105MJ | Y-403-1 | |
| 12ZR7SP03 | PLZKBR7A-G | |
| 141MJ | Y-207T | |
| 144DP0 | BP7ES | |
| 145BU | BP7HS | |
| 145DTU | BP6ET | V-Line No. 1 |
| 145DU | BP7ES | |
| 145DU0 | BP7ES | |
| 146BU | BP6HS | V-Line No. 18 |
| 146DP0 | BP6ES | V-Line No. 4 |
| 146DTU | BP6ET | V-Line No. 1 |
| 146DU | BP6ES | V-Line No. 4 |
| 146DU0 | BP6ESZ | |
| 147BU | BP6HS | V-Line No. 18 |
| 147DTU | BP6ET | V-Line No. 1 |
| 147DU | BP6ES | V-Line No. 4 |
| 147DU0 | BP6ESZ | |
| 148AU | B5HS | |
| 148BU | BP5HS | |
| 148DTU | BP5ET-10 | |



| BERU | → NGK Typ | V-LINE |
|--------------|------------------|---------------|
| 148DU | BP5ES | V-Line No. 8 |
| 148DU0 | BP5ESZ | |
| 148LUR | ZGR5A | V-Line No. 15 |
| 149DTU | BP5ET | |
| 149DU | BP5ES | V-Line No. 8 |
| 149DU0 | BP5ESZ | |
| 14F5DU | BCP7ES | |
| 14F6DPUR021 | PFR7Q | |
| 14F6DSR | BKR6ES | V-Line No. 28 |
| 14F6DTU | BCP6ET | |
| 14F6DU0 | BCP6ES | V-Line No. 17 |
| 14F6DUOR | BKR6ES | V-Line No. 28 |
| 14F7DPUR02 | PFR6Q | V-Line No. 37 |
| 14F7DPURX2 | IFR6D10 | |
| 14F7DU | BCP6ES | V-Line No. 17 |
| 14F7DU0 | BCP6ES | V-Line No. 17 |
| 14F7DUOR | BKR6ES | V-Line No. 28 |
| 14F7HPURX2 | PZFR5D-11 | V-Line No. 34 |
| 14F7HUR2 | ZFR5P-G | |
| 14F7LDUR | BKR6EK | V-Line No. 20 |
| 14F7LDUR4 | BKR6EK | V-Line No. 20 |
| 14F8DU | BCP5ES | V-Line No. 16 |
| 14F8DU0 | BCP5ES | V-Line No. 16 |
| 14F8DU4 | BCP5ES | V-Line No. 16 |
| 14F8DUR | BKR6EZB | |
| 14F8LDUSR | BKR6EK | V-Line No. 20 |
| 14F8LUR | ZFR5F | |
| 14F9DU0 | BCP5ES | V-Line No. 16 |
| 14FGH6DTUR | BKUR6ET | V-Line No. 27 |
| 14FGH7DPURX2 | IFR6D10 | |
| 14FGH7DTURX | BKUR6ET-10 | V-Line No. 24 |
| 14FGH8DPURX2 | IFR5D10 | |
| 14FGH8DTURW | BKUR5ET | V-Line No. 29 |
| 14FGH8DTURX0 | BKUR5ET-10 | |
| 14FGR6DDU | BKR6EKUB | |
| 14FGR7CTU | BCPR7ET | |
| 14FLR8LDUX | BKR5EK | V-Line No. 23 |
| 14FR5DTU | BCPR7ET | |
| 14FR5DU | BCPR7ES | |
| 14FR6DU | BKR6ES | V-Line No. 28 |
| 14FR6DUX | BKR6ES-11 | V-Line No. 14 |
| 14FR6LDU | BKR6EK | V-Line No. 20 |
| 14FR6LDU3 | BKR6EKE | |
| 14FR6LDUW | BKR6EKC | V-Line No. 26 |
| 14FR7DQUP7 | BKR6EQUP | V-Line No. 30 |
| 14FR7DU | BKR6ES | V-Line No. 28 |
| 14FR7DUX | BKR6ES-11 | V-Line No. 14 |
| 14FR7KPU | BKR6EP-8 | |
| 14FR7KPUV | BCPR6EP-11 | |
| 14FR7KPUX | BCPR6EP-11 | |
| 14FR7KU | BKR6EY | |
| 14FR7KU0 | BKR6EYA | |

| BERU | → NGK Typ | V-LINE |
|-------------|------------------|---------------|
| 14FR7KUOX | BKR6EYA-11 | |
| 14FR7LDU | BKR6EK | V-Line No. 20 |
| 14FR7LUX | ZFR6F-11 | |
| 14FR7MU2 | LFR6B | |
| 14FR8DU | BKR5ES | V-Line No. 35 |
| 14FR8DUX | BKR5ES-11 | V-Line No. 33 |
| 14FR8HU | BCRE527Y | |
| 14FR8KU | BKR5EY | |
| 14FR8KU0 | BKR5EYA | |
| 14FR8KU0U | BKR5EYA-11 | V-Line No. 39 |
| 14FR8LDUOX4 | BKR5EK | V-Line No. 23 |
| 14G8DTU | BUR5ET | V-Line No. 22 |
| 14GH7DTUR | BUR6ET | V-Line No. 1 |
| 14GH8DTUR | BUR5ET | V-Line No. 22 |
| 14GH8DTURX | BUR5ET-10 | V-Line No. 21 |
| 14GR8DTU | BPR5EKU | |
| 14K5DU | BP7EFS | |
| 14K5DU0 | BP7EFS | |
| 14K6DU | BP6EFS | V-Line No. 5 |
| 14K6DU0 | BP6EFS | V-Line No. 5 |
| 14K7DU | BP6EFS | V-Line No. 5 |
| 14K7DU0 | BP6EFS | V-Line No. 5 |
| 14K8DU | BP5EFS | |
| 14K8DU0 | BP5EFS | |
| 14K9DU | BP5EFS | |
| 14K9DU0 | BP5EFS | |
| 14KGR6KQU | BUR6EFSZ | |
| 14KR6BU | BPR6FS | |
| 14KR6DU | BPR6EFS | V-Line No. 7 |
| 14KR6ZPPV | PTR5A-13 | V-Line No. 25 |
| 14KR7DU | BPR6EFS | V-Line No. 7 |
| 14KR7DUX | BPR6EFS-13 | |
| 14KR8DPU0V | TR55 | |
| 14KR8MPX | PTR5A-13 | V-Line No. 25 |
| 14KR8MUV | PTR5A-13 | V-Line No. 25 |
| 14KR8STUX | LTR6B-10T | |
| 14R5DU | BPR7ES | V-Line No. 19 |
| 14R6BU | BPR6HS | V-Line No. 3 |
| 14R6DU | BPR6ES | V-Line No. 2 |
| 14R6DUX | BPR6ES-11 | V-Line No. 13 |
| 14R7BU | BPR6HS | V-Line No. 3 |
| 14R7CU | BR6ES | |
| 14R7DU | BPR6ES | V-Line No. 2 |
| 14R7DUX | BPR6ES-11 | V-Line No. 13 |
| 14R8DU | BPR5ES | V-Line No. 6 |
| 14R8DUX | BPR5ES-11 | |
| 14R9DU | BPR5ES | V-Line No. 6 |
| 162MJ | Y-207T | |
| 171MJ | Y-810 | |
| 18K12B | AP5FS | |
| 18K6BU | AP6FS | |
| 18K7BU | AP6FS | |



| BERU | → NGK Typ | V-LINE |
|-------------|------------------|---------------|
| 18K8BU | AP5FS | |
| RS16 | BPR6HIX | |
| RS33 | BPR5EIX | |
| RS35 | BPR6EIX | |
| Z1 | BP5ES | V-Line No. 8 |
| Z10 | BP6HS | V-Line No. 18 |
| Z100 | BCP5ES | V-Line No. 16 |
| Z101 | BKR6EK | V-Line No. 20 |
| Z103 | BP7ES | |
| Z104 | BP6ES | V-Line No. 4 |
| Z105 | BKR6ES | V-Line No. 28 |
| Z11 | BP6ES | V-Line No. 4 |
| Z116 | BKR6EK | V-Line No. 20 |
| Z118 | BP5HS | |
| Z12 | BP6ET | V-Line No. 1 |
| Z121 | BKUR5ET-10 | |
| Z122 | IFR5D10 | |
| Z13 | BKR6ES | V-Line No. 28 |
| Z14 | BKR6EK | V-Line No. 20 |
| Z144 | BUR6EFSZ | |
| Z145 | BKR6EKUB | |
| Z148 | TR55 | |
| Z149 | BCPR6EP-11 | |
| Z15 | BKR6ES | V-Line No. 28 |
| Z150 | BCPR6EP-11 | |
| Z151 | BKR6EP-8 | |
| Z152 | BCRE527Y | |
| Z153 | BKR5EY | |
| Z154 | BKR5EYA | |
| Z155 | BKR6EY | |
| Z156 | BKR6EYA | |
| Z157 | BKR6EYA-11 | |
| Z158 | ZFR6F-11 | |
| Z16 | BKR6ES-11 | V-Line No. 14 |
| Z17 | BP6EFS | V-Line No. 5 |
| Z171 | IFR6D10 | |
| Z176 | PZFR5D-11 | V-Line No. 34 |
| Z177 | PTR5A-13 | V-Line No. 25 |
| Z18 | BP6EFS | V-Line No. 5 |
| Z184 | LFR6B | |
| Z185 | PFR7Q | |
| Z188 | PFR6Q | V-Line No. 37 |
| Z19 | BPR6HS | V-Line No. 3 |
| Z194 | BKR6EKE | |
| Z2 | BP5ET-10 | |
| Z20 | BPR6ES | V-Line No. 2 |
| Z200 | ZFR5P-G | |
| Z21 | BPR6ES-11 | V-Line No. 13 |
| Z22 | BP6ES | V-Line No. 4 |
| Z222 | LTR6B-10T | |
| Z227 | BKR6EZB | |
| Z23 | BKR6ES | V-Line No. 28 |

| BERU | → NGK Typ | V-LINE |
|-------------|------------------|---------------|
| Z237 | BKR6EQUP | V-Line No. 30 |
| Z24 | BKR6ES | V-Line No. 28 |
| Z245 | BKR6EKC | V-Line No. 26 |
| Z246 | BKUR5ET | V-Line No. 29 |
| Z248 | BKR5EYA-11 | V-Line No. 39 |
| Z25 | BP6EFS | V-Line No. 5 |
| Z26 | BPR6EFS | V-Line No. 7 |
| Z27 | BPR6ES | V-Line No. 2 |
| Z28 | BPR6ES-11 | V-Line No. 13 |
| Z282 | IFR6D10 | |
| Z288 | PLZKBR7A-G | |
| Z29 | BCP7ES | |
| Z3 | ZGR5A | V-Line No. 15 |
| Z30 | BCPR7ES | |
| Z31 | BP7EFS | |
| Z32 | AP6FS | |
| Z33 | AP6FS | |
| Z4 | ZFR5F | |
| Z41 | BP7HS | |
| Z42 | BP7ES | |
| Z43 | BP7ES | |
| Z44 | BP6ET | V-Line No. 1 |
| Z45 | BCPR7ET | |
| Z46 | BP7EFS | |
| Z47 | BPR7ES | V-Line No. 19 |
| Z48 | BP6HS | V-Line No. 18 |
| Z49 | BPR6FS | |
| Z5 | BCP5ES | V-Line No. 16 |
| Z50 | BP6ESZ | |
| Z51 | BP6ET | V-Line No. 1 |
| Z52 | BCP6ET | |
| Z53 | BCP6ET | |
| Z54 | BCP6ES | V-Line No. 17 |
| Z55 | BP6EFS | V-Line No. 5 |
| Z56 | BP6EFS | V-Line No. 5 |
| Z59 | BR6ES | |
| Z6 | BP5EFS | |
| Z60 | BCPR7ET | |
| Z61 | BP6ESZ | |
| Z62 | BP6ESZ | |
| Z63 | BCP6ES | V-Line No. 17 |
| Z64 | BCP6ES | V-Line No. 17 |
| Z67 | BPR6EFS-13 | |
| Z68 | B5HS | |
| Z69 | BP5ESZ | |
| Z7 | BP5EFS | |
| Z70 | BP5ESZ | |
| Z71 | BCP5ES | V-Line No. 16 |
| Z72 | BKR5ES | V-Line No. 35 |
| Z73 | BKR5ES-11 | V-Line No. 33 |
| Z74 | BKR5EK | V-Line No. 23 |
| Z75 | BUR5ET | V-Line No. 22 |



| BERU | → NGK Typ | V-LINE |
|-------------|------------------|---------------|
| Z76 | BP5ES | V-Line No. 8 |
| Z77 | BP5ESZ | |
| Z78 | BP5ET | |
| Z79 | BCP5ES | V-Line No. 16 |
| Z8 | BPR5ES | V-Line No. 6 |
| Z80 | BP5EFS | |
| Z81 | BP5EFS | |
| Z82 | BPR5ES | V-Line No. 6 |
| Z89 | BKUR6ET | V-Line No. 27 |
| Z9 | BPR5ES-11 | |
| Z90 | BKUR6ET-10 | V-Line No. 24 |
| Z91 | BUR6ET | V-Line No. 1 |
| Z92 | BUR5ET | V-Line No. 22 |
| Z93 | BUR5ET-10 | V-Line No. 21 |
| Z94 | BPR5EKU | |
| Z95 | BPR6EFS | V-Line No. 7 |
| Z97 | PTR5A-13 | V-Line No. 25 |
| Z98 | BKR6EK | V-Line No. 20 |
| Z99 | BKR6ES-11 | V-Line No. 14 |

| BMW | → NGK Typ | V-LINE |
|-----------------|------------------|---------------|
| 0022902 | DCPR8EKP | |
| 0030548 | BKR6EQUP | V-Line No. 30 |
| 0031708 | BKR7EQUP | |
| 0032134 | IZFR6H11 | |
| 0032136 | BKR6EQU | |
| 0032137 | ILZFR6D11 | |
| 0032273 | LKR8AP | |
| 0034091 | ZKBR7AP-HTU | |
| 0034094 | R6601-9 | |
| 0034098 | PLZKBR7A-G | |
| 0035531 | ILZKBR7A-8G | |
| 0035747 | PFR7B | |
| 0035915 | PLZFR6A-11S | |
| 0037607 | BKR6EQUP | V-Line No. 30 |
| 0037608 | BKR6EQUP | V-Line No. 30 |
| 0038349 | ZKBR7A-HTU | |
| 0038507 | SIZKBR8A8HS | |
| 0141871 | BKR6EQUP | V-Line No. 30 |
| 12 12 0 022 902 | DCPR8EKP | |
| 12 12 0 030 548 | BKR6EQUP | V-Line No. 30 |
| 12 12 0 031 708 | BKR7EQUP | |
| 12 12 0 032 134 | IZFR6H11 | |
| 12 12 0 032 136 | BKR6EQU | |
| 12 12 0 032 137 | ILZFR6D11 | |
| 12 12 0 032 273 | LKR8AP | |
| 12 12 0 034 091 | ZKBR7AP-HTU | |
| 12 12 0 034 094 | R6601-9 | |
| 12 12 0 034 098 | PLZKBR7A-G | |
| 12 12 0 035 531 | ILZKBR7A-8G | |
| 12 12 0 035 747 | PFR7B | |
| 12 12 0 035 915 | PLZFR6A-11S | |

| BMW | → NGK Typ | V-LINE |
|-----------------|------------------|---------------|
| 12 12 0 037 607 | BKR6EQUP | V-Line No. 30 |
| 12 12 0 037 608 | BKR6EQUP | V-Line No. 30 |
| 12 12 0 038 349 | ZKBR7A-HTU | |
| 12 12 0 038 507 | SIZKBR8A8HS | |
| 12 12 0 141 871 | BKR6EQUP | V-Line No. 30 |
| 12 12 1 435 955 | BKR6EQUP | V-Line No. 30 |
| 12 12 1 704 399 | BKR6EK | V-Line No. 20 |
| 12 12 2 158 252 | IZFR6H11 | |
| 12 12 2 158 253 | PLZFR6A-11S | |
| 12 12 7 521 112 | ILZFR6D11 | |
| 12 12 7 526 799 | IZFR6H11 | |
| 12 12 7 550 010 | ZKBR7AP-HTU | |
| 12 12 7 556 979 | BKR7EQUP | |
| 12 12 7 570 106 | ILZKBR7A-8G | |
| 12 12 7 600 994 | SIZKBR8A8HS | |
| 12 12 7 671 301 | DCPR8EKC | |
| 12 12 7 677 560 | DCPR8EKC | |
| 12 12 7 728 634 | DCPR8EKC | |
| 12 12 7 835 198 | LKR8AP | |
| 12 12 9 061 870 | ZFR5F | |
| 12 12 9 063 428 | BKR6EK | V-Line No. 20 |
| 12 12 9 064 617 | BKR6EK | V-Line No. 20 |
| 12 12 9 064 619 | BKR6EK | V-Line No. 20 |
| 12 12 9 064 656 | BKR6EK | V-Line No. 20 |
| 12 12 9 065 366 | BKR6EK | V-Line No. 20 |
| 12 12 9 069 048 | PKR7A | |
| 12 12 9 071 003 | BKR6EQUP | V-Line No. 30 |
| 1210043 | PFR7B | |
| 1435955 | BKR6EQUP | V-Line No. 30 |
| 1704399 | BKR6EK | V-Line No. 20 |
| 2158252 | IZFR6H11 | |
| 2158253 | PLZFR6A-11S | |
| 7521112 | ILZFR6D11 | |
| 7526799 | IZFR6H11 | |
| 7550010 | ZKBR7AP-HTU | |
| 7550011 02 | ZKBR7A-HTU | |
| 7556979 | BKR7EQUP | |
| 7570106 | ILZKBR7A-8G | |
| 7570106 02 | ILZKBR7A-8G | |
| 7600994 | SIZKBR8A8HS | |
| 7671301 | DCPR8EKC | |
| 7677560 | DCPR8EKC | |
| 7728634 | DCPR8EKC | |
| 7830787.3 | DCPR8EKP | |
| 7835198 | LKR8AP | |
| 9061870 | ZFR5F | |
| 9063428 | BKR6EK | V-Line No. 20 |
| 9064617 | BKR6EK | V-Line No. 20 |
| 9064619 | BKR6EK | V-Line No. 20 |
| 9064656 | BKR6EK | V-Line No. 20 |
| 9065366 | BKR6EK | V-Line No. 20 |
| 9069048 | PKR7A | |



| BMW | → NGK Typ | V-LINE |
|-----------------|------------------|---------------|
| 9071003 | BKR6EQU | V-Line No. 30 |
| 91 47 1 210 043 | PFR7B | |
| BOSCH | → NGK Typ | V-LINE |
| 0 241 219 537 | BP4FS | |
| 0 241 225 013 | BP5ES | V-Line No. 8 |
| 0 241 225 543 | BP4FS | |
| 0 241 225 545 | BP5ES | V-Line No. 8 |
| 0 241 225 549 | B5HS | |
| 0 241 225 550 | BP5ES | V-Line No. 8 |
| 0 241 225 555 | BPR4FS-15 | |
| 0 241 225 556 | BP5ES | V-Line No. 8 |
| 0 241 225 558 | BP5EFS | |
| 0 241 225 573 | BP5EFS | |
| 0 241 225 574 | BCPR4ES-11 | |
| 0 241 225 576 | BP5ET | |
| 0 241 225 582 | BP5ES-11 | |
| 0 241 225 585 | ZGR5A | V-Line No. 15 |
| 0 241 229 059 | ZGR5A | V-Line No. 15 |
| 0 241 229 060 | BP5ET-10 | |
| 0 241 229 061 | BP5ES | V-Line No. 8 |
| 0 241 229 062 | BP5ES | V-Line No. 8 |
| 0 241 229 574 | BP5ES | V-Line No. 8 |
| 0 241 229 578 | BP5HS | |
| 0 241 229 588 | BP5ES | V-Line No. 8 |
| 0 241 229 594 | BP5FS | |
| 0 241 229 596 | BP5ES-11 | |
| 0 241 229 604 | B5HS | |
| 0 241 229 612 | B5HS | |
| 0 241 229 617 | BP5EFS | |
| 0 241 229 619 | BP5ET | |
| 0 241 229 634 | BCP5ES | V-Line No. 16 |
| 0 241 229 639 | ZFR5F | |
| 0 241 229 641 | BP5HS | |
| 0 241 229 649 | BP5EFS | |
| 0 241 229 657 | ZFR5F | |
| 0 241 229 661 | BUR6ET | V-Line No. 1 |
| 0 241 229 663 | BUR5ET-10 | V-Line No. 21 |
| 0 241 229 665 | BUR5ET | V-Line No. 22 |
| 0 241 229 666 | BKR6EK | V-Line No. 20 |
| 0 241 229 676 | BKUR5ET | V-Line No. 29 |
| 0 241 229 682 | BCP5ES-11 | |
| 0 241 229 684 | BKR5ES | V-Line No. 35 |
| 0 241 229 685 | BCP5ES | V-Line No. 16 |
| 0 241 229 704 | IFR5D10 | |
| 0 241 235 099 | BPR6ES | V-Line No. 2 |
| 0 241 235 103 | BP6ESZ | |
| 0 241 235 108 | BCP6ET | |
| 0 241 235 563 | BP6ES | V-Line No. 4 |
| 0 241 235 564 | BP6HS | V-Line No. 18 |
| 0 241 235 602 | BP6ES | V-Line No. 4 |
| 0 241 235 610 | BP6ES-11 | |

| BOSCH | → NGK Typ | V-LINE |
|---------------|------------------|---------------|
| 0 241 235 633 | BP6ET | V-Line No. 1 |
| 0 241 235 635 | BP6EFS | V-Line No. 5 |
| 0 241 235 636 | BP6EFS | V-Line No. 5 |
| 0 241 235 638 | BR6EF | |
| 0 241 235 643 | BP6ET | V-Line No. 1 |
| 0 241 235 646 | BP6EFS-13 | |
| 0 241 235 668 | BP6EFS | V-Line No. 5 |
| 0 241 235 673 | BCP6ES | V-Line No. 17 |
| 0 241 235 674 | ZFR6A-11 | |
| 0 241 235 676 | BCP6ES | V-Line No. 17 |
| 0 241 235 681 | BP6EFS | V-Line No. 5 |
| 0 241 235 685 | BCP6ES-11 | |
| 0 241 235 690 | BKR6EK | V-Line No. 20 |
| 0 241 235 692 | ZFR6F-11 | |
| 0 241 235 693 | BP6ESZ | |
| 0 241 235 697 | BKUR6ET-10 | V-Line No. 24 |
| 0 241 235 698 | BUR6ET | V-Line No. 1 |
| 0 241 235 705 | BP6ESZ | |
| 0 241 235 706 | BKUR6ET-10 | V-Line No. 24 |
| 0 241 235 715 | PZFR5D-11 | V-Line No. 34 |
| 0 241 235 735 | ZFR5P-G | |
| 0 241 235 736 | BKR6ES | V-Line No. 28 |
| 0 241 235 739 | IFR6D10 | |
| 0 241 240 057 | BP6ESZ | |
| 0 241 240 058 | BP6ESZ | |
| 0 241 240 524 | BP6EFS | V-Line No. 5 |
| 0 241 240 530 | BP6ES | V-Line No. 4 |
| 0 241 240 532 | BP6HS | V-Line No. 18 |
| 0 241 240 539 | BP6ES | V-Line No. 4 |
| 0 241 240 542 | BCP6ES | V-Line No. 17 |
| 0 241 240 543 | BP6FS | |
| 0 241 240 558 | BP6ET | V-Line No. 1 |
| 0 241 240 563 | BP6EFS | V-Line No. 5 |
| 0 241 240 564 | BCP6ET | |
| 0 241 240 569 | BCP6ES-11 | |
| 0 241 240 574 | BP6ES-11 | |
| 0 241 240 578 | BP6EFS | V-Line No. 5 |
| 0 241 240 585 | BKR6EVX | |
| 0 241 240 587 | BKR6ES | V-Line No. 28 |
| 0 241 240 592 | BKUR7ET | |
| 0 241 240 631 | ILFR6A | |
| 0 241 245 070 | BP6ET | V-Line No. 1 |
| 0 241 245 552 | BP7ES | |
| 0 241 245 553 | BP7HS | |
| 0 241 245 570 | BP7EFS | |
| 0 241 245 599 | BP7ES | |
| 0 241 245 619 | BP7HS | |
| 0 241 245 636 | BP7EFS | |
| 0 241 245 641 | PFR7B | |
| 0 241 245 642 | BCP7ES | |
| 0 241 255 505 | B8EFS | |
| 0 241 255 507 | R7433-9 | |



| BOSCH | → NGK Typ | V-LINE |
|---------------|------------------|---------------|
| 0 241 260 510 | B9EFS | |
| 0 241 260 512 | R7433-9 | |
| 0 241 268 506 | B10EGV | |
| 0 241 274 505 | B10EGV | |
| 0 241 280 503 | B11EGV | |
| 0 241 309 501 | AP5FS | |
| 0 241 319 510 | AP5FS | |
| 0 241 325 509 | AP5FS | |
| 0 241 329 520 | AP5FS | |
| 0 241 335 516 | AP6FS | |
| 0 241 335 520 | A6FS | |
| 0 241 340 501 | AP6FS | |
| 0 242 129 503 | LZKAR7A | |
| 0 242 129 508 | LZKAR7A | |
| 0 242 135 501 | DCPR8E-N | |
| 0 242 135 509 | PLKR7A | |
| 0 242 140 504 | DCPR8EKC | |
| 0 242 145 503 | DCPR8EKC | |
| 0 242 219 511 | BPR4FS-15 | |
| 0 242 219 514 | BR5FS | |
| 0 242 219 515 | BR5FS | |
| 0 242 219 516 | BPR4FS | |
| 0 242 219 517 | BPR4FS-11 | |
| 0 242 219 519 | BCPR4ES-11 | |
| 0 242 219 529 | ZGR5B | |
| 0 242 219 530 | BPR4ES-13 | |
| 0 242 225 523 | BR5ES | |
| 0 242 225 524 | BPR5ES | V-Line No. 6 |
| 0 242 225 525 | BPR5ES-13 | |
| 0 242 225 528 | ZGR5C | |
| 0 242 225 529 | BR5FS | |
| 0 242 225 530 | BR5FS | |
| 0 242 225 531 | BPR4FS | |
| 0 242 225 532 | BPR4FS-15 | |
| 0 242 225 533 | BPR5EFS | |
| 0 242 225 534 | BPR5EFS-13 | |
| 0 242 225 537 | ZFR4F-11 | |
| 0 242 225 538 | BPR5EIX | |
| 0 242 225 539 | ZGR5A | V-Line No. 15 |
| 0 242 225 548 | BPR5ES-11 | |
| 0 242 225 549 | BCPR4ES-11 | |
| 0 242 225 550 | BPR5ES | V-Line No. 6 |
| 0 242 225 582 | BKR5ES | V-Line No. 35 |
| 0 242 225 599 | BPR5ES | V-Line No. 6 |
| 0 242 225 622 | BPR4FS | |
| 0 242 225 624 | BPR5ES-11 | |
| 0 242 225 641 | BPR4FS-15 | |
| 0 242 225 859 | BPR5ES | V-Line No. 6 |
| 0 242 229 526 | BR5FS | |
| 0 242 229 528 | BPR5FS | |
| 0 242 229 529 | BPR5FS-15 | |
| 0 242 229 530 | BKR5ES-11 | V-Line No. 33 |

| BOSCH | → NGK Typ | V-LINE |
|---------------|------------------|---------------|
| 0 242 229 531 | BPR5ES | V-Line No. 6 |
| 0 242 229 533 | BR5ES | |
| 0 242 229 537 | BPR5EIX | |
| 0 242 229 538 | BPR5ES | V-Line No. 6 |
| 0 242 229 566 | BPR5ES-11 | |
| 0 242 229 568 | BKR5ES | V-Line No. 35 |
| 0 242 229 570 | BPR5ES | V-Line No. 6 |
| 0 242 229 576 | ZFR6F-11 | |
| 0 242 229 587 | BKR5ES | V-Line No. 35 |
| 0 242 229 589 | BPR5HS | |
| 0 242 229 591 | BKR5EK | V-Line No. 23 |
| 0 242 229 594 | BKR5ES | V-Line No. 35 |
| 0 242 229 598 | BKR5EVX | |
| 0 242 229 605 | BKR5EK | V-Line No. 23 |
| 0 242 229 607 | BPR5ES | V-Line No. 6 |
| 0 242 229 610 | BPR5HS | |
| 0 242 229 613 | BKR5EKUP | |
| 0 242 229 625 | BKUR5ET-10 | |
| 0 242 229 626 | BKR5EK | V-Line No. 23 |
| 0 242 229 628 | BKR5EK | V-Line No. 23 |
| 0 242 229 630 | LF5B | |
| 0 242 229 634 | PLFR5A-11 | |
| 0 242 229 635 | BKR5EYA-11 | V-Line No. 39 |
| 0 242 229 641 | PTR5D-10 | V-Line No. 31 |
| 0 242 229 648 | BKR5EQUA | |
| 0 242 229 650 | TR5B-13 | |
| 0 242 229 654 | BKR5EK | V-Line No. 23 |
| 0 242 229 655 | BPR5EFS | |
| 0 242 229 656 | BPR5ES | V-Line No. 6 |
| 0 242 229 657 | BPR5HS | |
| 0 242 229 658 | BUR5ET-10 | V-Line No. 21 |
| 0 242 229 659 | BKR5ES | V-Line No. 35 |
| 0 242 229 660 | BKR5ES-11 | V-Line No. 33 |
| 0 242 229 661 | LTR6B-10T | |
| 0 242 229 671 | BKR5EKB-11 | |
| 0 242 229 673 | BKR5ES | V-Line No. 35 |
| 0 242 229 687 | BPR5ES-11 | |
| 0 242 229 699 | ZFR5F-11 | |
| 0 242 229 708 | ILFR5B11 | |
| 0 242 229 713 | IFR5D10 | |
| 0 242 229 724 | BKR6EZB | |
| 0 242 229 779 | ZGR5A | V-Line No. 15 |
| 0 242 229 781 | BKR5EKB-11 | |
| 0 242 229 785 | PTR5A-13 | V-Line No. 25 |
| 0 242 229 878 | BKR5EK | V-Line No. 23 |
| 0 242 229 879 | BPR5EFS | |
| 0 242 229 880 | BPR5ES | V-Line No. 6 |
| 0 242 229 881 | BPR5HS | |
| 0 242 229 883 | BKR5ES | V-Line No. 35 |
| 0 242 229 884 | BKR5ES-11 | V-Line No. 33 |
| 0 242 229 885 | BPR5ES-11 | |
| 0 242 229 925 | IFR5D10 | |



| BOSCH | → NGK Typ | V-LINE |
|---------------|------------------|---------------|
| 0 242 230 500 | IFR5D10 | |
| 0 242 235 511 | BPR6ES | V-Line No. 2 |
| 0 242 235 522 | BPR6HS | V-Line No. 3 |
| 0 242 235 525 | BPR6EVX | |
| 0 242 235 529 | BPR6ES | V-Line No. 2 |
| 0 242 235 530 | BPR6ES-11 | V-Line No. 13 |
| 0 242 235 532 | BR6ES | |
| 0 242 235 537 | BPR6ES | V-Line No. 2 |
| 0 242 235 538 | BPR6EFS | V-Line No. 7 |
| 0 242 235 542 | BPR6EFS | V-Line No. 7 |
| 0 242 235 543 | BR6ES-11 | |
| 0 242 235 544 | BKR6ES-11 | V-Line No. 14 |
| 0 242 235 551 | BKR6ES | V-Line No. 28 |
| 0 242 235 564 | BCPR6ET | |
| 0 242 235 567 | ZFR6F-11 | |
| 0 242 235 571 | BUR6ET | V-Line No. 1 |
| 0 242 235 577 | BPR6EFS-15 | |
| 0 242 235 579 | BKR6ES | V-Line No. 28 |
| 0 242 235 587 | BKR6ES | V-Line No. 28 |
| 0 242 235 588 | BKR6ES | V-Line No. 28 |
| 0 242 235 589 | BKR6EK | V-Line No. 20 |
| 0 242 235 590 | BUR6ET | V-Line No. 1 |
| 0 242 235 592 | BPR6EFS | V-Line No. 7 |
| 0 242 235 597 | BKR6ES | V-Line No. 28 |
| 0 242 235 599 | BKR6EY | |
| 0 242 235 602 | BKR6EY-11 | |
| 0 242 235 605 | BKR6EK | V-Line No. 20 |
| 0 242 235 607 | BUR6EFSZ | |
| 0 242 235 609 | BKR6EZ | V-Line No. 38 |
| 0 242 235 610 | BKR6EP-13 | |
| 0 242 235 616 | BKR6ES | V-Line No. 28 |
| 0 242 235 617 | BKR6EQUP | V-Line No. 30 |
| 0 242 235 624 | BKR6ES | V-Line No. 28 |
| 0 242 235 630 | BPR6ES | V-Line No. 2 |
| 0 242 235 636 | LF6A | |
| 0 242 235 640 | BKR6EZ | V-Line No. 38 |
| 0 242 235 642 | BKR6EKUB | |
| 0 242 235 656 | BKR6EQUP | V-Line No. 30 |
| 0 242 235 659 | BKR6EYA-11 | |
| 0 242 235 661 | BPR6EFS | V-Line No. 7 |
| 0 242 235 663 | BPR6ES | V-Line No. 2 |
| 0 242 235 664 | BUR6ET | V-Line No. 1 |
| 0 242 235 665 | BPR6HS | V-Line No. 3 |
| 0 242 235 666 | BKR6ES | V-Line No. 28 |
| 0 242 235 667 | BKR6ES-11 | V-Line No. 14 |
| 0 242 235 668 | BKR6EK | V-Line No. 20 |
| 0 242 235 690 | PFR6N-11 | |
| 0 242 235 692 | ZFR5E-11 | |
| 0 242 235 699 | BKR6EVX | |
| 0 242 235 707 | BPR6ES-11 | V-Line No. 13 |
| 0 242 235 715 | BKR6EQUP | V-Line No. 30 |
| 0 242 235 740 | PFR6Q | V-Line No. 37 |

| BOSCH | → NGK Typ | V-LINE |
|---------------|------------------|---------------|
| 0 242 235 743 | PLFR6A | |
| 0 242 235 748 | BKR6EKUB | |
| 0 242 235 749 | PFR6B | |
| 0 242 235 761 | ZFR5P-G | |
| 0 242 235 767 | PTR5A-13 | V-Line No. 25 |
| 0 242 235 769 | ILZFR6C-11K | |
| 0 242 235 776 | IZFR6H11 | |
| 0 242 235 908 | BPR6EFS | V-Line No. 7 |
| 0 242 235 909 | BPR6ES | V-Line No. 2 |
| 0 242 235 910 | BUR6ET | V-Line No. 1 |
| 0 242 235 911 | BPR6HS | V-Line No. 3 |
| 0 242 235 912 | BKR6ES | V-Line No. 28 |
| 0 242 235 913 | BKR6ES-11 | V-Line No. 14 |
| 0 242 235 914 | BKR6EK | V-Line No. 20 |
| 0 242 235 915 | BPR6ES-11 | V-Line No. 13 |
| 0 242 235 916 | PTR5A-13 | V-Line No. 25 |
| 0 242 235 917 | BKR6EKUB | |
| 0 242 235 918 | PFR6B | |
| 0 242 235 979 | BPR6EFS | V-Line No. 7 |
| 0 242 235 980 | BKR6EY | |
| 0 242 235 981 | BKR6EQUP | V-Line No. 30 |
| 0 242 235 982 | PFR6Q | V-Line No. 37 |
| 0 242 235 985 | BKR6EY-11 | |
| 0 242 235 986 | ZFR6F-11 | |
| 0 242 236 510 | ILZFR6D11 | |
| 0 242 236 528 | ILFR6B | |
| 0 242 236 541 | BKR6EY-11 | |
| 0 242 236 542 | ZFR6F-11 | |
| 0 242 236 543 | BPR6EFS-15 | |
| 0 242 236 560 | BPR6EFS | V-Line No. 7 |
| 0 242 236 561 | BKR6EY | |
| 0 242 236 562 | BKR6EQUP | V-Line No. 30 |
| 0 242 236 564 | PFR6Q | V-Line No. 37 |
| 0 242 236 566 | PZFR5D-11 | V-Line No. 34 |
| 0 242 236 577 | ILFR6K8 | |
| 0 242 240 511 | BPR6ES | V-Line No. 2 |
| 0 242 240 514 | BPR6EFS | V-Line No. 7 |
| 0 242 240 516 | BPR6EVX | |
| 0 242 240 519 | BPR6EFS | V-Line No. 7 |
| 0 242 240 520 | BPR6FS | |
| 0 242 240 526 | BKR6ES | V-Line No. 28 |
| 0 242 240 528 | BCPR6ET | |
| 0 242 240 531 | BPR6ES-11 | V-Line No. 13 |
| 0 242 240 539 | BKR6ES-11 | V-Line No. 14 |
| 0 242 240 546 | BUR6ET | V-Line No. 1 |
| 0 242 240 547 | BKR5EKC | |
| 0 242 240 557 | BKR6EK | V-Line No. 20 |
| 0 242 240 561 | BPR6HS | V-Line No. 3 |
| 0 242 240 562 | BKR6EZ | V-Line No. 38 |
| 0 242 240 566 | BKR6EK | V-Line No. 20 |
| 0 242 240 569 | BUR6EFSZ | |
| 0 242 240 572 | BKUR6ET | V-Line No. 27 |



| BOSCH | → NGK Typ | V-LINE |
|---------------|------------------|---------------|
| 0 242 240 579 | BPR6ES | V-Line No. 2 |
| 0 242 240 584 | BKR6EKE | |
| 0 242 240 587 | BKR6EQUP | V-Line No. 30 |
| 0 242 240 590 | ZFR6S-Q | |
| 0 242 240 591 | BPR6EFS | V-Line No. 7 |
| 0 242 240 592 | BPR6ES | V-Line No. 2 |
| 0 242 240 593 | BKR6ES | V-Line No. 28 |
| 0 242 240 648 | BKR6EZ | V-Line No. 38 |
| 0 242 240 665 | PZFR6R | |
| 0 242 240 848 | BPR6EFS | V-Line No. 7 |
| 0 242 240 849 | BPR6ES | V-Line No. 2 |
| 0 242 240 850 | BKR6ES | V-Line No. 28 |
| 0 242 245 514 | BPR7EIX | |
| 0 242 245 515 | BCPR7ES | |
| 0 242 245 536 | BCPR7ES | |
| 0 242 245 537 | BPR7ES | V-Line No. 19 |
| 0 242 245 539 | BCPR7ET | |
| 0 242 245 550 | BCPR7ES-11 | |
| 0 242 245 552 | BPR7ES | V-Line No. 19 |
| 0 242 245 559 | BKR7EQUP | |
| 0 242 245 812 | BPR7ES | V-Line No. 19 |
| 0 242 255 501 | BR9ET | |
| 0 242 319 501 | APR5FS | |
| 0 242 325 501 | APR5FS | |
| 0 242 329 503 | APR5FS | |
| 0 242 335 504 | APR6FS | |
| 0 242 340 501 | APR6FS | |
| 8771207 | R2349-10 | |
| 8881101 | R2349-11 | |
| D10BC | AP5FS | |
| D6BC | AP6FS | |
| D7AC | A6FS | |
| D7BC | AP6FS | |
| D8BC | AP5FS | |
| D9BC | AP5FS | |
| DR10BC | APR5FS | |
| DR6BC | APR6FS | |
| DR7BC | APR6FS | |
| DR8BC | APR5FS | |
| DR9BC | APR5FS | |
| F03DAR | BKR6EK | V-Line No. 20 |
| F04DAR | BKR6EK | V-Line No. 20 |
| F2CS | R7433-9 | |
| F2DTC | R6888A-9 | |
| F3CS | R7433-9 | |
| F5DC | BCP7ES | |
| F5DPOR | PFR7B | |
| F5DTC | BCP7ET | |
| F5KPP332SB | PFR7S8EG | |
| F6DC | BCP6ES | V-Line No. 17 |
| F6DC0 | BCP6ES | V-Line No. 17 |
| F6DCOR | BKR6ES | V-Line No. 28 |

| BOSCH | → NGK Typ | V-LINE |
|--------------|------------------|---------------|
| F6DCX | BCP6ES-11 | |
| F6DPOR | PFR6Q | V-Line No. 37 |
| F6DSR | BKR6EVX | |
| F6DTC | BCP6ET | |
| F6KPP332S | PFR6Q | V-Line No. 37 |
| F6LTCR | BKUR7ET | |
| F6MPP332 | ILFR6A | |
| F7DC | BCP6ES | V-Line No. 17 |
| F7DC0 | BCP6ES | V-Line No. 17 |
| F7DCOR | BKR6ES | V-Line No. 28 |
| F7DCX | BCP6ES-11 | |
| F7DER | BKR6ES | V-Line No. 28 |
| F7DPER | PFR6G-11 | |
| F7DPP332 | IFR6D10 | |
| F7DTC | BCP6ET | |
| F7HER2 | ZFR5P-G | |
| F7HPP22 | PFR6Q | V-Line No. 37 |
| F7HPP222 | PZFR5D-11 | V-Line No. 34 |
| F7HPP222U | PZFR6J-11 | |
| F7HPPRX | PZFR5D-11 | V-Line No. 34 |
| F7KPP332U | PFR6X-11 | |
| F7KTCR | BKUR6ET-10 | V-Line No. 24 |
| F7LC0R2 | ZFR6F-11 | |
| F7LCR | ZFR6A-11 | |
| F7LDCR | BKR6EK | V-Line No. 20 |
| F7LTCR | BKUR6ET-10 | V-Line No. 24 |
| F8DC | BCP5ES | V-Line No. 16 |
| F8DC0 | BCP5ES | V-Line No. 16 |
| F8DC0R | BKR5ES | V-Line No. 35 |
| F8DC4 | BCP5ES | V-Line No. 16 |
| F8DCX | BCP5ES-11 | |
| F8DPER | IFR5D10 | |
| F8DPP332 | IFR5D10 | |
| F8KTCR | BKUR5ET | V-Line No. 29 |
| F8LCR | ZFR5F | |
| F8LCR2 | ZFR5F | |
| F8LDCR | BKR6EK | V-Line No. 20 |
| F9DC0 | BCPR4ES-11 | |
| F9LCR | ZFR4F-11 | |
| FGR5KQE0 | BKR7EQUP | |
| FGR6HQE0 | ZFR6S-Q | |
| FGR6KQC | BKR6EQUP | V-Line No. 30 |
| FGR6KQE | BKR6EQUP | V-Line No. 30 |
| FGR7DQE+ | BKR6EKUB | |
| FGR7DQE0 | BKR6EKUB | |
| FGR7DQP | BKR6EQUP | V-Line No. 30 |
| FGR7DQP+ | BKR6EQUP | V-Line No. 30 |
| FGR7KQC | BKR6EQUP | V-Line No. 30 |
| FGR7KQE | BKR6EQUP | V-Line No. 30 |
| FGR7KQE0 | BKR6EQUP | V-Line No. 30 |
| FGR8KQE | BKR5EKUP | |
| FGR8KQE0 | BKR5EQUPA | |



| BOSCH | → NGK Typ | V-LINE |
|--------------|------------------|---------------|
| FGR8MQPE | PLFR5A-11 | |
| FLR8LD+U | BKR5EK | V-Line No. 23 |
| FLR8LDCU | BKR5EK | V-Line No. 23 |
| FLR8LDCU+ | BKR5EK | V-Line No. 23 |
| FQR8DE | BKR6EZB | |
| FQR8LEU2 | ZFR5F-11 | |
| FR10DCX | BCPR4ES-11 | |
| FR5DC | BCPR7ES | |
| FR5DCX | BCPR7ES-11 | |
| FR5DTC | BCPR7ET | |
| FR6D133 | IFR6J11 | |
| FR6DC | BKR6ES | V-Line No. 28 |
| FR6DC+ | BKR6ES | V-Line No. 28 |
| FR6DC0 | BKR6EK | V-Line No. 20 |
| FR6DC2 | BKR6ES | V-Line No. 28 |
| FR6DCX | BKR6ES-11 | V-Line No. 14 |
| FR6DTC | BCPR6ET | |
| FR6DTCW | BKR5EKC | |
| FR6HI332 | PZFR6R | |
| FR6KDC | BKR6EZ | V-Line No. 38 |
| FR6KDC+ | BKR6EZ | V-Line No. 38 |
| FR6KDE0 | BKR6EKE | |
| FR6KTC | BKUR6ET | V-Line No. 27 |
| FR6LDC | BKR6EK | V-Line No. 20 |
| FR6MPP10 | PLFR6A-11 | |
| FR7DC | BKR6ES | V-Line No. 28 |
| FR7DC+ | BKR6ES | V-Line No. 28 |
| FR7DC0 | BKR6ES | V-Line No. 28 |
| FR7DC2 | BKR6ES | V-Line No. 28 |
| FR7DC4 | BKR6ES | V-Line No. 28 |
| FR7DCX | BKR6ES-11 | V-Line No. 14 |
| FR7DCX+ | BKR6ES-11 | V-Line No. 14 |
| FR7DE | BKR6EZ | V-Line No. 38 |
| FR7DPP+ | PFR6B | |
| FR7DPP10 | BKR6EVX | |
| FR7DPP22U | PFR6N-11 | |
| FR7DPP33 | PFR6Q | V-Line No. 37 |
| FR7DQP | BKR6EQUP | V-Line No. 30 |
| FR7DTC | BCPR6ET | |
| FR7HC0X | ZFR5E-11 | |
| FR7HE2 | ZFR5P-G | |
| FR7HPP33+ | PZFR5D-11 | V-Line No. 34 |
| FR7KC | BKR6EY | |
| FR7KC+ | BKR6EY | |
| FR7KCU | BKR6EYA-11 | |
| FR7KCW | BKR6EP-13 | |
| FR7KCX | BKR6EY-11 | |
| FR7KCX+ | BKR6EY-11 | |
| FR7KDC | BKR6EZ | V-Line No. 38 |
| FR7KI30 | FR6EI | |
| FR7KPP33+ | PFR6Q | V-Line No. 37 |
| FR7KPP332 | IZFR6H11 | |

| BOSCH | → NGK Typ | V-LINE |
|--------------|------------------|---------------|
| FR7LC2 | BKR6ES | V-Line No. 28 |
| FR7LCX | ZFR6F-11 | |
| FR7LCX+ | ZFR6F-11 | |
| FR7LDC | BKR6EK | V-Line No. 20 |
| FR7LDC+ | BKR6EK | V-Line No. 20 |
| FR7LDU | BKR6EK | V-Line No. 20 |
| FR7ME | LFR6A | |
| FR7MPP10 | PLFR6A | |
| FR7NI33 | ILFR6B | |
| FR7NI332S | ILFR6K8 | |
| FR7NPP332 | ILZFR6D11 | |
| FR7SI30 | ILZFR6C-11K | |
| FR8DC | BKR5ES | V-Line No. 35 |
| FR8DC+ | BKR5ES | V-Line No. 35 |
| FR8DC0 | BKR5ES | V-Line No. 35 |
| FR8DCX | BKR5ES-11 | V-Line No. 33 |
| FR8DCX+ | BKR5ES-11 | V-Line No. 33 |
| FR8DE | BKR5ES | V-Line No. 35 |
| FR8DPP33 | IFR5D10 | |
| FR8DPP33+ | IFR5D10 | |
| FR8DS | BKR5EVX | |
| FR8DX | BKR5ES-11 | V-Line No. 33 |
| FR8HDC | BKR5EKB-11 | |
| FR8HDC+ | BKR5EKB-11 | |
| FR8KCU | BKR5EYA-11 | V-Line No. 39 |
| FR8KDC | BKR5EK | V-Line No. 23 |
| FR8LCX | ZFR6F-11 | |
| FR8LDC | BKR5EK | V-Line No. 23 |
| FR8LDC4 | BKR5EK | V-Line No. 23 |
| FR8LTC | BKUR5ET-10 | |
| FR8ME | LFR5B | |
| FR8SPP332 | ILFR5B11 | |
| FR9DC | BKR5ES | V-Line No. 35 |
| FR9DCX | BCPR4ES-11 | |
| FR9HC | ZFR4F-11 | |
| H10BC | BP4FS | |
| H10C | BP4FS | |
| H2CS | B9EFS | |
| H3CS | B8EFS | |
| H5DC | BP7EFS | |
| H5DC0 | BP7EFS | |
| H6BC | BP6FS | |
| H6DC | BP6EFS | V-Line No. 5 |
| H6DC0 | BP6EFS | V-Line No. 5 |
| H7CC | BR6EF | |
| H7DC | BP6EFS | V-Line No. 5 |
| H7DC0 | BP6EFS | V-Line No. 5 |
| H7DCY | BP6EFS-13 | |
| H8BC | BP5FS | |
| H8DC | BP5EFS | |
| H8DC0 | BP5EFS | |
| H8DCX | BP5EFS-13 | |



| BOSCH | → NGK Typ | V-LINE |
|--------------|------------------|---------------|
| H9BC | BP4FS | |
| H9BCY | BPR4FS-15 | |
| H9DC | BP5EFS | |
| H9DC0 | BP5EFS | |
| HGR6KQC | BUR6EFSZ | |
| HGR7KQC | BUR6EFSZ | |
| HLR8STEX | LTR6B-10T | |
| HR10AC | BR5FS | |
| HR10ACY | BR5FS | |
| HR10BC | BPR4FS | |
| HR10BCX | BPR4FS-11 | |
| HR10BCY | BPR4FS-15 | |
| HR6BC | BPR6FS | |
| HR6DC | BPR6EFS | V-Line No. 7 |
| HR6DC+ | BPR6EFS | V-Line No. 7 |
| HR6DS | BPR6EFS | V-Line No. 7 |
| HR7DC | BPR6EFS | V-Line No. 7 |
| HR7DC+ | BPR6EFS | V-Line No. 7 |
| HR7DCX | BPR6EFS | V-Line No. 7 |
| HR7DCX+ | BPR6EFS | V-Line No. 7 |
| HR7DCY | BPR6EFS-15 | |
| HR7DCY+ | BPR6EFS-15 | |
| HR7MPP+ | PTR5A-13 | V-Line No. 25 |
| HR7MPP302 | PTR5A-13 | V-Line No. 25 |
| HR8AC | BR5FS | |
| HR8ACY | BR5FS | |
| HR8BC | BPR5FS | |
| HR8BCY | BPR5FS-15 | |
| HR8DC+ | BPR5EFS | |
| HR8DPP22U | PTR5D-10 | V-Line No. 31 |
| HR8LC0 | TR5-1 | |
| HR8MCV+ | PTR5A-13 | V-Line No. 25 |
| HR8MEV | TR5B-13 | |
| HR9AC | BR5FS | |
| HR9ACY | BR5FS | |
| HR9BC | BPR4FS | |
| HR9BC+ | BPR4FS | |
| HR9BCY | BPR4FS-15 | |
| HR9BCY+ | BPR4FS-15 | |
| HR9DC | BPR5EFS | |
| HR9DCX | BPR5EFS-13 | |
| M12B | AP5FS | |
| VR8SE | LZKAR7A | |
| VR8SEW | LZKAR7A | |
| W06CS | B11EGV | |
| W07CS | B10EGV | |
| W08CS | B10EGV | |
| W3DP2 | BP8ES | |
| W5BC | BP7HS | |
| W5CCX | B7ES-11 | |
| W5DC | BP7ES | |
| W5DC0 | BP7ES | |

| BOSCH | → NGK Typ | V-LINE |
|--------------|------------------|---------------|
| W5DCX | BP7ES-11 | |
| W5DTC | BP6ET | V-Line No. 1 |
| W6BC | BP6HS | V-Line No. 18 |
| W6DC | BP6ES | V-Line No. 4 |
| W6DC0 | BP6ESZ | |
| W6DCX | BP6ES-11 | |
| W6DTC | BP6ET | V-Line No. 1 |
| W6LTCR | BUR6ET | V-Line No. 1 |
| W7BC | BP6HS | V-Line No. 18 |
| W7CCX | B6ES-11 | |
| W7DC | BP6ES | V-Line No. 4 |
| W7DC0 | BP6ESZ | |
| W7DCR | BPR6ES | V-Line No. 2 |
| W7DCX | BP6ES-11 | |
| W7DTC | BP6ET | V-Line No. 1 |
| W7DX | BP6ES-11 | |
| W7LTCR | BUR6ET | V-Line No. 1 |
| W8AC | B5HS | |
| W8BC | BP5HS | |
| W8DC | BP5ES | V-Line No. 8 |
| W8DC0 | BP5ES | V-Line No. 8 |
| W8DCX | BP5ES-11 | |
| W8DCY | BP5ES-13 | |
| W8DTC | BP5ET | |
| W8DTC | BP5ET-10 | |
| W8LCR | ZGR5A | V-Line No. 15 |
| W8LDCR | BUR6ET | V-Line No. 1 |
| W8LTCR | BUR5ET | V-Line No. 22 |
| W8LTCR | BUR5ET-10 | V-Line No. 21 |
| W9AC | B5HS | |
| W9AC0 | B5HS | |
| W9DC | BP5ES | V-Line No. 8 |
| W9DC0 | BP5ES | V-Line No. 8 |
| W9DCX | BP5ES-11 | |
| W9DTC | BP5ET | |
| W9LC | ZGR5A | V-Line No. 15 |
| WR10LC | ZGR5B | |
| WR10LCV | BPR4ES-13 | |
| WR3CTC | BR9ET | |
| WR5DC | BPR7ES | V-Line No. 19 |
| WR5DC+ | BPR7ES | V-Line No. 19 |
| WR5DS | BPR7EIX | |
| WR6BC | BPR6HS | V-Line No. 3 |
| WR6DC | BPR6ES | V-Line No. 2 |
| WR6DC+ | BPR6ES | V-Line No. 2 |
| WR6DCX | BPR6ES-11 | V-Line No. 13 |
| WR6DS | BPR6EVX | |
| WR6DTC | BUR6ET | V-Line No. 1 |
| WR7BC | BPR6HS | V-Line No. 3 |
| WR7BC+ | BPR6HS | V-Line No. 3 |
| WR7CC | BR6ES | |
| WR7CCX | BR6ES-11 | |



| BOSCH | → NGK Typ | V-LINE |
|--------------|------------------|---------------|
| WR7DC | BPR6ES | V-Line No. 2 |
| WR7DC+ | BPR6ES | V-Line No. 2 |
| WR7DC2 | BPR6ES | V-Line No. 2 |
| WR7DCX | BPR6ES-11 | V-Line No. 13 |
| WR7DCX+ | BPR6ES-11 | V-Line No. 13 |
| WR7DS | BPR6EVX | |
| WR7DTC | BUR6ET | V-Line No. 1 |
| WR7LTC+ | BUR6ET | V-Line No. 1 |
| WR8BC | BPR5HS | |
| WR8BC+ | BPR5HS | |
| WR8CC | BR5ES | |
| WR8DC | BPR5ES | V-Line No. 6 |
| WR8DC+ | BPR5ES | V-Line No. 6 |
| WR8DC0 | BPR5ES | V-Line No. 6 |
| WR8DC4 | BPR5ES | V-Line No. 6 |
| WR8DCX | BPR5ES-11 | |
| WR8DCX+ | BPR5ES-11 | |
| WR8DS | BPR5EIX | |
| WR8HP | ZGR5C | |
| WR8LC+ | ZGR5A | V-Line No. 15 |
| WR8LTC+ | BUR5ET-10 | V-Line No. 21 |
| WR9CC | BR5ES | |
| WR9DC | BPR5ES | V-Line No. 6 |
| WR9DC+ | BPR5ES | V-Line No. 6 |
| WR9DCX | BPR5ES-11 | |
| WR9DCX+ | BPR5ES-11 | |
| WR9DCY | BPR5ES-13 | |
| WR9DS | BPR5EIX | |
| WR9HC | ZGR5C | |
| WR9LC | ZGR5A | V-Line No. 15 |
| WR9LS | ZGR5A | V-Line No. 15 |
| YR5LDE | DCPR8EKC | |
| YR6LDE | DCPR8EKC | |
| YR7DE | DCPR8E-N | |
| YR7MPP33 | PLKR7A | |
| BRISK | → NGK Typ | V-LINE |
| D12YC | BCP7ES | |
| D14Y | BCP7ES | |
| D14YC | BCP7ES | |
| D15Y | BCP6ES | V-Line No. 17 |
| D15YC | BCP6ES | V-Line No. 17 |
| D17Y | BCP5ES | V-Line No. 16 |
| D17YC | BCP5ES | V-Line No. 16 |
| DR12YC | BKR7E | |
| DR14YC | BKR7E | |
| DR14ZC | ZFR7F-11 | |
| DR14ZC1 | BCPR7ES-11 | |
| DR15TC | BKUR5ET-10 | |
| DR15YC | BKR6ES | V-Line No. 28 |
| DR15Z | BKR6ES | V-Line No. 28 |
| DR15Z1 | BKR6ES-11 | V-Line No. 14 |

| BRISK | → NGK Typ | V-LINE |
|--------------------------------|------------------|---------------|
| DR17YC | BKR5ES | V-Line No. 35 |
| F14YC | AP7FS | |
| F15YC | AP6FS | |
| FR14YC | APR6FS | |
| FR15YC | APR6FS | |
| G12YC | BP7EFS | |
| G14Y | BP7EFS | |
| G14YC | BP7EFS | |
| G15Y | BP6EFS | V-Line No. 5 |
| G15YC | BP6EFS | V-Line No. 5 |
| G17Y | BP5EFS | |
| G17YC | BP5EFS | |
| GR15YC | BPR6EFS | V-Line No. 7 |
| GR17YC | BPR5EFS | |
| L08JW | B10EGV | |
| L08W | B11EGV | |
| L10JW | B8EGV | |
| L12Y | BP8ES | |
| L12YC | BP8ES | |
| L14Y | BP7ES | |
| L14YC | BP7ES | |
| L15Y | BP6ES | V-Line No. 4 |
| L15YC | BP6ES | V-Line No. 4 |
| L17Y | BP5ES | V-Line No. 8 |
| L17YC | BP5ES | V-Line No. 8 |
| L19 | B4E | |
| LR14TXS | BUR6ET | V-Line No. 1 |
| LR14YC | BPR7ES | V-Line No. 19 |
| LR14ZC | BPR7ES | V-Line No. 19 |
| LR14ZC1 | BPR7ES-11 | |
| LR15TXS | BP6ET | V-Line No. 1 |
| LR15YC | BPR6ES | V-Line No. 2 |
| LR15Z | BPR6ES | V-Line No. 2 |
| LR15Z1 | BPR6ES-11 | V-Line No. 13 |
| LR17YC | BPR5ES | V-Line No. 6 |
| N14Y | BP7HS | |
| N14YC | BP7HS | |
| N15Y | BP6HS | V-Line No. 18 |
| N15YC | BP6HS | V-Line No. 18 |
| N17Y | BP5HS | |
| N17YC | BP5HS | |
| N19 | B5HS | |
| N19C | B5HS | |
| NR15YC | BPR6HS | V-Line No. 3 |
| BUICK => siehe GM | | |
| CADILLAC => siehe GM | | |
| CHAMPION | → NGK Typ | V-LINE |
| 2301 | BPR5ES-11 | |
| 2322 | BPR4ES-11 | |



| CHAMPION | → NGK Typ | V-LINE |
|-----------------|------------------|---------------|
| 2332 | BPR6ES | V-Line No. 2 |
| 2338 | BKR6ES | V-Line No. 28 |
| 2415 | BPR5ES | V-Line No. 6 |
| 2430 | BKR5E-11 | V-Line No. 33 |
| 3071 | BKR5EVX-11 | |
| 3322 | BPR5EIX-11 | |
| 3344 | BKR6EVX-11 | |
| 3407 | TR5-1IX | |
| 860 | A6FS | |
| 9179100 | PFR6G | |
| 9202064 | BKR6EKUB | |
| A50R | R2525-11 | |
| A51R | R2525-10 | |
| A53C | R2525-11 | |
| A53R | R2525-11 | |
| A55C | R2525-10 | |
| A55R | R2525-10 | |
| A55V | R2349-11 | |
| A57CST | R2525-10 | |
| A57G | R2525-10 | |
| A59GC | DCPR9EVX | |
| BL11Y | BP5FS | |
| BL13Y | BP5FS | |
| BL4 | B7FS | |
| BL5 | B7FS | |
| BL7Y | BP7FS | |
| BL9Y | BP6FS | |
| BN12Y | BP5EFS | |
| BN2 | B9EFS | |
| BN6Y | BP7EFS | |
| BN7Y | BP6EFS | V-Line No. 5 |
| BN89Y | BP6EFS | V-Line No. 5 |
| BN9Y | BP6EFS | V-Line No. 5 |
| C10YCC | BCP6ES | V-Line No. 17 |
| C11YCC | BCP5ES | V-Line No. 16 |
| C12YCC | BK5E | |
| C281YC | BCP6ES | V-Line No. 17 |
| C55 | R7436-10 | |
| C55R | R7436-10 | |
| C57 | R7436-9 | |
| C57A | R7436-10 | |
| C57C | R7436-9 | |
| C57CX | R7434-10 | |
| C57JC4 | R7436-10 | |
| C57YCST | R7436-9 | |
| C59 | R7436-9 | |
| C59C | R7436-9 | |
| C61 | R7436-8 | |
| C6BYC | BCP7ET | |
| C6VPYC | BKR7EVX-11 | |
| C6YCC | BCP7ES | |
| C7Y | BCP7ES | |

| CHAMPION | → NGK Typ | V-LINE |
|-----------------|------------------|---------------|
| C7YC | BCP7ES | |
| C7YCC | BCP7ES | |
| C7YCX | BCP7ES | |
| C9MCC | ZFR5F | |
| C9Y | BCP6ES | V-Line No. 17 |
| C9YC | BCP6ES | V-Line No. 17 |
| C9YCC | BCP6ES | V-Line No. 17 |
| C9YCX | BCP6ES | V-Line No. 17 |
| EON1 | BKR6ES | V-Line No. 28 |
| EON2 | BKR5ES | V-Line No. 35 |
| EON3 | BPR5EFS | |
| EON4 | TR5A-10 | |
| EON5 | BPR6ES | V-Line No. 2 |
| EON6 | BPR5ES | V-Line No. 6 |
| F10 | A6FS | |
| F10C | A6FS | |
| F11Y | AP5FS | |
| F11YC | AP5FS | |
| F14Y | AP5FS | |
| F62Y | AP8FS | |
| F7Y | AP7FS | |
| F7YC | AP7FS | |
| F7YCC | AP7FS | |
| F81Y | AP8FS | |
| F82 | A8FS | |
| F83Y | AP8FS | |
| F9Y | AP6FS | |
| F9YC | AP6FS | |
| FN507Y | BCP7ES | |
| G54V | R0045J-10 | |
| G56R | R0373A-10 | |
| J2J | B9S | |
| L12Y | BP5HS | |
| L288 | B5HS | |
| L64Y | BP7HS | |
| L66Y | BP6HS | V-Line No. 18 |
| L81Y | BP7HS | |
| L82Y | BP6HS | V-Line No. 18 |
| L82YC | BP6HS | V-Line No. 18 |
| L82YCC | BP6HS | V-Line No. 18 |
| L85Y | BP6HS | V-Line No. 18 |
| L87Y | BP6HS | V-Line No. 18 |
| L87YC | BP6HS | V-Line No. 18 |
| L87YCC | BP6HS | V-Line No. 18 |
| L89CM | BP5HS | |
| L90 | B5HS | |
| L90C | B5HS | |
| L92Y | BP5HS | |
| L92YC | BP5HS | |
| N10PY | BP6EVX | |
| N10Y | BP6ES | V-Line No. 4 |
| N10Y4 | BP6ES-11 | |



| CHAMPION | → NGK Typ | V-LINE |
|-----------------|------------------|---------------|
| N10YC | BP5ES | V-Line No. 8 |
| N11Y | BP5ES | V-Line No. 8 |
| N11YC | BP5ES | V-Line No. 8 |
| N11YC4 | BP5ES-11 | |
| N11YCC | BP5ES | V-Line No. 8 |
| N12Y | BP5ES | V-Line No. 8 |
| N12YC | BP5ES | V-Line No. 8 |
| N12YCC | BP5ES | V-Line No. 8 |
| N13L | ZGR5C | |
| N13Y | BP5ES | V-Line No. 8 |
| N14LY | ZGR5C | |
| N14Y | BP5ES | V-Line No. 8 |
| N178B | BR8EM | |
| N180B | B7EM | |
| N279YC | BP7ES | |
| N281YC | BP6ES | V-Line No. 4 |
| N4YC | BP9ES | |
| N55G | B105EGV | |
| N56R | B105EGP | |
| N57G | B105EGV | |
| N59G | B95EGV | |
| N5G | B6EVX | |
| N60Y | BPR10EVX | |
| N63Y | BP9ES | |
| N64Y | BP8ES | |
| N65Y | BP7ES | |
| N66Y | BP6ES | V-Line No. 4 |
| N6BYC | BP6ET | V-Line No. 1 |
| N6Y | BP8ES | |
| N6YC | BP8ES | |
| N6YCC | BP8ES | |
| N74C | BUR6EB-11 | |
| N79Y | BP6ES | V-Line No. 4 |
| N7BMC | BP6ET | V-Line No. 1 |
| N7BYC | BP6ET | V-Line No. 1 |
| N7Y | BP7ES | |
| N7YC | BP7ES | |
| N7YCC | BP7ES | |
| N7YCX | BP7ES | |
| N80G | B11EGV | |
| N82G | B105EGV | |
| N84G | B95EGV | |
| N86G | B9EGV | |
| N87G | B8EGV | |
| N89GY | BP6ES | V-Line No. 4 |
| N89Y | BP5ES | V-Line No. 8 |
| N8GY | BP6EVX | |
| N8L | ZGR5C | |
| N8Y | BP6ES | V-Line No. 4 |
| N9BMC | BPR5EKU | |
| N9BYC | BP6ET | V-Line No. 1 |
| N9BYC4 | BP5ET-10 | |

| CHAMPION | → NGK Typ | V-LINE |
|-----------------|------------------|---------------|
| N9Y | BP6ES | V-Line No. 4 |
| N9YC | BP6ES | V-Line No. 4 |
| N9YC4 | BP6ES-11 | |
| N9YCC | BP6ES | V-Line No. 4 |
| N9YCE | BP5ES | V-Line No. 8 |
| N9YCX | BP6ES | V-Line No. 4 |
| OBL9Y | BPR6FS | |
| OE001/R04 | BP6ES | V-Line No. 4 |
| OE001/T10 | BP6ES | V-Line No. 4 |
| OE002/R04 | BKR6ES | V-Line No. 28 |
| OE002/T10 | BKR6ES | V-Line No. 28 |
| OE003/T10 | BCP6ES | V-Line No. 17 |
| OE004/R04 | BPR6ES | V-Line No. 2 |
| OE004/T10 | BPR6ES | V-Line No. 2 |
| OE005/R04 | BKR6ES | V-Line No. 28 |
| OE005/T10 | BKR6ES | V-Line No. 28 |
| OE006/R04 | BPR6ES | V-Line No. 2 |
| OE006/T10 | BPR6ES | V-Line No. 2 |
| OE007/T10 | BP6HS | V-Line No. 18 |
| OE008/R04 | BPR7ES | V-Line No. 19 |
| OE008/T10 | BPR7ES | V-Line No. 19 |
| OE009/R04 | BP7EFS | |
| OE009/T10 | BP7EFS | |
| OE010/R04 | BP7ES | |
| OE010/T10 | BP7ES | |
| OE011/R04 | BPR6EFS | V-Line No. 7 |
| OE011/T10 | BPR6EFS | V-Line No. 7 |
| OE012/R04 | BP6ET | V-Line No. 1 |
| OE012/T10 | BP6ET | V-Line No. 1 |
| OE013/T10 | BKR5ES | V-Line No. 35 |
| OE014/R04 | BCPR7ES | |
| OE014/T10 | BCPR7ES | |
| OE015/T10 | BP5ES | V-Line No. 8 |
| OE016/R04 | BKR6ES | V-Line No. 28 |
| OE016/T10 | BKR6ES | V-Line No. 28 |
| OE017/T10 | BCP7ES | |
| OE018/R04 | BPR7ES | V-Line No. 19 |
| OE018/T10 | BPR7ES | V-Line No. 19 |
| OE019/R04 | BKR5EK | V-Line No. 23 |
| OE019/T10 | BKR5EK | V-Line No. 23 |
| OE020/R04 | BPR6EFS | V-Line No. 7 |
| OE020/T10 | BPR6EFS | V-Line No. 7 |
| OE021/R04 | BCPR6ET | |
| OE021/T10 | BCPR6ET | |
| OE022/T10 | BP6ES | V-Line No. 4 |
| OE023/R04 | BCP6ES | V-Line No. 17 |
| OE023/T10 | BCP6ES | V-Line No. 17 |
| OE025/R04 | BUR6ET | V-Line No. 1 |
| OE025/T10 | BUR6ET | V-Line No. 1 |
| OE026/R04 | BKR6EK | V-Line No. 20 |
| OE026/T10 | BKR6EK | V-Line No. 20 |
| OE027/R04 | BUR5ET-10 | V-Line No. 21 |



| CHAMPION | → NGK Typ | V-LINE |
|-----------------|------------------|---------------|
| OE027/T10 | BUR5ET-10 | V-Line No. 21 |
| OE028/R04 | BP5ET-10 | |
| OE028/T10 | BP5ET-10 | |
| OE030/T10 | BKR6EKC | V-Line No. 26 |
| OE031/R04 | PTR5A-13 | V-Line No. 25 |
| OE031/T10 | PTR5A-13 | V-Line No. 25 |
| OE032/R04 | BKUR6ET-10 | V-Line No. 24 |
| OE032/T10 | BKUR6ET-10 | V-Line No. 24 |
| OE033/T10 | BKR6EZ | V-Line No. 38 |
| OE034/T10 | BKR6ES | V-Line No. 28 |
| OE035/T10 | LFR5B | |
| OE036/R04 | BP7EFS | |
| OE036/T110 | BP7EFS | |
| OE038/T10 | BP6HS | V-Line No. 18 |
| OE039/T10 | BKR6ES-11 | V-Line No. 14 |
| OE041/T10 | ZFR5F | |
| OE042/T10 | BPR5ES | V-Line No. 6 |
| OE043/R04 | BCPR7ES | |
| OE043/T10 | BCPR7ES | |
| OE044/T10 | BP6ET | V-Line No. 1 |
| OE045/T10 | BPR5ES | V-Line No. 6 |
| OE046/T10 | BP7ES | |
| OE048/R04 | BPR6ES-11 | V-Line No. 13 |
| OE048/T10 | BPR6ES-11 | V-Line No. 13 |
| OE049/T10 | BPR5ES-11 | |
| OE050/R04 | BP7EFS | |
| OE050/T10 | BP7EFS | |
| OE051/T10 | BPR5ES | V-Line No. 6 |
| OE054/T10 | APR6FS | |
| OE055/T10 | BP5ES | V-Line No. 8 |
| OE056/R04 | BKR7ES-11 | |
| OE056/T10 | BKR7ES-11 | |
| OE057/T10 | BCP5ES | V-Line No. 16 |
| OE058/T10 | BCP7ES | |
| OE059/T10 | BP5HS | |
| OE060/T10 | ZGR5B | |
| OE061/T10 | AP7FS | |
| OE063/T10 | BKR6ES-11 | V-Line No. 14 |
| OE064/R04 | BPR6HS | V-Line No. 3 |
| OE064/T10 | BPR6HS | V-Line No. 3 |
| OE065/T10 | BP5ES | V-Line No. 8 |
| OE067/T10 | BP7EFS | |
| OE070/T10 | BP6HS | V-Line No. 18 |
| OE072/T10 | BPR5EFS | |
| OE073/T10 | DCPR9E | |
| OE075/T10 | BCP7ES | |
| OE076/T10 | BCP7ET | |
| OE077/T10 | BCPR6ET | |
| OE080/T10 | BKR7ES-11 | |
| OE083/T10 | DCPR8E | |
| OE084/R04 | BP8ES | |
| OE084/T10 | BP8ES | |

| CHAMPION | → NGK Typ | V-LINE |
|-----------------|------------------|---------------|
| OE085/T10 | BKR5EKU | |
| OE087/R04 | BP8ES | |
| OE087/T10 | BP8ES | |
| OE090/T10 | BP7EFS | |
| OE093/T10 | BKR5EZ | V-Line No. 36 |
| OE095/R04 | BP6ET | V-Line No. 1 |
| OE095/T10 | BP6ET | V-Line No. 1 |
| OE099/T10 | BPR5EFS | |
| OE100/T10 | BPR5EKU | |
| OE103/T10 | DCPR9EVX | |
| OE104/T10 | BP6HS | V-Line No. 18 |
| OE105/T10 | GR4 | |
| OE106/T10 | BP5ES | V-Line No. 8 |
| OE109/T10 | BP6ET | V-Line No. 1 |
| OE110/T10 | BCPR7ES | |
| OE122/T10 | PMR7A | |
| OE124/T10 | PFR5J-11 | |
| OE129/T10 | BKR7EVX-11 | |
| OE130/T10 | LZKAR7A | |
| OE134/T10 | PFR5J-11 | |
| OE136/T10 | PFR6J-11 | |
| OE141/T10 | BKR6EVX | |
| OE143/T10 | PFR6G-9 | |
| OE144/T10 | BKUR6ET-10 | V-Line No. 24 |
| OE145/T10 | BKUR6ET-10 | V-Line No. 24 |
| OE146/T10 | PFR5G-13E | |
| OE151/T06 | BPR5EFS | |
| OE152/T10 | BKR5E-11 | V-Line No. 33 |
| OE155/T10 | APR6FS | |
| OE156/T10 | ZGR5C | |
| OE160/T06 | ZFR4F-11 | |
| OE161/T10 | GR4 | |
| OE162/T06 | BR6ES | |
| OE163/T04 | LZTR4A-11 | |
| OE165/T04 | R7436-9 | |
| OE169/T04 | R5724-9 | |
| OE171/T04 | BPR6FS | |
| OE173/T04 | R2525-10 | |
| OE175/T10 | LFR5AP-11 | |
| OE197/T10 | PLKR7A | |
| ON11Y | BP5ES | V-Line No. 8 |
| ON12Y | BP5ES | V-Line No. 8 |
| PG2PHP | PMR8A | |
| PG4PHP | PMR7A | |
| PL9YC | BP6HS | V-Line No. 18 |
| Q504V | R2349-10 | |
| QC12YC | BKR5ES | V-Line No. 35 |
| QC501V | R7434-10 | |
| QC9MC4 | ZFR6F-11 | |
| QL81Y | BPZ7HS10 | |
| QL82YC | BPR6HS | V-Line No. 3 |
| QL87YC | BPR6HS | V-Line No. 3 |



| CHAMPION | → NGK Typ | V-LINE |
|-----------------|------------------|---------------|
| R54G | R2525-10 | |
| RA4HCC | DCPR8E | |
| RA4HCX | DCPR9EVX | |
| RA59GC | DCPR9EVX | |
| RA59PP | DCPR9EIX | |
| RA8GHC | DCPR6E | |
| RA8HC | DCPR7E | |
| RBL11Y | BPR5FS | |
| RBL11Y6 | BPR5FS-15 | |
| RBL12 | BR5FS | |
| RBL126 | BR5FS | |
| RBL13Y | BPR5FS | |
| RBL13Y6 | BPR5FS-15 | |
| RBL15Y | BPR4FS | |
| RBL15Y4 | BPR4FS-11 | |
| RBL15Y6 | BPR4FS-15 | |
| RBL16Y | BPR4FS | |
| RBL17Y | BPR4FS | |
| RBL17Y6 | BPR4FS-15 | |
| RBL9Y | BPR6FS | |
| RBN12Y | BPR5EFS | |
| RBN13Y | BPR5EFS | |
| RBN14Y | BPR5EFS | |
| RBN9Y | BPR6EFS | V-Line No. 7 |
| RC10DMC | BKR5EK | V-Line No. 23 |
| RC10ECC | ZFR6F-11 | |
| RC10PYP4 | PFR5J-11 | |
| RC10PYPB4 | PFR5G-11 | |
| RC10YC | BKR5E | V-Line No. 35 |
| RC10YC4 | BKR6ES-11 | V-Line No. 14 |
| RC10YCC | BKR6ES | V-Line No. 28 |
| RC10YCL | BKR5EZ | V-Line No. 36 |
| RC11LCC4 | BRE527Y-11 | |
| RC11PYPB4 | PFR5G-11 | |
| RC12ECC | ZFR5N | |
| RC12LYC | ZFR5F | |
| RC12MC4 | PZFR5F-11 | |
| RC12MC5 | ZFR5F-11 | |
| RC12MCC4 | ZFR5F-11 | |
| RC12PEC5 | ZFR5LP-13G | |
| RC12PYP | PFR5J-11 | |
| RC12YC | BKR5ES | V-Line No. 35 |
| RC12YC5 | FR45 | |
| RC14ES | ZFR5LP-13G | |
| RC14YC | BKR5ES | V-Line No. 35 |
| RC14YC4 | BKR5E-11 | V-Line No. 33 |
| RC503C | R7433-8 | |
| RC6VPYC | BKR7EVX-11 | |
| RC6YC | BCPR7ES | |
| RC6YCC | BCPR7ES | |
| RC7BMC | BCPR6ET | |
| RC7BYC4 | BCPR6ET | |

| CHAMPION | → NGK Typ | V-LINE |
|-----------------|------------------|---------------|
| RC7GYC | BKR7EVX-11 | |
| RC7GYG | BKR6EVX | |
| RC7PYCB4 | FR6AP10 | |
| RC7Y | BCPR7ES | |
| RC7YC | BCPR7ES | |
| RC7YC4 | BKR7ES-11 | |
| RC7YCC | BCPR7ES | |
| RC7YCC4 | BKR7ES-11 | |
| RC87PYC | BKUR6ET-10 | V-Line No. 24 |
| RC87YC | BKR6ES | V-Line No. 28 |
| RC87YCC | BKR6EZ | V-Line No. 38 |
| RC87YCL | BKR6EZ | V-Line No. 38 |
| RC89PYC | BKUR5ET-10 | |
| RC89TMC | BKUR5ET-10 | |
| RC89YCC | BKR5EZ | V-Line No. 36 |
| RC8BYC | BKR6EKC | V-Line No. 26 |
| RC8DMC | BKR6EK | V-Line No. 20 |
| RC8PYCB | PFR6G-9 | |
| RC8PYP | PFR6J-11 | |
| RC8PYP4 | PFR6G-11 | |
| RC8PYPB4 | PFR5G-13E | |
| RC8VTYC4 | BKUR5ET | V-Line No. 29 |
| RC8YC | BKR5E | V-Line No. 35 |
| RC8YC4 | BKR5E-11 | V-Line No. 33 |
| RC8YCC | BKR6ES | V-Line No. 28 |
| RC8YCL | BKR6ES | V-Line No. 28 |
| RC9BMC | BKR5EKU | |
| RC9MC4 | ZFR5F-11 | |
| RC9MCC4 | ZFR6F-11 | |
| RC9TMC | BKR6EKUB | |
| RC9YC | BKR6ES | V-Line No. 28 |
| RC9YC4 | BKR6ES-11 | V-Line No. 14 |
| RC9YC5 | BKR6E-11 | V-Line No. 14 |
| RC9YCC | BKR6ES | V-Line No. 28 |
| RC9YCC4 | BKR6E-11 | V-Line No. 14 |
| RC9YCN4 | BKR6E-11 | V-Line No. 14 |
| RE10LC | TR5-1IX | |
| RE10PMC5 | PTR5A-13 | V-Line No. 25 |
| RE14MCC5 | LZTR4A-11 | |
| RE14PLP5 | PLZTR5A-13 | |
| RE7PYC5 | PTR5A-13 | V-Line No. 25 |
| RE7YCC | PTR5A-13 | V-Line No. 25 |
| REA8MCL | LZKAR7A | |
| REC10PYC4 | LFR5AP-11 | |
| REC9MCLX | LFR5B | |
| REC9YCL | LFR5B | |
| RER8YC | PLKR7A | |
| RES9YCC4 | PTR5A-13 | V-Line No. 25 |
| RF10 | AR6FS | |
| RF10C | AR6FS | |
| RF11Y | APR6FS | |
| RF11YC | APR6FS | |



| CHAMPION | → NGK Typ | V-LINE |
|-----------------|------------------|---------------|
| RF14Y | APR5FS | |
| RF7YC | APR6FS | |
| RF7YCC | APR6FS | |
| RF9Y | APR6FS | |
| RF9Y5 | APR6FS | |
| RF9YC | APR6FS | |
| RFN14LY | ZFR4F-11 | |
| RG4PHP | PMR7A | |
| RJ14CC | XR4 | |
| RJ18YC6 | XR45IX | |
| RL12Y | BPR6HS | V-Line No. 3 |
| RL82Y | BPR6HS | V-Line No. 3 |
| RL82YC | BPR6HS | V-Line No. 3 |
| RL82YCC | BPR6HS | V-Line No. 3 |
| RL87Y | BPR6HS | V-Line No. 3 |
| RL87YC | BPR6HS | V-Line No. 3 |
| RL95YC | BPR5HS | |
| RN10GY | BPR6EVX | |
| RN10PYP4 | PGR5A-11 | |
| RN10VTYC | BUR5ET | V-Line No. 22 |
| RN10VTYC4 | BUR5ET-10 | V-Line No. 21 |
| RN10Y | BPR6ES | V-Line No. 2 |
| RN10Y4 | BPR6ES-11 | V-Line No. 13 |
| RN10YC | BPR6ES | V-Line No. 2 |
| RN11Y | BPR5ES | V-Line No. 6 |
| RN11YC | BPR5ES | V-Line No. 6 |
| RN11YC4 | BPR5ES-11 | |
| RN11YCC | BPR5ES | V-Line No. 6 |
| RN12GY | BPR5EIX | |
| RN12MC4 | BPR4EY-11 | |
| RN12Y | BPR5ES | V-Line No. 6 |
| RN12YC | BPR5ES | V-Line No. 6 |
| RN12YC4 | BPR5ES-11 | |
| RN12YC6 | BPR5ES-13 | |
| RN12YCC | BPR5ES | V-Line No. 6 |
| RN13L | ZGR5C | |
| RN13LYC | ZGR5C | |
| RN14LY | ZGR5C | |
| RN14MC5 | BPR4EY-11 | |
| RN14PMP5 | GR4 | |
| RN14Y | BPR5ES | V-Line No. 6 |
| RN14Y6 | BPR5ES-13 | |
| RN14YC | GR4 | |
| RN16Y | BPR4ES | |
| RN16YC5 | BPR4ES-13 | |
| RN16YC6 | BPR4EY-11 | |
| RN180B | BR7EM | |
| RN5 | BR6ES | |
| RN5C | BR6ES | |
| RN6 | BR6ES | |
| RN74C | BUR6EB-11 | |
| RN7GY | BPR7EIX | |

| CHAMPION | → NGK Typ | V-LINE |
|-----------------|------------------|---------------|
| RN7Y | BPR7ES | V-Line No. 19 |
| RN7YC | BPR7ES | V-Line No. 19 |
| RN7YCC | BPR7ES | V-Line No. 19 |
| RN7YCC4 | BPR7ES-11 | |
| RN8 | BR5ES | |
| RN8L | ZGR5C | |
| RN8VTYC4 | BUR6ET | V-Line No. 1 |
| RN9BMC | BPR5EKU | |
| RN9GY | BPR6EVX | |
| RN9LCC | ZGR5B | |
| RN9Y | BPR6ES | V-Line No. 2 |
| RN9YC | BPR6ES | V-Line No. 2 |
| RN9YC4 | BPR6ES-11 | V-Line No. 13 |
| RN9YCC | BPR6ES | V-Line No. 2 |
| RS10LC | TR5-1 | |
| RS12PYP | TR5IX | |
| RS12YC | TR4 | |
| RS12YC6 | BPR5EFS-13 | |
| RS13LYC | TR4 | |
| RS14LC | TR5-1 | |
| RS14LYC | TR4 | |
| RS14PYP | TR4IX | |
| RS14YC | BPR5EFS | |
| RS14YC6 | TR55IX | |
| RS15LYC | TR4 | |
| RS16YC | TR4 | |
| RS5C | BR7EFS | |
| RS9YC | BPR6EFS | V-Line No. 7 |
| RS9YCC | BPR6EFS | V-Line No. 7 |
| RV12C | BR5FS | |
| RV12C6 | BR5FS | |
| RV12YC | BPR5FS | |
| RV12YC6 | BPR5FS-15 | |
| RV15YC | BPR4FS | |
| RV15YC4 | BPR4FS-11 | |
| RV15YC6 | BPR4FS-15 | |
| RV17YC | BPR4FS | |
| RV17YC6 | BPR4FS-15 | |
| RV92YC | BPR5FS | |
| RV9YC | BPR6FS | |
| RZN12Y | BPR5EFS | |
| RZN12Y5 | BPR5EFS | |
| S10YCC | BP5EFS | |
| S12YC | BP5EFS | |
| S279YC | BP6EFS | V-Line No. 5 |
| S281YC | BP6EFS | V-Line No. 5 |
| S379YC | BP7EFS | |
| S59C | R5724-9 | |
| S6YC | BP7EFS | |
| S7YC | BP7EFS | |
| S7YCC | BP7EFS | |
| S9YC | BP6EFS | V-Line No. 5 |



| CHAMPION | → NGK Typ | V-LINE |
|-----------------|------------------|---------------|
| S9YCC | BP6EFS | V-Line No. 5 |
| UF11Y | AP6FS | |
| UF14Y | AP4FS | |
| UF9Y | AP6FS | |
| UL82Y | BP7HS | |
| UN79Y | BP6ES | V-Line No. 4 |
| V12YC | BP5FS | |
| V4C | B7FS | |
| V61 | R5673-8 | |
| V63C | R5673-7 | |
| V9YC | BP6FS | |
| XC92YC | BKR5E | V-Line No. 35 |

CHEVROLET => siehe GM

| CHRYSLER | → NGK Typ | V-LINE |
|-----------------|------------------|---------------|
| 04606 402 AB | LZTR4A-11 | |
| 04606 591 AB | ZFR5LP-13G | |
| 04886 204 | BP5HS | |
| 04886 205 | BP5ES-A | |
| 04886 206 | BP6ES | V-Line No. 4 |
| 04886 207 | BP5FS | |
| 04886 208 | BP4FS | |
| 04886 210 | BP5EFS | |
| 04886 211 | TR4 | |
| 04886 212 | AP4FS | |
| 04886 213 | BPR5ES-11 | |
| 04886 214 | BPR4ES-11 | |
| 04886 215 | BCPR5ES | |
| 04886 217 | BPR5ES-A | |
| 04886 219 | BKR6ES | V-Line No. 28 |
| 04887 030 | ZFR5F-11 | |
| 04887 031 | BKR5ES-11 | V-Line No. 33 |
| 04887 032 | PFR5J-11 | |
| S2LZT R4A 11 | LZTR4A-11 | |

CITROEN => siehe PSA

DACIA => siehe RENAULT

DAEWOO => siehe GM

| DAIHATSU | → NGK Typ | V-LINE |
|-----------------|------------------|---------------|
| 90048-51034-000 | BP6ES | V-Line No. 4 |
| 90048-51034-010 | BP6ES | V-Line No. 4 |
| 90048-51035-000 | BP6EY | |
| 90048-51039-000 | BPR6EK-A | |
| 90048-51040-000 | BP6EK | |
| 90048-51041-000 | BPR6EY | |
| 90048-51044-000 | BPR5EY | V-Line No. 9 |
| 90048-51047-010 | BP5EY | |
| 90048-51048-000 | BPR5EY | V-Line No. 9 |

| DAIHATSU | → NGK Typ | V-LINE |
|-----------------|------------------|---------------|
| 90048-51049-000 | BPR4EY-11 | |
| 90048-51050-000 | BPR5EY-11 | |
| 90048-51053 | BP5EY | |
| 90048-51053-000 | BP5EY | |
| 90048-51054 | BPR5EY | V-Line No. 9 |
| 90048-51054-000 | BPR5EY | V-Line No. 9 |
| 90048-51055-000 | BP6ES | V-Line No. 4 |
| 90048-51058-000 | BE527Y-11 | |
| 90048-51059 | BPR6EY | |
| 90048-51059-000 | BPR6EY | |
| 90048-51062-000 | BPR5EY-11 | |
| 90048-51063 | BPR5EY-11 | |
| 90048-51063-000 | BPR5EY-11 | |
| 90048-51069-000 | BP6EY | |
| 90048-51072-000 | BP5ES | V-Line No. 8 |
| 90048-51073-000 | BPR6EK-A | |
| 90048-51074-000 | BPR6EK-A | |
| 90048-51077-000 | BPR6EKN | |
| 90048-51079-000 | BKR7E-11 | |
| 90048-51081-000 | BPR5EY-11 | |
| 90048-51082-000 | BPR5EY | V-Line No. 9 |
| 90048-51084-000 | BPR7EKN | |
| 90048-51086-000 | BPR6EK-A | |
| 90048-51087-000 | BPR6EK-A | |
| 90048-51091-000 | BPR5EY-11 | |
| 90048-51092-000 | BPR6EY-11 | V-Line No. 10 |
| 90048-51093-000 | BPR5EY-11 | |
| 90048-51093A | BPR5EY-11 | |
| 90048-51095-000 | BPR6ES | V-Line No. 2 |
| 90048-51096-000 | BPR6ES | V-Line No. 2 |
| 90048-51099-000 | BKR6E-11 | V-Line No. 14 |
| 90048-51100 | BKR6E-11 | V-Line No. 14 |
| 90048-51100-000 | BKR6E-11 | V-Line No. 14 |
| 90048-51101-000 | BPR5EY | V-Line No. 9 |
| 90048-51102-000 | BPR6EKN | |
| 90048-51103-000 | BPR7EKN | |
| 90048-51104-000 | BPR6EKN | |
| 90048-51105-000 | BPR7EKN | |
| 90048-51107-000 | BPR6EKB-L | |
| 90048-51108-000 | BPR6EKB-L | |
| 90048-511081 | BPR6EKB-L | |
| 90048-51110-000 | BCPR7EKD | |
| 90048-51111-000 | BCPR6ED | |
| 90048-51112 | BCPR7EKD | |
| 90048-51112-000 | BCPR7EKD | |
| 90048-51113 | BCPR6ED | |
| 90048-51113-000 | BCPR6ED | |
| 90048-51114 | BPR5ES | V-Line No. 6 |
| 90048-51114-000 | BPR5ES | V-Line No. 6 |
| 90048-51115-000 | BPR6EKB-L | |
| 90048-51116 | BPR6EKB | |
| 90048-51116-000 | BPR6EKB | |



| DAIHATSU | → NGK Typ | V-LINE |
|-----------------|------------------|---------------|
| 90048-51117-000 | PFR6B-11 | |
| 90048-51118-000 | PFR6B-11 | |
| 90048-51121-000 | BPR4EY | |
| 90048-51123 | BKR6EY-11 | |
| 90048-51123-000 | BKR6EY-11 | |
| 90048-51125-000 | BPR5EJ | |
| 90048-51126 | BPR5EJ | |
| 90048-51126-000 | BPR5EJ | |
| 90048-51130-000 | BPR5EKB | |
| 90048-51131 | BPR5EKB | |
| 90048-51131-000 | BPR5EKB | |
| 90048-511311 | BPR5EKB | |
| 90048-51133-000 | BCPR6EKD | |
| 90048-51134 | BCPR6EKD | |
| 90048-51134-000 | BCPR6EKD | |
| 90048-511341 | BCPR6EKD | |
| 90048-51136-000 | BKUR6EK | |
| 90048-51137 | BKUR6EK | |
| 90048-51137-000 | BKUR6EK | |
| 90048-51140 | BPR6EKB | |
| 90048-51143-000 | BKUR7EK | |
| 90048-51144 | BKUR7EK | |
| 90048-51144-000 | BKUR7EK | |
| 90048-51145 | BKR4E | |
| 90048-51151-000 | BKR6E | V-Line No. 28 |
| 90048-51152 | BKR6E | V-Line No. 28 |
| 90048-51152-000 | BKR6E | V-Line No. 28 |
| 90048-51154-000 | BKR6EKC | V-Line No. 26 |
| 90048-51155-000 | BKR6EKC | V-Line No. 26 |
| 90048-51156-000 | R7433-9 | |
| 90048-51158-000 | BKR5E-11 | V-Line No. 33 |
| 90048-51158-008 | BKR5E-11 | V-Line No. 33 |
| 90048-51159-000 | BKUR6EK-9 | |
| 90048-51160 | BKUR6EK-9 | |
| 90048-51160-000 | BKUR6EK-9 | |
| 90048-51161 | BKR7E | |
| 90048-51161-000 | BKR7E | |
| 90048-51162 | IFR7F-6D | |
| 90048-51163-000 | BKR6EYA-11 | |
| 90048-51165 | BKR5EKC | |
| 90048-51165-000 | BKR5EKC | |
| 90048-51166 | PFR6G | |
| 90048-51166-000 | PFR6G | |
| 90048-51168 | BKUR6ETB-10 | |
| 90048-51168-000 | BKUR6ETB-10 | |
| 90048-51169-000 | BKUR6ETB-10 | |
| 90048-51173 | IFR6J11 | |
| 90048-51173-000 | IFR6J11 | |
| 90048-51175-000 | BKR6EKPA | |
| 90048-51183-000 | BKUR6E | |
| 90048-51184 | BKUR6E | |
| 90048-51184-000 | BKUR6E | |

| DAIHATSU | → NGK Typ | V-LINE |
|-----------------|------------------|---------------|
| 90048-51185-000 | ILFR6T11 | |
| 90048-51187 | IKR7C | |
| 90048-51192 | LKR7C | |
| 90048-51192-000 | LKR7C | |
| 90048-51194 | IKR7E9 | |
| 90048-51196 | DCPR7EA-9 | |
| 90048-51199 | ILKR7D9 | |
| 90048-51200 | IKR7D | |
| 90919-01026-000 | BP5EY | |
| 90919-01056-000 | BP4EY | |
| 90919-01059-000 | BP5EY | |
| 90919-01060-000 | BP4EY | |
| 90919-01061-000 | BP5EY | |
| 90919-01065-000 | BPR4EY | |
| 90919-01085-000 | BP4EY-11 | |
| 90919-01086-000 | BP4EY-11 | |
| 90919-01087-000 | BP5EK-A | |
| 90919-01106-000 | BP4EY-11 | |
| 90919-01115-000 | BPR5EP-11 | |
| 90919-01116-000 | BPR5EP-11 | |
| 90919-01117-000 | BE529Y-11 | |
| 90919-01118-000 | BE529Y-11 | |
| 90919-01177-000 | BKR5EYA | |
| 90919-01181-000 | BKR6EP-8 | |
| 90919-01202-000 | BKR6EKB-11 | |
| 99906-850P9-006 | BPR6HS | V-Line No. 3 |
| 99906-850P9-011 | BPR5ES-11 | |
| 99906-850P9-012 | BPR6ES-11 | V-Line No. 13 |
| 99906-850P9-013 | BPR5ES-13 | |
| 99906-850P9-015 | BPR5EIX-11 | |
| 99906-850P9-017 | BRE527Y-11 | |
| 99906-850P9-018 | BRE529Y-11 | |
| 99906-910P9-004 | BPR5HS | |
| 99906-910P9-005 | BPR6HS | V-Line No. 3 |
| 99906-910P9-006 | BR5ES | |
| 99906-910P9-007 | BR6ES | |
| 99906-910P9-011 | BPR5ES-11 | |
| 99906-910P9-012 | BPR6ES-11 | V-Line No. 13 |
| 99906-910P9-013 | BPR5EIX-11 | |
| 99906-910P9-015 | BPR4EY-11 | |
| 99906-910P9-017 | BPR6EY-11 | V-Line No. 10 |
| 99906-910P9-020 | BPR6E | V-Line No. 2 |
| 99906-910P9-021 | BCPR5E-11 | |
| 99906-910P9-022 | BCPR5EY-11 | |
| 99906-910P9-023 | BCPR6E-11 | V-Line No. 11 |
| 99906-910P9-024 | BCPR6EY-11 | |
| 99906-910X9-001 | BPR5EIX-11 | |
| 99906-910X9-002 | BPR6EIX-11 | |
| 99906-910X9-003 | BPR7EIX | |
| 99906-910X9-004 | BCPR5EIX-11 | |
| 99906-910X9-005 | BCPR6EIX-11 | |
| 99906-910X9-006 | BKR5EIX-11 | |



| DAIHATSU | → NGK Typ | V-LINE |
|-----------------|------------------|---------------|
| 99906-910X9-007 | BKR6EIX-11 | |
| 99906-910X9-008 | BPR6HIX | |
| 99906-910X9-018 | DCPR7EIX | |
| 99906-910X9-019 | ZFR5FIX-11 | |
| 99906-910X9-020 | ZFR6FIX-11 | |
| 99906-910X9-026 | BPR5EIX | |
| 99906-910X9-027 | BPR6EIX | |
| 99906-910X9-028 | BKR5EIX | |
| 99906-910X9-029 | BKR6EIX | |
| 99906-910X9-030 | BKR7EIX-11 | |
| 99906-910X9-031 | BCPR7EDIX | |
| 99906-910X9-032 | BKR5EIX-P | |
| 99906-910X9-033 | BKR5EIX-11P | |
| 99934-00691-100 | BP6EVX | |
| 99934-01691-100 | BPR5EIX | |
| 99934-02691-100 | B6EVX | |
| 99934-05691-100 | BP5ES-11 | |
| 99934-06691-100 | BP6ES-11 | |
| 99934-07685-100 | BP5EY-11 | |
| 99934-07691-100 | BP5HS | |
| 99934-08685-100 | BP6EY-11 | |
| 99934-08691-100 | BP5ES-13 | |
| 99934-09685-100 | BP6HS | V-Line No. 18 |
| 99934-09691-100 | BP6HS | V-Line No. 18 |
| 99934-10691-100 | BP4EY | |
| 99934-12685-100 | BP5HS | |
| 99934-13685-100 | BP6ES-11 | |
| 99934-14685-100 | BP5ES-13 | |
| NDIK16 | BKR5EIX-11 | |
| NDIK16A | BKR5EIX-11 | |
| NDIK20 | BKR6EIX-11 | |
| NDIK20A | BKR6EIX-11 | |
| NDIQ16 | BCPR5EIX-11 | |
| NDIQ16A | BCPR5EIX-11 | |
| NDIQ20 | BCPR6EIX-11 | |
| NDIQ20A | BCPR6EIX-11 | |
| NDIW16 | BPR5EIX-11 | |
| NDIW16A | BPR5EIX-11 | |
| NDIW20 | BPR6EIX-11 | |
| NDIW20A | BPR6EIX-11 | |
| NDIW22 | BPR7EIX | |
| NDIW22A | BPR7EIX | |
| NDIXU22 | DCPR7EIX | |
| NDIXU22A | DCPR7EIX | |
| NDVK16 | BKR5EIX-11P | |
| NDVK16A | BKR5EIX-11P | |
| NDVQ16 | BCPR5EIX-11P | |
| NDVQ16A | BCPR5EIX-11P | |
| NDVQ20 | BCPR6EIX-11P | |
| NDVQ20A | BCPR6EIX-11P | |

| DENSO | → NGK Typ | V-LINE |
|--------------|------------------|---------------|
| 3004 | BPR5EP-11 | |
| 3005 | BCPR5EIX-11 | |
| 3006 | BCPR5EY-11 | |
| 3009 | BCPR6EY-11 | |
| 3011 | BP4EY | |
| 3013 | BPR4EY | |
| 3018 | BP5ES | V-Line No. 8 |
| 3027 | BP5EY | |
| 3032 | BPR5EY-11 | |
| 3034 | B5HS | |
| 3043 | BP6ES | V-Line No. 4 |
| 3046 | BUR6EA-11 | |
| 3049 | BPR6ES-11 | V-Line No. 13 |
| 3057 | BR6ES | |
| 3062 | BP6EY | |
| 3066 | BPR6EY | |
| 3067 | BPR6EY-11 | V-Line No. 10 |
| 3068 | BP6HS | V-Line No. 18 |
| 3070 | BPR6HS | V-Line No. 3 |
| 3085 | BP7ES | |
| 3088 | BPR7ES | V-Line No. 19 |
| 3089 | BPR7ES-11 | |
| 3103 | BR8ET | |
| 3107 | BR9ET | |
| 3110 | BR5ES | |
| 3111 | SD11A | |
| 3112 | ZFR6A-11 | |
| 3113 | BCPR6EP-N-8 | |
| 3114 | PGR5A-11 | |
| 3115 | PGR6A-11 | |
| 3117 | BCPR6EP-11 | |
| 3119 | BKR5EYA | |
| 3120 | BKR5EYA-11 | V-Line No. 39 |
| 3121 | BKR6E-11 | V-Line No. 14 |
| 3122 | BKR6EYA | |
| 3123 | BCPR5EP-8 | |
| 3125 | BCP6ES | V-Line No. 17 |
| 3127 | BKR6EP-8 | |
| 3128 | BKR6EP-11 | |
| 3129 | BCPR5EY | |
| 3130 | BKR5E-11 | V-Line No. 33 |
| 3131 | ZFR5J-11 | |
| 3132 | ZFR5F-11 | |
| 3133 | ZFR6J-11 | |
| 3134 | BKR5EP-11 | |
| 3135 | ZFR5E-11 | |
| 3139 | BKR6EY-11 | |
| 3140 | BCPR6EY | |
| 3141 | PFR6J-11 | |
| 3142 | PFR6G-11 | |
| 3144 | BKR6E-N-11 | |
| 3156 | BCPR5EIX-11 | |



| DENSO | → NGK Typ | V-LINE |
|--------------|------------------|---------------|
| 3157 | BCPR6EVX-11 | |
| 3158 | BCP7EVX | |
| 3161 | BKR5EVX-11 | |
| 3163 | BKR6EVX-11 | |
| 3165 | BKR7E | |
| 3167 | ZFR4F-11 | |
| 3168 | PFR6B-11 | |
| 3169 | ZFR6F-11 | |
| 3172 | PFR6G-13 | |
| 3174 | PFR5J-11 | |
| 3175 | PZFR5F | |
| 3179 | DCPR7E | |
| 3184 | BCPR5EY-11 | |
| 3186 | BCPR5EY-11 | |
| 3187 | BCPR6EY-11 | |
| 3192 | BKR7E-11 | |
| 3194 | BKR5EKB-11 | |
| 3195 | BKR6EKB-11 | |
| 3196 | BKUR6EK | |
| 3197 | BKUR7EK | |
| 3199 | BP5EY-11 | |
| 3201 | BPR5ES-11 | |
| 3210 | BPR5EY | V-Line No. 9 |
| 3213 | BPR5ES-13 | |
| 3226 | BKR6EP-13 | |
| 3231 | BPR5EIX | |
| 3235 | BCRE527Y | |
| 3239 | BPR5EP-13 | |
| 3242 | DCPR7EVX | |
| 3244 | BCPR6EIX-11 | |
| 3245 | PFR6J | |
| 3246 | PZFR5F-11 | |
| 3247 | PZFR6F-11 | |
| 3253 | BKR6EKP-11 | |
| 3255 | BCP7ES | |
| 3256 | ZGR5A | V-Line No. 15 |
| 3262 | BKR6EVX-11 | |
| 3264 | PFR5B-11 | |
| 3273 | PFR7B | |
| 3275 | PFR5G-11 | |
| 3277 | BPR6EKN | |
| 3281 | BPR7EIX | |
| 3285 | BPR5EIX-11 | |
| 3289 | BKR5EKP-11 | |
| 3290 | BKR7EVX | |
| 3291 | BPR6EVX | |
| 3293 | BKR5EVX | |
| 3297 | IFR6T11 | |
| 3299 | BKR7E-N-11 | |
| 3302 | PGR7A | |
| 3303 | IFR5T-8N | |
| 3304 | BKR6EKC | V-Line No. 26 |

| DENSO | → NGK Typ | V-LINE |
|--------------|------------------|---------------|
| 3305 | BKUR6EK-9 | |
| 3306 | PGR6A | |
| 3307 | IFR6C | |
| 3310 | BR10ET | |
| 3312 | DCPR8E | |
| 3313 | DCPR9E | |
| 3314 | DCPR9EVX | |
| 3323 | BPR6EVX-11 | |
| 3333 | BKR6E | V-Line No. 28 |
| 3344 | BPR6ES | V-Line No. 2 |
| 3345 | BPR5ES | V-Line No. 6 |
| 3346 | BCPR5E | V-Line No. 32 |
| 3347 | BCPR7ES | |
| 3348 | ZFR7F-11 | |
| 3349 | BKR5E | V-Line No. 35 |
| 3353 | BKR5EIX-11P | |
| 3354 | IGR7A | |
| 3372 | IFR7G-11KS | |
| 3373 | BKR6EP-8 | |
| 3374 | ZFR6K-11 | |
| 3377 | IZFR6K11 | |
| 3378 | ZFR6FIX-11 | |
| 3379 | BCPR7ES-11 | |
| 3380 | BKR6EKPA | |
| 3381 | LFR6C-11 | |
| 3396 | IZFR5F11 | |
| 3400 | IFR5E11 | |
| 3403 | IFR6B-K | |
| 3412 | IFR5E11 | |
| 3413 | ZFR5F | |
| 3418 | IFR6E11 | |
| 3424 | BKR6E | V-Line No. 28 |
| 3427 | LZKAR7A | |
| 3432 | IZFR6K-11S | |
| 3434 | IKR7C | |
| 3439 | DILKAR6A11 | |
| 3441 | ILKR7B8 | |
| 3444 | ILKAR7B11 | |
| 3449 | IFR6J11 | |
| 4019 | BP5HS | |
| 4021 | BP7HS | |
| 4028 | BP8ES | |
| 4032 | B8EGV | |
| 4048 | B9EGV | |
| 4057 | B95EGV | |
| 5008 | APR5FS | |
| 5012 | AP6FS | |
| 5013 | APR6FS | |
| 5022 | BPR5EFS | |
| 5027 | BPR5FS-15 | |
| 5031 | BP6EFS | V-Line No. 5 |
| 5032 | BPR6EFS | V-Line No. 7 |



| DENSO | → NGK Typ | V-LINE |
|--------------|------------------|---------------|
| 5035 | BPR6FS | |
| 5040 | BP7EFS | |
| 5060 | BKUR6ET | V-Line No. 27 |
| 5061 | BKUR6ET-10 | V-Line No. 24 |
| 5062 | BKUR7ET | |
| 5063 | BKR6EKUB | |
| 5064 | BP5ET-10 | |
| 5065 | BP6ET | V-Line No. 1 |
| 5066 | BP7ET | |
| 5067 | BUR6ET | V-Line No. 1 |
| 5068 | PTR5A-13 | V-Line No. 25 |
| 5069 | BCP7ET | |
| 5070 | PTR5D-10 | V-Line No. 31 |
| 5077 | PZTR5A-15 | |
| 5301 | BCPR5EIX-11 | |
| 5302 | BCPR6EIX-11 | |
| 5303 | BKR5EIX-11 | |
| 5304 | BKR6EIX-11 | |
| 5305 | BPR5EIX-11 | |
| 5306 | BPR6EIX-11 | |
| 5307 | BPR7EIX | |
| 5308 | DCPR7EIX | |
| 5325 | TR5IX | |
| 5327 | TR7IX | |
| 5328 | TR8IX | |
| 5330 | UR5IX | |
| 5331 | UR6IX | |
| 5343 | LFR5AIX-11 | |
| 5344 | LFR6AIX-11 | |
| 5378 | BPR6HIX | |
| 5601 | BCPR5EIX-11P | |
| 5602 | BCPR6EIX-11P | |
| 5603 | BKR5EIX-11P | |
| 5604 | IZFR6H11 | |
| 5617 | ILZFR5B | |
| 5618 | ILZFR6D11 | |
| 5623 | HB6AIX-11P | |
| 5625 | HB6BIX-11P | |
| FXE20HR11 | DILKAR6A11 | |
| IA0132 | R7282A-105 | |
| IA0134 | R7282A-11 | |
| IAE0132 | R7282-105 | |
| IAE0134 | R7282-11 | |
| IK0124 | R7434-8 | |
| IK0127 | R7434-9 | |
| IK0131 | R7434-10 | |
| IK0224 | R7434-8 | |
| IK0227 | R7434-9 | |
| IK0231 | R7434-10 | |
| IK16 | BKR5EIX-11 | |
| IK20 | BKR6EIX-11 | |
| IKH0124 | R7438-8 | |

| DENSO | → NGK Typ | V-LINE |
|--------------|------------------|---------------|
| IKH0127 | R7438-9 | |
| IKH0131 | R7438-10 | |
| IKH16 | LFR5AIX-11 | |
| IKH20 | LFR6AIX-11 | |
| IQ0124 | R7436-8 | |
| IQ0127 | R7436-9 | |
| IQ0131 | R7436-10 | |
| IQ0224 | R7436-8 | |
| IQ0227 | R7436-9 | |
| IQ0231 | R7436-10 | |
| IQ16 | BCPR5EIX-11 | |
| IQ20 | BCPR6EIX-11 | |
| IRE0134 | R7420-11 | |
| IT16 | TR5IX | |
| IT22 | TR7IX | |
| IT24 | TR8IX | |
| ITF16 | UR5IX | |
| ITF20 | UR6IX | |
| IU0127 | R0373A-9 | |
| IU0131 | R0373A-10 | |
| IU0134 | R0373A-11 | |
| IW0124 | R7376-8 | |
| IW0127 | R7376-9 | |
| IW0131 | R7376-10 | |
| IW0627 | R7376-9 | |
| IW0631 | R7376-10 | |
| IW16 | BPR5EIX-11 | |
| IW20 | BPR6EIX-11 | |
| IW22 | BPR7EIX | |
| IWF20 | BPR6HIX | |
| IWM0132 | R6179A-105P | |
| IX22 | DR7EIX | |
| IXU0127 | R2525-9 | |
| IXU0131 | R2525-10 | |
| IXU0134 | R2349-11 | |
| IXU22 | DCPR7EIX | |
| IXU22C | KR7AI | |
| J16ARU11 | BRE527Y-11 | |
| J16AU11 | BE527Y-11 | |
| J16AY | BPR5EY-11 | |
| J16AYR | BPR5EJ | |
| J16BRU | BRE529Y | |
| J16BRU11 | BRE529Y-11 | |
| J16BU11 | BE529Y-11 | |
| J16CRU | ZGR5A | V-Line No. 15 |
| J16CU | BPR5EY | V-Line No. 9 |
| J20AY | BPR6EY-11 | V-Line No. 10 |
| K14PRU11 | BKR4E-11 | |
| K14PU11 | BKR5E-11 | V-Line No. 33 |
| K16DTRS11 | ZFR5G | |
| K16GPRU11 | ZFR5E-11 | |
| K16PRL11 | BKR5E-N-11 | |



| DENSO | → NGK Typ | V-LINE |
|--------------|------------------|---------------|
| K16PRP11 | BKR5EVX | |
| K16PRTP11 | BKR5EVX-11 | |
| K16PRU | BKR5E | V-Line No. 35 |
| K16PRU11 | BKR5E-11 | V-Line No. 33 |
| K16PRUR | BKR5E | V-Line No. 35 |
| K16PRZU11 | BKR5EVX-11 | |
| K16PU | BK5E | |
| K16PU11 | BK5E-11 | |
| K16RU | BKR5EYA | |
| K16RU11 | BKR5EYA-11 | V-Line No. 39 |
| K16RZU11 | BKR5EVX-11 | |
| K16TNRS9 | BKR5EKC | |
| K16TR11 | BKR5EKB-11 | |
| K16U | BKR5EYA | |
| K16U11 | BKR5EYA-11 | V-Line No. 39 |
| K20DTRS11 | ZFR6G | |
| K20HRU | LFR6B | |
| K20HRU11 | LFR6C-11 | |
| K20PBR | BKUR6ET | V-Line No. 27 |
| K20PBR10 | BKUR6ET-10 | V-Line No. 24 |
| K20PRL11 | BKR6E-N-11 | |
| K20PRSU9 | BKUR6E | |
| K20PRTP11 | BKR6EVX-11 | |
| K20PRU | BKR6E | V-Line No. 28 |
| K20PRU11 | BKR6E-11 | V-Line No. 14 |
| K20PRU9S | BKR6E-9S | |
| K20PRUR | BKR6E | V-Line No. 28 |
| K20PRZU11 | BKR6EVX-11 | |
| K20PSR-B8 | FR6EI | |
| K20PU | BK6E | |
| K20PU11 | BK6E-11 | |
| K20RU | BKR6EYA | |
| K20RU11 | BKR6EY-11 | |
| K20RZ | BKR6EVX | |
| K20RZU11 | BKR6EVX-11 | |
| K20TMR11 | BKR6EKC-N-11 | |
| K20TNR | BKR6EKC | V-Line No. 26 |
| K20TNRS | BKUR6EK | |
| K20TNRS9 | BKUR6EK-9 | |
| K20TR11 | BKR6EKB-11 | |
| K20TXR | BKR6EKUB | |
| K20U | BKR6EYA | |
| K20U11 | BKR6EYA-11 | |
| K22P11 | BK7EK-N-11 | |
| K22PB | BCP7ET | |
| K22PBR | BKUR7ET | |
| K22PRL11 | BKR7E-N-11 | |
| K22PRTP11 | BKR7EVX-11 | |
| K22PRU | BKR7E | |
| K22PRU11 | BKR7E-11 | |
| K22PRUR | BKR7E | |
| K22PRZU | BKR7EVX | |

| DENSO | → NGK Typ | V-LINE |
|--------------|------------------|---------------|
| K22PRZU11 | BKR7EVX-11 | |
| K22PU11 | BK7E-11 | |
| K22TM11 | BK7EK-N-11 | |
| K22TMR | BKR7EKC-N | |
| K22TMR11 | BKR7EKC-N-11 | |
| K22TNRS | BKUR7EK | |
| K24PRU11 | BKR8E-11 | |
| K29AZ | R7434-10 | |
| KJ14CR11 | ZFR4F-11 | |
| KJ14CRL11 | ZFR4F-11 | |
| KJ16CR | ZFR5F | |
| KJ16CR11 | ZFR5J-11 | |
| KJ16CRL11 | ZFR5F-11 | |
| KJ16CRU11 | ZFR5F-11 | |
| KJ206CRL11 | ZFR6F-11 | |
| KJ20CR11 | ZFR6J-11 | |
| KJ20CRL11 | ZFR6F-11 | |
| KJ20CRU11 | ZFR6F-11 | |
| KJ20DRM11 | ZFR6K-11 | |
| KJ20DRM11S | ZFR6K11S | |
| KJ20SR11 | ZFR6FIX-11 | |
| KJ22CR11 | ZFR7F-11 | |
| KJ22CRL11 | ZFR7F-11 | |
| KJ22CRL8 | ZFR7F | |
| MA14PU | AP5FS | |
| MA16PRU | APR5FS | |
| MA16PRU11 | APR5FS | |
| MA16PRU15 | APR5FS | |
| MA16PU | AP5FS | |
| MA17PU | AP6FS | |
| MA20PRU | APR6FS | |
| MA20PU | AP6FS | |
| MA20RU | AR6FS | |
| MA20RU11 | AR6FS | |
| MA9PU | AP4FS | |
| P16PR11 | PGR5A-11 | |
| P16PR8 | PGR5A | |
| P16R | BPR5EP-11 | |
| P16R13 | BPR5EP-13 | |
| P20PR11 | PGR6A-11 | |
| P20PR8 | PGR6A | |
| P20R8 | BPR6EP-8 | |
| P22PR8 | PGR7A | |
| PK16PR11 | PFR5B-11 | |
| PK16PRL11 | PFR5G-11 | |
| PK16PRP11 | PFR5J-11 | |
| PK16R11 | BKR5EP-11 | |
| PK16TR11 | BKR5EKP-11 | |
| PK16TR13 | BKR5EKP-13 | |
| PK20GR8 | BKR6EPA-8 | |
| PK20PR11 | PFR6B-11 | |
| PK20PRL11 | PFR6G-11 | |



| DENSO | → NGK Typ | V-LINE |
|--------------|------------------|---------------|
| PK20PRL13 | PFR6G-13 | |
| PK20PRP | PFR6J | |
| PK20PRP11 | PFR6J-11 | |
| PK20PRP8 | PFR6J | |
| PK20PRTP | PFR6M | |
| PK20PTRS9 | BKR6EKPA | |
| PK20R11 | BKR6EP-11 | |
| PK20R13 | BKR6EP-13 | |
| PK20R8 | BKR6EP-8 | |
| PK20RP8 | BKR6EP-N-8 | |
| PK20TR11 | BKR6EKPB-11 | |
| PK22PR11 | PFR7B-11 | |
| PK22PR8 | PFR7B | |
| PK22PRL11 | PFR7G-11 | |
| PK22PRL11S | PFR7G-11S | |
| PK22PRTP | PFR7M | |
| PKJ16CR8 | PZFR5F | |
| PKJ16CRL11 | PZFR5F-11 | |
| PKJ16CRL13 | PZFR5F-13 | |
| PKJ20CR8 | PZFR6F | |
| PKJ20CRL11 | PZFR6F-11 | |
| PKJ20CRM11 | PZFR6F-11 | |
| PQ16R | BCPR5EIX-11 | |
| PQ16R13 | BCPR5EIX-11 | |
| PQ16R8 | BCPR5EP-8 | |
| PQ20R | BCPR6EP-11 | |
| PQ20R13 | BCPR6EIX-11 | |
| PQ20R8 | BCPR6EP-8 | |
| PQ20RP11 | BCPR6EIX-11 | |
| PQ20RP8 | BCPR6EP-N-8 | |
| PT16EPRC13 | PTR5C-13 | |
| PT16EPRL13 | PTR5D-10 | V-Line No. 31 |
| PT16VR13 | PTR5A-13 | V-Line No. 25 |
| PTJ16R15 | PZTR5A-15 | |
| Q14RU11 | BCPR4EY-11 | |
| Q16PRTP11 | BCPR5EIX-11 | |
| Q16PRU | BCPR5E | V-Line No. 32 |
| Q16PRU11 | BCPR5EY-11 | |
| Q16PRUL11 | BCPR5EY-N-11 | |
| Q16PRZU11 | BCPR5EIX-11 | |
| Q16PU11 | BCPR5EY-11 | |
| Q16RU | BCPR5EY | |
| Q16RU11 | BCPR5EY-11 | |
| Q16RZU11 | BCPR5EIX-11 | |
| Q16U11 | BCPR5EY-11 | |
| Q16ZU11 | BCPR5EIX-11 | |
| Q20PRP11 | BCPR6EVX-11 | |
| Q20PRU | BKR6E | V-Line No. 28 |
| Q20PRU11 | BCPR6EY-11 | |
| Q20PRUL11 | BCPR6EY-N-11 | |
| Q20PRZU11 | BCPR6EVX-11 | |
| Q20PU | BCP6ES | V-Line No. 17 |

| DENSO | → NGK Typ | V-LINE |
|--------------|------------------|---------------|
| Q20PU11 | BKR6E-11 | V-Line No. 14 |
| Q20RU | BCPR6EY | |
| Q20RU11 | BCPR6EY-11 | |
| Q20RZU11 | BCPR6EVX-11 | |
| Q20U | BCP6E | V-Line No. 17 |
| Q20U11 | BKR6E-11 | V-Line No. 14 |
| Q20ZU11 | BCPR6EVX-11 | |
| Q22PRP11 | BKR7EIX-11 | |
| Q22PRU | BCPR7ES | |
| Q22PRU11 | BCPR7ES-11 | |
| Q22PRUL11 | BCPR7EY-N-11 | |
| Q22PRZU | BCP7EVX | |
| Q22PRZU11 | BKR7EIX-11 | |
| Q22PU | BCP7ES | |
| Q22PU11 | BKR7E-11 | |
| Q27AZ | R7435-9 | |
| QJ16ARU | BCRE527Y | |
| QJ16C11 | ZFR5A-11 | |
| QJ16CR11 | ZFR5A-11 | |
| QJ20C11 | ZF6A-11 | |
| QJ20CR11 | ZFR6A-11 | |
| QJ22CR11 | ZFR7F-11 | |
| QL20PRU | BCPR6ED | |
| QL20TRS | BCPR6EKD | |
| QL22TRS | BCPR7EKD | |
| RU0131 | R0045Q-10 | |
| RU0134 | R0045Q-11 | |
| S22PRA7 | IGR7A | |
| S27 | SD9A | |
| S29 | SD10A | |
| S29A | SD10A | |
| S31A | SD11A | |
| SC20HR11 | ILKAR7B11 | |
| SD29A | SD10A | |
| SK16PRA11 | IFR5E11 | |
| SK16PRE11 | IFR5E11 | |
| SK16PRL11 | IFR5G-11K | |
| SK16RP11 | BKR5EIX-11P | |
| SK16RP8 | IFR5T-8N | |
| SK20BGR11 | HB6AIX-11P | |
| SK20BR11 | HB6BIX-11P | |
| SK20HPRL11 | ILFR6J-11K | |
| SK20PRA11 | IFR6E11 | |
| SK20PRA8 | IFR6B-K | |
| SK20PRL9 | IFR6C | |
| SK20PRL9S | IFR6C-S | |
| SK20R11 | IFR6T11 | |
| SK20R8G | LPG1 | |
| SK22PRM11 | IFR7G-11KS | |
| SK22PRM11S | IFR7G-11KS | |
| SKJ16CRL11 | IZFR5F11 | |
| SKJ16DRM11 | IZFR5K11 | |



| DENSO | → NGK Typ | V-LINE |
|--------------|------------------|---------------|
| SKJ20DRM11 | IZFR6K11 | |
| SKJ20DRM11S | IZFR6K-11S | |
| SKJ20DRM13 | IZFR6K13 | |
| SVK20RZ11 | IFR6J11 | |
| SVK20RZ8 | BKR6EP-8 | |
| SXU22HCR11S | ILZKR7B11GS | |
| SXU22HDR8 | ILKR7B8 | |
| SXU22PR9 | IKR7C | |
| T14PRU | BPR4FS | |
| T14PRU15 | BPR4FS-15 | |
| T16EPRU | BPR5EFS | |
| T16EXU | BP5EFS | |
| T16PRU | BPR5FS | |
| T16PRU11 | BPR5FS-11 | |
| T16PRU15 | BPR5FS-15 | |
| T16PU | BP5FS | |
| T16RU | BR5FS | |
| T16RU15 | BR5FS | |
| T16U15 | YR55IX | |
| T20EPRU | BPR6EFS | V-Line No. 7 |
| T20EPRU15 | BPR6EFS-15 | |
| T20EPU | BP6EFS | V-Line No. 5 |
| T20EPU15 | BPR6EFS-15 | |
| T20EXU | BP6EFS | V-Line No. 5 |
| T20PRU | BPR6FS | |
| T20PRU15 | BPR6FS | |
| T20PU | BP6FS | |
| T22EPU | BP7EFS | |
| VK16 | BKR5EIX-11P | |
| VK20 | IZFR6H11 | |
| VK20T | LPG1 | |
| VK22 | IFR7F-6D | |
| VKA20 | HB6AIX-11P | |
| VKB20 | HB6BIX-11P | |
| VKH16 | ILZFR5B | |
| VKH20 | ILZFR6D11 | |
| VNH24Z | IMR8B9H | |
| VQ16 | BCPR5EIX-11P | |
| VQ20 | BCPR6EIX-11P | |
| VW20T | LPG2 | |
| W14EKRS11 | BUR4EB-11 | |
| W14EPR | BPR4ES | |
| W14EPR11 | BPR4ES-11 | |
| W14EPRU | BPR4ES | |
| W14EXRU | BPR4EY | |
| W14EXRU11 | BPR4EY-11 | |
| W14EXRU13 | BPR4ES-13 | |
| W14EXRZU | BPR4EVX | |
| W14EXU | BP4EY | |
| W14EXU11 | BP4EY-11 | |
| W14EXU13 | BPR4ES-13 | |
| W14EXZU | BPR4EVX | |

| DENSO | → NGK Typ | V-LINE |
|--------------|------------------|---------------|
| W16DTRS | BPR5EKB | |
| W16EKRS11 | BUR5EB-11 | |
| W16EKS11 | BUR5EB-11 | |
| W16EP | BP5ES | V-Line No. 8 |
| W16EP11 | BP5ES-11 | |
| W16EPB | BP5EY | |
| W16EPB10 | BP5ET-10 | |
| W16EPGU | BPR5EIX | |
| W16EPR | BPR5ES | V-Line No. 6 |
| W16EPR11 | BPR5ES-11 | |
| W16EPRS11 | BUR5EA-11 | |
| W16EPRU | BPR5ES | V-Line No. 6 |
| W16EPRU10 | BPR5E-11 | |
| W16EPRU11 | BPR5ES-11 | |
| W16EPU | BP5ES | V-Line No. 8 |
| W16EPU10 | BP5ES-11 | |
| W16EPU11 | BP5EY-11 | |
| W16EPZU | BPR5EIX | |
| W16ESL11 | BR5ES | |
| W16ESRL | BR5ES | |
| W16ESRL11 | BUR5EB-11 | |
| W16ESRU | BR5ES | |
| W16ETL | BPR5EY | V-Line No. 9 |
| W16ETRS | BPR5EIX-11 | |
| W16ETS | BP5EK-A | |
| W16EX | BP5EY | |
| W16EXRU | BPR5EY | V-Line No. 9 |
| W16EXRU11 | BPR5EY-11 | |
| W16EXRU13 | BPR5ES-13 | |
| W16EXRZU | BPR5EIX | |
| W16EXU | BP5EY | |
| W16EXU11 | BP5EY-11 | |
| W16EXU13 | BP5ES-13 | |
| W16EXZU | BPR5EIX | |
| W16FP | BP5HS | |
| W16FPR | BPR5HS | |
| W16FPRU | BPR5HS | |
| W16FPU | BP5HS | |
| W16FS | B5HS | |
| W16FSU | B5HS | |
| W17ES | BR6ES | |
| W17FP | BP6HS | V-Line No. 18 |
| W20DTRSA | BPR6EKB-L | |
| W20EA | B6EM | |
| W20EAR | BR6EM | |
| W20EKRS11 | BUR6EB-11 | |
| W20EKS11 | BUR6EB-11 | |
| W20EP11 | BP6ES-11 | |
| W20EPB | BP6ET | V-Line No. 1 |
| W20EPBRS | BUR6ET | V-Line No. 1 |
| W20EPGU | BP6EVX | |
| W20EPR | BPR6ES | V-Line No. 2 |



| DENSO | → NGK Typ | V-LINE |
|--------------|------------------|---------------|
| W20EPR11 | BPR6ES-11 | V-Line No. 13 |
| W20EPRS11 | BUR6EA-11 | |
| W20EPRU | BPR6ES | V-Line No. 2 |
| W20EPRU10 | BPR6ES-11 | V-Line No. 13 |
| W20EPRU11 | BPR6ES-11 | V-Line No. 13 |
| W20EPRZU | BPR6EVX | |
| W20EPRZU11 | BPR6EVX-11 | |
| W20EPS11 | BUR6EA-11 | |
| W20EPU | BP6ES | V-Line No. 4 |
| W20EPU10 | BP6ES-11 | |
| W20EPU11 | BP6ES-11 | |
| W20EPZU | BP6EVX | |
| W20ESGU | B6EVX | |
| W20ESL | BR6ES | |
| W20ESL11 | BUR6EB-11 | |
| W20ESR | BR6ES | |
| W20ESRL | BR6ES | |
| W20ESRL11 | BUR6EB-11 | |
| W20ESRU | BR6ES | |
| W20ESU11 | B6ES-11 | |
| W20ESZU | B6EVX | |
| W20ET | BP6EK | |
| W20ETL | BPR6EKN | |
| W20ETR | BPR6EK-A | |
| W20ETRL | BPR6EKN | |
| W20ETRL8 | BPR6EKN | |
| W20ETRS | BPR6EK-A | |
| W20ETS | BPR6EK-A | |
| W20EXRU | BPR6EY | |
| W20EXRU11 | BPR6EY-11 | V-Line No. 10 |
| W20EXRU13 | BPR6EVX-11 | |
| W20EXRZU | BPR6EVX | |
| W20EXU | BP6EY | |
| W20EXU11 | BP6EY-11 | |
| W20EXU13 | BP6ES-13 | |
| W20EXZU | BP6EVX | |
| W20FP | BP6HS | V-Line No. 18 |
| W20FPR | BPR6HS | V-Line No. 3 |
| W20FPRU | BPR6HS | V-Line No. 3 |
| W20FPU | BP6HS | V-Line No. 18 |
| W21ESL11 | BR6EB-L-11 | |
| W21ESRL11 | BR6EB-L-11 | |
| W22EA | B7EM | |
| W22EAR | BR7EM | |
| W22EB | BR7ET | |
| W22EBR | BR7ET | |
| W22EDR | BR7EQ | |
| W22EDR14 | BR7EQ-14 | |
| W22EKRS11 | BUR7EB-11 | |
| W22EKS11 | BUR7EB-11 | |
| W22EP | BP7ES | |
| W22EP11 | BP7ES-11 | |

| DENSO | → NGK Typ | V-LINE |
|--------------|------------------|---------------|
| W22EPB | BP7ET | |
| W22EPR | BPR7ES | V-Line No. 19 |
| W22EPR11 | BPR7ES-11 | |
| W22EPRS11 | BUR7EA-11 | |
| W22EPRU | BPR7ES | V-Line No. 19 |
| W22EPRU11 | BPR7ES-11 | |
| W22EPRZU | BPR7EIX | |
| W22EPS11 | BUR7EA-11 | |
| W22EPU | BP7ES | |
| W22EPU11 | BP7ES-11 | |
| W22ESL11 | BUR7EB-11 | |
| W22ESRL11 | BUR7EB-11 | |
| W22ESU11 | B7ES-11 | |
| W22ETL | BPR7EKN | |
| W22ETRL | BPR7EKN | |
| W22ETRL8 | BPR7EKN | |
| W22EXRU | BPR7EIX | |
| W22EXRU11 | BPR7EY-11 | |
| W22EXU | BP7EY | |
| W22FP | BP7HS | |
| W22FPU | BP7HS | |
| W22FPUS | BP7HS | |
| W24EP | BP8ES | |
| W24EP11 | BP8ES | |
| W24EPU | BP8ES | |
| W24ESZU | B8EGV | |
| W25EA | BR8EM | |
| W25EAR | BR8EM | |
| W25EB | BR8ET | |
| W25EBR | BR8ET | |
| W25EDR | BR8EQ | |
| W25EDR14 | BR8EQ-14 | |
| W25EPT | B8EGP | |
| W27EBR | BR9ET | |
| W27EDR | BR9EQ-14 | |
| W27EDR14 | BR9EQ-14 | |
| W27ESC | B9ECS | |
| W27ESZU | B9EGV | |
| W27FSR | BR9HS | |
| W27S | B9S | |
| W27SU | B9S | |
| W29EBR | BR10ET | |
| W29EPT | B95EGP | |
| W29ESGU | B95EGV | |
| W29ESZU | B95EGV | |
| W31EPT | B10EGP | |
| W31ESZU | B10EGV | |
| W32EPT | B105EGP | |
| W34ESZU | B11EGV | |
| X22EPRGL | PJR7A | |
| X22GPRU | DPR7Z | |
| X22GPU | DPR7Z | |



| DENSO | → NGK Typ | V-LINE |
|--------------|------------------|---------------|
| XE20HRU9 | LZKAR7A | |
| XU20EPRU | DCPR6E | |
| XU22EPP | DCP7EVX | |
| XU22EPR | DCPR7E | |
| XU22EPRP | DCPR7EVX | |
| XU22EPRU | DCPR7E | |
| XU22EPRZU | DCPR7EVX | |
| XU22EPU | DCP7E | |
| XU22EPZU | DCP7EVX | |
| XU22HDR9 | LKR7B-9 | |
| XU22HR9 | LKR7C | |
| XU24EPRP | DCPR8EVX | |
| XU24EPRU | DCPR8E | |
| XU24EPRZU | DCPR8EVX | |
| XU24EPU | DCP8E | |
| XU24EPZU | DCPR8EVX | |
| XU27EPRU | DCPR9E | |
| XU27EPRZU | DCPR9EVX | |
| ZXU20PR11 | IKR6G11 | |

DODGE => siehe CHRYSLER

| EYQUEM | → NGK Typ | V-LINE |
|---------------|------------------|---------------|
| 400J | BR5FS | |
| 406 | BP6HS | V-Line No. 18 |
| 450JS | BPR4FS-15 | |
| 500JS | BPR4FS | |
| 500M | B5HS | |
| 505JS | BP5FS | |
| 50M | B5HS | |
| 550JS | BPR5FS | |
| 550LS | BP5ES | V-Line No. 8 |
| 580LS | BP5ES | V-Line No. 8 |
| 600JS | BPR6FS | |
| 600LS | BP6ES | V-Line No. 4 |
| 600S | BP5HS | |
| 705JS | BP7FS | |
| 705S | BP6HS | V-Line No. 18 |
| 707LS | BP6ES | V-Line No. 4 |
| 750 | BP6HS | V-Line No. 18 |
| 750LJS | BP6EFS | V-Line No. 5 |
| 750LS | BP6ES | V-Line No. 4 |
| 753LJS | BP6EFS | V-Line No. 5 |
| 755LJS | BP6EFS | V-Line No. 5 |
| 755LS | BP6ES | V-Line No. 4 |
| 755S | BP6HS | V-Line No. 18 |
| 775SX | BP6HS | V-Line No. 18 |
| 800LJS | BP6EFS | V-Line No. 5 |
| 800LS | BP6ES | V-Line No. 4 |
| 803LJS | BP6EFS | V-Line No. 5 |
| 805LJS | BP7EFS | |
| 805LJSP | BP7EFVX | |

| EYQUEM | → NGK Typ | V-LINE |
|---------------|------------------|---------------|
| 850LS | BP7ES | |
| 883LJP | B8EFS | |
| C32 | B5HS | |
| C32LS | BP5ES | V-Line No. 8 |
| C32S | BP5HS | |
| C42LJS3 | BP6EFS | V-Line No. 5 |
| C42S | BP6HS | V-Line No. 18 |
| C52LS | BP5ES | V-Line No. 8 |
| C62LJS | BP6EFS | V-Line No. 5 |
| C62LS | BP6ES | V-Line No. 4 |
| C62LS3X | BP5ET | |
| C62S | BP7HS | |
| C72LJS | BP7EFS | |
| C72LS | BP7ES | |
| C72LS3X | BP6ET | V-Line No. 1 |
| C82LJS | BP7EFS | |
| C82LS | BP7ES | |
| C82LS3X | BP7ET | |
| C92LS | BP8ES | |
| FC42LS | BCP5ES | V-Line No. 16 |
| FC52LS | BCP5ES | V-Line No. 16 |
| FC58LS | BCP6ES | V-Line No. 17 |
| FC62LS | BCP6ES | V-Line No. 17 |
| FC62LS2 | BCP6ES | V-Line No. 17 |
| FC62LS3 | BCP6ET | |
| FC62LS3X | BCP6ET | |
| FC72LS | BCP7ES | |
| FC82LS | BCPR7E | |
| FC82LS1 | BCP7ES | |
| FC82LS2 | BCP7ES | |
| FN52LS | BK5ESZ | |
| K300JS | AP5FS | |
| K350JS | AP5FS | |
| K450JS | AP5FS | |
| K550JS | AP6FS | |
| KC62JS | AP6FS | |
| RC32LS5 | BPR4ES-11 | |
| RC42S | BPR6HS | V-Line No. 3 |
| RC52LS | BPR5EY | V-Line No. 9 |
| RC52LS5 | BPR5EY-11 | |
| RC52LZ3EX | BUR5ET | V-Line No. 22 |
| RC52LZE | ZGR5A | V-Line No. 15 |
| RC58LZ3EX | BUR6ET | V-Line No. 1 |
| RC62HJSDP | PTR5A-13 | V-Line No. 25 |
| RC62LJS | BPR6EFS | V-Line No. 7 |
| RC62LS | BPR6ES | V-Line No. 2 |
| RC62LS5 | BPR6ES-11 | V-Line No. 13 |
| RC82LS | BPR7ES | V-Line No. 19 |
| RC82LS5 | BPR7EY-11 | |
| RFC42LS | BKR5ES | V-Line No. 35 |
| RFC42LS2E | BKR5EK | V-Line No. 23 |
| RFC42LZ2E | BKR6EK | V-Line No. 20 |



| EYQUEM | → NGK Typ | V-LINE |
|---------------|------------------|---------------|
| RFC50LZ2E | BKR5EK | V-Line No. 23 |
| RFC52LS | BKR5ES | V-Line No. 35 |
| RFC52LS3 | BCPR5ET | |
| RFC52LS5 | BKR5ES-11 | V-Line No. 33 |
| RFC52LSP | BKR6EK | V-Line No. 20 |
| RFC52LZ3EX | BKUR5ET | V-Line No. 29 |
| RFC52LZE | ZFR5F | |
| RFC52LZK | BKR5EZ | V-Line No. 36 |
| RFC57LS3 | BCPR6ET | |
| RFC58LS | BKR6ES | V-Line No. 28 |
| RFC58LS2E | BKR6EK | V-Line No. 20 |
| RFC58LS3 | BCPR6ET | |
| RFC58LS5 | BKR6ES-11 | V-Line No. 14 |
| RFC58LSP | BKR6EZ | V-Line No. 38 |
| RFC58LZ | BKR6EY | |
| RFC58LZ2 | BKR6EKC | V-Line No. 26 |
| RFC58LZ2E | BKR5EZ | V-Line No. 36 |
| RFC58LZ3EX | BKUR6ET | V-Line No. 27 |
| RFC58LZ5 | BKR6EY-11 | |
| RFC58LZDP | PFR6G-9 | |
| RFC58LZE5 | ZFR6F-11 | |
| RFC62LS3 | BKR6ES-11 | V-Line No. 14 |
| RFC62LS3X | BCPR6ET | |
| RFC62LS5 | BKR6ES-11 | V-Line No. 14 |
| RFC62LZ3X | BKUR7ET | |
| RFC82LS | BCPR7ES | |
| RFC82LS5 | BCPR7ES-11 | |
| RFCLZ3X | BKUR7ET | |
| RFN52HZ | LFR5B | |
| RFN58HZ | LFR6B | |
| RFN58LZ | BKR6EK | V-Line No. 20 |
| XKC62JS | APR6FS | |

FERRARI => siehe FIAT Group

| FIAT Group | → NGK Typ | V-LINE |
|-------------------|------------------|---------------|
| 155743 | PKR9B | |
| 168325 | PMR8A | |
| 169483 | PMR7A | |
| 192637 | PMR8B | |
| 313253225 | DCPR8E | |
| 46144731 | DCPR8E | |
| 46229251 | BP6ES | V-Line No. 4 |
| 464133860 | BKR6EKC | V-Line No. 26 |
| 46417010 | BKR6E | V-Line No. 28 |
| 46449690 | BKR6EKPA | |
| 46463801 | BKR6EKC | V-Line No. 26 |
| 46471078 | BKUR6ETB | |
| 46472021 | BKR6EKC | V-Line No. 26 |
| 46475164 | BCPR7ET | |
| 46480307 | BKR6EKC | V-Line No. 26 |
| 464803070 | BKR6EKC | V-Line No. 26 |

| FIAT Group | → NGK Typ | V-LINE |
|-------------------|------------------|---------------|
| 46480309 | BKR5EKC | |
| 464803090 | BKR5EKC | |
| 46480362 | BKR6E | V-Line No. 28 |
| 464803620 | BKR6E | V-Line No. 28 |
| 46481273 | DCPR8E | |
| 464812730 | DCPR8E | |
| 46484273 | DCPR8E | |
| 46521529 | BKR6EKPA | |
| 46521530 | PMR7A | |
| 465215300 | PMR7A | |
| 46531917 | DCPR8EKC | |
| 465319170 | DCPR8EKC | |
| 46531918 | BKR5EZ | V-Line No. 36 |
| 465319180 | BKR5EZ | V-Line No. 36 |
| 46548478 | BKR6EZ | V-Line No. 38 |
| 465484780 | BKR6EZ | V-Line No. 38 |
| 46549576 | BKR6EKPA | |
| 465495760 | BKR6EKPA | |
| 46549577 | PMR7A | |
| 465495770 | PMR7A | |
| 46550991 | BKUR6ETB | |
| 465509910 | BKUR6ETB | |
| 46550992 | CR7EKC | |
| 465509920 | CR7EKC | |
| 46750545 | DCPR8E-N | |
| 467505450 | DCPR8E-N | |
| 46759688 | BP6E | V-Line No. 4 |
| 467596880 | BP6E | V-Line No. 4 |
| 46823299 | DCPR7E-N | |
| 468232990 | DCPR7E-N | |
| 55182623 | FR5CP | |
| 55188857 | DCPR7E-N-10 | |
| 551888570 | DCPR7E-N-10 | |
| 55190788 | ZKR7A-10 | |
| 551907880 | ZKR7A-10 | |
| 55210685 | IKR9F8 | |
| 552106850 | IKR9F8 | |
| 5894585 | BPR7ES | V-Line No. 19 |
| 5894586 | BKR6E | V-Line No. 28 |
| 5894588 | BCPR7ES | |
| 5896824 | BKR6EKC | V-Line No. 26 |
| 5984036 | BPR6ES | V-Line No. 2 |
| 603302211 | BP7HS | |
| 60504563 | BP6ES | V-Line No. 4 |
| 60512848 | BCP6ET | |
| 60569086 | PGR6A | |
| 60569957 | PFR6B | |
| 60579903 | PFR6B | |
| 60597490 | BCP7ES | |
| 60599495 | PMR7A | |
| 60800325 | BPR7ES | V-Line No. 19 |
| 60806024 | BP6ET | V-Line No. 1 |



| FIAT Group | → NGK Typ | V-LINE |
|-------------------|------------------|---------------|
| 60810689 | PFR6B | |
| 71711638 | BKR6E | V-Line No. 28 |
| 71711639 | BPR6ES | V-Line No. 2 |
| 71711640 | BPR6ES | V-Line No. 2 |
| 71711806 | BPR6ES | V-Line No. 2 |
| 71711808 | BKR6E | V-Line No. 28 |
| 7546519 | BKR6E | V-Line No. 28 |
| 7554436 | BPR7ES | V-Line No. 19 |
| 7554442 | BP6ES | V-Line No. 4 |
| 7554444 | BPR6ES | V-Line No. 2 |
| 7554445 | BP6HS | V-Line No. 18 |
| 7686643 | BP6ET | V-Line No. 1 |
| 7760381 | BPR7ES | V-Line No. 19 |
| 7760382 | BPR6ES | V-Line No. 2 |
| 7760383 | BKR6E | V-Line No. 28 |
| 7760384 | BCPR7ES | |
| 7769243 | BCPR6ET | |
| 7772453 | BKR6E | V-Line No. 28 |
| 7772515 | BPR7ES | V-Line No. 19 |
| 7910247204 | BPR6EFS | V-Line No. 7 |
| 7FYSR | BPR7ES | V-Line No. 19 |
| 7FYSSR | BPR7ES | V-Line No. 19 |
| 7GBYSR4 | BCPR7ET | |
| 7GYSSR | BCPR7ES | |
| 9614738680 | BKR6EK | V-Line No. 20 |
| 9618494580 | BKR5EK | V-Line No. 23 |
| 9618571880 | BKR6EK | V-Line No. 20 |
| 9619624580 | BKR5EK | V-Line No. 23 |
| 9FYSSR | BPR6ES | V-Line No. 2 |
| 9GYSSR | BKR6E | V-Line No. 28 |
| FORD | → NGK Typ | V-LINE |
| 10 32 705 | BKR5EKUP | |
| 10 77 002 | PTR5A-13 | V-Line No. 25 |
| 11 20 170 | PZFR5D-11 | V-Line No. 34 |
| 12 02 935 | PLTR6A-10G | |
| 12 04 572 | PTR6F-13 | |
| 12 19 309 | TR5B-13 | |
| 12 55 464 | TR5B-13 | |
| 13 07 093 | PTR6D-13G | |
| 13 15 691 | ITR6F13 | |
| 13 69 704 | TR6AP-13 | |
| 13 79 739 | ILTR5A-13G | |
| 15 42 499 | ZKR7A-10 | |
| 1M50-12405-CA | PLTR6A-10G | |
| 1S7J-12405-DA | PTR6F-13 | |
| 1S7J-12405-EB | PTR6D-13G | |
| 3S4J-12405-AB | ITR6F13 | |
| 43 31 810 | PTR5D-13 | |
| 48 92 591 | PZNAR6A11H | |
| 5M5G 12405 AA | TR6AP-13 | |
| 6118-61240-5BB | ILTR5A-13G | |

| FORD | → NGK Typ | V-LINE |
|--------------------|------------------|---------------|
| 6M8G-12405-BB | ILTR5A-13G | |
| 8L3E-12405-BB | PZNAR6A11H | |
| 95VW-12405-DA | BKR5EKUP | |
| 9S51-12405-AA | ZKR7A-10 | |
| F43E-12405-EB | PTR5D-13 | |
| XS4F-12405-DA | PTR5A-13 | V-Line No. 25 |
| YM21-12405-AA | PZFR5D-11 | V-Line No. 34 |
| YN2F-12405-A2A | TR5B-13 | |
| YN2J-12405-AA | TR5B-13 | |
| GM | → NGK Typ | V-LINE |
| 12 556 183 | PTR5C-13 | |
| 12 561 466 | PTR5C-13 | |
| 12 563 707 | PZTR5A-15 | |
| 12 565 030 | PTR4B-15 | |
| 12 565 996 | LTR6AP-11 | |
| 12 568 387 | ITR4A15 | |
| 12 571 535 | PTR5C-13 | |
| 12 578 277 | PZTR5A-15 | |
| 12 591 131 | IZTR4A11 | |
| 12 598 004 | ILTR5B11 | |
| 12 607 234 | PTR4G-15 | |
| 12 607 280 | ILTR5C11 | |
| 12 611 882 | ILTR6B11 | |
| 12 787 099 | PFR6T-10G | |
| 12 788 884 | PLFR6C-10G | |
| 24 504 873 | PTR4B-15 | |
| 55 564 215 | BKR7ESC-11 | |
| 92 141 875 | BPR6EFS-15 | |
| HONDA | → NGK Typ | V-LINE |
| 12260-RL6-G010 | ILZKR7B11GS | |
| 12290-P5M-A000 | PZFR6F-11 | |
| 12290-P73-J001 | PFR7G-11 | |
| 12290-PCX-0000 | PFR7G-11S | |
| 12290-PCX-9999-TA | PFR7G-11S | |
| 12290-PCX-J000 | PFR7G-11S | |
| 12290-PFD-J000 | IFR6C | |
| 12290-PGE-A01 | PZFR6F-11 | |
| 12290-PLE-0030 | IZFR5F11 | |
| 12290-PNA-0030 | IZFR6K13 | |
| 12290-PND-A010-M1 | IZFR6K11 | |
| 12290-PNE-0030 | ZFR6K-11 | |
| 12290-PRB-A01 | IFR7G-11KS | |
| 12290-PRB-A010-M1 | IFR7G-11KS | |
| 12290-R40-A01 | ILZKR7B-11S | |
| 12290-R40-A010-M1 | ILZKR7B-11S | |
| 12290-R40-AA012-M1 | ILZKR7B-11S | |
| 12290-R60-U01 | IZFR6K11NS | |
| 12290-R60-U010-M1 | IZFR6K11NS | |
| 12290-RB1-003 | IZFR6K13 | |
| 12290-RB1-0030 | IZFR6K13 | |



| HONDA | → NGK Typ | V-LINE |
|-------------------|------------------|---------------|
| 12290-RB1-0031 | IZFR6K13 | |
| 12290-RGB-0130 | IFR6C-S | |
| 12290-RGB-A0040 | IFR6C-S | |
| 12290-RL6-G01 | ILZKR7B11GS | |
| 12290-RL6-G010-M1 | ILZKR7B11GS | |
| 12290-RMX-003 | ILFR6J-11K | |
| 12290-RMX-0030 | ILFR6J-11K | |
| 12290-RMX-013 | ILFR6J-11K | |
| 12290-RMX-0130 | ILFR6J-11K | |
| 12290-RSH-003 | IFR6G-11K | |
| 12290-RSH-0030 | IFR6G-11K | |
| 12290-RWC-A01 | SILKR8A-S | |
| 12290-RWC-A011-M1 | SILKR8A-S | |
| 31901-NN2-0030 | BR6ES | |
| 31910-MEE-R110-M1 | R0409B-10 | |
| 31911-KRN-731 | R0409B-8 | |
| 31911-KRN-7310-M1 | R0409B-8 | |
| 31911-MCW-003 | IMR8B9H | |
| 31911-MCW-0030 | IMR8B9H | |
| 31912-KRN-731 | R0409B-9 | |
| 31912-MEE-671 | IMR9C9HE | |
| 31912-MEE-6710-M1 | IMR9C9HE | |
| 31914-ZOH-003 | CMR4H | |
| 31914-ZOH-0030 | CMR4H | |
| 31914-ZOH-0031 | CMR4H | |
| 31914-ZOH-003 | CMR4H | |
| 3191W-ZOM-5400 | BPR4ES | |
| 3191W-ZOM-5500 | BPR5ES | V-Line No. 6 |
| 3191W-ZOM-5600 | BPR6ES | V-Line No. 2 |
| 31921-MOW-004 | IMR8B9H | |
| 31940-NX5-7520-M1 | R7282-105 | |
| 31940-NX5-9410 | R7282-105 | |
| 31999-KW6-6500 | B9ECS | |
| 89819-99010 | BPR5ES | V-Line No. 6 |
| 89839-99010 | BPR6ES | V-Line No. 2 |
| 98056-54717 | C4HA | |
| 98056-55717 | C5HA | |
| 98056-57717 | C7HA | |
| 98056-57918 | CR7HSA9 | |
| 98061-57616 | DPR7Z | |
| 98069-56718 | DR6EA | |
| 98069-5691U | IJR6A9 | |
| 98069-5697Q | DCPR6E | |
| 98069-5797Q | DCPR7E | |
| 98069-63410 | D13E | |
| 98076-52716 | BPR2HS | |
| 98076-52717 | BPR2HS | |
| 98076-54713 | BP4HSA | |
| 98076-55711 | BP5HS | |
| 98076-55717 | BPR5HS | |
| 98076-55719 | BP5HS | |
| 98076-55747 | BPR5HS | |

| HONDA | → NGK Typ | V-LINE |
|----------------|------------------|---------------|
| 98076-56717 | BPR6HS | |
| 98076-56719 | BP6HS | V-Line No. 18 |
| 98076-56719-02 | BP6HS | V-Line No. 18 |
| 98076-56721 | BP6HS | V-Line No. 18 |
| 98076-56729 | BPR6HS | |
| 98076-56747 | BPR6HS | |
| 98076-56756 | BPR6HS | |
| 98076-57711 | BP7HS | |
| 98076-57719 | BP7HS | |
| 98076-57719-01 | BP7HS | |
| 98076-59716 | BR9HS | |
| 98079-54148 | BCPR4ES-11 | |
| 98079-5414G | ZFR4F-11 | |
| 98079-54173 | BUR4EB-11 | |
| 98079-54817 | BPR4ES | |
| 98079-54846 | BPR4ES | |
| 98079-55132 | BPR5EY-11 | |
| 98079-55140 | BCPR5EY-11 | |
| 98079-55141 | BP5EY-11 | |
| 98079-55144 | BP5ES-11 | |
| 98079-55145 | BPR5ES-11 | |
| 98079-55146 | BPR5EY-11 | |
| 98079-55147 | BCPR5ES-11 | |
| 98079-55148 | BCPR5E-11 | |
| 98079-55149 | BCPR5EY-11 | |
| 98079-5514A | BCPR5EY-N-11 | |
| 98079-5514B | BCPR5E-11 | |
| 98079-5514E | BKR5E-11 | V-Line No. 33 |
| 98079-5514E-H0 | BKR5E-11 | V-Line No. 33 |
| 98079-5514F | BCPR5EIX-11 | |
| 98079-5514G | ZFR5F-11 | |
| 98079-5514G-01 | ZFR5F-11 | |
| 98079-5514H | PFR5G-11 | |
| 98079-5514J | BKR5E-N-11 | |
| 98079-5514N | PZFR5F-11 | |
| 98079-5514N-01 | PZFR5F-11 | |
| 98079-5514P | ZFR5J-11 | |
| 98079-5514P-H0 | ZFR5J-11 | |
| 98079-55155 | BPR5E-11 | |
| 98079-55158 | BCPR5E-11 | |
| 98079-5515E | BKR5E-11 | V-Line No. 33 |
| 98079-5515G | ZFR6F-11 | |
| 98079-5515H | PFR5G-11 | |
| 98079-5515J | BKR5E-N-11 | |
| 98079-5515N | PZFR5F-11 | |
| 98079-5515W | IZFR5F11 | |
| 98079-55173 | BUR5EB-11 | |
| 98079-55174 | BUR5EB-11 | |
| 98079-55176 | BUR5EB-11 | |
| 98079-55178 | BUR5EB-11 | |
| 98079-5517S | PFR5L-11 | |
| 98079-5517V | IFR5G-11K | |



| HONDA | → NGK Typ | V-LINE |
|----------------|------------------|---------------|
| 98079-5517W | IZFR5F11 | |
| 98079-55183 | BUR5EB-11 | |
| 98079-55811 | BP5ES | V-Line No. 8 |
| 98079-55816 | BR5ES | |
| 98079-55817 | BPR5ES | V-Line No. 6 |
| 98079-55841 | BP5ES | V-Line No. 8 |
| 98079-55841-03 | BP5ES | V-Line No. 8 |
| 98079-55844 | BPR5EIX | |
| 98079-55846 | BPR5ES | V-Line No. 6 |
| 98079-55847 | BR5ES | |
| 98079-55848 | BR5ES | |
| 98079-55849 | BR5ES | |
| 98079-55855 | BPR5E | V-Line No. 6 |
| 98079-5585C | BKR5E | V-Line No. 35 |
| 98079-5585V | ZGR5A | V-Line No. 15 |
| 98079-55876 | BPR5ES | V-Line No. 6 |
| 98079-55876-HO | BPR5ES | V-Line No. 6 |
| 98079-5587G | ZFR5F | |
| 98079-5587V | ZGR5A | V-Line No. 15 |
| 98079-55941 | BP5EY | |
| 98079-55946 | BPR5EY | V-Line No. 9 |
| 98079-55A4N | PZFR5F-13 | |
| 98079-55A5N | PZFR5F-13 | |
| 98079-56115 | BPR6ES-11 | V-Line No. 13 |
| 98079-5611R-00 | ZFR6F-11 | |
| 98079-56132 | BPR6EY-11 | V-Line No. 10 |
| 98079-56144 | BP6ES-11 | |
| 98079-56145 | BPR6ES-11 | V-Line No. 13 |
| 98079-56146 | BPR6EY-11 | V-Line No. 10 |
| 98079-56147 | BCPR6ES-11 | V-Line No. 11 |
| 98079-56148 | BCPR6E-11 | V-Line No. 11 |
| 98079-56149 | BCPR6EY-11 | |
| 98079-5614A | BCPR6EY-N-11 | |
| 98079-5614B | BKR6E-11 | V-Line No. 14 |
| 98079-5614E | BKR6E-11 | V-Line No. 14 |
| 98079-5614F | BCPR6EVX-11 | |
| 98079-5614G | ZFR6F-11 | |
| 98079-5614G-01 | ZFR6F-11 | |
| 98079-5614H | PFR6G-11 | |
| 98079-5614J | BKR6E-N-11 | |
| 98079-5614J-01 | BKR6E-N-11 | |
| 98079-5614N | PZFR6F-11 | |
| 98079-5614P | ZFR6J-11 | |
| 98079-5614P-00 | ZFR6J-11 | |
| 98079-56155 | BPR6ES-11 | V-Line No. 13 |
| 98079-56158 | BCPR6EY-11 | |
| 98079-5615E | BKR6E-11 | V-Line No. 14 |
| 98079-5615F | BCPR6EVX-11 | |
| 98079-5615G | ZFR6F-11 | |
| 98079-5615H | PFR6G-11 | |
| 98079-5615J | BKR6E-N-11 | |
| 98079-5615N | PZFR6F-11 | |

| HONDA | → NGK Typ | V-LINE |
|----------------|------------------|---------------|
| 98079-56173 | BUR6EB-11 | |
| 98079-56174 | BUR6EB-11 | |
| 98079-56175 | BP6EY-11 | |
| 98079-56179 | BUR6EB-11 | |
| 98079-5617S | PFR6L-11 | |
| 98079-5617T | PFR6N-11 | |
| 98079-5617V | IFR6G-11K | |
| 98079-56183 | BUR6EB-11 | |
| 98079-56614 | B6EVX | |
| 98079-56811 | BP6ES | V-Line No. 4 |
| 98079-56817 | BR6ES | |
| 98079-56832 | BPR6EY | |
| 98079-56841 | BP6ES | V-Line No. 4 |
| 98079-56844 | BP6EVX | |
| 98079-56846 | BPR6ES | V-Line No. 2 |
| 98079-56847 | BR6ES | |
| 98079-56849 | BR6ES | |
| 98079-56854 | BP6ES | V-Line No. 4 |
| 98079-56855 | BPR6ES | V-Line No. 2 |
| 98079-5685C | BKR6E | V-Line No. 28 |
| 98079-56871-HO | BP6ES | V-Line No. 4 |
| 98079-56874 | B6EVX | |
| 98079-56876-HO | BPR6ES | V-Line No. 2 |
| 98079-56941 | BP6EY | |
| 98079-56946 | BPR6EY | |
| 98079-5695U | IFR6C | |
| 98079-5697U | IFR6C | |
| 98079-569BE | BKR6E-9S | |
| 98079-569BU | IFR6C-S | |
| 98079-569CE | BKR6E-9S | |
| 98079-569CU | IFR6C-S | |
| 98079-56A7H | PFR6G-13 | |
| 98079-56A7S | PFR6L-13 | |
| 98079-57144 | BP7ES-11 | |
| 98079-57145 | BPR7ES-11 | |
| 98079-57146 | BPR7EY-11 | |
| 98079-57147 | BCPR7ES-11 | |
| 98079-57148 | BCPR7E-11 | |
| 98079-57149 | BCPR7EY-11 | |
| 98079-5714A | BCPR7EY-N-11 | |
| 98079-5714B | BCPR7E-11 | |
| 98079-5714E | BKR7E-11 | |
| 98079-5714F | BKR7EIX-11 | |
| 98079-5714G | ZFR7F-11 | |
| 98079-5714H | PFR7G-11 | |
| 98079-5714J | BKR7E-N-11 | |
| 98079-5714P | ZFR7J-11 | |
| 98079-57155-01 | BPR7ES-11 | |
| 98079-57158 | BCPR7E-11 | |
| 98079-5715E | BKR7E-11 | |
| 98079-5715F | BKR7EIX-11 | |
| 98079-5715G | ZFR7F-11 | |



| HONDA | → NGK Typ | V-LINE |
|----------------|------------------|---------------|
| 98079-5715H | PFR7G-11 | |
| 98079-5715J | BKR7E-N-11 | |
| 98079-5715V | IFR7G-11KS | |
| 98079-57171 | BPR7EY-11 | |
| 98079-57173 | BUR7EB-11 | |
| 98079-57174 | BUR7EB-11 | |
| 98079-57175 | BR6EB-L-11 | |
| 98079-57176 | BR6ES | |
| 98079-57177 | BUR7EB-11 | |
| 98079-57178 | BUR7EB-11 | |
| 98079-57179 | BPR7EY-11 | |
| 98079-5717U | IFR7L11 | |
| 98079-5717V | IFR7G-11KS | |
| 98079-57183 | BUR7EB-11 | |
| 98079-571BH | PFR7G-11S | |
| 98079-571BV | IFR7G-11KS | |
| 98079-571CH | PFR7G-11S | |
| 98079-571CV | IFR7G-11KS | |
| 98079-57811 | BP7ES | |
| 98079-57811-01 | BP7ES | |
| 98079-57841 | BP7ES | |
| 98079-57846 | BPR7ES | V-Line No. 19 |
| 98079-57855 | BPR7ES | V-Line No. 19 |
| 98079-5785C | BKR7E | |
| 98079-5785G | ZFR7F | |
| 98079-5787G | ZFR7F | |
| 98079-5787T | PFR7N-D | |
| 98079-57941 | BP7EY | |
| 98079-57946 | BPR7EIX | |
| 98079-5814E | BKR8E-11 | |
| 98079-5815E | BKR8E-11 | |
| 98079-58812 | B9ECS | |
| 98079-58841 | BP8ES | |
| 98079-58842 | B8ECS | |
| 98079-58872 | B8ECS | |
| 98079-59812 | B9ECS | |
| 98079-59842 | B9ECS | |
| 98079-59872 | B9ECS | |
| 98079-60842 | B10ECS | |
| 98079-60872 | B10ECS | |
| 9807B-5515W | IZFR5K11 | |
| 9807B-5517W | IZFR5K11 | |
| 9807B-5615P | ZFR6K-11 | |
| 9807B-5615W | IZFR6K11 | |
| 9807B-5617P | ZFR6K-11 | |
| 9807B-5617P-00 | ZFR6K-11 | |
| 9807B-5617W | IZFR6K11 | |
| 9807B-561BP | ZFR6K11S | |
| 9807B-561BP-H0 | ZFR6K11S | |
| 9807B-561BW | IZFR6K-11S | |
| 9807B-561CP | ZFR6K11S | |
| 9807B-56A5W | IZFR6K13 | |

| HONDA | → NGK Typ | V-LINE |
|-----------------|------------------|---------------|
| 9807B-56A7W | IZFR6K13 | |
| 98179-56841 | BP6ES | V-Line No. 4 |
| HYUNDAI | → NGK Typ | V-LINE |
| 09482-00538 | IFR5G11 | |
| 18811-08061 | BPR6ES | V-Line No. 2 |
| 18811-11051 | BPR5ES-11 | |
| 18814-08061 | BKR6ES | V-Line No. 28 |
| 18814-08062 | BKR6ES | V-Line No. 28 |
| 18814-11051 | BKR5E-11 | V-Line No. 33 |
| 18814-25000 | IFR5E11 | |
| 18817-11051 | PFR5N-11 | |
| 18822-08091 | BP6ES-11 | |
| 18827-09080 | PLKR7A | |
| 18829-11050 | BKR5ES-11 | V-Line No. 33 |
| 18840-11051 | ILFR5B11 | |
| 18842-08061 | PLFR6A | |
| 27400-85011 | IFR7F4D | |
| ISOLATOR | → NGK Typ | V-LINE |
| 6B | BP6HS | V-Line No. 18 |
| 7B | BP6HS | V-Line No. 18 |
| 7D | BP6ES | V-Line No. 4 |
| A5D | BP7EFS | |
| A7D | BP6EFS | V-Line No. 5 |
| FM14145 / 2 | BP5ES | V-Line No. 8 |
| FM14175 / 2 | BP6ES | V-Line No. 4 |
| FM14200 / 2 | BP6ES | V-Line No. 4 |
| FM14225 / 2 | BP7ES | |
| M14145 | B5HS | |
| PM14225 | BP7HS | |
| U7D | BCP6ES | V-Line No. 17 |
| U8D | BCP5ES | V-Line No. 16 |
| ISUZU | → NGK Typ | V-LINE |
| 5-81380001-0 | BPR5ES | V-Line No. 6 |
| 5-81380003-0 | BPR5EIX | |
| 5-81380004-0 | BP6EVX | |
| 5-81380005-0 | BP5ES | V-Line No. 8 |
| 5-81380006-0 | BP6ES | V-Line No. 4 |
| 5-81380007-0 | BP5EY | |
| 5-81380008-0 | BP6EY | |
| 5-81380012-0 | BP5EY | |
| 5-81380013-0 | BP6EY | |
| 5-86003122-0 | ZFR5F-11 | |
| 5-86003124-0 | ZFR6F-11 | |
| 5-86007635-0 | BKR5E-11 | V-Line No. 33 |
| 5-86007636-0 | ZFR5J-11 | |
| 5-86007639-0 | ZFR6J-11 | |
| 5-86007642-0 | ZFR7J-11 | |
| 5-86013957-0 | PZFR5F-13 | |
| 5-86103379-0 | BPR4ES-11 | |



| ISUZU | → NGK Typ | V-LINE |
|---------------|------------------|---------------|
| 5-86103380-0 | BPR5ES-11 | |
| 5-86103381-0 | BPR6ES-11 | V-Line No. 13 |
| 5-86103382-0 | BPR7ES-11 | |
| 5-86103385-0 | PFR5B-11 | |
| 5-86103386-0 | PFR6B-11 | |
| 5-86103387-0 | PFR7B-11 | |
| 5-86103388-0 | PGR4A11 | |
| 5-86103389-0 | PGR5A-11 | |
| 5-86103390-0 | PGR6A-11 | |
| 5-86103391-0 | PGR7A-11 | |
| 5-86121749-0 | BKR5ES-11 | V-Line No. 33 |
| 5-86121750-0 | BKR6ES-11 | V-Line No. 14 |
| 5-86123951-0 | BKR5E-11 | V-Line No. 33 |
| 5-86123952-0 | BKR6E-11 | V-Line No. 14 |
| 5-86123953-0 | BKR7E-11 | |
| 8-94120560-0 | BPR5ES-11 | |
| 8-94120561-0 | BPR5EY-11 | |
| 8-94120562-0 | BPR6EY-11 | V-Line No. 10 |
| 8-94160627-0 | BPR6EY | |
| 8-94217232-0 | BPR6ES-11 | V-Line No. 13 |
| 8-94219943-0 | BPR6ES | V-Line No. 2 |
| 8-94235966-0 | BP5ES-11 | |
| 8-94237203-0 | BP5EY-11 | |
| 8-94241059-0 | BP6ES-11 | |
| 8-94252270-0 | BP6EY-11 | |
| 8-94328372-0 | BKR6E-11 | V-Line No. 14 |
| 8-94328373-0 | BKR7E-11 | |
| 8-94328374-0 | BKR6E-11 | V-Line No. 14 |
| 8-94328375-0 | BKR7E-11 | |
| 8-97012928-0 | BKR6E | V-Line No. 28 |
| 8-97012930-0 | BKR6E | V-Line No. 28 |
| 8-97012931-0 | BKR7E | |
| 8-97111376-0 | PFR5B-11 | |
| 8-97170268-0 | BKR5EVX-11 | |
| 9-82513103-0 | BP6ES | V-Line No. 4 |
| 9-82513106-0 | BP5ES | V-Line No. 8 |
| JAGUAR | → NGK Typ | V-LINE |
| 7R83-12405-AA | TR6AP13E | |
| AJ84575 | IFR5N10 | |
| C2A1535 | IFR5N10 | |
| C2S46895 | TR6AP13E | |
| EAC8554 | BR7EFS | |
| EBC004021 | BR7EF | |
| EBC4021 | BR7EF | |
| NCA3850DA / 2 | BKR6EVXA-11 | |
| NCA3850FA / 2 | BKR6EVXA-13 | |
| NCA3850HA / 2 | PFR6G-13E | |
| KIA | → NGK Typ | V-LINE |
| 0 0259 18 110 | BP6ES | V-Line No. 4 |
| 0 K01A 18 110 | BKR5E | V-Line No. 35 |

| KIA | → NGK Typ | V-LINE |
|---|------------------|---------------|
| 0 K01C 18 110 | BKR6E-11 | V-Line No. 14 |
| 0 K2AA 18 110 | BKR6E | V-Line No. 28 |
| 0 K558 18 110 | PFR6N-11 | |
| 1 8814 11 051 | BKR5E-11 | V-Line No. 33 |
| 1 8814 11 061 | BKR6ES-11 | V-Line No. 14 |
| 1 8840 11 051 | ILFR5B11 | |
| KUBOTA | → NGK Typ | V-LINE |
| 12273-6771-1 | BP5HM | |
| 12392-6771-1 | BP5ES | V-Line No. 8 |
| 12581-6771-1 | BPC6ES-11 | |
| 12647-6771-0 | BPR6HS | V-Line No. 3 |
| 12647-6771-1 | BPR6HS | V-Line No. 3 |
| 12681-6774-0 | BR5ES | |
| 12681-6774-1 | BR5ES | |
| 12691-6771-1 | BCPR4ES-11 | |
| 12863-6771-1 | BP5ES | V-Line No. 8 |
| 12866-6771-1 | BP5ES | V-Line No. 8 |
| 12992-6771-1 | BPR5ES | V-Line No. 6 |
| 13078-6771-6 | BP6ES | V-Line No. 4 |
| 13375-6774-0 | BP5ES | V-Line No. 8 |
| 13901-6771-6 | BP6HS | V-Line No. 18 |
| 13902-6771-1 | BP6HS | V-Line No. 18 |
| LAMBORGHINI => siehe VW Group | | |
| LANCIA => siehe FIAT Group | | |
| LAND ROVER | | |
| 4550157 | IFR5N10 | |
| LR005483 | ILFR6B | |
| LEXUS => siehe TOYOTA | | |
| LODGE | → NGK Typ | V-LINE |
| 15HLNY | BP6ES | V-Line No. 4 |
| 25HL | BPR7ES | V-Line No. 19 |
| 25HLD | BPC6ET | |
| 25HLNY | BP7ES | |
| 25XL | BP6ES | V-Line No. 4 |
| 2BTNY | AP5FS | |
| 2HLD | BPC6ES | V-Line No. 17 |
| 2HLNY | BP7ES | |
| 2HNY | BP7HS | |
| 2HTNY | AP7FS | |
| 2HTY | BP6FS | |
| 2XL | BP6ES | V-Line No. 4 |
| 3BTY | BP4FS | |
| 3HAN / M | B9S | |
| 3HLNY | BP7ES | |
| 3HNY | BP8ES | |
| 4HLNY | BP8ES | |



| LODGE | → NGK Typ | V-LINE |
|----------------------|------------------|---------------|
| 5HLNY | BP8ES | |
| BLNY | BP5ES | V-Line No. 8 |
| BLTY | BPR5EFS | |
| BTNY | AP5FS | |
| BTY | BP5FS | |
| C14 | B5HS | |
| CLNY | BP5ES | V-Line No. 8 |
| CN | B5HS | |
| CNY | BP5HS | |
| CTNY | AP5FS | |
| CTY | BP5FS | |
| HBN | B5HS | |
| HBTNY | AP6FS | |
| HBTY | BP5FS | |
| HLNY | BP6ES | V-Line No. 4 |
| HNY | BP6HS | V-Line No. 18 |
| HT14 | BP5FS | |
| HT18 | AP6FS | |
| HTN | A6FS | |
| HTN18 | A7FS | |
| HTNY | AP6FS | |
| HTY | BP6FS | |
| LOTUS | → NGK Typ | V-LINE |
| A100E6277S | BKR6E | V-Line No. 28 |
| A910E7009F | BPR6EKN | |
| MARCHAL/VALEO | → NGK Typ | V-LINE |
| 23F | A6FS | |
| 34 / 5HS | BP6ES | V-Line No. 4 |
| 35 / 1 | BP6HS | V-Line No. 18 |
| 35 / 1B | BP6HS | V-Line No. 18 |
| 35 / 1D | BP6HS | V-Line No. 18 |
| 35HA | BP6ES | V-Line No. 4 |
| 36 | B5HS | |
| 36B | B5HS | |
| 36D | B5HS | |
| 36M | B5HS | |
| 36P | B5HS | |
| 37S | B5HS | |
| 5N | BP6HS | V-Line No. 18 |
| 5NCYCLO | BP6HS | V-Line No. 18 |
| 64H | BP7ES | |
| 6H | BP7ES | |
| 6N | BP5HS | |
| 70H | BP6ES | V-Line No. 4 |
| 76H | BP5ES | V-Line No. 8 |
| 7H | BP6ES | V-Line No. 4 |
| 84H | BP5ES | V-Line No. 8 |
| 88N | B5HS | |
| 8H | BP6ES | V-Line No. 4 |
| 9H | BP5ES | V-Line No. 8 |

| MARCHAL/VALEO | → NGK Typ | V-LINE |
|----------------------|------------------|---------------|
| C64H | BP6EFS | V-Line No. 5 |
| C68H | BP6EFS | V-Line No. 5 |
| C7H | BP6EFS | V-Line No. 5 |
| F70H | BCP7ES | |
| F74H | BCP6ES | V-Line No. 17 |
| F80H | BCP7ES | |
| GT34 | BP7HS | |
| GT34 / 2H | BP6ES | V-Line No. 4 |
| GT34 / 5 | BP6HS | V-Line No. 18 |
| GT34 / 5D | BP6HS | V-Line No. 18 |
| GT34 / 5H | BP6ES | V-Line No. 4 |
| GT34 / 5HA | BP6ES | V-Line No. 4 |
| GT34 / 5HD | BP6ES | V-Line No. 4 |
| GT34D | BP7HS | |
| GT34H | BP7ES | |
| GT34HD | BP6ES | V-Line No. 4 |
| GT35 | BP5HS | |
| GT35D | BP5HS | |
| GT35H | BP5ES | V-Line No. 8 |
| GT35HD | BP5ES | V-Line No. 8 |
| RR32HS | B9EGV | |
| RR33HSS | B8EGV | |
| SCGT34 / 5H | BP6EFS | V-Line No. 5 |
| SCGT35H | BP6EFS | V-Line No. 5 |
| V36A | B5HS | |
| V6NSOLEX | B5HS | |
| MARELLI | → NGK Typ | V-LINE |
| 061830072304 | BCPR7ES | |
| 061830085304 | BPR7ES | V-Line No. 19 |
| 061830086304 | BKR6E | V-Line No. 28 |
| 061830175304 | BP7ES | |
| 061830176304 | BP6HS | V-Line No. 18 |
| 061830210304 | BP6ES | V-Line No. 4 |
| 061830211304 | BPR6ES | V-Line No. 2 |
| 061830215304 | BP6EFS | V-Line No. 5 |
| 061830254304 | BKR6E | V-Line No. 28 |
| 061830257304 | BPR6HS | V-Line No. 3 |
| 061830258304 | BP5HS | |
| 061830262304 | BPR6EFS | V-Line No. 7 |
| 061850023304 | PTR5A-13 | V-Line No. 25 |
| 062000654304 | BP6HS | V-Line No. 18 |
| 062000739304 | BP6ES | V-Line No. 4 |
| 062000740304 | BPR6ES | V-Line No. 2 |
| 062000754304 | BP6HS | V-Line No. 18 |
| 7LCR | BKR6E | V-Line No. 28 |
| 7LPR | BKR6E | V-Line No. 28 |
| 8LCR | BCPR7ES | |
| 8LDCR | PTR5A-13 | V-Line No. 25 |
| 8LPR | BCPR7ES | |
| CW101L | B85EGV | |
| CW55N | B5HS | |



| MARELLI | → NGK Typ | V-LINE |
|----------------|------------------|---------------|
| CW5LP | BP5ES | V-Line No. 8 |
| CW5N | B5HS | |
| CW5NJ | B5HS | |
| CW5NP | BP5HS | |
| CW5NS | B5HS | |
| CW5NSZ | B5HS | |
| CW67LP | BP6ES | V-Line No. 4 |
| CW67N | BP6HS | V-Line No. 18 |
| CW67P | BP5ES | V-Line No. 8 |
| CW6LP | BP5ES | V-Line No. 8 |
| CW6LR | BR5ES | |
| CW6NP | BP6HS | V-Line No. 18 |
| CW6NPR | BPR6HS | V-Line No. 3 |
| CW75LP | BP6ES | V-Line No. 4 |
| CW78LP | BP6ES | V-Line No. 4 |
| CW78LPR | BPR6ES | V-Line No. 2 |
| CW78LPS | BP6ES | V-Line No. 4 |
| CW7LCR | BKR6E | V-Line No. 28 |
| CW7LP | BP6ES | V-Line No. 4 |
| CW7LPH | BP6ES | V-Line No. 4 |
| CW7LPR | BPR6ES | V-Line No. 2 |
| CW7LR | BR6ES | |
| CW7NP | BP6HS | V-Line No. 18 |
| CW7NPR | BPR6HS | V-Line No. 3 |
| CW89LP | BP7ES | |
| CW8LCR | BCPR7ES | |
| CW8LP | BP7ES | |
| CW8LPR | BPR7ES | V-Line No. 19 |
| CW8LPS | BP7ES | |
| CW8NP | BP7HS | |
| CW9LP | BP8ES | |
| CWP11L | B10EGV | |
| CWP7L | B6EVX | |
| F6NC | BP5HS | |
| F6NCR | BPR5HS | |
| F7LC | BP6ES | V-Line No. 4 |
| F7LCR | BPR6ES | V-Line No. 2 |
| F7NC | BP6HS | V-Line No. 18 |
| F7NCR | BPR6HS | V-Line No. 3 |
| F8LC | BP7ES | |
| F8LCR | BPR7ES | V-Line No. 19 |
| FC6N | B5HS | |
| FC9L | BP8ES | |
| T7LC | BP6EFS | V-Line No. 5 |
| T7LCR | BPR6EFS | V-Line No. 7 |
| T8LC | BP7EFS | |
| TM2NP | AP5FS | |
| TM4NP | AP6FS | |
| TW4LP | BP5EFS | |
| TW5NP | BP5FS | |
| TW6NP | BP6FS | |
| TW78LP | BP6EFS | V-Line No. 5 |

| MARELLI | → NGK Typ | V-LINE |
|----------------|------------------|---------------|
| TW78LPR | BPR6EFS | V-Line No. 7 |
| TW78NPR | BPR6FS | |
| TW7LP | BP6EFS | V-Line No. 5 |
| TW7LPR | BPR6EFS | V-Line No. 7 |
| TW7NP | BP6FS | |

MASERATI => siehe FIAT Group

MAYBACH => siehe MERCEDES

| MAZDA | → NGK Typ | V-LINE |
|---------------|------------------|---------------|
| 0000 18 1690 | BPR6ES | V-Line No. 2 |
| 0000 18 3648 | BR7ET | |
| 0000 18 3649 | BR8ET | |
| 0000 18 8914 | BPR5ES | V-Line No. 6 |
| 0000 18 B601 | BPR5ES-11 | |
| 0000 18 BP01 | BKR5E-11 | V-Line No. 33 |
| 0000 18 BP03 | BKR6E-11 | V-Line No. 14 |
| 0000 18 BP47 | BKR5E | V-Line No. 35 |
| 0000 18 F201 | ZFR6A-11 | |
| 0000 18 F203 | ZFR5A-11 | |
| 0000 18 F285 | ZFR6F-11 | |
| 0000 18 F287 | ZFR5F-11 | |
| 0000 18 JE41 | BKR5EVX-11 | |
| 0000 18 KJ11 | PZFR6F | |
| 0000 18 KJ13 | PZFR5F | |
| 0000 18 KJ15 | PZFR7F | |
| 0000 18 L3Y1 | ILTR6A-13G | |
| 0000 18 L3Y2 | ILTR5A-13G | |
| 0000 18 L3Y3 | ILTR6A8G | |
| 0000 18 N201 | BR8EQ-14 | |
| 0000 18 N203 | BR9EQ-14 | |
| 0000 18 N328 | BUR8EQ | |
| 0000 18 N329 | BUR6EQ | |
| 0000 18 N342 | BUR9EQ | |
| 0000 18 N343 | BUR7EQ | |
| 0000 18 N3A1 | BUR9EQP | |
| 0000 18 N3A2 | BUR7EQP | |
| 0000 18 N3A3 | BUR8EQP | |
| 0000 18 N3A4 | BUR6EQP | |
| 0000 18 N3Y1 | RE9B-T | |
| 0000 18 N3Y2L | RE7C-L | |
| 0000 18 N3Y8 | RE7C-L | |
| 0222 18 110 | BP6EY | |
| 0259 18 110 | BP6ES | V-Line No. 4 |
| 0370 18 110 | BP6EVX | |
| 0371 18 110 | BPR5EIX | |
| 0660 18 110 | BP5ES | V-Line No. 8 |
| 0745 18 110 | BP7ES | |
| 0801 18 600 | BR6EM | |
| 0802 18 600 | BR7EM | |
| 0803 18 600 | BR8EM | |



| MAZDA | → NGK Typ | V-LINE |
|--------------|------------------|---------------|
| 0865 18 600 | B6EM | |
| 0866 18 600 | B7EM | |
| 0867 18 600 | BR8EM | |
| 0868 18 600 | B9EM | |
| 1001 77 550 | BP4EY | |
| 1002 77 550 | BP5EY | |
| 1003 77 550 | BP6EY | |
| 1409 18 110 | BP5ES-13 | |
| 1410 18 110 | BP5ES-13 | |
| 1482 18 600A | BR8EQ | |
| 1483 18 600 | BR8EQ | |
| 1534 18 110 | BP5EY | |
| 1690 18 110 | BPR6ES | V-Line No. 2 |
| 1A01 18 110 | PGR5A | |
| 1A02 18 110 | KR7AI | |
| 1A03 18 110 | IKR7A | |
| 1A04 18 110 | DCPR6E | |
| 1A06 18 110 | DCPR8E | |
| 1A08 18 110 | ZGR5A | V-Line No. 15 |
| 1A10 18 110 | GR5AI-10 | |
| 1A50 18 110 | BKR6E | V-Line No. 28 |
| 1A53 18 110 | BKR6E-11 | V-Line No. 14 |
| 1A61 18 110 | DCPR7EVX | |
| 1N00 18 110 | BKR4E-11 | |
| 1N04 18 110 | BKR5EY-11 | |
| 1N06 18 110 | BKR6EY-11 | |
| 1N07 18 110 | PFR4G-11 | |
| 1N08 18 110 | PFR5G-11 | |
| 1N09 18 110 | PFR6G-11 | |
| 1N11 18 110 | FR7AI-D | |
| 1N18 18 110 | LZKAR5AP11 | |
| 1N19 18 110 | LZKAR6AP-11 | |
| 1N20 18 110 | LZKAR7AP11 | |
| 1N21 18 110 | LFR4AP-11 | |
| 1N22 18 110 | LFR5AP-11 | |
| 1UD0 18 110 | BPR5EIX-11 | |
| 1UD1 18 110 | BPR6EIX-11 | |
| 1UD2 18 110 | BPR7EIX | |
| 1UD3 18 110 | BKR5EIX-11 | |
| 1UD4 18 110 | BKR6EIX-11 | |
| 1UD6 18 110 | BCPR5EIX-11 | |
| 1UD7 18 110 | BCPR6EIX-11 | |
| 1UD9 18 110 | DCPR7EIX | |
| 1UN0 18 110 | BPR5EIX | |
| 1UN1 18 110 | BPR6EIX | |
| 1UN2 18 110 | BPR7EIX | |
| 1UN3 18 110 | BPR5EIX-11 | |
| 1UN4 18 110 | BPR6EIX-11 | |
| 1UN6 18 110 | BKR5EIX | |
| 1UN7 18 110 | BKR6EIX | |
| 1UN9 18 110 | BKR5EIX-11 | |
| 1UNA 18 110 | BKR6EIX-11 | |

| MAZDA | → NGK Typ | V-LINE |
|--------------|------------------|---------------|
| 1UNC 18 110 | BCPR5EIX-11 | |
| 1UND 18 110 | BCPR6EIX-11 | |
| 1UNF 18 110 | DCPR7EIX | |
| 1UNG 18 110 | ZFR5FIX-11 | |
| 1UNH 18 110 | ZFR6FIX-11 | |
| 1UT3 18 110 | BKR5EIX-11P | |
| 1UT6 18 110 | BCPR5EIX-11P | |
| 1UT7 18 110 | BCPR6EIX-11P | |
| 1UX6 18 110 | BKR5EIX-P | |
| 1UX9 18 110 | BKR5EIX-11P | |
| 1UXC 18 110 | BCPR5EIX-11P | |
| 1UXD 18 110 | BCPR6EIX-11P | |
| 1Y00 18 110 | BPR5ES | V-Line No. 6 |
| 1Y01 18 110 | BPR6ES | V-Line No. 2 |
| 1Y03 18 110 | BPR5ES-11 | |
| 1Y06 18 110 | BKR5E | V-Line No. 35 |
| 1Y07 18 110 | BKR6E | V-Line No. 28 |
| 1Y09 18 110 | BKR5E-11 | V-Line No. 33 |
| 1Y0A 18 110 | BKR6E-11 | V-Line No. 14 |
| 1Y0B 18 110 | BKR7E-11 | |
| 1Y0F 18 110 | DCPR7E | |
| 1Y0G 18 110 | ZFR5F-11 | |
| 1Y0H 18 110 | ZFR6F-11 | |
| 1Y0K 18 110 | BPR5ES-13 | |
| 1Y0L 18 110 | BRE527Y-11 | |
| 1YR9 18 110 | BKR5EIX-11P | |
| 2182 18 600 | BR7EM | |
| 2183 18 600 | BR8EM | |
| 2328 18 600 | B7EM | |
| 2359 18 600 | BR8EM | |
| 3648 18 600 | BR7ET | |
| 3649 18 600 | BR8ET | |
| 3710 18 110 | BP6ES-13 | |
| 3743 18 600 | BR7ET | |
| 3744 18 600 | BR8ET | |
| 3953 18 110 | BPR5EY | V-Line No. 9 |
| 3954 18 110 | BPR6EY | |
| 4095 18 110 | BP4EY | |
| 4096 18 110A | BPR4ES-13 | |
| 6M8G12405BB | ILTR5A-13G | |
| 8042 18 110 | BPR6EVX-11 | |
| 8182 18 600 | BR7EQ | |
| 8248 18 600 | BRE813L | |
| 8344 18 600 | BR9ET | |
| 8526 18 600 | B6EM | |
| 8865 18 600 | B6EM | |
| 8914 18 110 | BPR5ES | V-Line No. 6 |
| A501 18 110 | BP6E | V-Line No. 4 |
| A502 18 110 | BP6ES | V-Line No. 4 |
| AY02 18 110 | DCP7E | |
| AY01 18 110 | DCP7E | |
| AZ08 18 110 | BPR5E | V-Line No. 6 |



| MAZDA | → NGK Typ | V-LINE |
|----------------|------------------|---------------|
| AZ09 18 110 | BPR5E | V-Line No. 6 |
| AZ28 18 110 | DCP7EVX | |
| AZ29 18 110 | DCP7EVX | |
| B601 18 110 | BPR5ES-11 | |
| B602 18 110 | BPR5EY-11 | |
| B64N 18 110 | BRE527Y-11 | |
| B64P 18 110 | BRE527Y-11 | |
| B660 18 110 | BKR6E-11 | V-Line No. 14 |
| B667 18 110 | BKR6E-11 | V-Line No. 14 |
| B672 18 110 | BPR5ES | V-Line No. 6 |
| B695 18 110 | BCPR6E | V-Line No. 12 |
| B696 18 110 | BCPR6E | V-Line No. 12 |
| B6B3 18 110 | BCPR5E-11 | |
| B6B4 18 110 | BCPR5E-11 | |
| BBYV 18 110 | R7436-10 | |
| BBYV 18 11Z | R7436-9 | |
| BP01 18 110 | BKR5E-11 | V-Line No. 33 |
| BP02 18 110 | BKR5E-11 | V-Line No. 33 |
| BP03 18 110 | BKR6E-11 | V-Line No. 14 |
| BP04 18 110 | BKR6E-11 | V-Line No. 14 |
| BP05 18 110 | BKR7E-11 | |
| BP06 18 110 | BKR7E-11 | |
| BP07 18 110 | BKR6ES-11 | V-Line No. 14 |
| BP09 18 110 | BKR6ES-11 | V-Line No. 14 |
| BP47 18 110 | BKR5E | V-Line No. 35 |
| BP47 18 110P00 | BKR5E | V-Line No. 35 |
| BP48 18 110 | BKR5E | V-Line No. 35 |
| BP49 18 110 | BKR6E | V-Line No. 28 |
| BP50 18 110 | BKR6E | V-Line No. 28 |
| BP51 18 110 | BKR7E | |
| BPY1 18 110 | BKR5E-11 | V-Line No. 33 |
| BPY3 18 110 | BKR6E-11 | V-Line No. 14 |
| E356 18 110 | BE527Y-11 | |
| E357 18 110 | BE527Y-11 | |
| F201 18 110 | ZFR6A-11 | |
| F202 18 110A | ZFR6A-11 | |
| F203 18 110 | ZFR5A-11 | |
| F204 18 110 | ZFR5A-11 | |
| F205 18 110 | ZFR7F-11 | |
| F210 18 110 | BCPR5E | V-Line No. 32 |
| F211 18 110 | BCPR5E | V-Line No. 32 |
| F220 18 110 | BCPR6E-11 | V-Line No. 11 |
| F221 18 110 | BCPR6EY-11 | |
| F261 18 110 | ZFR6F-11 | |
| F285 18 110 | ZFR6F-11 | |
| F286 18 110 | ZFR6J-11 | |
| F287 18 110 | ZFR5F-11 | |
| F288 18 110 | ZFR5J-11 | |
| F289 18 110 | ZFR7F-11 | |
| F293 18 110 | ZFR5F-11 | |
| F2C5 18 110 | ZFR6F-11 | |
| F2C7 18 110 | ZFR6F-11 | |

| MAZDA | → NGK Typ | V-LINE |
|--------------|------------------|---------------|
| F806 18 110 | BPR4ES-13 | |
| F8B1 18 110 | ZF6A-11 | |
| F8B2 18 110A | ZF6A-11 | |
| F8B3 18 110 | ZFR5F-11 | |
| F8B5 18 110 | ZFR7F-11 | |
| F8B7 18 110 | ZFR4F-11 | |
| F8L6 18 110 | ZFR4F-11 | |
| F8L7 18 110 | ZFR4F-11 | |
| F8L8 18 110 | BPR4ES-13 | |
| F8L9 18 110 | BPR4ES-13 | |
| FE3N 18 110 | BCPR7E-11 | |
| FE6E 18 110 | BCPR7E-11 | |
| FE6F 18 110 | BCPR7E-11 | |
| FE79 18 110 | BPR6ES-11 | V-Line No. 13 |
| FE82 18 110 | BPR6EY-11 | V-Line No. 10 |
| FEDK 18 110 | BPR5ES-13 | |
| FEDM 18 110 | BPR5ES-13 | |
| FEEG 18 110 | BPR6ES-13 | |
| FEEH 18 110 | BPR6EVX-11 | |
| FEFB 18 110 | BPR6ES-11 | V-Line No. 13 |
| JE03 18 110 | BCPR7E | |
| JE26 18 110 | BCPR5EIX-11 | |
| JE27 18 110 | BCPR6EVX-11 | |
| JE28 18 110 | BCPR5EIX-11 | |
| JE41 18 110 | BKR5EVX-11 | |
| JE42 18 110 | BKR5EVX-11 | |
| JE43 18 110 | BKR6EVX-11 | |
| JE44 18 110 | BKR6EVX-11 | |
| JE45 18 110 | BKR7EVX-11 | |
| JE46 18 110 | BKR7EVX-11 | |
| JF03 18 110 | BCPR5E-11 | |
| JF04 18 110 | BCPR5E-11 | |
| KJ11 18 110 | PZFR6F | |
| KJ12 18 110 | PZFR6F | |
| KJ13 18 110 | PZFR5F | |
| KJ14 18 110 | PZFR5F | |
| KJ15 18 110 | PZFR7F | |
| L303 18 110 | ITR5F13 | |
| L341 18 110 | ITR6F13 | |
| L3G2 18 110 | ILTR6A-13G | |
| L3K9 18 110 | ILTR6A8G | |
| L3K9 18 110A | ILTR6A8G | |
| L3Y1 18 110 | ILTR6A-13G | |
| L3Y2 18 110 | ILTR5A-13G | |
| L3Y3 18 110 | ILTR6A8G | |
| L3Y4 18 110 | ITR6F13 | |
| L813 18 110 | ITR6F13 | |
| L814 18 110 | BPR6EF-13 | |
| LFG1 18 110 | ILTR5A-13G | |
| LFY1 18 110 | TR5B-13 | |
| LFY3 18 110 | BPR5EFS-13 | |
| N201 18 600 | BR8EQ-14 | |



| MAZDA | → NGK Typ | V-LINE |
|----------------|------------------|---------------|
| N202 18 600 | BR8EQ-14 | |
| N203 18 600 | BR9EQ-14 | |
| N212 18 600 | BR7EQ-14 | |
| N212 18 600A | BR7EQ-14 | |
| N218 18 600 | BR8EQ-14 | |
| N225 18 600A | BUR9EQ | |
| N236 18 600 | BUR9EQ | |
| N238 18 600 | BUR8EQ | |
| N245 18 600 | SD10A | |
| N246 18 600 | BR9EQ-14 | |
| N253 18 600 | BR9EQ-14 | |
| N322 18 110 | BR10ET | |
| N328 18 110 | BUR8EQ | |
| N329 18 110 | BUR6EQ | |
| N331 18 110 | SD10A | |
| N333 18 110 | SD11A | |
| N335 18 110 | SD9A | |
| N338 18 110 | SD11A | |
| N339 18 110 | SD10A | |
| N340 18 110 | BUR9EQ | |
| N341 18 110 | BUR7EQ | |
| N342 18 110 | BUR9EQ | |
| N343 18 110 | BUR7EQ | |
| N390 18 110 | BUR5EQ | |
| N3A1 18 110 | BUR9EQP | |
| N3A2 18 110 | BUR7EQP | |
| N3A3 18 110 | BUR8EQP | |
| N3A4 18 110 | BUR6EQP | |
| N3H1 18 110C | RE9B-T | |
| N3H1 18 110D | RE9B-T | |
| N3H2 18 110C | RE7C-L | |
| N3H5 18 110 | RE7C-L | |
| N3H5 18 110A | RE7C-L | |
| N3H8 18 110A | RE9B-T | |
| N3H8 18 110B | RE9B-T | |
| N3H9 18 110A | RE8C-L | |
| N3J1 18 110 | RE8C-L | |
| N3J1 18 110A | RE8C-L | |
| N3M1 18 1BXA | RE7C-L | |
| N3M1 18 1BXB | RE7C-L | |
| N3Y1 18 110 | RE9B-T | |
| N3Y1 18 110A | RE9B-T | |
| N3Y1 18 110A9U | RE9B-T | |
| N3Y1 18 S30 | RE7C-L | |
| N3Y1 18 S30 | RE9B-T | |
| N3Y1 18 S30L | RE7C-L | |
| N3Y1 18 S30T | RE9B-T | |
| N3Y2 18 110 | RE7C-L | |
| N3Y2 18 110L | RE7C-L | |
| N3Y2 18 S30 | RE8C-L | |
| N3Y2 18 S30 | RE9B-T | |
| N3Y2 18 S30L | RE8C-L | |

| MAZDA | → NGK Typ | V-LINE |
|----------------|------------------|---------------|
| N3Y2 18 S30T | RE9B-T | |
| N3Y3 18 S30 | RE7C-L | |
| N3Y3 18 S30 | RE9B-T | |
| N3Y4 18 110 | RE9B-T | |
| N3Y4 18 110A | RE9B-T | |
| N3Y4 18 S30 | RE8C-L | |
| N3Y4 18 S30 | RE9B-T | |
| N3Y5 18 110 | RE8C-L | |
| N3Y5 18 110L | RE8C-L | |
| N3Y6 18 110 | RE7C-L | |
| N3Y6 18 110L | RE7C-L | |
| N3Y8 18 110 | RE7C-L | |
| N3Y8 18 110A | RE7C-L | |
| N3Y8 18 110A9U | RE7C-L | |
| N3Z1 18 110 | RE8C-L | |
| N3Z1 18 110A | RE8C-L | |
| N3Z2 18 110 | RE7C-L | |
| N3Z2 18 110A | RE7C-L | |
| N3Z4 18 110 | RE7C-L | |
| N3Z5 18 110 | RE8C-L | |
| PBP01 18 110AA | BKR5E-11 | V-Line No. 33 |
| TF50 18 110 | BKR6EVX | |
| Z601 18 110 | BKR5EIX-11P | |
| ZR03 18 110 | R6725-115 | |
| ZZS1 18 110 | DCPR7E | |
| ZZS2 18 110 | DCPR7E | |
| ZZS4 18 110 | BPR5EY | V-Line No. 9 |
| ZZSI 18 110 | DCPR7E | |

| MERCEDES | → NGK Typ | V-LINE |
|-----------------|------------------|---------------|
| 000 308 5V 005 | BKR6EKE | |
| 001 246 8V 001 | LKR8A | |
| 001 246 8V 002 | LKR8A | |
| 002 159 18 03 | BP7ES | |
| 002 159 22 03 | BP5ES | V-Line No. 8 |
| 002 159 24 03 | BP6ES | V-Line No. 4 |
| 002 159 27 03 | BP7ES | |
| 002 159 28 03 | BP6ES | V-Line No. 4 |
| 002 159 29 03 | BP5ES | V-Line No. 8 |
| 002 159 31 03 | BP5ES | V-Line No. 8 |
| 002 159 41 03 | BP6ES | V-Line No. 4 |
| 002 159 42 03 | BP6ES | V-Line No. 4 |
| 002 159 48 03 | BP5ES | V-Line No. 8 |
| 002 159 49 03 | BP6EFS | V-Line No. 5 |
| 002 159 56 03 | BP6EFS | V-Line No. 5 |
| 002 159 57 03 | BP5EFS | |
| 002 159 58 03 | BP5EFS | |
| 002 159 64 03 | BP7EFS | |
| 002 159 65 03 | BP7EFS | |
| 002 159 68 03 | BP6EFS | V-Line No. 5 |
| 002 159 69 03 | BP6EFS | V-Line No. 5 |
| 002 159 76 03 | BP5EFS | |



| MERCEDES | → NGK Typ | V-LINE |
|------------------|------------------|---------------|
| 002 159 77 03 | BCP5ES | V-Line No. 16 |
| 003 159 04 03 | BP5EFS | |
| 003 159 05 03 | BP5EFS | |
| 003 159 06 03 | BP6EFS | V-Line No. 5 |
| 003 159 07 03 | BP6EFS | V-Line No. 5 |
| 003 159 08 03 | BP7EFS | |
| 003 159 10 03 | BP5ESZ | |
| 003 159 11 03 | BP5ESZ | |
| 003 159 12 03 | BP6ESZ | |
| 003 159 13 03 | BP6ESZ | |
| 003 159 14 03 | BP7ES | |
| 003 159 16 03 | BCP6ES | V-Line No. 17 |
| 003 159 30 03 | BCP5ES | V-Line No. 16 |
| 003 159 31 03 | BCP6ES | V-Line No. 17 |
| 003 159 33 03 | BP7EFS | |
| 003 159 34 03 | BP6EFS | V-Line No. 5 |
| 003 159 35 03 | BP6EFS | V-Line No. 5 |
| 003 159 36 03 | BP5EFS | |
| 003 159 37 03 | BCP5ES | V-Line No. 16 |
| 003 159 40 03 | BP5EFS | |
| 003 159 41 03 | BP5EFS | |
| 003 159 42 03 | BCP5ES | V-Line No. 16 |
| 003 159 45 03 | BP6ESZ | |
| 003 159 46 03 | BP5ESZ | |
| 003 159 47 03 | BP5ESZ | |
| 003 159 56 03 | BP7ES | |
| 003 159 57 03 | BP6ESZ | |
| 003 159 78 03 | BKR6ES | V-Line No. 28 |
| 003 159 90 03 | BKUR5ET | V-Line No. 29 |
| 003 159 91 03 | BKR5EKUP | |
| 003 159 92 03 | BKR6EKE | |
| 003 159 94 03 | PFR5R-11 | |
| 003 159 96 03 | IFR5D10 | |
| 003 159 96 03 26 | IFR5D10 | |
| 003 159 97 03 | IFR6D10 | |
| 003 159 97 03 26 | IFR6D10 | |
| 004 159 13 03 | ILFR6A | |
| 004 159 14 03 | IFR6Q-G | |
| 004 159 15 03 | LKR8A | |
| 004 159 19 03 | IFR5D10 | |
| 004 159 25 03 | SILZKR7A-S | |
| 004 159 25 63 | SILZKR7A-S | |
| 004 159 30 03 | BKR6EZB | |
| 004 159 36 03 | BKR6EZB | |
| 004 159 39 03 | ILZKAR7A10 | |
| 004 159 49 03 | PLKR7A | |
| 122 159 00 03 | ILZFR6C-K | |
| 132 159 00 03 | LKR7B-9 | |
| A 002 159 18 03 | BP7ES | |
| A 002 159 22 03 | BP5ES | V-Line No. 8 |
| A 002 159 24 03 | BP6ES | V-Line No. 4 |
| A 002 159 27 03 | BP7ES | |

| MERCEDES | → NGK Typ | V-LINE |
|--------------------|------------------|---------------|
| A 002 159 28 03 | BP6ES | V-Line No. 4 |
| A 002 159 29 03 | BP5ES | V-Line No. 8 |
| A 002 159 31 03 | BP5ES | V-Line No. 8 |
| A 002 159 41 03 | BP6ES | V-Line No. 4 |
| A 002 159 42 03 | BP6ES | V-Line No. 4 |
| A 002 159 48 03 | BP5ES | V-Line No. 8 |
| A 002 159 49 03 | BP6EFS | V-Line No. 5 |
| A 002 159 56 03 | BP6EFS | V-Line No. 5 |
| A 002 159 57 03 | BP5EFS | |
| A 002 159 58 03 | BP5EFS | |
| A 002 159 64 03 | BP7EFS | |
| A 002 159 65 03 | BP7EFS | |
| A 002 159 68 03 | BP6EFS | V-Line No. 5 |
| A 002 159 69 03 | BP6EFS | V-Line No. 5 |
| A 002 159 76 03 | BP5EFS | |
| A 002 159 77 03 | BCP5ES | V-Line No. 16 |
| A 003 159 04 03 | BP5EFS | |
| A 003 159 05 03 | BP5EFS | |
| A 003 159 06 03 | BP6EFS | V-Line No. 5 |
| A 003 159 07 03 | BP6EFS | V-Line No. 5 |
| A 003 159 08 03 | BP7EFS | |
| A 003 159 10 03 | BP5ESZ | |
| A 003 159 11 03 | BP5ESZ | |
| A 003 159 12 03 | BP6ESZ | |
| A 003 159 13 03 | BP6ESZ | |
| A 003 159 14 03 | BP7ES | |
| A 003 159 16 03 | BCP6ES | V-Line No. 17 |
| A 003 159 30 03 | BCP5ES | V-Line No. 16 |
| A 003 159 31 03 | BCP6ES | V-Line No. 17 |
| A 003 159 33 03 | BP7EFS | |
| A 003 159 34 03 | BP6EFS | V-Line No. 5 |
| A 003 159 35 03 | BP6EFS | V-Line No. 5 |
| A 003 159 36 03 | BP5EFS | |
| A 003 159 37 03 | BCP5ES | V-Line No. 16 |
| A 003 159 40 03 | BP5EFS | |
| A 003 159 41 03 | BP5EFS | |
| A 003 159 42 03 | BCP5ES | V-Line No. 16 |
| A 003 159 45 03 | BP6ESZ | |
| A 003 159 46 03 | BP5ESZ | |
| A 003 159 47 03 | BP5ESZ | |
| A 003 159 56 03 | BP7ES | |
| A 003 159 57 03 | BP6ESZ | |
| A 003 159 78 03 | BKR6ES | V-Line No. 28 |
| A 003 159 90 03 | BKUR5ET | V-Line No. 29 |
| A 003 159 91 03 | BKR5EKUP | |
| A 003 159 92 03 | BKR6EKE | |
| A 003 159 94 03 | PFR5R-11 | |
| A 003 159 96 03 | IFR5D10 | |
| A 003 159 96 03 26 | IFR5D10 | |
| A 003 159 97 03 | IFR6D10 | |
| A 003 159 97 03 26 | IFR6D10 | |
| A 004 159 13 03 | ILFR6A | |



| MERCEDES | → NGK Typ | V-LINE |
|-----------------|------------------|---------------|
| A 004 159 14 03 | IFR6Q-G | |
| A 004 159 15 03 | LKR8A | |
| A 004 159 19 03 | IFR5D10 | |
| A 004 159 25 03 | SILZKR7A-S | |
| A 004 159 25 63 | SILZKR7A-S | |
| A 004 159 30 03 | BKR6EZB | |
| A 004 159 36 03 | BKR6EZB | |
| A 004 159 39 03 | ILZKAR7A10 | |
| A 004 159 49 03 | PLKR7A | |
| A 122 159 00 03 | ILZFR6C-K | |
| A 132 159 00 03 | LKR7B-9 | |

MG => siehe ROVER

MINI => siehe BMW

| MITSUBISHI | → NGK Typ | V-LINE |
|-------------------|------------------|---------------|
| 1822A002 | IFR6B-K | |
| 1822A005 | ILZFR6C-K | |
| 1822A011 | ILKR7B8 | |
| 1822A022 | ILFR7H | |
| 1822A036 | LKR7B-9 | |
| 1822A068 | DIFR5C11 | |
| 1822A079 | DILKR8B6 | |
| 1822A085 | DILFR5A11 | |
| MD 313 442 | PFR5G-11 | |
| MD 313 443 | PFR6G-11 | |
| MD 314 766 | BKR7EKC-N | |
| MD 319 517 | PFR6G | |
| MD 320 543 | BKR7EKC-N-11 | |
| MD 320 572 | BKR5E | V-Line No. 35 |
| MD 321 150 | BKR6EKC-N-11 | |
| MD 322 771 | PFR6B-11 | |
| MD 331 057 | ZFR5F-11 | |
| MD 336 367 | IZFR6B | |
| MD 338 492 | BPR4ES | |
| MD 338 991 | PGR7A | |
| MD 342 386 | PZFR5F-11 | |
| MD 343 277 | PGR6A | |
| MD 348 296 | PZFR5B | |
| MD 351 467 | PZFR5C | |
| MD 355 067 | BKR6EKUC | |
| MD 357 531 | PFR6J | |
| MD 358 200 | ZFR6F-11 | |
| MD 358 201 | ZFR6F-11 | |
| MD 358 202 | ZFR6F-11 | |
| MD 360 019 | IZFR6B | |
| MD 360 383 | IZFR5B | |
| MD 361 067 | IFR5E11 | |
| MD 362 097 | ZFR5F-11 | |
| MD 362 098 | ZFR5F-11 | |
| MD 362 902 | BKR5EKUC | |

| MITSUBISHI | → NGK Typ | V-LINE |
|-------------------|------------------|---------------|
| MD 365 108 | BPR5EKU | |
| MD 366 819 | IZFR5C | |
| MD 371 434 | IGR7A | |
| MD 371 435 | IGR7A | |
| MD 372 421 | BKR5EKUD | |
| MD 372 422 | BKR6EKUD | |
| MD 372 553 | IFR5E11 | |
| MD 372 588 | IFR6E11 | |
| MD 373 645 | IFR6E11 | |
| MD 374 841 | IGR7A-G | |
| MD 375 642 | BKR5ETUA | |
| MD 378 582 | IFR6B | |
| MM 431 439 | Y-142T | |
| MN 119 256 | ILZFR5B | |
| MN 119 500 | IGR6A11 | |
| MN 158 596 | LZFR6AI | |
| MN 163 236 | FR6EI | |
| MN 163 807 | FR6EI | |
| MN 176 628 | ILZFR6C-11K | |
| MN 195 922 | ILZFR6C-11K | |
| MS 851 022 | BP5ES | V-Line No. 8 |
| MS 851 023 | BP6ES | V-Line No. 4 |
| MS 851 024 | BP7ES | |
| MS 851 027 | BP5ES-11 | |
| MS 851 028 | BP6ES-11 | |
| MS 851 029 | BP7ES-11 | |
| MS 851 097 | BP5EY | |
| MS 851 101 | BP4EY | |
| MS 851 102 | BP5EY | |
| MS 851 104 | BP6EY | |
| MS 851 106 | BP4EY-11 | |
| MS 851 107 | BP5EY-11 | |
| MS 851 108 | BP6EY-11 | |
| MS 851 126 | BPR6E | V-Line No. 2 |
| MS 851 132 | B5HS | |
| MS 851 182 | BP5ES | V-Line No. 8 |
| MS 851 182 A | BP5ES | V-Line No. 8 |
| MS 851 183 | BP6ES | V-Line No. 4 |
| MS 851 184 | BP7ES | |
| MS 851 187 | BP5ES-11 | |
| MS 851 188 | BP6ES-11 | |
| MS 851 189 | BP7ES-11 | |
| MS 851 192 | BP6ES | V-Line No. 4 |
| MS 851 207 | BP5ES-11 | |
| MS 851 208 | BP6ES-11 | |
| MS 851 212 | BP5ES | V-Line No. 8 |
| MS 851 213 | BP6ES | V-Line No. 4 |
| MS 851 215 | BP7ES | |
| MS 851 217 | BPR5ES | V-Line No. 6 |
| MS 851 218 | BPR6ES | V-Line No. 2 |
| MS 851 219 | BPR7ES | V-Line No. 19 |
| MS 851 227 | BPR5ES-11 | |



| MITSUBISHI | → NGK Typ | V-LINE |
|-------------------|------------------|---------------|
| MS 851 228 | BPR6ES-11 | V-Line No. 13 |
| MS 851 229 | BPR7ES-11 | |
| MS 851 230 | BPR4ES-11 | |
| MS 851 232 | BPR5ES | V-Line No. 6 |
| MS 851 233 | BPR6ES | V-Line No. 2 |
| MS 851 234 | BPR7ES | V-Line No. 19 |
| MS 851 235 | BPR5ES | V-Line No. 6 |
| MS 851 236 | BPR6ES | V-Line No. 2 |
| MS 851 237 | BPR5ES-11 | |
| MS 851 238 | BPR6ES-11 | V-Line No. 13 |
| MS 851 239 | BPR7ES-11 | |
| MS 851 242 | BP4EY | |
| MS 851 243 | BP5EY | |
| MS 851 244 | BP6EY | |
| MS 851 246 | BP4EY-11 | |
| MS 851 247 | BP5EY-11 | |
| MS 851 248 | BP6EY-11 | |
| MS 851 253 | BUR6EA-11 | |
| MS 851 254 | BUR7EA-11 | |
| MS 851 272 | BUR5EA-11 | |
| MS 851 273 | BUR6EA-11 | |
| MS 851 274 | BUR7EA-11 | |
| MS 851 283 | BP6E | V-Line No. 4 |
| MS 851 286 | BP5EY | |
| MS 851 287 | BP6EY | |
| MS 851 292 | PGR6A-11 | |
| MS 851 301 | PGR5A-11 | |
| MS 851 302 | PGR6A-11 | |
| MS 851 316 | DCPR6E | |
| MS 851 317 | DCPR7E | |
| MS 851 327 | DCPR7EVX | |
| MS 851 332 | PFR6B-11 | |
| MS 851 335 | PFR5J-11 | |
| MS 851 336 | PFR6J-11 | |
| MS 851 346 | PFR6M | |
| MS 851 347 | PFR7M | |
| MS 851 351 | BK5E | |
| MS 851 352 | BK6E | |
| MS 851 353 | BK6E | |
| MS 851 354 | BK5E | |
| MS 851 357 | BKR5E-11 | V-Line No. 33 |
| MS 851 358 | BKR6E-11 | V-Line No. 14 |
| MS 851 359 | BKR7E-11 | |
| MS 851 361 | BK5E-11 | |
| MS 851 362 | BK6E-11 | |
| MS 851 363 | BK7E-11 | |
| MS 851 364 | BK5E-11 | |
| MS 851 365 | BK6E-11 | |
| MS 851 366 | BK7E-11 | |
| MS 851 367 | BKR5E | V-Line No. 35 |
| MS 851 368 | BKR6E | V-Line No. 28 |
| MS 851 382 | BKR6E | V-Line No. 28 |

| MITSUBISHI | → NGK Typ | V-LINE |
|-------------------|------------------|---------------|
| MS 851 387 | BKR5E-11 | V-Line No. 33 |
| MS 851 388 | BKR6E-11 | V-Line No. 14 |
| MS 851 396 | DCPR6E | |
| MS 851 397 | DCPR7E | |
| MS 851 402 | BPR5E | V-Line No. 6 |
| MS 851 403 | BPR6ES-11 | V-Line No. 13 |
| MS 851 408 | BPR6ES-11 | V-Line No. 13 |
| MS 851 412 | BPR5ES | V-Line No. 6 |
| MS 851 413 | BPR6ES | V-Line No. 2 |
| MS 851 414 | BPR7ES | V-Line No. 19 |
| MS 851 417 | BPR5ES-11 | |
| MS 851 418 | BPR6ES-11 | V-Line No. 13 |
| MS 851 419 | BPR7ES-11 | |
| MS 851 428 | BUR6EA-11 | |
| MS 851 429 | BUR7EA-11 | |
| MS 851 437 | BP5EY | |
| MS 851 438 | BP6ES | V-Line No. 4 |
| MS 851 439 | BP7ES | |
| MS 851 447 | BUR6EA-11 | |
| MS 851 448 | BUR5EA-11 | |
| MS 851 463 | PGR6A-11 | |
| MS 851 473 | PFR6B-11 | |
| MS 851 478 | BPR6ES-11 | V-Line No. 13 |
| MS 851 486 | DCPR6E | |
| MS 851 487 | DCPR7E | |
| MS 851 497 | DCPR7EVX | |
| MS 851 501 | PFR5J-11 | |
| MS 851 502 | PFR6J-11 | |
| MS 851 506 | PFR6J | |
| MS 851 721 | BK5E | |
| MS 851 722 | BK6E | |
| MS 851 727 | BKR5E-11 | V-Line No. 33 |
| MS 851 728 | BKR6E-11 | V-Line No. 14 |
| MS 851 729 | BKR7E-11 | |
| MS 851 732 | BK6E-11 | |
| MS 851 737 | BKR5E | V-Line No. 35 |
| MS 851 738 | BKR6E | V-Line No. 28 |
| MS 851 783 | BK7EK-N-11 | |
| MS 851 861 | PFR6J | |
| MS 851 872 | BK7EK-N-11 | |
| MS 851 881 | BPR6EKN | |
| MS 851 882 | BPR7EKN | |
| MZ 602 020 | BKR5EIX-11 | |
| MZ 602 021 | BKR6EIX-11 | |
| MZ 602 026 | BCPR5EIX-11 | |
| MZ 602 027 | BCPR6EIX-11 | |
| MZ 602 032 | BPR5EIX-11 | |
| MZ 602 033 | BPR6EIX-11 | |
| MZ 602 034 | BPR7EIX | |
| MZ 602 037 | DCPR7EIX | |
| MZ 602 040 | BKR5EIX-11P | |
| MZ 602 043 | BCPR5EIX-11P | |



| MITSUBISHI | → NGK Typ | V-LINE |
|-------------------|------------------|---------------|
| MZ 602 044 | BCPR6EIX-11P | |
| MZ 602 060 | BPR5EIX-11 | |
| MZ 602 061 | BPR6EIX-11 | |
| MZ 602 062 | BPR7EIX | |
| MZ 602 063 | BCPR5EIX-11 | |
| MZ 602 064 | BCPR6EIX-11 | |
| MZ 602 065 | BKR5EIX-11 | |
| MZ 602 066 | BKR6EIX-11 | |
| MZ 602 067 | DCPR7EIX | |
| MZ 602 068 | ZFR5FIX-11 | |
| MZ 602 069 | ZFR6FIX-11 | |
| MZ 602 070 | BPR5EIX | |
| MZ 602 071 | BPR6EIX | |
| MZ 602 072 | BKR5EIX | |
| MZ 602 073 | BKR6EIX | |
| MZ 602 074 | LPG2 | |
| MZ 602 075 | LPG1 | |
| MZ 602 076 | BKR5EIX-11P | |
| MZ 602 078 | BCPR5EIX-11P | |
| MZ 602 079 | BCPR6EIX-11P | |
| MZ 602 081 | BKR7EIX-11 | |
| MZ 602 082 | BKR5EIX-P | |
| SM D31 344 3 | PFR6G-11 | |
| SM N15 859 6 | LZFR6AI | |
| SS MS8 513 64 | BK5E-11 | |
| Z2 152 944 | BPR6ES-11 | V-Line No. 13 |
| Z2 152 945 | BPR6ES | V-Line No. 2 |
| Z2 152 947 | BPR7ES | V-Line No. 19 |
| Z2 152 948 | BPR7ES-11 | |
| Z2 152 949 | BCPR7ES-11 | |
| Z2 152 950 | BCPR6ES-11 | V-Line No. 11 |
| MOTORCRAFT | → NGK Typ | V-LINE |
| 1Y00 | BPR5ES | V-Line No. 6 |
| 1Y01 | BPR6ES | V-Line No. 2 |
| 1Y03 | BPR5ES-11 | |
| 1Y06 | BKR5E | V-Line No. 35 |
| 1Y07 | BKR6E | V-Line No. 28 |
| 1Y09 | BKR5E-11 | V-Line No. 33 |
| 1Y0A | BKR6E-11 | V-Line No. 14 |
| 1Y0B | BKR7E-11 | |
| 1Y0F | DCPR7E | |
| 1Y0G | ZFR5F-11 | |
| 1Y0H | ZFR6F-11 | |
| 1Y0K | BPR5ES-13 | |
| 1Y0L | BRE527Y-11 | |
| 1YR9 | BKR5EIX-11P | |
| AE22 | BP6HS | V-Line No. 18 |
| AE22C | BP6HS | V-Line No. 18 |
| AE32 | BP6HS | V-Line No. 18 |
| AE32C | BP6HS | V-Line No. 18 |
| AE4 | B5HS | |

| MOTORCRAFT | → NGK Typ | V-LINE |
|-------------------|------------------|---------------|
| AE42 | BP5HS | |
| AE4X | B5HS | |
| AE52 | BP5HS | |
| AE6 | B5HS | |
| AE62 | BP5HS | |
| AER32 | BPR6HS | V-Line No. 3 |
| AF12 | BP7FS | |
| AF2 | B7FS | |
| AF22 | BP6FS | |
| AF32 | BP6FS | |
| AF42 | BP5FS | |
| AF52 | BP4FS | |
| AG12 | BP7ES | |
| AG12C | BP7ES | |
| AG12CU | BP7ES | |
| AG203 | B11EGP | |
| AG22 | BP6ES | V-Line No. 4 |
| AG224 | BP6ES-11 | |
| AG22C | BP6ES | V-Line No. 4 |
| AG22CU | BP6ES | V-Line No. 4 |
| AG23 | B7ECS | |
| AG252 | BP6ES | V-Line No. 4 |
| AG252C | BP6ES | V-Line No. 4 |
| AG25C | B7EM | |
| AG32A | BP6ES | V-Line No. 4 |
| AG32C | BP6ES | V-Line No. 4 |
| AG32CU | BP6ES | V-Line No. 4 |
| AG34CU | BP6EY | |
| AG34CU11 | BP6EY-11 | |
| AG403 | B10EGP | |
| AG403C | B10EGP | |
| AG42 | BP5ES | V-Line No. 8 |
| AG42CU | BP5ES | V-Line No. 8 |
| AG44 | ZGR5C | |
| AG44CU | BP5EY | |
| AG501X | B10EGV | |
| AG52 | BP5ES | V-Line No. 8 |
| AG54 | ZGR5C | |
| AG54CU | BP4EY | |
| AG701X | B9EGV | |
| AG901X | B8EGV | |
| AG902 | BP8ES | |
| AGF12 | BP7EFS | |
| AGF12C | BP7EFS | |
| AGF22C | BP6EFS | V-Line No. 5 |
| AGF32CU | BP6EFS | V-Line No. 5 |
| AGFS22C1 | BPR6EFS | V-Line No. 7 |
| AGFS22FE1 | PTR6F-13 | |
| AGFS22IPJ | ITR6F13 | |
| AGFS22YPC | ITR6F13 | |
| AGFS32C1 | BPR6EFS | V-Line No. 7 |
| AGN42 | BP5ES | V-Line No. 8 |



| MOTORCRAFT | → NGK Typ | V-LINE |
|-------------------|------------------|---------------|
| AGP12C | BCP7ES | |
| AGP22C | BCP6ES | V-Line No. 17 |
| AGP701C | R7436-10 | |
| AGPR12C | BCPR7ES | |
| AGPR12P | BKR7EVX-11 | |
| AGPR12PP | PFR7B-11 | |
| AGPR12PP11 | PFR7B-11 | |
| AGPR12PP8 | PFR7B | |
| AGPR22C | BKR6ES | V-Line No. 28 |
| AGPR22C1 | BKR6ES-11 | V-Line No. 14 |
| AGPR22CD | BKR6ES | V-Line No. 28 |
| AGPR22CD1 | BKR6ES-11 | V-Line No. 14 |
| AGPR22P | BKR6EVX-11 | |
| AGPR22PP | PFR6B-11 | |
| AGPR22PPJ | PFR6B-11 | |
| AGPR32C | BKR6ES | V-Line No. 28 |
| AGPR32CD1 | BKR6ES-11 | V-Line No. 14 |
| AGPR32PD | BKR5EKUP | |
| AGPR902C | BCPR9ES-11 | |
| AGPR902P | R7436-9 | |
| AGPS12C | BCPR7ES | |
| AGPS12P1 | BKR7EVX-11 | |
| AGPS22C | BKR6ES | V-Line No. 28 |
| AGPS22C1 | BKR6ES-11 | V-Line No. 14 |
| AGPS22P | BKR6EVX-11 | |
| AGPS22P1 | BKR6EVX-11 | |
| AGPS22PP1 | PFR6B-11 | |
| AGPS32C | BKR6ES | V-Line No. 28 |
| AGPS32C1 | BKR6ES-11 | V-Line No. 14 |
| AGPS44F | PZFR5D-11 | V-Line No. 34 |
| AGPS44F11 | PZFR5D-11 | V-Line No. 34 |
| AGPS44F11J | PZFR5D-11 | V-Line No. 34 |
| AGR12C | BPR7ES | V-Line No. 19 |
| AGR16C | BR8ET | |
| AGR21 | BR6ES | |
| AGR22 | BPR6ES | V-Line No. 2 |
| AGR22C | BPR6ES | V-Line No. 2 |
| AGR22CU | BPR6ES | V-Line No. 2 |
| AGR31 | BR6ES | |
| AGR32 | BPR6ES | V-Line No. 2 |
| AGR32C | BPR6ES | V-Line No. 2 |
| AGR32CU | BPR6ES | V-Line No. 2 |
| AGR34CU | BPR6EY | |
| AGR3X | BR6ES | |
| AGR41 | BR5ES | |
| AGR42 | BPR5ES | V-Line No. 6 |
| AGR42C | BPR5ES | V-Line No. 6 |
| AGR42CU | BPR5ES | V-Line No. 6 |
| AGR44CU | BPR5EY | V-Line No. 9 |
| AGR44CU11 | BPR5EY-11 | |
| AGR47CU11 | ZGR5B-11 | |
| AGR51 | BR5ES | |

| MOTORCRAFT | → NGK Typ | V-LINE |
|-------------------|------------------|---------------|
| AGR52 | BPR5ES | V-Line No. 6 |
| AGR54CU | BPR5EY | V-Line No. 9 |
| AGR82 | BPR4ES | |
| AGRF22 | BPR6EFS | V-Line No. 7 |
| AGRF226 | BPR6EFS-13 | |
| AGRF22C | BPR6EFS | V-Line No. 7 |
| AGRF22C1 | BPR6EFS | V-Line No. 7 |
| AGRF22PP1 | PTR5D-10 | V-Line No. 31 |
| AGRF32 | BPR6EFS | V-Line No. 7 |
| AGRF326 | BPR6EFS-13 | |
| AGRF32C1 | BPR6EFS | V-Line No. 7 |
| AGRF42 | BPR5EFS | |
| AGRF52 | BPR5EFS | |
| AGRP52 | ZFR4F-11 | |
| AGS22C | BPR6ES | V-Line No. 2 |
| AGS32C | BPR5ES | V-Line No. 6 |
| AGS32C11 | BPR5ES-11 | |
| AGS42CC | BPR4ES | |
| AGSF22FM1 | BPR5EFVX | |
| AGSF22FSCM | PTR6D-13G | |
| AGSF22PGM | PTR6F-13 | |
| AGSF22PM | PTR6F-13 | |
| AGSF22PP | PTR6F-13 | |
| AGSF22PPJ | PTR6F-13 | |
| AGSF22PPM | PTR6F-13 | |
| AGSF22WM | BPR5EFS | |
| AGSF22YPC | ITR6F13 | |
| AGSF24C | TR5-1 | |
| AGSF24N | TR55-1 | |
| AGSF32C | BPR5EFS | |
| AGSF32FEC | PTR5F-11 | |
| AGSF32FEM | PTR5D-10 | V-Line No. 31 |
| AGSF32FM | PTR5D-13 | |
| AGSF32W | TR55IX | |
| AGSF32WM | ITR6F13 | |
| AGSF32YPC | ITR5F13 | |
| AGSF34C | TR5-1 | |
| AGSP32 | BKR6ES-11 | V-Line No. 14 |
| AGSP32C | BKR6ES-11 | V-Line No. 14 |
| AGSP32FP | PFR5G-11 | |
| AGSP32PR | PFR6B-11 | |
| AGSP33C | ZFR6F-11 | |
| AGSP52 | BKR5ES | V-Line No. 35 |
| ARF22 | BPR6FS | |
| ARF22C | BPR6FS | |
| ARF22CU | BPR6FS | |
| ARF32 | BPR6FS | |
| ARF326 | BPR6FS | |
| ARF32C6 | BPR6FS | |
| ARF32M | BPR6FS | |
| ARF4 | BR5FS | |
| ARF41CU15 | BR5FS | |



| MOTORCRAFT | → NGK Typ | V-LINE |
|-------------------|------------------|---------------|
| ARF42 | BPR5FS | |
| ARF426 | BPR5FS-15 | |
| ARF42CU | BPR5FS | |
| ARF46 | BR5FS | |
| ARF52 | BPR4FS | |
| ARF526 | BPR4FS-15 | |
| ARF6 | BR5FS | |
| ARF62 | BPR4FS | |
| ARF626 | BPR4FS-15 | |
| ARF8 | BR5FS | |
| ARF86 | BR5FS | |
| ASF32 | BPR6FS | |
| ASF32C | BPR6FS | |
| ASF32M | BPR6FS | |
| ASF32P | UR5IX | |
| ASF42 | BPR5FS-11 | |
| ASF426C | BPR5FS-15 | |
| ASF42C | BPR5FS-11 | |
| ASF42P | UR4IX | |
| ASF44P | UR4IX | |
| ASF52 | BPR4FS | |
| ASF526 | BPR4FS-15 | |
| AV22CU | BP6HS | V-Line No. 18 |
| AV4 | B5HS | |
| AV42 | BP5HS | |
| AV52 | BP5HS | |
| AWRF32 | BPR6EFS | V-Line No. 7 |
| AWRF325 | BPR6EFS-13 | |
| AWRF42 | BPR5EFS | |
| AWSF22C | BPR6EFS | V-Line No. 7 |
| AWSF22F | PTR6D-13 | |
| AWSF22FM | TR5IX | |
| AWSF22FM1 | TR5IX | |
| AWSF22FS | PTR6D-13G | |
| AWSF24C | TR5-1 | |
| AWSF32 | BPR6EFS | V-Line No. 7 |
| AWSF32C | BPR6EFS | V-Line No. 7 |
| AWSF32E | TR55IX | |
| AWSF32EE | TR55IX | |
| AWSF32F | PTR5D-10 | V-Line No. 31 |
| AWSF32FM | TR5IX | |
| AWSF32P | BPR5EFVX | |
| AWSF32PM | BPR5EFVX | |
| AWSF32PP | TR5IX | |
| AWSF34 | TR5-1 | |
| AWSF34C | TR5-1 | |
| AWSF34PP | TR5-1IX | |
| AWSF42 | BPR5EFS | |
| AWSF42C | BPR5EFS | |
| AWSF42EE | TR55IX | |
| AWSF42PP | TR55IX | |
| AWSF44C | TR5-1 | |

| MOTORCRAFT | → NGK Typ | V-LINE |
|-------------------|------------------|---------------|
| AWSF52C | BPR5EFS | |
| AWSF54 | TR5-1 | |
| AWSF54C | TR5-1 | |
| AWSFA32C | BPR5EFS | |
| AYFS 22 PP 1 | PTR5A-13 | V-Line No. 25 |
| AYFS22C | PTR5A-13 | V-Line No. 25 |
| AYFS22FE1J | PLTR6A-10G | |
| AYFS22FPM1 | PTR5A-13 | V-Line No. 25 |
| AYFS22PP | PTR5A-13 | V-Line No. 25 |
| AYFS22PP1 | PTR5A-13 | V-Line No. 25 |
| AYRF22P | PTR5A-13 | V-Line No. 25 |
| AYRF22PP | PTR5A-13 | V-Line No. 25 |
| AYSF32YPC | ILTR5A-13G | |
| AZFS22C | PTR5A-13 | V-Line No. 25 |
| AZFS22PP | PTR5A-13 | V-Line No. 25 |
| AZFS32FE | PTR5A-13 | V-Line No. 25 |
| BF1 | A7FS | |
| BF12 | AP8FS | |
| BF22 | AP6FS | |
| BF22C | AP6FS | |
| BF22CU | AP6FS | |
| BF22CX | AP6FS | |
| BF22X | AP6FS | |
| BF3 | A6FS | |
| BF32 | AP6FS | |
| BF32CU | AP6FS | |
| BF32CX | AP6FS | |
| BF32X | AP6FS | |
| BF42 | AP5FS | |
| BF42CU | AP5FS | |
| BF601 | A9FS | |
| BF82 | AP5FS | |
| BF901 | A8FS | |
| BF92 | AP5FS | |
| BFS22C | APR6FS | |
| BFS32C | APR6FS | |
| BFS32C1 | APR6FS | |
| BRF22 | APR6FS | |
| BRF22C | APR6FS | |
| BRF31 | AR6FS | |
| BRF314 | AR6FS | |
| BRF32 | APR6FS | |
| BRF3M | AR6FS | |
| BRF42 | APR5FS | |
| BRF82 | APR5FS | |
| BSF31 | AR6FS | |
| BSF314 | AR6FS | |
| BSF82 | APR5FS | |
| BSF92 | APR5FS | |
| BTF1 | A7FS | |
| BTF3 | A6FS | |
| BTF31 | A6FS | |



| MOTORCRAFT | → NGK Typ | V-LINE |
|----------------------------------|------------------|---------------|
| BTF42 | AP5FS | |
| BTF6 | A6FS | |
| BTRF42 | APR5FS | |
| HJFS24FP | PZJAR6A11H | |
| NHSP LD => siehe TORCH | | |
| NISSAN | → NGK Typ | V-LINE |
| 22401-01B14 | BPR5ES-11 | |
| 22401-01M14 | BP4ES-L-11 | |
| 22401-01P14 | BCPR4ES-11 | |
| 22401-01P15 | BCPR5ES-11 | |
| 22401-01P16 | BCPR6ES-11 | V-Line No. 11 |
| 22401-01P17 | BCPR7ES-11 | |
| 22401-01P75 | BCPR5ES-11 | |
| 22401-01P76 | BCPR6ES-11 | V-Line No. 11 |
| 22401-01P90 | BCPR5ES-11 | |
| 22401-01P91 | BCPR6ES-11 | V-Line No. 11 |
| 22401-02P15 | BCPR5E-11 | |
| 22401-02P16 | BCPR6E-11 | V-Line No. 11 |
| 22401-02P17 | BCPR7E-11 | |
| 22401-08U15 | PFR5K-11 | |
| 22401-08U75 | PFR5K-11 | |
| 22401-0P615 | PFR5F-11A | |
| 22401-0P616 | PFR6F-11A | |
| 22401-0P675 | PFR5F-11A | |
| 22401-0P676 | PFR6F-11A | |
| 22401-10F14 | BCPR4ES-11 | |
| 22401-10F15 | BCP5ES | V-Line No. 16 |
| 22401-10F16 | BCP6ES | V-Line No. 17 |
| 22401-10F17 | BCP7ES | |
| 22401-10P15 | BCPR5E-11 | |
| 22401-10P16 | BKR6E-11 | V-Line No. 14 |
| 22401-10P17 | BCPR7E-11 | |
| 22401-11200 | BC6ES | |
| 22401-12E14 | BCPR4ES-11 | |
| 22401-12E15 | BCPR5ES | |
| 22401-12E16 | BCPR6ES | V-Line No. 12 |
| 22401-12E17 | BCPR7ES | |
| 22401-12E76 | BCPR6ES | V-Line No. 12 |
| 22401-18V15 | PGR5A | |
| 22401-18V16 | PGR6A | |
| 22401-18V17 | PGR7A | |
| 22401-19V15 | BCP5ES | V-Line No. 16 |
| 22401-19V16 | BCP6ES | V-Line No. 17 |
| 22401-19V17 | BCP7ES | |
| 22401-19V65 | BCPR5ES | |
| 22401-19V66 | BCPR6ES | V-Line No. 12 |
| 22401-1A50A | ILFR5B11 | |
| 22401-1F720 | BKR5E-11 | V-Line No. 33 |
| 22401-1LA1C | DILKAR7B11 | |
| 22401-1LA7C | DILKAR7B11 | |

| NISSAN | → NGK Typ | V-LINE |
|----------------|------------------|---------------|
| 22401-1N506 | BKR6E-N | |
| 22401-1N516 | BKR6E-N | |
| 22401-1N567 | PFR7G-11 | |
| 22401-1P114 | PFR4G-11 | |
| 22401-1P115 | PFR5G-11 | |
| 22401-1P116 | PFR6G-11 | |
| 22401-1P117 | PFR7G-11 | |
| 22401-1P175 | PFR5G-11 | |
| 22401-1P175-Q0 | PFR5G-11 | |
| 22401-1P175-VA | PFR5G-11 | |
| 22401-1P176 | PFR6G-11 | |
| 22401-1P176-VA | PFR6G-11 | |
| 22401-1P176-WS | PFR6G-11 | |
| 22401-1W615 | FR5AP-10 | |
| 22401-1W616 | FR6AP10 | |
| 22401-1W675 | FR5AP-10 | |
| 22401-20J04 | BKR4E | |
| 22401-20J05 | BKR5E | V-Line No. 35 |
| 22401-20J05-Q0 | BKR5E | V-Line No. 35 |
| 22401-20J05-SN | BKR5E | V-Line No. 35 |
| 22401-20J05-VA | BKR5E | V-Line No. 35 |
| 22401-20J05-W0 | BKR5E | V-Line No. 35 |
| 22401-20J06 | BKR6E | V-Line No. 28 |
| 22401-20J07 | BKR7E | |
| 22401-20J16 | BKR6E | V-Line No. 28 |
| 22401-21B15 | BPR5E | V-Line No. 6 |
| 22401-21B16 | BPR6E | V-Line No. 2 |
| 22401-21B17 | BPR7E | V-Line No. 19 |
| 22401-27N15 | PFR5B-11 | |
| 22401-27N15-VA | PFR5B-11 | |
| 22401-27N15-VB | PFR5B-11 | |
| 22401-27N16 | PFR6B-11 | |
| 22401-27N64 | PFR4B-11 | |
| 22401-27N65 | PFR5B-11 | |
| 22401-27N66 | PFR6B-11 | |
| 22401-27N67 | PFR7B-11 | |
| 22401-27T15 | PGR5A-11 | |
| 22401-27T65 | PGR5A-11 | |
| 22401-27T66 | PGR6A-11 | |
| 22401-2H015 | PLFR5A-11D | |
| 22401-2J200 | BKR5EY-11 | |
| 22401-2J200-Q0 | BKR5EY-11 | |
| 22401-2J200-VA | BKR5EY-11 | |
| 22401-2J206 | BKR6EY-11 | |
| 22401-2J206-VA | BKR6EY-11 | |
| 22401-30R14 | ZFR4E-11 | |
| 22401-30R15 | ZFR5E-11 | |
| 22401-30R16 | ZFR6E-11 | |
| 22401-30R75 | ZFR5E-11 | |
| 22401-30R75-W1 | ZFR5E-11 | |
| 22401-37P15 | PFR5B-11C | |
| 22401-37P16 | PFR6B-11C | |



| NISSAN | → NGK Typ | V-LINE |
|----------------|------------------|---------------|
| 22401-37P76 | PFR6B-11C | |
| 22401-40F15 | ZFR5D-11 | |
| 22401-40P15 | PFR5B-11B | |
| 22401-40P65 | PFR5B-11B | |
| 22401-40P66 | PFR6B-11B | |
| 22401-40V05 | BCP5E | V-Line No. 16 |
| 22401-40V06 | BCP6E | |
| 22401-40V07 | BCPR7E | |
| 22401-50Y04 | BKR4E-11 | |
| 22401-50Y05 | BKR5E-11 | V-Line No. 33 |
| 22401-50Y05-Q0 | BKR5E-11 | V-Line No. 33 |
| 22401-50Y05-VA | BKR5E-11 | V-Line No. 33 |
| 22401-50Y05-W0 | BKR5E-11 | V-Line No. 33 |
| 22401-50Y06 | BKR6E-11 | V-Line No. 14 |
| 22401-50Y07 | BKR7E-11 | |
| 22401-50Y75 | BKR5E-11 | V-Line No. 33 |
| 22401-50Y75-W0 | BKR5E-11 | V-Line No. 33 |
| 22401-53J04 | BKR4EY | |
| 22401-53J05 | BKR5EY | |
| 22401-53J05-VA | BKR5EY | |
| 22401-53J06 | BKR6EY | |
| 22401-53J06-RB | BKR6EY | |
| 22401-53J06-VA | BKR6EY | |
| 22401-53J07 | BKR7EY | |
| 22401-53J15 | PFR5B | |
| 22401-53J65 | PFR5B-9 | |
| 22401-53J66 | PFR6B-9 | |
| 22401-53J67 | PFR7B-9 | |
| 22401-53V15 | PFR5B | |
| 22401-53V16 | PFR6B | |
| 22401-53V17 | PFR7B | |
| 22401-54C68 | PFR8B-9 | |
| 22401-55V17 | PFR7B-D | |
| 22401-58S15 | PFR5A-11 | |
| 22401-58S16 | PFR6A-11 | |
| 22401-58S17 | PFR7A-11 | |
| 22401-59S16 | PFR6A-11 | |
| 22401-5M015 | PLFR5A-11 | |
| 22401-5M016 | PLFR6A-11 | |
| 22401-5M075 | PLFR5A-11 | |
| 22401-5M075-Q0 | PLFR5A-11 | |
| 22401-5M075-SN | PLFR5A-11 | |
| 22401-5M075-VA | PLFR5A-11 | |
| 22401-5M075-W0 | PLFR5A-11 | |
| 22401-60V06 | BCPR6ES-11 | V-Line No. 11 |
| 22401-6N215 | LZFR5AQP | |
| 22401-85E15 | BKR5ES-11 | V-Line No. 33 |
| 22401-85E16 | BKR6ES-11 | V-Line No. 14 |
| 22401-85E17 | BKR7ES-11 | |
| 22401-85E75 | BKR5ES-11 | V-Line No. 33 |
| 22401-85E76 | BKR6ES-11 | V-Line No. 14 |
| 22401-88G75 | BKR5EY | |

| NISSAN | → NGK Typ | V-LINE |
|----------------|------------------|---------------|
| 22401-88G75-WS | BKR5EY | |
| 22401-88G76 | BKR6EY | |
| 22401-88G76-WS | BKR6EY | |
| 22401-8H314 | LFR4AP-11 | |
| 22401-8H315 | LFR5AP-11 | |
| 22401-8H375 | LFR5AP-11 | |
| 22401-8H375-VA | LFR5AP-11 | |
| 22401-8H616 | PLFR6A-9 | |
| 22401-8H676 | PLFR6A-9 | |
| 22401-97E15 | PFR5C-11 | |
| 22401-97E65 | PFR5C-11 | |
| 22401-98E06 | BKR6ES-11 | V-Line No. 14 |
| 22401-9E075 | FR5AP-10 | |
| 22401-AG215 | PFR5P-11 | |
| 22401-AG275 | PFR5P-11 | |
| 22401-AG315 | BKR5EQUPA | |
| 22401-AH415 | FR5BP11 | |
| 22401-AH475 | FR5BP11 | |
| 22401-AJ415 | FR5AP-11 | |
| 22401-AL615 | LFR5AQP | |
| 22401-AL875 | LFR5BP-11 | |
| 22401-AR015 | LFR5AQP | |
| 22401-AR716 | LFR6A | |
| 22401-BC01B | LFR5E-11 | |
| 22401-CK81B | PLZKAR6A-11 | |
| 22401-CK87B | PLZKAR6A-11 | |
| 22401-CK87B-VA | PLZKAR6A-11 | |
| 22401-EA015 | PLZKAR6A-11 | |
| 22401-ED51A | LZKAR5AP11 | |
| 22401-ED51C | LZKAR7AP11 | |
| 22401-ED814 | LZKAR5AP11 | |
| 22401-ED815 | LZKAR6AP-11 | |
| 22401-ED816 | LZKAR7AP11 | |
| 22401-ED875 | LZKAR6AP-11 | |
| 22401-ED875-Q0 | LZKAR6AP-11 | |
| 22401-ED875-SN | LZKAR6AP-11 | |
| 22401-ED875-VA | LZKAR6AP-11 | |
| 22401-EW61B | DILKAR6A11 | |
| 22401-EW67B | DILKAR6A11 | |
| 22401-F6516 | PFR6A-11A | |
| 22401-HC000 | BPR5ES-13 | |
| 22401-HC001 | BPR6ES-13 | |
| 22401-KA460 | BKR6ETP | |
| 22401-M7915 | BR5ES | |
| 22401-M7916 | BR6ES | |
| 22401-N8715 | BP5ES-11 | |
| 22401-N8716 | BP6ES-11 | |
| 22401-N8717 | BP7ES-11 | |
| 22401-N8785 | BP5ES-11 | |
| 22401-N8786 | BP6ES-11 | |
| 22401-N8789 | BP6ES-11 | |
| 22401-N8790 | BP5ES-11 | |



| NISSAN | → NGK Typ | V-LINE |
|----------------|------------------|---------------|
| 22401-N8791 | BP6ES-11 | |
| 22401-P8314 | BPR4ES-11 | |
| 22401-P8315 | BPR5ES-11 | |
| 22401-P8316 | BPR6ES-11 | V-Line No. 13 |
| 22401-P8317 | BPR7ES-11 | |
| 22401-P8385-PC | BPR5ES-11 | |
| 22401-P8386-PC | BPR6ES-11 | V-Line No. 13 |
| 22401-P8389 | BPR4ES-11 | |
| 22401-P8390 | BPR5ES-11 | |
| 22401-P8391 | BPR6ES-11 | V-Line No. 13 |
| 22401-P8616 | BR6ES-11 | |
| 22401-P8816 | B6ES-11 | |
| 22401-P8817 | B7ES-11 | |
| 22401-S6015 | BP5ES-13 | |
| 22401-S6016 | BP6ES-13 | |
| 22401-V0515 | BP5ES | V-Line No. 8 |
| 22401-V0516 | BP6ES | V-Line No. 4 |
| 22401-V1414 | BPR4ES | |
| 22401-V1414-WL | BPR4ES | |
| 22401-V1415 | BPR5ES | V-Line No. 6 |
| 22401-V1416 | BPR6ES | V-Line No. 2 |
| 22401-V1417 | BPR7ES | V-Line No. 19 |
| 22401-V1484-PC | BPR4ES | |
| 22401-V1485-PC | BPR5ES | V-Line No. 6 |
| 22401-V1486-PC | BPR6ES | V-Line No. 2 |
| 22401-V1490 | BPR5ES | V-Line No. 6 |
| 22401-V1491 | BPR6ES | V-Line No. 2 |
| 22401-V5014 | BCPR4ES-11 | |
| 22401-V5015 | BCP5ES-11 | |
| 22401-V5016 | BCP6ES-11 | |
| 22401-V5017 | BKR7E-11 | |
| 22401-V5085 | BCP5ES-11 | |
| 22401-V5086 | BCP6ES-11 | |
| 22401-VB000 | BPR5E-11 | |
| 22401-VB006 | BPR6E-11 | |
| 22401-VR306 | IGR6B-10D | |
| 22401-W8915 | BP5ES | V-Line No. 8 |
| 22401-W8915-SA | BP5ES | V-Line No. 8 |
| 22401-W8916 | BP6ES | V-Line No. 4 |
| 22401-W8917 | BP7ES | |
| 22401-W8985 | BP5ES | V-Line No. 8 |
| 22401-W8985-PC | BP5ES | V-Line No. 8 |
| 22401-W8986 | BP6ES | V-Line No. 4 |
| 22401-W8986-PC | BP6ES | V-Line No. 4 |
| 22401-W8990 | BP5ES | V-Line No. 8 |
| 22401-W8991 | BP6ES | V-Line No. 4 |
| 22401-W9815 | BPR5ES | V-Line No. 6 |
| 22401-W9816 | BPR6ES | V-Line No. 2 |
| 22401-W9817 | BPR7ES | V-Line No. 19 |
| 22401-WA016 | PFR6G-9 | |
| 22401-WA066 | PFR6G-9 | |
| 22401-WA067 | PFR7G-9 | |

| NISSAN | → NGK Typ | V-LINE |
|---------------|------------------|---------------|
| 22401-WD517 | FR7AI-D | |
| 22401-Y9015 | BCPR5ET | |
| 22401-Y9016 | BCPR6ET | |
| 22401-Y9017 | BCPR7ET | |
| 22401-Y9065 | BCPR5ET | |
| 22401-Y9066 | BCP6ET | |
| 22401-Y9067 | BCP7ET | |
| 22401-Y9215 | BPR5ES | V-Line No. 6 |
| 22401-Y9265 | BP5ES | V-Line No. 8 |
| 22401-Y9266 | BP6ES | V-Line No. 4 |
| 22401-ZE01B | DILFR5A11 | |
| 22401-ZH015 | PLFR5A-11D | |
| B2401-89900 | BPR5EIX | |
| B2401-89904 | BP5EY | |
| B2401-89905 | BP6EY | |
| B2401-89906 | BCPR5EIX-11 | |
| B2401-89907 | BCPR6EVX-11 | |
| B2401-89908 | BPR5EY | V-Line No. 9 |
| B2401-89909 | BPR6EY | |
| B2401-M7915 | BR5ES | |
| B2401-V1415 | BPR5ES | V-Line No. 6 |
| B2401-V1416 | BPR6ES | V-Line No. 2 |
| B2401-W8915 | BP5ES | V-Line No. 8 |
| B2401-W8916 | BP6ES | V-Line No. 4 |
| B2401-W8917 | BP7ES | |
| BY480-BKR5E | BKR5EIX | |
| BY480-BKR6E | BKR6EIX | |
| BY480-BPR5E | BPR5EIX | |
| BY480-BPR6E | BPR6EIX | |
| BY480-BPR7E | BPR7EIX | |
| BY480-DCPR7 | DCPR7EIX | |
| BY481-BCPR5 | BCPR5EIX-11 | |
| BY481-BCPR6 | BCPR6EIX-11 | |
| BY481-BKR5E | BKR5EIX-11 | |
| BY481-BKR6E | BKR6EIX-11 | |
| BY481-BKR7E | BKR7EIX-11 | |
| BY481-BPR5E | BPR5EIX-11 | |
| BY481-BPR6E | BPR6EIX-11 | |
| BY481-LFR5A | LFR5AIX-11 | |
| BY481-LFR6A | LFR6AIX-11 | |
| BY481-ZFR5F | ZFR5FIX-11 | |
| BY481-ZFR6F | ZFR6FIX-11 | |
| BY482-BKR6E | LPG1 | |
| BY482-BPR6E | LPG2 | |
| BY483-BCPR5 | BCPR5EIX-11P | |
| BY483-BCPR6 | BCPR6EIX-11P | |
| BY483-BKR5E | BKR5EIX-11P | |
| BY483-HB6AI | HB6AIX-11P | |
| BY483-HB6BI | HB6BIX-11P | |
| BY484-BKR5E | BKR5EIX-P | |



| OPEL | → NGK Typ | V-LINE |
|--------------------------------|------------------|---------------|
| 09 195 109 | BKR5EK | V-Line No. 23 |
| 09 195 868 | BKR5EQUPA | |
| 09 199 038 | LTR6B-10T | |
| 12 563 707 | PZTR5A-15 | |
| 12 620 540 | ILTR5D | |
| 12 787 099 | PFR6T-10G | |
| 12 788 884 | PLFR6C-10G | |
| 1214000 | BKR5EK | V-Line No. 23 |
| 1214011 | BKR5EQUPA | |
| 1214013 | LTR6B-10T | |
| 1214014 | PZTR5A-15 | |
| 1214030 | PFR6T-10G | |
| 1214046 | PFR6T-G | |
| 1214060 | PFR6D10G | |
| 1214149 | BKR5EK | V-Line No. 23 |
| 1214527 | PLFR6C-10G | |
| 1214528 | ZFR6BP-G | |
| 25 324 618 | LTR6B-10T | |
| 55 562 534 | PFR6T-G | |
| 55 564 763 | ZFR6BP-G | |
| 55 571 391 | PFR6D10G | |
| 90 239 568 | BPR6ES | V-Line No. 2 |
| 90 239 569 | BPR6HS | V-Line No. 3 |
| 90 336 461 | BKR6ES | V-Line No. 28 |
| 90 338 179 | BCPR6ET | |
| 90 355 136 | BPR6ES | V-Line No. 2 |
| 90 356 323 | BPR5ES | V-Line No. 6 |
| 90 357 729 | BKR6EK | V-Line No. 20 |
| 90 357 780 | BKR6ES | V-Line No. 28 |
| 90 423 215 | BKR6ES | V-Line No. 28 |
| 90 512 989 | BKR5EK | V-Line No. 23 |
| PEUGEOT => siehe PSA | | |
| PONTIAC => siehe GM | | |
| PORSCHE | → NGK Typ | V-LINE |
| 999 170 223 90 | BKR7EQUP | |
| PSA | → NGK Typ | V-LINE |
| 1173702700 | BPR5HS | |
| 5960 92 | PLZKBR7A-G | |
| 5960 93 | PLZKBR7A-G | |
| 5960 E1 | PLZKBR7A-G | |
| 5960 G4 | PLZKBR7A-G | |
| 5960 H9 | PLZKBR7A-G | |
| 5960 L5 | ILZKBR7A-8G | |
| 5962 00 | BCP6ES | V-Line No. 17 |
| 5962 05 | BP6EFS | V-Line No. 5 |
| 5962 09 | BP6EFS | V-Line No. 5 |
| 5962 13 | BP6ES | V-Line No. 4 |
| 5962 14 | BP6EFS | V-Line No. 5 |

| PSA | → NGK Typ | V-LINE |
|------------|------------------|---------------|
| 5962 15 | BP6EFS | V-Line No. 5 |
| 5962 16 | BP6ES | V-Line No. 4 |
| 5962 21 | BP6ET | V-Line No. 1 |
| 5962 22 | BPR6EVX | |
| 5962 2A | BPR6ES | V-Line No. 2 |
| 5962 2T | BKR6EKC | V-Line No. 26 |
| 5962 2X | BKR6ES | V-Line No. 28 |
| 5962 71 | BKR6ES | V-Line No. 28 |
| 5962 72 | BP6EFS | V-Line No. 5 |
| 5962 7W | LFR6B | |
| 5962 80 | BP6HS | V-Line No. 18 |
| 5962 82 | BP6ES | V-Line No. 4 |
| 5962 87 | BP6EFS | V-Line No. 5 |
| 5962 88 | BP8ES | |
| 5962 90 | BP6HS | V-Line No. 18 |
| 5962 94 | BP7ES | |
| 5962 98 | BP7ES | |
| 5962 A1 | BP7ES | |
| 5962 A2 | BP6ES | V-Line No. 4 |
| 5962 A3 | BP6HS | V-Line No. 18 |
| 5962 A0 | BP7ES | |
| 5962 C5 | BKR6ES | V-Line No. 28 |
| 5962 C6 | BKR6ES | V-Line No. 28 |
| 5962 C0 | BP5EFS | |
| 5962 F7 | BCP6ES | V-Line No. 17 |
| 5962 F8 | BCP6ES | V-Line No. 17 |
| 5962 G8 | BP7ES | |
| 5962 H2 | BKR6ES | V-Line No. 28 |
| 5962 H8 | BKR5ES | V-Line No. 35 |
| 5962 H9 | BKR5ES | V-Line No. 35 |
| 5962 IA | BP5ET | |
| 5962 IK | BKR6EK | V-Line No. 20 |
| 5962 IL | BKR5EK | V-Line No. 23 |
| 5962 J9 | BKR6ES | V-Line No. 28 |
| 5962 J0 | BCP6ES | V-Line No. 17 |
| 5962 K1 | BCPR7ES | |
| 5962 K3 | BCP7ET | |
| 5962 K4 | BKR6ES | V-Line No. 28 |
| 5962 K6 | BKR6ES | V-Line No. 28 |
| 5962 K7 | BCPR6ET | |
| 5962 K0 | BCPR7ES | |
| 5962 OE | BKR6EK | V-Line No. 20 |
| 5962 R5 | BCPR6ET | |
| 5962 R9 | BKR6ES | V-Line No. 28 |
| 5962 S2 | BKR6ES | V-Line No. 28 |
| 5962 S4 | BKR5ES | V-Line No. 35 |
| 5962 S7 | BP5ES | V-Line No. 8 |
| 5962 T8 | BKR6ES | V-Line No. 28 |
| 5962 T0 | BKR6ES | V-Line No. 28 |
| 5962 V6 | BKR5ES | V-Line No. 35 |
| 5962 V7 | BKR6ES | V-Line No. 28 |
| 5962 V8 | BCPR7ES | |



| PSA | → NGK Typ | V-LINE |
|-----------------|------------------|---------------|
| 5962 W1 | BKR5ES | V-Line No. 35 |
| 5962 W4 | BCPR6ET | |
| 5962 W6 | BCPR7ES | |
| 5962 W7 | BCPR7ES | |
| 5962 W9 | BKR5EK | V-Line No. 23 |
| 5962 X5 | BCP6ES | V-Line No. 17 |
| 5962 X8 | BCP6ES | V-Line No. 17 |
| 5962 Y2 | BKR5EK | V-Line No. 23 |
| 5962 Y8 | BKR6EK | V-Line No. 20 |
| 5962 Z1 | BKR6EK | V-Line No. 20 |
| 5962 Z6 | BKR5EK | V-Line No. 23 |
| 5962 Z0 | BKR6EK | V-Line No. 20 |
| 7567 58 | BP5HS | |
| 7567 61 | BP6HS | V-Line No. 18 |
| 95496692 | BP6HS | V-Line No. 18 |
| 95611941 | BP6EFS | V-Line No. 5 |
| 95619043 | BP6ES | V-Line No. 4 |
| 96000090 | BCP5ES | V-Line No. 16 |
| 96037952 | BCP5ES | V-Line No. 16 |
| 96039962 | BCP6ET | |
| 96064890 | BKR5ES | V-Line No. 35 |
| 96097486 | BCP7ET | |
| 96145071 | BCPR6ET | |
| 97533994 | BP7EFS | |
| MKP00073 | BP7ES | |
| V 7534226 80-03 | PLZKBR7A-G | |
| V 7570106 80 | ILZKBR7A-8G | |
| ZC9862090U | BP5ES | V-Line No. 8 |
| ZCT000011 | BP6HS | V-Line No. 18 |
| ZCT000012 | BP7ES | |
| RENAULT | → NGK Typ | V-LINE |
| 22 40 1EA 015 | PLZKAR6A-11 | |
| 74 39 146 775 | BCPR5ET | |
| 77 00 101 401 | BKR5ES | V-Line No. 35 |
| 77 00 103 502 | BPR5ES | V-Line No. 6 |
| 77 00 103 503 | BPR5ES | V-Line No. 6 |
| 77 00 103 533 | BKR5EK | V-Line No. 23 |
| 77 00 107 916 | BKR5EK | V-Line No. 23 |
| 77 00 260 637 | BCP7ET | |
| 77 00 266 295 | BPR6EFS | V-Line No. 7 |
| 77 00 267 140 | BPR6EFS | V-Line No. 7 |
| 77 00 267 805 | BP7EFVX | |
| 77 00 273 462 | BKR6ES | V-Line No. 28 |
| 77 00 273 698 | BKR6EVX | |
| 77 00 500 168 | BKR6E | V-Line No. 28 |
| 77 00 553 622 | BP6ES | V-Line No. 4 |
| 77 00 587 168 | BP6HS | V-Line No. 18 |
| 77 00 714 540 | BPR6EFS | V-Line No. 7 |
| 77 00 722 095 | BP6EFS | V-Line No. 5 |
| 77 00 724 821 | BP6ES | V-Line No. 4 |
| 77 00 725 302 | BPR5ES | V-Line No. 6 |

| RENAULT | → NGK Typ | V-LINE |
|-----------------|------------------|---------------|
| 77 00 726 503 | BP7EFS | |
| 77 00 727 383 | BPR6ES | V-Line No. 2 |
| 77 00 731 583 | BP7EFS | |
| 77 00 732 626 | BP8ES | |
| 77 00 733 422 | BP5HS | |
| 77 00 736 149 | BP7EFS | |
| 77 00 736 150 | BP7EFS | |
| 77 00 737 457 | BP7EFS | |
| 77 00 737 458 | BP6EFS | V-Line No. 5 |
| 77 00 737 459 | BP7ES | |
| 77 00 737 612 | BCP5ES | V-Line No. 16 |
| 77 00 742 094 | BPR7ES | V-Line No. 19 |
| 77 00 743 137 | BCP5ES | V-Line No. 16 |
| 77 00 743 920 | BP5ES | V-Line No. 8 |
| 77 00 749 163 | BCP5ES | V-Line No. 16 |
| 77 00 824 821 | BP6ES | V-Line No. 4 |
| 77 00 852 522 | BP6EFS | V-Line No. 5 |
| 77 00 852 543 | BP7EFVX | |
| 77 00 855 463 | BCP6ET | |
| 77 00 855 918 | BP5EFS | |
| 77 00 856 342 | BCP6ET | |
| 77 00 859 910 | BCP5ES | V-Line No. 16 |
| 77 00 859 967 | BP5ES | V-Line No. 8 |
| 77 00 860 235 | BP5ESZ | |
| 77 00 861 471 | BP7ES | |
| 77 00 861 472 | BP6ESZ | |
| 77 00 862 054 | BP5ES | V-Line No. 8 |
| 77 00 868 864 | BPR7ES | V-Line No. 19 |
| 77 00 869 200 | BK5ESZ | |
| 77 00 871 617 | BCPR6ET | |
| 77 01 021 767 | BP6EFS | V-Line No. 5 |
| 77 01 041 021 4 | BP5ES | V-Line No. 8 |
| 77 01 041 214 | BP5ES | V-Line No. 8 |
| 77 01 041 215 | BP6EFS | V-Line No. 5 |
| 77 01 042 816 | BKR6ES | V-Line No. 28 |
| 77 01 043 624 | BCPR6ET | |
| 77 01 045 018 | BP7EFS | |
| 77 01 366 057 | BP6HS | V-Line No. 18 |
| 77 01 366 086 | BP6ES | V-Line No. 4 |
| 77 01 366 087 | BP7ES | |
| 77 01 366 137 | BP6EFS | V-Line No. 5 |
| 77 01 366 267 | BP6HS | V-Line No. 18 |
| 77 01 366 268 | BP7ES | |
| 77 01 366 269 | BP6ES | V-Line No. 4 |
| 77 01 366 270 | BP6EFS | V-Line No. 5 |
| 77 01 366 513 | BP5HS | |
| 77 01 366 514 | BP6EFS | V-Line No. 5 |
| 77 01 366 515 | BP6HS | V-Line No. 18 |
| 77 01 366 516 | BP6ES | V-Line No. 4 |
| 77 01 366 539 | BP5ES | V-Line No. 8 |
| 77 01 366 903 | BP5ES | V-Line No. 8 |
| 77 01 414 022 | BP5HS | |



| RENAULT | → NGK Typ | V-LINE |
|--------------------|------------------|---------------|
| 77 01 414 025 | BP6ES | V-Line No. 4 |
| 77 01 414 026 | BP7EFS | |
| 77 01 414 027 | BP7EFS | |
| 77 01 414 031 | BPR6ES | V-Line No. 2 |
| 77 01 414 105 | BP5ESZ | |
| 82 00 020 791 | BKR6EZ | V-Line No. 38 |
| 82 00 027 363 | BKR5EK | V-Line No. 23 |
| 82 00 030 765 | LZKAR7A | |
| 82 00 239 321 | PFR6E-10 | |
| 82 00 314 928 | PFR7G-9 | |
| 82 00 322 273 | LZKAR7A | |
| 82 00 363 364 | PFR6G-9 | |
| 82 00 363 384 | PFR6G-9 | |
| 82 00 492 426 | PFR7Z-TG | |
| 82 00 587 901 | ILKAR7A7 | |
| 82 00 592 215 | LZKAR7B | |
| 83 04 504 277 | ZFR5F | |
| 89 33 003 862 | BKR6ES | V-Line No. 28 |
| 96 26 575 480 | BKR6EK | V-Line No. 20 |
| 96 32 182 880 | PFR6E-10 | |
| ROLLS ROYCE | → NGK Typ | V-LINE |
| RH12050 | BPR4EVX | |
| RH13439 | BKR4EVX | |
| RH13998 | BKR5EVX | |
| ROVER | → NGK Typ | V-LINE |
| NLP100260 | BPR6E | V-Line No. 2 |
| NLP100290 | PFR6N-11 | |
| SAAB | → NGK Typ | V-LINE |
| 12 787 099 | PFR6T-10G | |
| 12 788 884 | PLFR6C-10G | |
| 15 885 210 | BCPR7ES-11 | |
| 30 520 467 | BCPR6ES-11 | V-Line No. 11 |
| 32 000 330 | BCPR7ES-11 | |
| 45 71 808 | PFR7H-10 | |
| 55 564 215 | BKR7ESC-11 | |
| 55 564 763 | ZFR6BP-G | |
| 55 571 391 | PFR6D10G | |
| 56 92 485 | BCP7EVX | |
| 59 58 780 | BCP5EVX | |
| 59 58 798 | BCP6EVX | |
| 88 19 302 | BCP7EVX | |
| 91 12 541 | BCPR7ES-11 | |
| 91 16 385 | BCP5ES | V-Line No. 16 |
| 91 17 565 | BCPR6ES-11 | V-Line No. 11 |
| 91 36 276 | BCP5EVX | |
| 91 39 643 | BCP6EVX | |
| 91 71 307 | BKR7ES-11 | |
| 91 85 398 | PFR7H-10 | |
| 91 88 681 | PFR7H-10 | |

| SAAB | → NGK Typ | V-LINE |
|-----------------------------------|------------------|---------------|
| 91 95 109 | BKR5EK | V-Line No. 23 |
| 91 95 868 | BKR5EQUPA | |
| 93 99 866 | PFR6H-10 | |
| SEAT => siehe VW Group | | |
| SKODA => siehe VW Group | | |
| SMART => siehe MERCEDES | | |
| SUBARU | → NGK Typ | V-LINE |
| 22401 AA000 | BP5ES-11 | |
| 22401 AA010 | BP6ES-11 | |
| 22401 AA020 | BP6ES | V-Line No. 4 |
| 22401 AA030 | BP6ES | V-Line No. 4 |
| 22401 AA080 | BP6EY | |
| 22401 AA090 | BP7ES | |
| 22401 AA100 | BE527Y-11 | |
| 22401 AA110 | BE527Y-11 | |
| 22401 AA120 | BPR6ES-11 | V-Line No. 13 |
| 22401 AA130 | BPR6ES-11 | V-Line No. 13 |
| 22401 AA200 | BPR6ES | V-Line No. 2 |
| 22401 AA210 | BPR7ES | V-Line No. 19 |
| 22401 AA220 | BPR6ES | V-Line No. 2 |
| 22401 AA230 | BPR7E | V-Line No. 19 |
| 22401 AA310 | BKR6E-11 | V-Line No. 14 |
| 22401 AA320 | BKR6E-11 | V-Line No. 14 |
| 22401 AA360 | PFR7B | |
| 22401 AA370 | PFR6B-11 | |
| 22401 AA380 | BRE527Y-11 | |
| 22401 AA390 | BRE527Y-11 | |
| 22401 AA400 | PFR6B | |
| 22401 AA460 | BPR5EY-11 | |
| 22401 AA470 | BPR6EY-11 | V-Line No. 10 |
| 22401 AA480 | BPR5ES-11 | |
| 22401 AA500 | BKR6EVX-11 | |
| 22401 AA510 | BKR6EVX | |
| 22401 AA520 | PFR6G-11 | |
| 22401 AA530 | PFR6G | |
| 22401 AA531 | PFR6G | |
| 22401 AA570 | PFR5B-11 | |
| 22401 AA580 | PLFR6A-11 | |
| 22401 AA600 | PFR7G | |
| 22401 AA610 | ZFR6FIX-11 | |
| 22401 AA630 | ILFR6B | |
| 22401 AA650 | FR5AP-11 | |
| 22401 AA65A | FR5AP-11 | |
| 22401 AA670 | SILFR6A | |
| 22401 AA680 | ILFR6B | |
| 22401 AA700 | DILFR6D11 | |
| 22401 AA720 | SILFR6A11 | |
| 22401 AA730 | SIFR6A11 | |



| SUBARU | → NGK Typ | V-LINE |
|---------------|------------------|---------------|
| 22401 AA750 | SILFR6C11 | |
| 22401 AA760 | SILFR6B8 | |
| 22401 KA000 | BUR6EA-11 | |
| 22401 KA010 | BKR6E-11 | V-Line No. 14 |
| 22401 KA030 | BKR6E-11 | V-Line No. 14 |
| 22401 KA050 | BUR6EA-11 | |
| 22401 KA060 | BUR6EA-11 | |
| 22401 KA080 | BKR6E | V-Line No. 28 |
| 22401 KA090 | BCPR6E | V-Line No. 12 |
| 22401 KA100 | BCPR6E | V-Line No. 12 |
| 22401 KA130 | BPR6ES | V-Line No. 2 |
| 22401 KA140 | ZFR6G | |
| 22401 KA150 | BKR6E | V-Line No. 28 |
| 22401 KA160 | ZFR6G | |
| 22401 KA170 | ZFR5G | |
| 22401 KA180 | ZFR5G | |
| 22401 KA190 | BPR5E-11 | |
| 22401 KA200 | BKR5E-11 | V-Line No. 33 |
| 22401 KA210 | BKR5E-11 | V-Line No. 33 |
| 22401 KA240 | DCPR7E | |
| 22401 KA260 | DCPR7E | |
| 22401 KA290 | BKR4E-11 | |
| 22401 KA310 | DCPR8E | |
| 22401 KA320 | DCPR8EVX | |
| 22401 KA340 | KR8BI | |
| 22401 KA430 | BKR6EKPA | |
| 22401 KA440 | BKR5E | V-Line No. 35 |
| 22401 KA450 | LKR7AI | |
| 22401 KA460 | BKR6ETP | |
| 32054 1320 | B6EVX | |
| 32054 5700 | BR6ES | |
| 38028 0102 | BP6EY | |
| 42054 3200 | BP5ES | V-Line No. 8 |
| 42054 5502 | BP6ES | V-Line No. 4 |
| 42054 5602 | BP5EY-11 | |
| 42054 5702 | BP6ES-11 | |
| 42054 5800 | BE529Y-11 | |
| 42054 5802 | BE529Y-11 | |
| 42054 7102 | BP5EY | |
| 42054 7302 | BP5EY-11 | |
| 48028 7100 | BP4EY-11 | |
| 49001 0003 | BPR5EIX | |
| 49001 0013 | BP6EVX | |
| 49001 0033 | BPR5ES | V-Line No. 6 |
| 49001 0043 | BP5EY | |
| 49001 0053 | BP6EY | |
| 49001 0082 | BPR5EY | V-Line No. 9 |
| 49001 0092 | BPR6EY | |
| 88241 7800 | B5HS | |
| SAB330DE0710 | BKR5EIX-11P | |
| SAB330DE2640 | LFR6AIX-11 | |
| SAB330DE3360 | BKR5EIX-11 | |

| SUBARU | → NGK Typ | V-LINE |
|-----------------|------------------|---------------|
| SAB330DE3370 | BKR6EIX-11 | |
| SAB330DE3430 | DCPR7EIX | |
| SAB330DE3710 | BKR5EIX-11P | |
| SAB330DE5140 | LFR6AIX-11 | |
| SAB330DE8640 | IFR5E11 | |
| SAB330DE8680 | BKR5EIX-11 | |
| SAB330DE8690 | BKR6EIX-11 | |
| SAB330DE8720 | DCPR7EIX | |
| SUZUKI | → NGK Typ | V-LINE |
| 09482-00059 | BP6HS | V-Line No. 18 |
| 09482-00060 | BP7HS | |
| 09482-00074 | BP6HS | V-Line No. 18 |
| 09482-00079 | BR6ES | |
| 09482-00084 | BP6HS | V-Line No. 18 |
| 09482-00105 | BP7HS | |
| 09482-00111 | AU10EFP | |
| 09482-00118 | BP6ES | V-Line No. 4 |
| 09482-00120 | BP5HS | |
| 09482-00123 | BP5EY | |
| 09482-00124 | BP5HS | |
| 09482-00129 | BP4EY | |
| 09482-00130 | BP4EY | |
| 09482-00131 | BP5ES | V-Line No. 8 |
| 09482-00139 | BP7ES | |
| 09482-00141 | BPR6HS | |
| 09482-00147 | BPR5HS | |
| 09482-00155 | BPR5ES | V-Line No. 6 |
| 09482-00159 | BPR4EY | |
| 09482-00167 | BPR5EY | V-Line No. 9 |
| 09482-00167-000 | BPR5EY | V-Line No. 9 |
| 09482-00167-001 | BPR5ES | V-Line No. 6 |
| 09482-00175 | BP8ES | |
| 09482-00177 | BP6ES | V-Line No. 4 |
| 09482-00188 | BP6HS | V-Line No. 18 |
| 09482-00189 | BP7HS | |
| 09482-00208 | B8EGV | |
| 09482-00209 | B9EGV | |
| 09482-00210 | B10EGV | |
| 09482-00216 | BP4EY-11 | |
| 09482-00217 | BP5EY-11 | |
| 09482-00218 | BP4EY-11 | |
| 09482-00219 | BP5EY-11 | |
| 09482-00226 | BP7ES | |
| 09482-00228 | BP5HS | |
| 09482-00229 | BPR6HS | |
| 09482-00259 | BP6HS | V-Line No. 18 |
| 09482-00281 | BPR6HS | |
| 09482-00282 | B5HS | |
| 09482-00284 | BP6EY-11 | |
| 09482-00285 | BPR6ES-11 | V-Line No. 13 |
| 09482-00286 | BPR6EY-11 | V-Line No. 10 |



| SUZUKI | → NGK Typ | V-LINE |
|-----------------|------------------|---------------|
| 09482-00287 | BP5ES-11 | |
| 09482-00299 | BPR6ES | V-Line No. 2 |
| 09482-00302-111 | BPR6HS | |
| 09482-00303 | BP6EY-11 | |
| 09482-00305 | BP5HS | |
| 09482-00306 | BPR6HS | |
| 09482-00309 | B5HS | |
| 09482-00310 | C7HA | |
| 09482-00312 | BPR5EY-11 | |
| 09482-00316 | BPR5HS | |
| 09482-00322 | BPR5EIX | |
| 09482-00359 | BPR5HS | |
| 09482-00362 | ZGR5A | V-Line No. 15 |
| 09482-00363 | BPR5EY | V-Line No. 9 |
| 09482-00368 | DCP7E | |
| 09482-00369 | DCP7E | |
| 09482-00378 | DCPR8E | |
| 09482-00379 | DCP8E | |
| 09482-00381 | PJR7A | |
| 09482-00383 | DCPR8EVX | |
| 09482-00384 | DCPR8EVX | |
| 09482-00385 | BP7ES | |
| 09482-00386 | DCP7EVX | |
| 09482-00387 | DCP7EVX | |
| 09482-00392 | BP6ES | V-Line No. 4 |
| 09482-00395 | ZG5E | |
| 09482-00409 | BPR6ES | V-Line No. 2 |
| 09482-00416-111 | BPR5HS | |
| 09482-00419 | R2525-11 | |
| 09482-00421 | BPR6ES-11 | V-Line No. 13 |
| 09482-00422 | R5184-95 | |
| 09482-00423 | R5184-10 | |
| 09482-00424 | R5184-105 | |
| 09482-00426 | BK6E | |
| 09482-00427 | BKR6E | V-Line No. 28 |
| 09482-00429 | BKR6E | V-Line No. 28 |
| 09482-00430 | R0373A-10 | |
| 09482-00431 | R0373A-11 | |
| 09482-00432 | BPR5E | V-Line No. 6 |
| 09482-00433 | BPR5EY-11 | |
| 09482-00434 | BP7ES | |
| 09482-00446 | DCPR6E | |
| 09482-00447 | DCPR6E | |
| 09482-00448 | DCPR7E | |
| 09482-00449 | DCPR7E | |
| 09482-00450 | DCPR8E | |
| 09482-00452 | ZGR5A | V-Line No. 15 |
| 09482-00468 | BPR5E | V-Line No. 6 |
| 09482-00476 | BKR5E | V-Line No. 35 |
| 09482-00477 | BKR5E | V-Line No. 35 |
| 09482-00479 | DCPR7EVX | |
| 09482-00481 | DCPR8EVX | |

| SUZUKI | → NGK Typ | V-LINE |
|-----------------|------------------|---------------|
| 09482-00482 | DCPR7EVX | |
| 09482-00484 | DCPR8EVX | |
| 09482-00487 | BPR6ES | V-Line No. 2 |
| 09482-00488 | DCPR7E | |
| 09482-00493 | BPR5E-11 | |
| 09482-00494 | BKR6E-11 | V-Line No. 14 |
| 09482-00495 | BPR7ES | V-Line No. 19 |
| 09482-00496 | BPR5E-11 | |
| 09482-00497 | BKR5E-11 | V-Line No. 33 |
| 09482-00498 | BPR7ES | V-Line No. 19 |
| 09482-00499 | R4118S-8 | |
| 09482-00500 | R4118S-9 | |
| 09482-00501 | BPR6EY | |
| 09482-00502 | BP5EY | |
| 09482-00504 | BPR5EY | V-Line No. 9 |
| 09482-00508 | BKR6E-11 | V-Line No. 14 |
| 09482-00509 | R6918B-8 | |
| 09482-00511 | R6918B-7 | |
| 09482-00513 | R0045J-10 | |
| 09482-00514 | R0045J-11 | |
| 09482-00521 | PGR5A | |
| 09482-00525 | IKR7A | |
| 09482-00527 | KR7AI | |
| 09482-00530 | BPR6HS | |
| 09482-00531 | BP6HS | V-Line No. 18 |
| 09482-00537 | DCPR9EVX | |
| 09482-00540 | PFR5G-11 | |
| 09482-00546 | GR5AI-10 | |
| 09482-00547 | IFR5E11 | |
| 09482-00548 | IFR6E11 | |
| 09482-00549 | IFR5J11 | |
| 09482-00550 | IFR6J11 | |
| 09482-00556 | CR8EIA9 | |
| 09482-00562 | IFR5E11 | |
| 09482-00566 | BKR5E-11 | V-Line No. 33 |
| 09482-00602 | IKR6G11 | |
| 09482-00603 | IKR6G11 | |
| 09482-00606 | SILFR6A11 | |
| 09482-69001 | BPR6HS | |
| 27118-50000 | R7433-8 | |
| 99000-69257-000 | R0161-10 | |
| 99000-69257-001 | R2525-10 | |
| 99000-69835-BP6 | BPR6HIX | |
| 99000-79A37-16E | BPR5EIX | |
| 99000-79A37-K0P | BKR6EVX-11 | |
| 99000-79A37-W6X | BPR5EIX | |
| 99000-79B56 | BPR4EY-11 | |
| 99000-79J80-K16 | BKR5EIX-11 | |
| 99000-79J80-K20 | BKR6EIX-11 | |
| 99000-79J80-U22 | DCPR7EIX | |
| 99000-79J80-W16 | BPR5EIX-11 | |
| 99000-79J80-W20 | BPR6EIX-11 | |



| SUZUKI | → NGK Typ | V-LINE |
|-----------------|------------------|---------------|
| 99000-79J80-W22 | BPR7EIX | |
| 99000-79K60-BP6 | BPR6EIX-11 | |
| 99000-79K60-DC7 | DCPR7EIX | |
| 99000-79K60-K5R | BKR5EIX | |
| 99000-79K60-K6R | BKR6EIX | |
| 99000-79K60-KR6 | BKR6EIX-11 | |
| 99000-79K60-P5R | BPR5EIX | |
| 99000-79K60-P6R | BPR6EIX | |
| 99000-79K60-P7R | BPR7EIX | |
| 99000-79K60-PR5 | BPR5EIX-11 | |
| 99000-79K73-K16 | BKR5EIX-11P | |
| 99000-79L65-002 | BKR5EIX-P | |
| 99000-79L65-005 | BKR5EIX-11P | |
| TORCH | → NGK Typ | V-LINE |
| 5580 | BP6ET | V-Line No. 1 |
| 8012 | BP6EVX | |
| DK7RTC | DCPR7E | |
| E5RTC | BPR5HS | |
| E5TC | BP5HS | |
| E6RTC | BPR6HS | |
| E6TC | BP6HS | V-Line No. 18 |
| E7RTC | BPR6HS | |
| E7TC | BP7HS | |
| E7TJC | BP6ET | V-Line No. 1 |
| E8TC | BP7HS | |
| F5RF | BPR5EY | V-Line No. 9 |
| F5RTC | BPR5ES | V-Line No. 6 |
| F5TC | BP5ES | V-Line No. 8 |
| F6RF | BPR6EY | |
| F6RTC | BPR6ES | V-Line No. 2 |
| F6T | BP6ES | V-Line No. 4 |
| F6TC | BP6ES | V-Line No. 4 |
| F7RTC | BPR7ES | V-Line No. 19 |
| F7RTJC | BP6ET | V-Line No. 1 |
| F7TC | BP7ES | |
| F7TJC | BP6ET | V-Line No. 1 |
| F8RTC | BP8ES | |
| F8TC | BP7ES | |
| K4RTC3 | ZFR5F | |
| K5RF11 | BKR5E-11 | V-Line No. 33 |
| K5RTC11 | BKR5ES-11 | V-Line No. 33 |
| K5RTS | ZFR5P-G | |
| K5TC | BKR5ES-11 | V-Line No. 33 |
| K6RF | BKR6ES | V-Line No. 28 |
| K6RF11 | BKR6E-11 | V-Line No. 14 |
| K6RTC | BKR5E-11 | V-Line No. 33 |
| K6RTC11 | BKR6ES-11 | V-Line No. 14 |
| K6RTJC | BKUR6ET | V-Line No. 27 |
| K6TC | BKR6ES-11 | V-Line No. 14 |
| K6TJC | BCP6ET | |
| K7RTC | BKR6ES | V-Line No. 28 |

| TORCH | → NGK Typ | V-LINE |
|----------------|------------------|---------------|
| K7TC | BCP6ES | V-Line No. 17 |
| K7TJC | BCP6ET | |
| P5RTC | BPR5FS | |
| P5TC | BP5FS | |
| P6RTC | BPR6FS | |
| P6TC | BP6FS | |
| P7RTC | BP7FS | |
| P7TC | BP7FS | |
| Q5RTC | BPR5EFS | |
| Q5TC | BP5EFS | |
| Q6RTC | BPR6EFS | V-Line No. 7 |
| Q6TC | BP6EFS | V-Line No. 5 |
| Q7TC | BP5EFS | |
| T5RTC | APR6FS | |
| T5TC | AP5FS | |
| T6RTC | APR6FS | |
| T6TC | AP6FS | |
| TOYOTA | → NGK Typ | V-LINE |
| 04195-34140 | BP5ES | V-Line No. 8 |
| 04195-34150 | BP6ES | V-Line No. 4 |
| 04195-34280 | BPR5EY | V-Line No. 9 |
| 04195-34320 | BPR5EY-11 | |
| 08922-01016-83 | BPR5EY | V-Line No. 9 |
| 08922-01017-83 | BPR6EY-11 | V-Line No. 10 |
| 08922-01019-83 | BPR5EY-11 | |
| 08922-01020-83 | BCPR6EY-11 | |
| 90048-51054 | BPR5EY | V-Line No. 9 |
| 90048-51059 | BPR6EY | |
| 90048-51063 | BPR5EY-11 | |
| 90048-51093-A | BPR5EY-11 | |
| 90048-51108-1 | BPR6EKB-L | |
| 90048-51126 | BPR5EJ | |
| 90048-51131 | BPR5EKB | |
| 90048-51131-1 | BPR5EKB | |
| 90048-51134 | BCPR6EKD | |
| 90048-51134-1 | BCPR6EKD | |
| 90048-51140 | BPR6EKB | |
| 90048-51158 | BKR5E-11 | V-Line No. 33 |
| 90048-51187 | IKR7C | |
| 90080-91116 | BKR6EKP-11 | |
| 90098-14395 | BP4EY | |
| 90098-14425 | BPR4EY | |
| 90098-14545 | BPR4ES-13 | |
| 90098-14595 | BP4EY | |
| 90098-14615 | BP4EY-11 | |
| 90098-14665 | BPR4EY-11 | |
| 90098-14785 | BPR4FS | |
| 90098-14805 | BPR4FS-15 | |
| 90098-16145 | AP5FS | |
| 90098-16325 | BPR5ES | V-Line No. 6 |
| 90098-16395 | BP5EY | |



| TOYOTA | → NGK Typ | V-LINE |
|---------------|------------------|---------------|
| 90098-16425 | BPR5EY | V-Line No. 9 |
| 90098-16515 | BP5HS | |
| 90098-16545 | BP5ES-13 | |
| 90098-16595 | BP5EY | |
| 90098-16615 | BP5EY-11 | |
| 90098-16635 | BP5EFS | |
| 90098-16655 | BUR5EB-11 | |
| 90098-16675 | BPR5EY | V-Line No. 9 |
| 90098-16695 | BP5EY | |
| 90098-16705 | BP5FS | |
| 90098-16735 | APR5FS | |
| 90098-16745 | BPR5E | V-Line No. 6 |
| 90098-16785 | BPR5FS | |
| 90098-16795 | BPR5FS-11 | |
| 90098-16805 | BPR5FS-15 | |
| 90098-16865 | BR5FS | |
| 90098-16875 | YR55IX | |
| 90098-16895 | BPR6EFS | V-Line No. 7 |
| 90098-16935 | BR5ES | |
| 90098-16955 | BE527Y-11 | |
| 90098-16975 | BUR5EB-11 | |
| 90098-16985 | BCPR5EY-11 | |
| 90098-20145 | AP6FS | |
| 90098-20325 | BPR6ES | V-Line No. 2 |
| 90098-20395 | BP6EY | |
| 90098-20425 | BPR6EY | |
| 90098-20515 | BP6HS | V-Line No. 18 |
| 90098-20545 | BPR6EVX-11 | |
| 90098-20595 | BP6EY | |
| 90098-20615 | BP6EY-11 | |
| 90098-20625 | BPR6EK-A | |
| 90098-20635 | BP6EFS | V-Line No. 5 |
| 90098-20655 | BUR6EB-11 | |
| 90098-20665 | BPR6EY-11 | V-Line No. 10 |
| 90098-20675 | BPR6EY | |
| 90098-20695 | BP6ES | V-Line No. 4 |
| 90098-20705 | BP6FS | |
| 90098-20735 | APR6FS | |
| 90098-20745 | BPR6ES | V-Line No. 2 |
| 90098-20755 | BUR6EA-11 | |
| 90098-20785 | BPR6FS | |
| 90098-20885 | BP6EFS | V-Line No. 5 |
| 90098-20895 | BPR6EFS | V-Line No. 7 |
| 90098-20905 | BR6ES | |
| 90098-20915 | BUR6EB-11 | |
| 90098-20935 | BR6ES | |
| 90098-20975 | BUR6EB-11 | |
| 90098-20985 | BCPR6EY-11 | |
| 90098-21655 | BR6EB-L-11 | |
| 90098-21915 | BR6EB-L-11 | |
| 90098-22325 | BPR7ES | V-Line No. 19 |
| 90098-22515 | BP7HS | |

| TOYOTA | → NGK Typ | V-LINE |
|---------------|------------------|---------------|
| 90098-22595 | BP7EY | |
| 90098-22655 | BUR7EB-11 | |
| 90098-22745 | BPR7ES | V-Line No. 19 |
| 90098-22755 | BUR7EA-11 | |
| 90098-22885 | BP7EFS | |
| 90098-22915 | BUR7EB-11 | |
| 90098-22975 | BUR7EB-11 | |
| 90098-24125 | BP8ES | |
| 90098-24695 | BP8ES | |
| 90098-33034 | BCPR5EY-11 | |
| 90098-64032 | BPR4EVX | |
| 90098-64033 | BPR4EVX | |
| 90098-64050 | BPR4ES-13 | |
| 90098-64065 | ZFR4F-11 | |
| 90098-64066 | ZFR4F-11 | |
| 90098-64112 | BUR4EB-11 | |
| 90098-66001 | BP5EY-11 | |
| 90098-66004 | BPR5E-11 | |
| 90098-66005 | BCPR5EY-11 | |
| 90098-66006 | BUR5EB-11 | |
| 90098-66007 | BP5EY-11 | |
| 90098-66031 | BPR5EY-11 | |
| 90098-66032 | BPR5EIX | |
| 90098-66033 | BPR5EIX | |
| 90098-66038 | BCPR5EIX-11 | |
| 90098-66039 | BCPR5EIX-11 | |
| 90098-66040 | BCPR5EY-11 | |
| 90098-66045 | BCPR5EIX-11 | |
| 90098-66047 | BKR5E-11 | V-Line No. 33 |
| 90098-66050 | BPR5ES-13 | |
| 90098-66053 | BKR5E | V-Line No. 35 |
| 90098-66054 | BKR5EVX-11 | |
| 90098-66056 | BKR5EYA-11 | V-Line No. 39 |
| 90098-66058 | BPR5E | V-Line No. 6 |
| 90098-66059 | BKR5E-N-11 | |
| 90098-66064 | PFR5J-11 | |
| 90098-66065 | ZFR5J-11 | |
| 90098-66066 | ZFR5F-11 | |
| 90098-66069 | BPR5EKB | |
| 90098-66070 | PFR5B-11 | |
| 90098-66071 | BKR5EYA | |
| 90098-66075 | ZFR5E-11 | |
| 90098-66077 | BKR5EVX-11 | |
| 90098-66080 | PZFR5F-11 | |
| 90098-66081 | PZFR5F | |
| 90098-66082 | BCPR5E | V-Line No. 32 |
| 90098-66108 | PGR5A-11 | |
| 90098-66109 | BPR5EJ | |
| 90098-66113 | PTR5C-13 | |
| 90098-66114 | BKR5EIX-11 | |
| 90098-66115 | BCPR5EIX-11 | |
| 90098-66116 | BPR5EIX-11 | |



| TOYOTA | → NGK Typ | V-LINE |
|---------------|------------------|---------------|
| 90098-70001 | BP6ES-11 | |
| 90098-70002 | BUR6EA-11 | |
| 90098-70003 | BPR6ES-11 | V-Line No. 13 |
| 90098-70004 | BPR6ES-11 | V-Line No. 13 |
| 90098-70005 | BKR6E-11 | V-Line No. 14 |
| 90098-70007 | BP6ES-11 | |
| 90098-70008 | BPR6EFS-15 | |
| 90098-70027 | AR6FS | |
| 90098-70031 | BPR6EY-11 | V-Line No. 10 |
| 90098-70032 | BP6EVX | |
| 90098-70033 | BPR6EVX | |
| 90098-70034 | BCPR6EY-11 | |
| 90098-70036 | B6EVX | |
| 90098-70038 | BCPR6EVX-11 | |
| 90098-70039 | BCPR6EVX-11 | |
| 90098-70040 | BKR6E-11 | V-Line No. 14 |
| 90098-70041 | ZF6A-11 | |
| 90098-70043 | BP6ES | V-Line No. 4 |
| 90098-70044 | ZFR6A-11 | |
| 90098-70046 | BCPR6EVX-11 | |
| 90098-70047 | BKR6E-11 | V-Line No. 14 |
| 90098-70048 | BPR6EKN | |
| 90098-70049 | BPR6EKB-L | |
| 90098-70050 | BPR6EVX-11 | |
| 90098-70051 | DCPR6E | |
| 90098-70053 | BKR6E | V-Line No. 28 |
| 90098-70054 | BKR6EVX-11 | |
| 90098-70055 | BPR6EFS-15 | |
| 90098-70056 | BKR6EYA-11 | |
| 90098-70058 | BPR6ES | V-Line No. 2 |
| 90098-70059 | BKR6E-N-11 | |
| 90098-70060 | PFR6G-11 | |
| 90098-70064 | PFR6J-11 | |
| 90098-70065 | ZFR6J-11 | |
| 90098-70066 | ZFR6F-11 | |
| 90098-70067 | BCPR6EKD | |
| 90098-70069 | BPR6EKB | |
| 90098-70070 | PFR6B-11 | |
| 90098-70071 | BKR6EYA | |
| 90098-70074 | ZFR6G | |
| 90098-70077 | BKR6EVX-11 | |
| 90098-70080 | PZFR6F-11 | |
| 90098-70081 | PZFR6F | |
| 90098-70082 | BCPR6E | V-Line No. 12 |
| 90098-70085 | BP6ET | V-Line No. 1 |
| 90098-70086 | PFR6J | |
| 90098-70105 | BPR6EKN | |
| 90098-70108 | PGR6A-11 | |
| 90098-70114 | BKR6EIX-11 | |
| 90098-70115 | BCPR6EIX-11 | |
| 90098-70116 | BPR6EIX-11 | |
| 90098-72019 | DPR7Z | |

| TOYOTA | → NGK Typ | V-LINE |
|---------------|------------------|---------------|
| 90098-72042 | DCP7E | |
| 90098-72047 | BKR7E-11 | |
| 90098-72051 | DCPR7E | |
| 90098-72052 | DCP7EVX | |
| 90098-72067 | BCPR7EKD | |
| 90098-72068 | BCPR6ED | |
| 90098-72070 | PFR7B-11 | |
| 90098-72078 | BK7EK-N-11 | |
| 90098-72116 | BPR7EIX | |
| 90098-74051 | DCPR8E | |
| 90098-74052 | DCPR8EVX | |
| 90098-77024 | BR9HS | |
| 90098-99201 | BCPR6EP-11 | |
| 90098-99202 | BCPR5EIX-11 | |
| 90098-99203 | BPR5EP-11 | |
| 90098-99204 | BCPR6EP-N-8 | |
| 90098-99205 | BKR6EP-11 | |
| 90098-99206 | BKR6EP-N-8 | |
| 90098-99207 | BKR5EP-11 | |
| 90098-99208 | BKR6EKP-11 | |
| 90919-01051 | BPR5ES | V-Line No. 6 |
| 90919-01056 | BP4EY | |
| 90919-01059 | BP5EY | |
| 90919-01061 | BP5EY | |
| 90919-01063 | BP6EK | |
| 90919-01064 | BPR5EY | V-Line No. 9 |
| 90919-01065 | BPR5EY | V-Line No. 9 |
| 90919-01083 | BP6EY | |
| 90919-01084 | BPR6EY | |
| 90919-01085 | BP4EY-11 | |
| 90919-01087 | BP5EK-A | |
| 90919-01088 | BPR6EK-A | |
| 90919-01089 | BPR6EK-A | |
| 90919-01091 | BPR5EY | V-Line No. 9 |
| 90919-01092 | BPR6EK-A | |
| 90919-01094 | BP5EY-11 | |
| 90919-01095 | BPR5EIX-11 | |
| 90919-01096 | BPR5EIX-11 | |
| 90919-01097 | BPR6EK-A | |
| 90919-01098 | BPR6EY | |
| 90919-01099 | BP4EY | |
| 90919-01100 | BP5EFS | |
| 90919-01101 | BP5EY | |
| 90919-01102 | BPR5EY | V-Line No. 9 |
| 90919-01103 | BPR4EY | |
| 90919-01104 | BPR5EY-11 | |
| 90919-01108 | BPR4EY-11 | |
| 90919-01109 | BPR4EY-11 | |
| 90919-01113 | BRE527Y-11 | |
| 90919-01114 | BRE527Y-11 | |
| 90919-01115 | BPR5EP-11 | |
| 90919-01116 | BPR5EP-11 | |



| TOYOTA | → NGK Typ | V-LINE |
|---------------|------------------|---------------|
| 90919-01117 | BE529Y-11 | |
| 90919-01118 | BE529Y-11 | |
| 90919-01119 | BRE529Y | |
| 90919-01120 | BRE529Y | |
| 90919-01121 | BCPR5EIX-11 | |
| 90919-01122 | BCPR5EIX-11 | |
| 90919-01123 | BRE529Y-11 | |
| 90919-01125 | BPR6EY-11 | V-Line No. 10 |
| 90919-01126 | BPR6EY-11 | V-Line No. 10 |
| 90919-01127 | BCPR6EP-11 | |
| 90919-01128 | BCPR6EP-11 | |
| 90919-01129 | BCPR5EY-11 | |
| 90919-01130 | BCPR5EY-11 | |
| 90919-01131 | BCPR6EY-11 | |
| 90919-01132 | BCPR6EY-11 | |
| 90919-01133 | BPR5EP-11 | |
| 90919-01134 | BPR5EP-13 | |
| 90919-01135 | BCPR6EIX-11 | |
| 90919-01136 | BCPR6EIX-11 | |
| 90919-01138 | BP6EY | |
| 90919-01139 | BP6EY-11 | |
| 90919-01143 | BPR5EP-11 | |
| 90919-01144 | BPR5EP-11 | |
| 90919-01145 | BCPR6EP-N-8 | |
| 90919-01146 | BCPR6EP-N-8 | |
| 90919-01147 | BPR6EP-8 | |
| 90919-01148 | BPR6EP-8 | |
| 90919-01149 | BCPR6EY | |
| 90919-01150 | BCPR6EY | |
| 90919-01151 | BCPR5EP-8 | |
| 90919-01152 | BCPR5EP-8 | |
| 90919-01153 | BCPR5EY-11 | |
| 90919-01154 | BCPR5EY | |
| 90919-01155 | BCRE527Y | |
| 90919-01156 | BCRE527Y | |
| 90919-01157 | BCPR6EIX-11 | |
| 90919-01158 | BCPR5EIX-11 | |
| 90919-01159 | BCPR5EY-11 | |
| 90919-01162 | BCPR6EP-8 | |
| 90919-01164 | BKR5EYA-11 | V-Line No. 39 |
| 90919-01165 | BKR5EYA-11 | V-Line No. 39 |
| 90919-01166 | BKR6EYA-11 | |
| 90919-01167 | BKR6EYA | |
| 90919-01168 | BKR5EP-11 | |
| 90919-01169 | BKR5EP-11 | |
| 90919-01170 | BCPR4EY-11 | |
| 90919-01172 | BKR6EP-N-8 | |
| 90919-01173 | BKR6EP-N-8 | |
| 90919-01176 | BKR5EYA | |
| 90919-01177 | BKR5EYA | |
| 90919-01178 | BKR6EP-11 | |
| 90919-01179 | BKR6EP-11 | |

| TOYOTA | → NGK Typ | V-LINE |
|------------------------------|------------------|---------------|
| 90919-01180 | BKR6EP-8 | |
| 90919-01181 | BKR6EP-8 | |
| 90919-01182 | BCPR6EIX-11 | |
| 90919-01184 | BKR6EY-11 | |
| 90919-01185 | BKR6EYA-11 | |
| 90919-01187 | BKR6EP-13 | |
| 90919-01188 | BKR6EP-13 | |
| 90919-01192 | BKR5EKB-11 | |
| 90919-01193 | BKR5EKB-11 | |
| 90919-01194 | BKR6EKP-11 | |
| 90919-01195 | BKR6EKP-11 | |
| 90919-01196 | BKR5EKP-11 | |
| 90919-01197 | BKR5EKP-11 | |
| 90919-01198 | BKR6EKB-11 | |
| 90919-01201 | BKR5EKP-13 | |
| 90919-01202 | BKR6EKB-11 | |
| 90919-01208 | BKR6EPA-8 | |
| 90919-01209 | BKR5EIX-11P | |
| 90919-01210 | IFR6T11 | |
| 90919-01213 | BKR6EPA-8 | |
| 90919-01214 | BKR5EIX-P | |
| 90919-01219 | BKR5EIX-11P | |
| 90919-01220 | BKR6EP-11 | |
| 90919-01221 | HB6AIX-11P | |
| 90919-01226 | HB6BIX-11P | |
| 90919-01230 | HB6BIX-11P | |
| 90919-01235 | LFR6C-11 | |
| 90919-01236 | LFR6C-11 | |
| 90919-01237 | IFR6T11 | |
| 90919-01242 | BKR5EYA-11 | V-Line No. 39 |
| 90919-01244 | BKR5EYA | |
| 90919-01245 | BKR5EYA | |
| 90919-01247 | DILFR6D11 | |
| 90919-01253 | ILKAR7B11 | |
| 90919-YZZAA | BCP5E | V-Line No. 16 |
| 90919-YZZAB | BCP6E | V-Line No. 17 |
| 90919-YZZAC | BKR6E-11 | V-Line No. 14 |
| 90919-YZZAD | BKR5EYA | |
| 90919-YZZAE | BKR5EYA-11 | V-Line No. 39 |
| 90919-YZZAF | BKR6EYA | |
| 90919-YZZAG | BKR6EYA-11 | |
| 90999-09006 | BP5EY | |
| 90999-09007 | BP6EY | |
| 99098-22695 | BP7ES | |
| UNIPART, SUREFIRE | → NGK Typ | V-LINE |
| GSP131 | BP5ES | V-Line No. 8 |
| GSP141 | BP5ES | V-Line No. 8 |
| GSP151 | BP6ES | V-Line No. 4 |
| GSP163 | BP6ES | V-Line No. 4 |
| GSP171 | BP6ES | V-Line No. 4 |



| UNIPART, SUREFIRE | → NGK Typ | V-LINE |
|------------------------------|------------------|---------------|
| GSP181 | BP7ES | |
| GSP191 | BP8ES | |
| GSP2004 | ZFR6F-11 | |
| GSP2007 | BKR6ES | V-Line No. 28 |
| GSP244 | BPR5ES | V-Line No. 6 |
| GSP263 | BPR6ES | V-Line No. 2 |
| GSP264 | BPR5ES | V-Line No. 6 |
| GSP281 | BPR7ES | V-Line No. 19 |
| GSP331 | BP5EFS | |
| GSP351 | BP5EFS | |
| GSP361 | BP6EFS | V-Line No. 5 |
| GSP381 | BP7EFS | |
| GSP4154 | AP6FS | |
| GSP4266 | B5HS | |
| GSP4352 | BP6ES | V-Line No. 4 |
| GSP4356 | BP6HS | V-Line No. 18 |
| GSP4362 | BP6ES | V-Line No. 4 |
| GSP4366 | BP6HS | V-Line No. 18 |
| GSP4372 | BP5ES | V-Line No. 8 |
| GSP4376 | BP5HS | |
| GSP4382 | BP5ES | V-Line No. 8 |
| GSP4452 | BPR7ES | V-Line No. 19 |
| GSP4462 | BPR6ES | V-Line No. 2 |
| GSP4472 | BPR5ES | V-Line No. 6 |
| GSP4552 | BCP7ES | |
| GSP4562 | BCP6ES | V-Line No. 17 |
| GSP4563 | BP6EFS | V-Line No. 5 |
| GSP4573 | BP5EFS | |
| GSP461 | BPR6EFS | V-Line No. 7 |
| GSP46515 | PTR5A-13 | V-Line No. 25 |
| GSP4652 | BCPR7ES | |
| GSP4662 | BKR6ES | V-Line No. 28 |
| GSP4663 | BPR6EFS | V-Line No. 7 |
| GSP531 | BP5HS | |
| GSP540 | B5HS | |
| GSP541 | BP6HS | V-Line No. 18 |
| GSP571 | BP7HS | |
| GSP634 | BKR5ES | V-Line No. 35 |
| GSP6356 | BP6HS | V-Line No. 18 |
| GSP6382 | BP5ES | V-Line No. 8 |
| GSP6452 | BPR7ES | V-Line No. 19 |
| GSP6462 | BPR6ES | V-Line No. 2 |
| GSP6468 | BPR6ES-11 | V-Line No. 13 |
| GSP6472 | BPR5ES | V-Line No. 6 |
| GSP664 | BKR6ES | V-Line No. 28 |
| GSP665 | BCP6ES | V-Line No. 17 |
| GSP6651 | PTR5A-13 | V-Line No. 25 |
| GSP6652 | BKR6ES | V-Line No. 28 |
| GSP6658 | BCPR7ES-11 | |
| GSP6662 | BKR6ES | V-Line No. 28 |
| GSP6663 | BPR6EFS | V-Line No. 7 |

| UNIPART, SUREFIRE | → NGK Typ | V-LINE |
|------------------------------|------------------|---------------|
| GSP6668 | BKR6ES-11 | V-Line No. 14 |
| GSP684 | BCPR7ES | |
| GSP685 | BCP7ES | |
| GSP761 | BP6FS | |
| GSP881 | BPR6FS | |
| GSP9652 | PFR6J | |
| GSP96SZ | PFR6N-11 | |
| GSP981 | AP6FS | |
| VOLVO | → NGK Typ | V-LINE |
| 1150278 | IFR6B11 | |
| 1367528 | BPR6ES | V-Line No. 2 |
| 1367529 | BPR6ES | V-Line No. 2 |
| 14FGR8CTU | BKR6EQUA | |
| 22401AA670 | IFR6B11 | |
| 270746 | BPR6ES | V-Line No. 2 |
| 271239 | IZFR6B | |
| 271603 | BKR6E | V-Line No. 28 |
| 271727 | BKR6E | V-Line No. 28 |
| 271758 | BKR7EVX-11 | |
| 30637308 | PFR6B | |
| 30637308791 | PFR6B | |
| 30637308887 | PFR6B | |
| 30637385 | LFR6D | |
| 30637385496A | LFR6D | |
| 30650843 | LFR6D | |
| 30713859 | LFR6D | |
| 30731383 | IFR6B11 | |
| 30731878 | TR6AP-13 | |
| 30751468889 | ILFR6B | |
| 30751469 | LFR6D | |
| 30751805 | ILFR6B | |
| 30751806 | ILFR6B | |
| 30777349 | TR6AP-13 | |
| 31216183 | ILFR6B | |
| 31216184 | ILFR6B | |
| 31216297 | ITR6F13 | |
| 31216525 | ITR6F13 | |
| 31216674 | ILFR6K8 | |
| 31272399 | ILFR6K8 | |
| 3517980 | BKR6ES | V-Line No. 28 |
| 3650843 | LFR6D | |
| 8642660 | BKR6EQUA | |
| 8642661 | BKR6EQUA | |
| 8670058 | BKR6EVX | |
| 8687990H939 | IFR6B11 | |
| 8692070 | PFR6B | |
| 8692071 | PFR6B | |
| 8692072 | PFR6B | |
| 8694749 | ITR6F13 | |
| 9146775901 | BKR6EQUA | |



| VOLVO | → NGK Typ | V-LINE |
|-----------------|------------------|---------------|
| 9146775907 | BKR6EQUA | |
| VW Group | → NGK Typ | V-LINE |
| 06H 905 601 A | PFR7S8EG | |
| 101 000 000 AB | BP6ESZ | |
| 101 000 001 AB | BP6ET | V-Line No. 1 |
| 101 000 001 AC | BP6ET | V-Line No. 1 |
| 101 000 001 AD | BP5ET-10 | |
| 101 000 001 AE | BP5ET | |
| 101 000 002 AB | BP6ESZ | |
| 101 000 003 AA | BCP7ET | |
| 101 000 004 AA | BCP7ET | |
| 101 000 005 AA | BP6ET | V-Line No. 1 |
| 101 000 005 AB | BP6ET | V-Line No. 1 |
| 101 000 005 AC | BP7ET | |
| 101 000 005 AD | BP5ET-10 | |
| 101 000 005 AE | BP5ET | |
| 101 000 005 AF | BP5ET | |
| 101 000 006 AB | BP6ESZ | |
| 101 000 006 AC | BP6ESZ | |
| 101 000 007 AA | BP6ET | V-Line No. 1 |
| 101 000 007 AB | BP6ET | V-Line No. 1 |
| 101 000 007 AC | BP5ET-10 | |
| 101 000 007 AD | BP6ET | V-Line No. 1 |
| 101 000 016 AA | PFR7B | |
| 101 000 016 AB | PFR6Q | V-Line No. 37 |
| 101 000 017 AA | BCP7ET | |
| 101 000 026 AA | BUR5ET | V-Line No. 22 |
| 101 000 026 AB | BUR6ET | V-Line No. 1 |
| 101 000 027 AA | BP6ET | V-Line No. 1 |
| 101 000 027 AB | BP5ET | |
| 101 000 027 AC | BP5ET-10 | |
| 101 000 028 AA | BCP7ET | |
| 101 000 029 AA | BU6EFSZ | |
| 101 000 029 AB | BUR6EFSZ | |
| 101 000 033 AA | BKUR6ET-10 | V-Line No. 24 |
| 101 000 033 AB | BKUR7ET | |
| 101 000 033 AC | BKUR5ET | V-Line No. 29 |
| 101 000 033 AF | BKUR6ET | V-Line No. 27 |
| 101 000 033 AG | BKUR5ET-10 | |
| 101 000 034 AA | BP6ESZ | |
| 101 000 035 AA | BKR5EKU | |
| 101 000 035 AB | BKR5EKU | |
| 101 000 035 AH | BKR5EKUP | |
| 101 000 035 HJ | BKR6EKUB | |
| 101 000 036 AA | BUR6ET | V-Line No. 1 |
| 101 000 036 AB | BUR5ET | V-Line No. 22 |
| 101 000 036 AC | BUR5ET-10 | V-Line No. 21 |
| 101 000 038 AA | BPR5EKU | |
| 101 000 038 AB | BPR5EKU | |
| 101 000 039 AA | BPR5EKU | |
| 101 000 039 AB | BPR5EKU | |

| VW Group | → NGK Typ | V-LINE |
|-----------------|------------------|---------------|
| 101 000 040 AC | BUR5ET | V-Line No. 22 |
| 101 000 040 AD | BUR6ET | V-Line No. 1 |
| 101 000 040 AE | BUR5ET-10 | V-Line No. 21 |
| 101 000 041 AC | BKUR6ET-10 | V-Line No. 24 |
| 101 000 041 AD | BKUR6ET | V-Line No. 27 |
| 101 000 041 AE | BKUR7ET | |
| 101 000 047 AA | BP5ES-A | |
| 101 000 047 AB | PGR6D | |
| 101 000 048 AA | BP5HS | |
| 101 000 049 AD | BKR6ETA-10 | |
| 101 000 050 AA | BUR5ET | V-Line No. 22 |
| 101 000 050 AB | BUR5ET-10 | V-Line No. 21 |
| 101 000 050 AC | BUR6ET | V-Line No. 1 |
| 101 000 051 AA | BKUR6ET-10 | V-Line No. 24 |
| 101 000 051 AB | BKUR7ET | |
| 101 000 052 AA | BUR6EFSZ | |
| 101 000 055 AA | BKR6EK | V-Line No. 20 |
| 101 000 060 AA | BKUR5ET-10 | |
| 101 000 062 AB | PZFR5D-11 | V-Line No. 34 |
| 101 000 063 AA | PFR6Q | V-Line No. 37 |
| 101 000 063 AB | PFR7N-E | |
| 101 000 063 AC | PFR7Q | |
| 101 000 065 AA | BKR6ETA-10 | |
| 101 100 068 AA | ZFR6S-Q | |
| 101 905 600 | PZFR5J-11 | |
| 101 905 600 A | PZFR6J-11 | |
| 101 905 600 B | PZFR6Q-11 | |
| 101 905 600 R1 | PZFR5J-11 | |
| 101 905 601 | PZFR5D-11 | V-Line No. 34 |
| 101 905 602 | KR8BI | |
| 101 905 606 | IZKR7B | |
| 101 905 606 A | IZKR7B | |
| 101 905 607 | BKR6EKUE | |
| 101 905 611 | PFR6U-11G | |
| 101 905 611 A | PFR6X-11 | |
| 101 905 611 C | PFR7G | |
| 101 905 616 | BKR6EQUA | |
| 101 905 617 | ZFR5P-G | |
| 101 905 617 C | ZFR6T-11G | |
| 101 905 617 R1 | ZFR5P-G | |
| 101 905 620 | PZFR5N-11T | |
| 101 905 621 | PFR7W-T | |
| 101 905 621 B | PFR6W-TG | |
| 101 905 621 C | PFR7W-TG | |
| 101 905 622 | ILZKR7A | |
| 101 905 626 | PZFR6R | |
| 400 905 619 | PFR7G | |
| 410 905 619 | KR8BI | |
| N 017 8011 | B5HS | |



| | | |
|--|------------------|---------------|
| ALFA ROMEO => siehe FIAT Group | | |
| AMG => siehe MERCEDES | | |
| AUDI => siehe VW Group | | |
| BENTLEY => siehe VW Group | | |
| BERU | → NGK Typ | V-LINE |
| 0100220113 | Y-204RS | |
| 0100220114 | Y-112M1 | |
| 0100220115 | Y-112R1 | |
| 0100220118 | Y-705RS | |
| 0100220206 | Y-403T | |
| 0100221101 | Y302 | |
| 0100221103 | Y-208T | |
| 0100221106 | Y-208T | |
| 0100221107 | Y-924J | D-Power 1 |
| 0100221132 | Y-907R | |
| 0100221133 | Y-924J | D-Power 1 |
| 0100221135 | Y-924J | D-Power 1 |
| 0100221141 | Y-909R | |
| 0100221144 | Y-910J | D-Power 3 |
| 0100221145 | Y-924J | D-Power 1 |
| 0100221146 | Y-910J | D-Power 3 |
| 0100221147 | Y-115T1 | |
| 0100221148 | Y-128T | |
| 0100221149 | Y-117RS | |
| 0100221151 | Y-118T1 | |
| 0100221152 | Y-204TS1 | |
| 0100221154 | Y-107R | |
| 0100221163 | Y-924J | D-Power 1 |
| 0100221170 | Y-739R | |
| 0100221186 | Y-306R | |
| 0100221206 | Y-404 | |
| 0100221209 | Y-403-1 | |
| 0100221210 | Y405 | |
| 0100221301 | Y-811 | |
| 0100222101 | Y-118R | |
| 0100222102 | Y-168R | |
| 0100222106 | Y-508J | |
| 0100222301 | Y-810 | |
| 0100222302 | Y-810 | |
| 0100226129 | Y-729U | D-Power 34 |
| 0100226163 | Y-913J | D-Power 15 |
| 0100226164 | Y-933J | D-Power 25 |
| 0100226170 | Y-712RS | |
| 0100226171 | Y-712RS | |
| 0100226173 | Y-918J | D-Power 2 |
| 0100226180 | Y-146R | |
| 0100226182 | Y-147T | |
| 0100226183 | Y-115R1 | |
| 0100226184 | Y-730U | D-Power 17 |

| | | |
|-------------|------------------|---------------|
| BERU | → NGK Typ | V-LINE |
| 0100226185 | Y-924J | D-Power 1 |
| 0100226186 | Y-924J | D-Power 1 |
| 0100226188 | Y-503J | D-Power 10 |
| 0100226189 | Y-924J | D-Power 1 |
| 0100226194 | Y-707RS | |
| 0100226198 | Y-910J | D-Power 3 |
| 0100226206 | Y-604J | |
| 0100226207 | Y-710J | |
| 0100226208 | Y-711J | D-Power 28 |
| 0100226209 | Y-307R | |
| 0100226227 | Y-732J | D-Power 4 |
| 0100226229 | Y-924J | D-Power 1 |
| 0100226234 | Y-916J | D-Power 6 |
| 0100226235 | Y-925J | D-Power 16 |
| 0100226237 | Y-933J | D-Power 25 |
| 0100226238 | Y-740U | D-Power 22 |
| 0100226243 | Y-715R | |
| 0100226245 | Y-506J | D-Power 7 |
| 0100226246 | Y-738U | |
| 0100226249 | Y-928U | D-Power 29 |
| 0100226250 | Y-929U | D-Power 41 |
| 0100226255 | Y-605J | |
| 0100226258 | Y-930U | D-Power 30 |
| 0100226299 | Y-927J | D-Power 19 |
| 0100226300 | Y-748U | D-Power 14 |
| 0100226336 | Y-701J | D-Power 39 |
| 0100226338 | Y-501U | D-Power 31 |
| 0100226343 | Y-741U | D-Power 20 |
| 0100226344 | Y-504J | D-Power 24 |
| 0100226351 | Y-517J | |
| 0100226352 | Y-530J | |
| 0100226354 | Y-502R | |
| 0100226362 | Y-507J | D-Power 32 |
| 0100226365 | Y-746J | D-Power 38 |
| 0100226366 | Y-924J | D-Power 1 |
| 0100226371 | Y-503J | D-Power 10 |
| 0100226372 | Y-747U | D-Power 26 |
| 0100226373 | Y-732J | D-Power 4 |
| 0100226375 | Y-516J | D-Power 12 |
| 0100226379 | Y-745U | D-Power 11 |
| 0100226381 | Y-937J | D-Power 5 |
| 0100226384 | Y-524J | D-Power 27 |
| 0100226385 | Y-525J | D-Power 35 |
| 0100226391 | Y-939J | D-Power 43 |
| 0100226392 | Y-543J | D-Power 46 |
| 0100226417 | Y-523J | D-Power 37 |
| 0100226422 | Y-749J | |
| 0100226432 | Y-926U | |
| 0100226436 | Y-534J | D-Power 36 |
| 0100226475 | Y-532J | |
| 0100226480 | Y-542J | D-Power 45 |
| 0100226482 | Y-741U | D-Power 20 |

* only by car dealer



| BERU | → NGK Typ | V-LINE |
|-------------|------------------|---------------|
| 0100226492 | Y1005J | D-Power 56 |
| 0100226495 | Y-603J | D-Power 60 |
| 0100226497 | Y-541J | D-Power 42 |
| 0100226527 | Y-531J | D-Power 44 |
| 0100230101 | Y-181T | |
| 0100230102 | Y-162R1 | |
| 0100230107 | Y-755RS | |
| 0100231104 | Y-157R | |
| 0100231107 | Y-197R | |
| 0100231109 | Y-757RS | |
| 0100231114 | Y-197T | |
| 0100266002 | Y-547AS | D-Power 47 |
| 0100266008 | Y-607AS | D-Power 50 |
| 0100266009 | YE14 | D-Power 48 |
| 0100266011 | Y8002AS | D-Power 51 |
| 0100266016 | Y-609AS | D-Power 49 |
| 0100266040 | Y1002AS | D-Power 57 |
| 0100276004 | YE04 | D-Power 40 |
| 0100276005 | YE12 | |
| 0100276008 | Y8003J | D-Power 62 |
| 0100276012 | YE05 | |
| 0100276014 | YE13 | |
| 0100276015 | YE07 | |
| 0100800031 | Y-519J | D-Power 61 |
| 105MN | Y-208T | |
| 106MJ | Y-403-1 | |
| 107MJ | Y-810 | |
| 108MJ | Y-810 | |
| 112M | Y302 | |
| 130MJ | Y405 | |
| 137MJ | Y-403T | |
| 155MJ | Y-404 | |
| 170MJ | Y-811 | |
| 602MJ | Y-208T | |
| 603MJ | Y-924J | D-Power 1 |
| 631MJ | Y-907R | |
| 636MJ | Y-924J | D-Power 1 |
| 642MJ | Y-924J | D-Power 1 |
| 657MJ | Y-909R | |
| 661MJ | Y-910J | D-Power 3 |
| 663MJ | Y-924J | D-Power 1 |
| 666MJ | Y-910J | D-Power 3 |
| 673MJ | Y-115T1 | |
| 678MJ | Y-128T | |
| 685MJ | Y-117RS | |
| 688MJ | Y-118T1 | |
| 689MJ | Y-204TS1 | |
| 705MJ | Y-107R | |
| 719MJ | Y-924J | D-Power 1 |
| 730MJ | Y-739R | |
| 749MJ | Y-306R | |
| 783MJ | Y-729U | D-Power 34 |

| BERU | → NGK Typ | V-LINE |
|-------------|------------------|---------------|
| 844MJ | Y-933J | D-Power 25 |
| 852MJ | Y-913J | D-Power 15 |
| 853MJ | Y-712RS | |
| 854MJ | Y-712RS | |
| 855MJ | Y-732J | D-Power 4 |
| 857MJ | Y-918J | D-Power 2 |
| 858MJ | Y-916J | D-Power 6 |
| 860MJ | Y-930U | D-Power 30 |
| 880MJ | Y-157R | |
| 886MJ | Y-146R | |
| 887MJ | Y-181T | |
| 888MJ | Y-204RS | |
| 889MJ | Y-112M1 | |
| 890MJ | Y-162R1 | |
| 892MJ | Y-112R1 | |
| 894MJ | Y-118R | |
| 895MJ | Y-197R | |
| 896MJ | Y-168R | |
| 897MJ | Y-147T | |
| 898MJ | Y-115R1 | |
| 905MJ | Y-730U | D-Power 17 |
| 908MJ | Y-924J | D-Power 1 |
| 909MJ | Y-924J | D-Power 1 |
| 912MJ | Y-503J | D-Power 10 |
| 917MJ | Y-924J | D-Power 1 |
| 920MJ | Y-705RS | |
| 921MJ | Y-707RS | |
| 922MJ | Y-757RS | |
| 927MJ | Y-910J | D-Power 3 |
| 944MJ | Y-604J | |
| 945MJ | Y-307R | |
| 946MJ | Y-710J | |
| 947MJ | Y-711J | D-Power 28 |
| 948MJ | Y-925J | D-Power 16 |
| 954MJ | Y-924J | D-Power 1 |
| 959MJ | Y-933J | D-Power 25 |
| 961MJ | Y-929U | D-Power 41 |
| 963MJ | Y-506J | D-Power 7 |
| 964MJ | Y-738U | |
| 968MJ | Y-715R | |
| 969MJ | Y-197T | |
| 970MJ | Y-928U | D-Power 29 |
| 991MJ | Y-927J | D-Power 19 |
| 999MJ | Y-740U | D-Power 22 |
| GE100 | Y-607AS | D-Power 50 |
| GE101 | YE14 | D-Power 48 |
| GE102 | Y-547AS | D-Power 47 |
| GE105 | Y8002AS | D-Power 51 |
| GE108 | Y-609AS | D-Power 49 |
| GE115 | Y1002AS | D-Power 57 |
| GN003 | Y-745U | D-Power 11 |
| GN005 | Y-701J | D-Power 39 |

* only by car dealer



| BERU | → NGK Typ | V-LINE |
|-------------|------------------|---------------|
| GN007 | Y-741U | D-Power 20 |
| GN008 | Y-501U | D-Power 31 |
| GN010 | Y-746J | D-Power 38 |
| GN012 | Y-502R | |
| GN013 | Y-924J | D-Power 1 |
| GN015 | Y-543J | D-Power 46 |
| GN016 | Y-503J | D-Power 10 |
| GN017 | Y-747U | D-Power 26 |
| GN018 | Y-732J | D-Power 4 |
| GN019 | Y-516J | D-Power 12 |
| GN022 | Y-937J | D-Power 5 |
| GN024 | Y-507J | D-Power 32 |
| GN026 | Y-517J | |
| GN027 | Y-504J | D-Power 24 |
| GN030 | Y-939J | D-Power 43 |
| GN033 | Y-523J | D-Power 37 |
| GN035 | Y-749J | |
| GN039 | Y-530J | |
| GN041 | Y-534J | D-Power 36 |
| GN042 | Y-542J | D-Power 45 |
| GN043 | Y-532J | |
| GN044 | Y-755RS | |
| GN045 | YE12 | |
| GN046 | Y-741U | D-Power 20 |
| GN047 | YE04 | D-Power 40 |
| GN053 | Y8003J | D-Power 62 |
| GN054 | Y1005J | D-Power 56 |
| GN056 | YE05 | |
| GN057 | Y-508J | |
| GN058 | YE13 | |
| GN059 | YE07 | |
| GN065 | Y-531J | D-Power 44 |
| GN103 | Y-603J | D-Power 60 |
| GN104 | Y-541J | D-Power 42 |
| GN109 | Y-519J | D-Power 61 |
| GN853 | Y-712RS | |
| GN854 | Y-712RS | |
| GN855 | Y-732J | D-Power 4 |
| GN857 | Y-918J | D-Power 2 |
| GN858 | Y-916J | D-Power 6 |
| GN860 | Y-930U | D-Power 30 |
| GN905 | Y-730U | D-Power 17 |
| GN908 | Y-924J | D-Power 1 |
| GN909 | Y-924J | D-Power 1 |
| GN912 | Y-503J | D-Power 10 |
| GN917 | Y-924J | D-Power 1 |
| GN925 | Y-926U | |
| GN927 | Y-910J | D-Power 3 |
| GN939 | Y-525J | D-Power 35 |
| GN944 | Y-604J | |
| GN948 | Y-925J | D-Power 16 |
| GN954 | Y-924J | D-Power 1 |

| BERU | → NGK Typ | V-LINE |
|-------------|------------------|---------------|
| GN959 | Y-933J | D-Power 25 |
| GN961 | Y-929U | D-Power 41 |
| GN963 | Y-506J | D-Power 7 |
| GN964 | Y-738U | |
| GN970 | Y-928U | D-Power 29 |
| GN985 | Y-605J | |
| GN991 | Y-927J | D-Power 19 |
| GN992 | Y-748U | D-Power 14 |
| GN993 | Y-524J | D-Power 27 |
| GN999 | Y-740U | D-Power 22 |
| GV105 | Y-208T | |
| GV106 | Y-403-1 | |
| GV107 | Y-810 | |
| GV108 | Y-810 | |
| GV112 | Y302 | |
| GV130 | Y405 | |
| GV137 | Y-403T | |
| GV155 | Y-404 | |
| GV170 | Y-811 | |
| GV602 | Y-208T | |
| GV603 | Y-924J | D-Power 1 |
| GV631 | Y-907R | |
| GV636 | Y-924J | D-Power 1 |
| GV642 | Y-924J | D-Power 1 |
| GV657 | Y-909R | |
| GV661 | Y-910J | D-Power 3 |
| GV663 | Y-924J | D-Power 1 |
| GV666 | Y-910J | D-Power 3 |
| GV673 | Y-115T1 | |
| GV678 | Y-128T | |
| GV685 | Y-117RS | |
| GV688 | Y-118T1 | |
| GV689 | Y-204TS1 | |
| GV705 | Y-107R | |
| GV719 | Y-924J | D-Power 1 |
| GV730 | Y-739R | |
| GV749 | Y-306R | |
| GV783 | Y-729U | D-Power 34 |
| GV844 | Y-933J | D-Power 25 |
| GV852 | Y-913J | D-Power 15 |
| GV880 | Y-157R | |
| GV886 | Y-146R | |
| GV887 | Y-181T | |
| GV888 | Y-204RS | |
| GV889 | Y-112M1 | |
| GV890 | Y-162R1 | |
| GV892 | Y-112R1 | |
| GV894 | Y-118R | |
| GV895 | Y-197R | |
| GV896 | Y-168R | |
| GV897 | Y-147T | |
| GV898 | Y-115R1 | |

* only by car dealer



| BERU | → NGK Typ | V-LINE |
|-------------|------------------|---------------|
| GV920 | Y-705RS | |
| GV921 | Y-707RS | |
| GV922 | Y-757RS | |
| GV945 | Y-307R | |
| GV946 | Y-710J | |
| GV947 | Y-711J | D-Power 28 |
| GV968 | Y-715R | |
| GV969 | Y-197T | |

| BMW | → NGK Typ | V-LINE |
|-----------------|------------------|---------------|
| 12 23 1 288 245 | Y-924J | D-Power 1 |
| 12 23 2 241 389 | Y-924J | D-Power 1 |
| 12 23 2 248 059 | Y-507J | D-Power 32 |
| 12 23 7 786 869 | Y-547AS | D-Power 47 |
| 1288245 | Y-924J | D-Power 1 |
| 2241389 | Y-924J | D-Power 1 |
| 2248059 | Y-507J | D-Power 32 |
| 7786869 | Y-547AS | D-Power 47 |

| BOSCH | → NGK Typ | V-LINE |
|---------------|------------------|---------------|
| 0 250 001 008 | DG237 | |
| 0 250 001 012 | DG237 | |
| 0 250 001 016 | DG237 | |
| 0 250 001 416 | DG237 | |
| 0 250 200 013 | Y-811 | |
| 0 250 200 014 | Y-810 | |
| 0 250 200 020 | Y-810 | |
| 0 250 200 035 | Y302 | |
| 0 250 200 037 | Y-404 | |
| 0 250 200 046 | Y-403-1 | |
| 0 250 200 048 | Y405 | |
| 0 250 200 049 | Y-207T | |
| 0 250 200 051 | Y-403T | |
| 0 250 200 052 | Y-207T | |
| 0 250 200 053 | Y-909R | |
| 0 250 200 054 | Y-208T | |
| 0 250 200 055 | Y-810 | |
| 0 250 200 056 | Y-208T | |
| 0 250 200 058 | Y-208T | |
| 0 250 200 059 | Y-208T | |
| 0 250 200 060 | Y-208T | |
| 0 250 200 063 | Y-207T | |
| 0 250 200 065 | Y-208T | |
| 0 250 200 068 | Y-208T | |
| 0 250 200 069 | Y-924J | D-Power 1 |
| 0 250 200 420 | Y-810 | |
| 0 250 200 451 | Y-403T | |
| 0 250 200 454 | Y-208T | |
| 0 250 200 456 | Y-208T | |
| 0 250 200 465 | Y-208T | |
| 0 250 200 468 | Y-208T | |
| 0 250 201 001 | Y-924J | D-Power 1 |

| BOSCH | → NGK Typ | V-LINE |
|---------------|------------------|---------------|
| 0 250 201 004 | Y-918J | D-Power 2 |
| 0 250 201 005 | Y-924J | D-Power 1 |
| 0 250 201 006 | Y-924J | D-Power 1 |
| 0 250 201 008 | Y-924J | D-Power 1 |
| 0 250 201 009 | Y-924J | D-Power 1 |
| 0 250 201 011 | Y-918J | D-Power 2 |
| 0 250 201 012 | Y-909R | |
| 0 250 201 013 | Y-924J | D-Power 1 |
| 0 250 201 015 | Y-918J | D-Power 2 |
| 0 250 201 017 | Y-907R | |
| 0 250 201 019 | Y-924J | D-Power 1 |
| 0 250 201 021 | Y-918J | D-Power 2 |
| 0 250 201 026 | Y-916J | D-Power 6 |
| 0 250 201 027 | Y-924J | D-Power 1 |
| 0 250 201 029 | Y-913J | D-Power 15 |
| 0 250 201 032 | Y-918J | D-Power 2 |
| 0 250 201 033 | Y-924J | D-Power 1 |
| 0 250 201 034 | Y-909R | |
| 0 250 201 035 | Y-930U | D-Power 30 |
| 0 250 201 038 | Y-925J | D-Power 16 |
| 0 250 201 039 | Y-924J | D-Power 1 |
| 0 250 201 041 | Y-916J | D-Power 6 |
| 0 250 201 042 | Y-924J | D-Power 1 |
| 0 250 201 043 | Y-913J | D-Power 15 |
| 0 250 201 049 | Y-937J | D-Power 5 |
| 0 250 201 050 | Y-933J | D-Power 25 |
| 0 250 201 053 | Y-939J | D-Power 43 |
| 0 250 201 405 | Y-924J | D-Power 1 |
| 0 250 201 415 | Y-918J | D-Power 2 |
| 0 250 202 001 | Y-910J | D-Power 3 |
| 0 250 202 002 | Y-739R | |
| 0 250 202 003 | Y-115T1 | |
| 0 250 202 004 | Y-128T | |
| 0 250 202 005 | Y-117RS | |
| 0 250 202 006 | Y-118T1 | |
| 0 250 202 007 | Y-107R | |
| 0 250 202 008 | Y-306R | |
| 0 250 202 009 | Y-732J | D-Power 4 |
| 0 250 202 013 | Y-204RS | |
| 0 250 202 015 | Y-103 | |
| 0 250 202 017 | Y-112R1 | |
| 0 250 202 018 | Y-910J | D-Power 3 |
| 0 250 202 020 | Y-503J | D-Power 10 |
| 0 250 202 022 | Y-732J | D-Power 4 |
| 0 250 202 023 | Y-741U | D-Power 20 |
| 0 250 202 024 | Y-927J | D-Power 19 |
| 0 250 202 025 | Y-730U | D-Power 17 |
| 0 250 202 026 | Y-929U | D-Power 41 |
| 0 250 202 028 | Y-504J | D-Power 24 |
| 0 250 202 029 | Y-745U | D-Power 11 |
| 0 250 202 030 | Y-543J | D-Power 46 |
| 0 250 202 032 | Y-504J | D-Power 24 |

* only by car dealer



| BOSCH | → NGK Typ | V-LINE |
|---------------|------------------|---------------|
| 0 250 202 033 | Y-910J | D-Power 3 |
| 0 250 202 034 | Y-928U | D-Power 29 |
| 0 250 202 035 | Y-506J | D-Power 7 |
| 0 250 202 036 | Y-534J | D-Power 36 |
| 0 250 202 040 | Y-729U | D-Power 34 |
| 0 250 202 041 | Y-746J | D-Power 38 |
| 0 250 202 042 | Y-748U | D-Power 14 |
| 0 250 202 043 | Y-523J | D-Power 37 |
| 0 250 202 051 | Y-146R | |
| 0 250 202 054 | Y-118R | |
| 0 250 202 058 | Y-147T | |
| 0 250 202 064 | Y-755RS | |
| 0 250 202 065 | Y-904M1 | |
| 0 250 202 069 | Y-162R1 | |
| 0 250 202 071 | Y-181T | |
| 0 250 202 076 | Y-197R | |
| 0 250 202 077 | Y-705RS | |
| 0 250 202 085 | Y-710J | |
| 0 250 202 086 | Y-307R | |
| 0 250 202 087 | Y-711J | D-Power 28 |
| 0 250 202 089 | Y-701J | D-Power 39 |
| 0 250 202 090 | Y1006J | |
| 0 250 202 092 | Y-733J | D-Power 13 |
| 0 250 202 093 | Y-712RS | |
| 0 250 202 094 | Y-115T1 | |
| 0 250 202 095 | Y-532J | |
| 0 250 202 096 | Y-118T1 | |
| 0 250 202 097 | Y-197T | |
| 0 250 202 102 | Y-501U | D-Power 31 |
| 0 250 202 103 | Y-507J | D-Power 32 |
| 0 250 202 107 | Y-157R | |
| 0 250 202 110 | Y-112T | |
| 0 250 202 119 | Y-178T | |
| 0 250 202 124 | Y1007J | D-Power 59 |
| 0 250 202 125 | Y-531J | D-Power 44 |
| 0 250 202 128 | Y-517J | |
| 0 250 202 129 | Y-516J | D-Power 12 |
| 0 250 202 131 | Y-524J | D-Power 27 |
| 0 250 202 135 | Y1005J | D-Power 56 |
| 0 250 203 001 | YE07 | |
| 0 250 203 002 | Y8003J | D-Power 62 |
| 0 250 203 004 | YE12 | |
| 0 250 204 001 | YE04 | D-Power 40 |
| 0 250 312 001 | CY51 | |
| 0 250 312 002 | CY52 | |
| 0 250 312 003 | CY03 | D-Power 8 |
| 0 250 312 007 | CY57 | D-Power 21 |
| 0 250 402 002 | Y-547AS | D-Power 47 |
| GA135 | DG237 | |
| GA1351 | DG237 | |
| GLP001 | Y-924J | D-Power 1 |
| GLP002 | Y-918J | D-Power 2 |

| BOSCH | → NGK Typ | V-LINE |
|--------------|------------------|---------------|
| GLP003 | Y-732J | D-Power 4 |
| GLP004 | Y-503J | D-Power 10 |
| GLP005 | Y-924J | D-Power 1 |
| GLP006 | Y-916J | D-Power 6 |
| GLP007 | Y-534J | D-Power 36 |
| GLP009 | Y-506J | D-Power 7 |
| GLP010 | Y-910J | D-Power 3 |
| GLP011 | Y-516J | D-Power 12 |
| GLP012 | Y-937J | D-Power 5 |
| GLP013 | Y-504J | D-Power 24 |
| GLP014 | Y-730U | D-Power 17 |
| GLP015 | Y-924J | D-Power 1 |
| GLP016 | Y8003J | D-Power 62 |
| GLP017 | Y-925J | D-Power 16 |
| GLP019 | Y-748U | D-Power 14 |
| GLP020 | Y-927J | D-Power 19 |
| GLP021 | Y-929U | D-Power 41 |
| GLP022 | Y-745U | D-Power 11 |
| GLP023 | Y-741U | D-Power 20 |
| GLP024 | Y-524J | D-Power 27 |
| GLP025 | Y-930U | D-Power 30 |
| GLP026 | Y-928U | D-Power 29 |
| GLP030 | Y-523J | D-Power 37 |
| GLP031 | Y-501U | D-Power 31 |
| GLP032 | Y-504J | D-Power 24 |
| GLP034 | Y-115T1 | |
| GLP035 | CY03 | D-Power 8 |
| GLP036 | Y-933J | D-Power 25 |
| GLP037 | Y-913J | D-Power 15 |
| GLP038 | Y-701J | D-Power 39 |
| GLP039 | CY57 | D-Power 21 |
| GLP040 | Y-507J | D-Power 32 |
| GLP041 | Y-739R | |
| GLP042 | Y-118T1 | |
| GLP043 | YE07 | |
| GLP045 | Y-939J | D-Power 43 |
| GLP046 | Y-711J | D-Power 28 |
| GLP047 | Y-909R | |
| GLP048 | Y-729U | D-Power 34 |
| GLP049 | Y-712RS | |
| GLP054 | Y-733J | D-Power 13 |
| GLP057 | Y-517J | |
| GLP059 | YE04 | D-Power 40 |
| GLP063 | Y-810 | |
| GLP070 | Y-547AS | D-Power 47 |
| GLP072 | Y-710J | |
| GLP074 | Y-532J | |
| GLP096 | Y-306R | |
| GLP098 | Y-755RS | |
| GLP101 | Y-531J | D-Power 44 |
| GLP102 | Y-746J | D-Power 38 |
| GLP103 | Y-904M1 | |

* only by car dealer



| BOSCH | → NGK Typ | V-LINE |
|--------------|------------------|---------------|
| GLP105 | CY52 | |
| GLP108 | CY51 | |
| GLP111 | Y1005J | D-Power 56 |
| GLP115 | YE12 | |
| GLP116 | Y-118R | |
| GLP117 | Y-107R | |
| GLP120 | Y-307R | |
| GLP121 | Y-910J | D-Power 3 |
| GLP124 | Y-146R | |
| GLP125 | Y-103 | |
| GLP127 | Y-705RS | |
| GLP128 | Y-403T | |
| GLP130 | Y302 | |
| GLP132 | Y-197T | |
| GLP133 | Y-543J | D-Power 46 |
| GLP136 | Y-197R | |
| GLP137 | Y1007J | D-Power 59 |
| GLP138 | Y-162R1 | |
| GLP142 | Y-147T | |
| GLP152 | Y-178T | |
| GLP155 | Y-112T | |
| GLP156 | Y1006J | |
| GLP159 | Y-128T | |
| GLP167 | Y-117RS | |
| GLP169 | Y-157R | |
| GLP171 | Y-404 | |
| GLP172 | Y-403-1 | |
| GLP185 | Y-181T | |
| GLP186 | Y-907R | |
| GSA101 | Y-810 | |
| GSA91 | Y-810 | |
| KEGA121 | DG237 | |
| KEGA1211 | DG237 | |
| KEGSA1010 | Y-811 | |

| BRISK | → NGK Typ | V-LINE |
|--------------|------------------|---------------|
| 21N21 | Y-208T | |
| 21N22 | Y-208T | |
| 21N51 | Y-909R | |
| 21R01 | Y-918J | |
| 21R02 | Y-907R | |
| 21R06 | Y-918J | D-Power 2 |
| 21R21 | Y-924J | D-Power 1 |
| 21R22 | Y-924J | D-Power 1 |
| 21R23 | Y-924J | D-Power 1 |
| 21R26 | Y-913J | D-Power 15 |
| 21R51 | Y-909R | |
| 21R71 | Y-910J | D-Power 3 |
| 41N71 | Y-403T | |

BUICK => siehe GM

| CADILLAC => siehe GM | | |
|--------------------------------|------------------|---------------|
| CHAMPION | → NGK Typ | V-LINE |
| AG32 | Y302 | |
| AG44 | Y-811 | |
| CH101 / 002 | Y-115R1 | |
| CH102 / 002 | Y-112M1 | |
| CH103 / 002 | Y-118T1 | |
| CH104 / 002 | Y-197R | |
| CH105 / 002 | Y-204SS | |
| CH121 / 002 | Y-118T1 | |
| CH137 / 002 | Y-924J | D-Power 1 |
| CH147 / 002 | Y-910J | D-Power 3 |
| CH154 / 002 | Y-715R | |
| CH158 / 002 | Y-711J | D-Power 28 |
| CH159 / 002 | Y-924J | D-Power 1 |
| CH160 / 002 | Y-918J | D-Power 2 |
| CH161 / 002 | Y-755RS | |
| CH162 / 002 | Y-707RS | |
| CH163 / 002 | Y-924J | D-Power 1 |
| CH166 / 002 | Y-747U | D-Power 26 |
| CH167 / 002 | Y-928U | D-Power 29 |
| CH169 / 002 | Y-730U | D-Power 17 |
| CH170 / 002 | Y-504J | D-Power 24 |
| CH171 / 002 | Y-732J | D-Power 4 |
| CH172 / 002 | Y-740U | D-Power 22 |
| CH173 / 002 | Y-913J | D-Power 15 |
| CH174 / 002 | Y-924J | D-Power 1 |
| CH175 / 002 | Y-930U | D-Power 30 |
| CH176 / 002 | Y-916J | D-Power 6 |
| CH177 / 002 | Y-925J | D-Power 16 |
| CH178 / 002 | Y-729U | D-Power 34 |
| CH179 / 002 | Y-933J | D-Power 25 |
| CH181 / 002 | Y-741U | D-Power 20 |
| CH184 / 002 | Y-732J | D-Power 4 |
| CH185 / 002 | Y-503J | D-Power 10 |
| CH189 / 002 | Y-924J | D-Power 1 |
| CH196 / 002 | Y-524J | D-Power 27 |
| CH203 / 002 | Y-507J | D-Power 32 |
| CH204 / 002 | Y-929U | D-Power 41 |
| CH205 / 002 | Y-937J | D-Power 5 |
| CH206 / 002 | Y-927J | D-Power 19 |
| CH207 / 002 | Y-748U | D-Power 14 |
| CH208 / 002 | Y-738U | |
| CH215 / 002 | Y-501U | D-Power 31 |
| CH216 / 002 | Y-502R | |
| CH217 / 002 | Y-506J | D-Power 7 |
| CH218 / 002 | Y-745U | D-Power 11 |
| CH219 / 002 | Y-746J | D-Power 38 |
| CH221 / 002 | Y-115T1 | |
| CH223 / 002 | Y8003J | D-Power 62 |
| CH224 / 002 | YE07 | |
| CH263 | Y1007J | D-Power 59 |

* only by car dealer



| CHAMPION | → NGK Typ | V-LINE |
|----------------------------------|------------------|---------------|
| CH268 | Y1005J | D-Power 56 |
| CH32 / 002 | Y302 | |
| CH44 / 002 | Y-811 | |
| CH60 / 002 | Y-207T | |
| CH600 / 002 | CY52 | |
| CH601 / 002 | CY03 | D-Power 8 |
| CH602 / 002 | CY57 | D-Power 21 |
| CH61 / 002 | DG237 | |
| CH63 / 002 | Y-208T | |
| CH64 / 002 | Y-404 | |
| CH65 / 002 | Y-810 | |
| CH66 / 002 | Y-403T | |
| CH68 / 002 | Y-523J | D-Power 37 |
| CH69 / 002 | Y-918J | |
| CH70 / 002 | Y-909R | |
| CH79 / 002 | Y-907R | |
| CH87 / 002 | Y-208T | |
| CH88 / 002 | Y-924J | D-Power 1 |
| CH90 / 002 | Y-739R | |
| CH94 / 002 | Y-115T1 | |
| CH95 / 002 | Y-146R | |
| CH96 / 002 | Y-204RS | |
| CH97 / 002 | Y-107R | |
| CH98 / 002 | Y-117RS | |
| CH99 / 002 | Y-117SS | |
| CHEVROLET => siehe GM | | |
| CITROEN => siehe PSA | | |
| DACIA => siehe RENAULT | | |
| DAEWOO => siehe GM | | |
| DAIHATSU | → NGK Typ | V-LINE |
| 19850-54050-000 | Y-118R | |
| 19850-54071-000 | Y-146R | |
| 19850-54090-000 | Y-715R | |
| 19850-56010-000 | Y-178 | |
| 19850-56012-000 | Y-178T | |
| 19850-58030-000 | Y-128T | |
| 19850-58040-000 | Y-178T | |
| 19850-64010-000 | Y-146R | |
| 19850-64020-000 | Y-703R | |
| 19850-68010-000 | Y-147T | |
| 19850-68040-000 | Y-178T | |
| 19850-68060-000 | Y-197R | |
| 19850-87303-000 | Y-108 | |
| 19850-87309-000 | Y-128T | |
| 19850-87311-000 | Y178TS1 | |
| 19850-87312-000 | Y178TS2 | |
| 19850-87701-000 | Y-146R | |

| DAIHATSU | → NGK Typ | V-LINE |
|-----------------|------------------|---------------|
| 19850-87702-000 | Y-703R | |
| 19850-87801 | Y-706R | |
| DENSO | → NGK Typ | V-LINE |
| 671000160 | DG-211 | |
| 671001042 | Y-402-2 | |
| 671001043 | Y-452-1 | |
| 671001070 | Y-176 | |
| 671001071 | Y-176 | |
| 671001090 | Y-108 | |
| 671001120 | Y-178 | |
| 671001130 | Y-128 | |
| 671001161 | Y-178T | |
| 671001170 | Y-128T | |
| 671001171 | Y-128T | |
| 671001270 | Y-118T1 | |
| 671001330 | Y-147T | |
| 671001340 | Y-197T | |
| 671001350 | Y-128T | |
| 671001360 | Y-178T | |
| 671001370 | Y-118R | |
| 671001380 | Y-168R | |
| 671001430 | Y-146R | |
| 671001460 | Y-197R | |
| 671001530 | Y-146R | |
| 671001630 | Y-118T1 | |
| DG001 | Y-924J | D-Power 1 |
| DG002 | Y-204TS1 | |
| DG003 | Y-503J | D-Power 10 |
| DG004 | Y-910J | D-Power 3 |
| DG005 | Y-732J | D-Power 4 |
| DG006 | Y-913J | D-Power 15 |
| DG007 | Y-937J | D-Power 5 |
| DG008 | Y-506J | D-Power 7 |
| DG009 | Y-927J | D-Power 19 |
| DG010 | Y-916J | D-Power 6 |
| DG101 | Y-740U | D-Power 22 |
| DG102 | Y-928U | D-Power 29 |
| DG103 | Y-933J | D-Power 25 |
| DG104 | Y711RS | |
| DG105 | Y-115T1 | |
| DG106 | Y-925J | D-Power 16 |
| DG110 | Y-929U | D-Power 41 |
| DG111 | Y-502R | |
| DG113 | YE04 | D-Power 40 |
| DG115 | Y-729U | D-Power 34 |
| DG116 | Y-504J | D-Power 24 |
| DG117 | Y-925J | D-Power 16 |
| DG118 | Y-748U | D-Power 14 |
| DG119 | Y-930U | D-Power 30 |
| DG120 | Y-707RS | |
| DG123 | Y-907R | |

* only by car dealer



| DENSO | → NGK Typ | V-LINE |
|--------------|------------------|---------------|
| DG124 | Y-710J | |
| DG126 | Y-517J | |
| DG127 | Y-747U | D-Power 26 |
| DG137 | Y-712RS | |
| DG144 | Y-732J | D-Power 4 |
| DG145 | Y-507J | D-Power 32 |
| DG146 | Y-701J | D-Power 39 |
| DG155 | Y-746J | D-Power 38 |
| DG159 | Y-307R | |
| DG161 | Y-924J | D-Power 1 |
| DG170 | YE07 | |
| DG171 | Y8003J | D-Power 62 |
| DG202 | Y-909R | |
| DG211 | Y-715R | |
| DG214 | Y-532J | |
| DG215 | Y-118R | |
| DG216 | Y-703R | |
| DG221 | Y-118T1 | |
| DG222 | Y-197R | |
| DG223 | Y-146R | |
| DG232 | Y-147T | |
| DG233 | Y-197T | |
| DG234 | Y-128T | |
| DG235 | Y-178T | |
| DG239 | Y-168R | |
| DG-240 | Y-542J | D-Power 45 |
| DG245 | Y-531J | D-Power 44 |
| DG300 | CY03 | D-Power 8 |
| DG301 | CY57 | D-Power 21 |
| DG304 | CY52 | |

DODGE => siehe CHRYSLER

| EIKO | → NGK Typ | V-LINE |
|-------------|------------------|---------------|
| GD901 | Y-108 | |
| GF101 | Y-175-2 | |
| GF102 | Y-201 | |
| GF103 | Y-274 | |
| GF104 | Y-172 | |
| GF105 | Y-172 | |
| GF106 | Y-102 | |
| GF108 | Y-251 | |
| GF109 | Y-251 | |
| GF110 | Y-180 | |
| GF111 | Y8022 | |
| GF112 | Y-115T1 | |
| GH401 | Y-173 | |
| GH402 | Y-176 | |
| GI001 | Y-874-1 | |
| GI002 | Y8081 | |
| GI003 | Y-104 | |
| GI007 | Y-154 | |

| EIKO | → NGK Typ | V-LINE |
|-------------|------------------|---------------|
| GI008 | Y-271-2 | |
| GM501 | Y-107T | |
| GM502 | Y-107R | |
| GM503 | Y-157R | |
| GM504 | Y-172 | |
| GN302 | Y-103 | |
| GN303 | Y-103-2 | |
| GN304 | Y-202 | |
| GN305 | Y-252 | |
| GN306 | Y-112T | |
| GN308 | Y-181T | |
| GN309 | Y-204TS1 | |
| GN310 | Y-103-1 | |
| GN311 | Y-272R1 | |
| GT201 | Y-402-2 | |
| GT202 | Y-452-1 | |
| GT203 | Y-128 | |
| GT204 | Y-178 | |
| GT207 | Y-178T | |
| GT208 | Y-128T | |
| GT211 | DG-211 | |
| GT212 | Y-146R | |

| EUROCARB | → NGK Typ | V-LINE |
|-----------------|------------------|---------------|
| 111 | Y-918J | D-Power 2 |

| FIAT Group | → NGK Typ | V-LINE |
|-------------------|------------------|---------------|
| 46447610 | Y-928U | D-Power 29 |
| 46451951 | Y-747U | D-Power 26 |
| 46751764 | Y-939J | D-Power 43 |
| 46754154 | Y-534J | D-Power 36 |
| 46792359 | YE07 | |
| 46796050 | Y8003J | D-Power 62 |
| 500316493 | Y-502R | |
| 60507123 | Y-909R | |
| 60812292 | Y-924J | D-Power 1 |
| 60814613 | Y-747U | D-Power 26 |
| 71719015 | Y-924J | D-Power 1 |
| 7735920 | Y-924J | D-Power 1 |
| 9633214380 | Y-924J | D-Power 1 |
| 9638985980 | Y-504J | D-Power 24 |
| 96515836 | Y1005J | D-Power 56 |
| 98462492 | Y-926U | |

| FORD | → NGK Typ | V-LINE |
|---------------|------------------|---------------|
| 10 37 204 | YE04 | D-Power 40 |
| 11 48 105 | YE04 | D-Power 40 |
| 13 13 809 | Y1005J | D-Power 56 |
| 14 27 905 | YE08 | |
| 18 54 421 | Y-408JS | |
| 2S6Q-6M090-AA | YE04 | D-Power 40 |
| 3M5Q-6M090-AB | Y1005J | D-Power 56 |

* only by car dealer



| FORD | → NGK Typ | V-LINE |
|---------------------|------------------|---------------|
| 40 25 139 | Y-701J | D-Power 39 |
| 6G9Q-6M090-AA | YE08 | |
| 95VW-6M090-AB | YE04 | D-Power 40 |
| XM341-2A342-BA | Y-701J | D-Power 39 |
| | | |
| GM | → NGK Typ | V-LINE |
| 93 178 411 | YE07 | |
| 94 133 759 | Y-904M1 | |
| 94 439 218 | Y-306R | |
| | | |
| HINO | → NGK Typ | V-LINE |
| 19110-1040 | Y-176 | |
| 1985A-56010 | Y-178 | |
| 1985A-56012 | Y-178T | |
| 1985A-56022 | Y-128T | |
| 1985A-68060 | Y-197R | |
| 60543-30901 | Y-173 | |
| 63013-30010 | Y-176 | |
| | | |
| HONDA | → NGK Typ | V-LINE |
| 31800-706-000 | YS-101 | |
| | | |
| HYUNDAI | → NGK Typ | V-LINE |
| 36710-27000 | Y-749J | |
| 36710-42000 | Y-722JS | |
| 36710-42020 | Y-722JS | |
| 36710-42500 | CY57 | D-Power 21 |
| 36710-42510 | CY57 | D-Power 21 |
| | | |
| ISHIKAWAJIMA | | |
| SHIBAUR | → NGK Typ | V-LINE |
| 185366010 | Y-401-3 | |
| 185366020 | Y-122 | |
| 185366040 | Y-107-1 | |
| 185366060 | Y-107V | |
| 185366080 | Y-107R | |
| | | |
| ISIKAWAZIM | → NGK Typ | V-LINE |
| 185366092 | Y-701J | |
| 185366110 | Y-119V | |
| 185366180 | Y-701U | |
| 185366190 | Y-701RS | |
| 185366220 | YE01 | |
| 185366230 | Y-701J | |
| | | |
| ISUZU | → NGK Typ | V-LINE |
| 5-86101642-0 | CY58 | |
| 5-86101643-0 | Y-712RS | |
| 5-86101644-0 | Y-707RS | |
| 5-86115977-0 | Y-757RS | |
| 8-84402303-1 | Y-711J | D-Power 28 |
| 8-94135377-3 | Y-954M1 | |

| ISUZU | → NGK Typ | V-LINE |
|----------------|------------------|---------------|
| 8-94175158-0 | Y-904M1 | |
| 8-94175158-1 | Y-904M1 | |
| 8-94175158-2 | Y-904M1 | |
| 8-94221719-3 | Y-954M1 | |
| 8-94319700-1 | Y-710J | |
| 8-94319700-2 | Y-710J | |
| 8-94319700-4 | Y-710J | |
| 8-94481972-0 | Y711RS | |
| 8-97033761-0 | Y-954M1 | |
| 8-97033761-1 | Y-954M1 | |
| 8-97033761-2 | Y-954M1 | |
| 8-97080554-0 | CY03 | D-Power 8 |
| 8-97080554-1 | CY03 | D-Power 8 |
| 8-97106549-1 | Y-720U1 | |
| -94175158- | Y-904M1 | |
| 9-82511945-0 | Y-874-1 | |
| 9-82511978-0 | Y-104 | |
| 9-82511978-1 | Y-104 | |
| 9-82511994-0 | Y-874-1 | |
| 9-82513928-2 | Y-271-2 | |
| 9-82513959-0 | Y-154 | |
| | | |
| KIA | → NGK Typ | V-LINE |
| 0 K04S 18 140A | Y-721J | |
| 0 K054 18 140 | Y-701J | D-Power 39 |
| 3 6710 27 010 | Y-749J | |
| 3 6710 4A 000 | Y-508J | |
| 3 6710 4A 100 | Y-508J | |
| | | |
| KOMATSU | → NGK Typ | V-LINE |
| 6008-15-2760 | Y-703R | |
| | | |
| KUBOTA | → NGK Typ | V-LINE |
| 15101-6551-1 | DG220A | |
| 15109-6509-1 | Y8091 | |
| 15109-6559-1 | Y8091 | |
| 15204-6551-1 | Y-110 | |
| 15221-6551-3 | Y-106-1 | |
| 15231-6551-2 | Y-107-1 | |
| 15261-6551-2 | Y-103K | |
| 15261-6551-4 | Y-103K | |
| 15451-6551-1 | Y-203 | |
| 15521-6551-0 | Y-106V | |
| 15521-6551-2 | Y-106V | |
| 15571-6551-1 | Y-203V | |
| 15571-6551-2 | Y-203V | |
| 15694-6551-2 | Y-702R | |
| 15694-6551-3 | Y-702R | |
| 15806-6551-2 | Y-706R | |
| 15806-6551-3 | Y-706R | |
| 15951-6551-1 | Y-103V | |
| 15951-6551-2 | Y-103V | |

* only by car dealer



| KUBOTA | → NGK Typ | V-LINE |
|---------------|------------------|---------------|
| 15951-6551-3 | Y-103V | |
| 16065-6551-1 | YE03 | |
| 16241-6551-1 | Y-709R | |
| 16241-6551-2 | Y-709R | |
| 16292-6551-1 | Y709RS | |
| 16415-6551-1 | Y-713R | |
| 16415-6551-2 | Y-713R | |
| 16665-6551-2 | Y-766MS | |
| 16695-6551-1 | Y303 | |
| 16695-6551-2 | Y303 | |
| 16851-6551-0 | YA01 | |
| 16851-6551-2 | YE01 | |
| 16881-6551-3 | YE52 | |
| 17331-6551-1 | Y-119V | |
| 17529-6551-1 | YA01 | |
| 19077-6551-1 | Y-716RS | |
| 19077-6551-2 | Y-716RS | |
| 19077-6551-3 | Y-716RS | |
| 19215-6551-1 | Y-149 | |
| 19215-6551-2 | Y-149 | |
| 19215-6551-3 | Y-149 | |
| 19821-6551-1 | Y301V | |
| 19821-6551-3 | Y301V | |
| 19872-6551-1 | Y756M | |
| 19883-6551-1 | Y-752M | |
| 8412 | Y-103K | |

LANCIA => siehe FIAT Group

LEXUS => siehe TOYOTA

| MARELLI | → NGK Typ | V-LINE |
|----------------|------------------|---------------|
| 061830024304 | Y-918J | |
| 061830025304 | Y-924J | D-Power 1 |
| 061830078304 | Y-924J | D-Power 1 |
| TIX1A | Y-207T | |
| TIX2A | Y-208T | |
| TIX4A | Y-208T | |
| TIX6A | Y-208T | |
| UX1A | Y-918J | |
| UX2A | Y-924J | D-Power 1 |
| UX4A | Y-924J | D-Power 1 |

| MAZDA | → NGK Typ | V-LINE |
|--------------|------------------|---------------|
| 1304 18 140 | Y-172 | |
| 1353 18 140 | Y-107T | |
| 1353 18 140A | Y-107T | |
| 1N01 18 601A | CY51 | |
| 1N02 18 601 | CY52 | |
| 4869 18 140 | Y-122 | |
| 4869 18 140A | Y-122 | |
| R2L2 18 601 | Y-721RS | |

| MAZDA | → NGK Typ | V-LINE |
|--------------|------------------|---------------|
| RF2A 18 601 | Y-529J | |
| RFG1 18 601 | Y-701J | D-Power 39 |
| RFJ5 18 601 | Y-701J | D-Power 39 |
| RFS5 18 601 | Y1006J | |
| RFS5 18 601A | Y1006J | |
| S201 18 140 | Y-107R | |
| S210 18 140 | Y-701J | D-Power 39 |
| S501 18 140A | Y-107R | |
| SE01 18 140A | Y-157R | |
| SEM1 18 601 | Y-771R | |
| US01 18 601 | Y721R | |
| VS01 18 601 | Y-721RS | |
| WL03 18 601 | Y-701J | D-Power 39 |
| WL81 18 601 | Y-701J | |
| Y701 18 601 | CY03 | D-Power 8 |

| MERCEDES | → NGK Typ | V-LINE |
|-----------------|------------------|---------------|
| 000 159 61 01 | DG237 | |
| 000 159 81 01 | Y-924J | D-Power 1 |
| 001 159 15 01 | Y-930U | D-Power 30 |
| 001 159 20 01 | Y-925J | D-Power 16 |
| 001 159 21 01 | Y-925J | D-Power 16 |
| 001 159 26 01 | Y-929U | D-Power 41 |
| 001 159 27 01 | Y-746J | D-Power 38 |
| 001 159 28 01 | Y-745U | D-Power 11 |
| 001 159 35 01 | Y-924J | D-Power 1 |
| 001 159 36 01 | Y-916J | D-Power 6 |
| 001 159 46 10 | YE13 | |
| 001 159 50 01 | Y8002AS | D-Power 51 |
| 001 159 56 01 | CZ106 | D-Power 53 |
| 001 159 57 01 | CZ303 | D-Power 54 |
| 001 159 66 01 | CZ303 | D-Power 54 |
| 001 159 68 01 | CZ106 | D-Power 53 |
| 667 159 00 01 | Y-537AS | |
| A 000 159 61 01 | DG237 | |
| A 000 159 81 01 | Y-924J | D-Power 1 |
| A 001 159 15 01 | Y-930U | D-Power 30 |
| A 001 159 20 01 | Y-925J | D-Power 16 |
| A 001 159 21 01 | Y-925J | D-Power 16 |
| A 001 159 26 01 | Y-929U | D-Power 41 |
| A 001 159 27 01 | Y-746J | D-Power 38 |
| A 001 159 28 01 | Y-745U | D-Power 11 |
| A 001 159 35 01 | Y-924J | D-Power 1 |
| A 001 159 36 01 | Y-916J | D-Power 6 |
| A 001 159 46 10 | YE13 | |
| A 001 159 50 01 | Y8002AS | D-Power 51 |
| A 001 159 56 01 | CZ106 | D-Power 53 |
| A 001 159 57 01 | CZ303 | D-Power 54 |
| A 001 159 66 01 | CZ303 | D-Power 54 |
| A 001 159 68 01 | CZ106 | D-Power 53 |
| A 667 159 00 01 | Y-537AS | |

* only by car dealer



| MINI => siehe BMW | | |
|-----------------------------|------------------|---------------|
| MITSUBISHI | → NGK Typ | V-LINE |
| 30666-57301 | Y-114T | |
| 30666-57302 | Y-114T | |
| 30666-57303 | Y-114T | |
| 30L66-00300 | Y-723R | |
| 30L66-00301 | Y-723R | |
| 30L66-00302 | Y-723R | |
| 30L66-00400 | Y-723U | |
| 30L66-004009V | Y-723U | |
| 30L66-00401 | Y-723U | |
| 30L66-00402 | Y-723U | |
| 31366-02100 | Y-251 | |
| 31366-02109 | Y-251 | |
| 31366-14300 | Y-201 | |
| 31366-14301 | Y-201 | |
| 31366-14302 | Y-201 | |
| 31366-14701 | Y-251 | |
| 31766-01100 | Y-251 | |
| 31A66 | Y724U | |
| 31A66-03100 | Y-701U | |
| 31A66-03101 | Y-701U | |
| 31A66-03102 | Y-701U | |
| 31A66-03200 | Y724U | |
| 31A66-13200 | Y724U | |
| 32A66-07010 | Y-904M1 | |
| 32A66-07020 | Y954M | |
| 32A66-07021 | Y-954M1 | |
| 32A66-07100 | Y-904M1 | |
| 32A66-07200 | Y-954M1 | |
| 32C98-55808 | Y-722JS | |
| 34466-21300 | Y-182T | |
| 34466-21301 | Y-182T | |
| 34466-31301 | Y-182T1 | |
| 36710-42500 | CY57 | D-Power 21 |
| 91304-04300 | Y-701J | D-Power 39 |
| EE 960 01 | Y-173 | |
| EE 960 02 | Y-104 | |
| EE 960 39 | Y-154 | |
| K4 171 313 | Y8022 | |
| K4 171 363 | Y8522 | |
| K6 571 342 | Y8762 | |
| K9 670 240 | Y-201 | |
| M8 167 32 | Y-933J | D-Power 25 |
| MD 014 997 | Y-115R1 | |
| MD 050 212 | Y-115T1 | |
| MD 077 167 | Y-707RS | |
| MD 171 581 | Y772R | |
| MD 197 511 | CY57 | D-Power 21 |
| MD 301 950 | Y-733J | D-Power 13 |
| MD 344 469 | Y-733J | D-Power 13 |
| ME 017 009 | Y-274R | |

| MITSUBISHI | → NGK Typ | V-LINE |
|-------------------|------------------|---------------|
| ME 017 010 | Y-274 | |
| ME 017 013 | Y-274 | |
| ME 017 057 | Y-971M | |
| ME 200 970 | CY55 | |
| ME 201 638 | CY55 | |
| ME 203 539 | Y1007J | D-Power 59 |
| ME 203 754 | CY55 | |
| MM 105 560 | Y-251 | |
| MM 401 621 | Y-110 | |
| MM 401 621 01 | Y-110 | |
| MM 401 621 02 | Y-110 | |
| MM 401 625 | Y160 | |
| MM 401 625 01 | Y160 | |
| MM 401 625 02 | Y160 | |
| MM 431 439 01 | Y-142T | |
| MM 432 148 | Y-145T | |
| MN 960 270 | YE13 | |
| MN 960 296 | YE13 | |
| MR 577 131 | Y-733J | D-Power 13 |
| MOTORCRAFT | → NGK Typ | V-LINE |
| 1037204 | Y-732J | D-Power 4 |
| 1056857 | Y-937J | D-Power 5 |
| 1079401 | Y-524J | D-Power 27 |
| 1096527 | Y-525J | D-Power 35 |
| 1690048 | Y-741U | D-Power 20 |
| 3252725 | Y-107R | |
| 5023372 | Y-208T | |
| 5031006 | Y-924J | D-Power 1 |
| 6132246 | Y-907R | |
| 6154593 | Y-924J | D-Power 1 |
| 7088988 | Y-910J | D-Power 3 |
| 84BB6M090AA | Y-924J | D-Power 1 |
| 84FF6M090B2A | Y-907R | |
| 93FF6M090AA | Y-910J | D-Power 3 |
| 95VW6M090AB | Y-732J | D-Power 4 |
| 96FF6M090CA | Y-937J | D-Power 5 |
| EZD 40 | YE04 | D-Power 40 |
| EZD1 | Y-810 | |
| EZD10 | Y-918J | |
| EZD18 | Y-115T1 | |
| EZD19 | Y-128T | |
| EZD20 | Y-117RS | |
| EZD21 | Y-118T1 | |
| EZD22 | Y-107T | |
| EZD30 | Y-924J | D-Power 1 |
| EZD41 | Y-504J | D-Power 24 |
| EZD5 | Y-924J | D-Power 1 |
| V94DX6M090AA | Y-924J | D-Power 1 |
| V95DD6M090AA | Y-741U | D-Power 20 |
| XM3412A342BA | Y-701J | D-Power 39 |
| XS4U6M090AB | Y-524J | D-Power 27 |

* only by car dealer



| MOTORCRAFT | → NGK Typ | V-LINE |
|-------------------|------------------|---------------|
| XS7U6M090BA | Y-525J | D-Power 35 |
| NISSAN | | |
| | → NGK Typ | V-LINE |
| 11065-02T00 | Y-955RS | |
| 11065-0W801 | CY58 | |
| 11065-10G00 | Y-705RS | |
| 11065-10T01 | Y-757RS | |
| 11065-16A00 | Y-117SS | |
| 11065-16A01 | Y144SS | |
| 11065-16A05 | Y-117RS | |
| 11065-16A06 | Y144RS | |
| 11065-16A10 | Y-117SS | |
| 11065-16A11 | Y144SS | |
| 11065-16A15 | Y-117RS | |
| 11065-16A16 | Y144RS | |
| 11065-29W00 | Y112RS1 | |
| 11065-2TB0A | Y-519J | D-Power 61 |
| 11065-31N00 | Y-712RS | |
| 11065-31W00 | Y-112T | |
| 11065-31W01 | Y-112T | |
| 11065-31W02 | Y-112TS | |
| 11065-34W00 | Y-112M1 | |
| 11065-37501 | Y803 | |
| 11065-37506 | Y-103 | |
| 11065-37507 | Y-103 | |
| 11065-43G01 | Y-707RS | |
| 11065-57J00 | CY52 | |
| 11065-5C900 | CY52 | |
| 11065-63G00 | Y-519J | D-Power 61 |
| 11065-63G00-GW | Y-707RS | |
| 11065-65N01 | CY58 | |
| 11065-7C000 | Y-530J | |
| 11065-89TA1 | Y-954M1 | |
| 11065-9C600 | Y-712RS | |
| 11065-AD200 | Y-519J | D-Power 61 |
| 11065-AD201 | Y-519J | D-Power 61 |
| 11065-AD220 | Y-519J | D-Power 61 |
| 11065-C0300 | Y177 | |
| 11065-C8600 | Y-755RS | |
| 11065-D2800 | Y-120RS | |
| 11065-DB000 | Y-522J | |
| 11065-G2400 | Y-712RS | |
| 11065-G2460 | Y-712RS | |
| 11065-G5501 | CY51 | |
| 11065-HC200 | Y-701J | D-Power 39 |
| 11065-HC251 | Y-721RS | |
| 11065-J2000 | Y-202 | |
| 11065-J5500 | Y2021 | |
| 11065-J5501 | Y-202-2 | |
| 11065-J5502 | Y-202-2 | |
| 11065-J5503 | Y2521 | |
| 11065-J5504 | Y2521 | |

| NISSAN | → NGK Typ | V-LINE |
|---------------|------------------|---------------|
| 11065-J5570 | Y-222T | |
| 11065-J6500 | Y272T | |
| 11065-K6700 | Y160 | |
| 11065-MA70A | Y-538J | |
| 11065-0W801 | CY58 | |
| 11065-Q4000 | Y-103-2A | |
| 11065-Q4001 | Y-112T1 | |
| 11065-T3400 | Y-177-1 | |
| 11065-T3401 | Y-177-1 | |
| 11065-T3470 | Y-181T | |
| 11065-T8200 | Y-112R1 | |
| 11065-T8201 | Y-162R1 | |
| 11065-T8202 | Y-112R1 | |
| 11065-T8203 | Y-162R1 | |
| 11065-T9000 | Y-272R1 | |
| 11065-T9001 | Y-272R1 | |
| 11065-V0700 | Y-204TS1 | |
| 11065-V0710 | Y-204TS1 | |
| 11065-V7202 | CX51 | |
| 11065-V7203 | CZ51 | |
| 11065-W2500 | Y-204RS | |
| 11065-W2510 | Y-204RS | |
| 11065-W3400 | Y-204SS | |
| 11065-W3410 | Y-204SS | |
| 11065-Y1400 | Y-103-1 | |
| 11065-Y1401 | Y-103-1 | |
| 11065-Y1402 | Y-103-2 | |
| 11065-Y1403 | Y-103-2 | |
| 11065-Y1404 | Y-103-2 | |
| 11065-Z5000 | Y-252 | |
| 82000-12099 | Y-517J | |
| RFJ5 18 601 | Y-701J | D-Power 39 |
| OPEL | | |
| | → NGK Typ | V-LINE |
| 09 111 145 | Y-910J | D-Power 3 |
| 09 118 201 | Y-748U | D-Power 14 |
| 09 196 669 | Y-523J | D-Power 37 |
| 1214032 | Y8003J | D-Power 62 |
| 1214034 | YE07 | |
| 1214300 | Y-810 | |
| 1214301 | Y-541J | D-Power 42 |
| 1214302 | Y-403-1 | |
| 1214303 | Y-403T | |
| 1214304 | Y-208T | |
| 1214305 | Y-523J | D-Power 37 |
| 1214308 | Y-306R | |
| 1214309 | Y-307R | |
| 1214310 | Y-719RS1 | |
| 1214311 | Y-710J | |
| 1214315 | Y-719RS1 | |
| 1214316 | CY03 | D-Power 8 |
| 1214319 | Y-924J | D-Power 1 |

* only by car dealer



| OPEL | → NGK Typ | V-LINE |
|-------------|------------------|---------------|
| 1214321 | Y-904M1 | |
| 1214323 | Y-904M1 | |
| 1214324 | Y-924J | D-Power 1 |
| 1214427 | Y-741U | D-Power 20 |
| 1214457 | Y-748U | D-Power 14 |
| 4403145 | Y-910J | D-Power 3 |
| 90 093 867 | Y-208T | |
| 90 093 897 | Y-208T | |
| 90 510 924 | Y-924J | D-Power 1 |
| 90 540 864 | Y-924J | D-Power 1 |
| 91 153 919 | Y-741U | D-Power 20 |
| 93 178 047 | Y8003J | D-Power 62 |
| 93 178 411 | YE07 | |
| 94 133 759 | Y-904M1 | |
| 94 175 158 | Y-904M1 | |
| 94 319 700 | Y-710J | |
| 94 402 303 | Y-307R | |
| 94 439 218 | Y-306R | |
| 94 481 972 | Y-719RS1 | |
| 97 044 037 | Y-719RS1 | |
| 97 080 554 | CY03 | D-Power 8 |
| 97 210 818 | Y-541J | D-Power 42 |
| 97 725 357 | Y-810 | |

PEUGEOT => siehe PSA

| PROTON | → NGK Typ | V-LINE |
|---------------|------------------|---------------|
| MD 197 511 | CY57 | D-Power 21 |

| PSA | → NGK Typ | V-LINE |
|------------|------------------|---------------|
| 5960 12 | YE04 | D-Power 40 |
| 5960 19 | YE04 | D-Power 40 |
| 5960 64 | Y1005J | D-Power 56 |
| 5960 65 | Y1005J | D-Power 56 |
| 5960 76 | YE12 | |
| 5960 77 | YE12 | |
| 5960 78 | YE05 | |
| 5960 79 | YE05 | |
| 5960 99 | YE08 | |
| 5960 A0 | YE08 | |
| 5960 E6 | Y8001AS | D-Power 58 |
| 5960 F4 | Y1005J | D-Power 56 |
| 5960 F9 | YE05 | |
| 5960 G6 | YE08 | |
| 5961 16 | Y-404 | |
| 5961 22 | Y-810 | |
| 5961 35 | Y-810 | |
| 5961 39 | Y-924J | D-Power 1 |
| 5961 53 | Y-208T | |
| 5961 54 | Y-208T | |
| 5961 58 | Y-208T | |
| 5962 03 | Y-503J | D-Power 10 |

| PSA | → NGK Typ | V-LINE |
|--------------|------------------|---------------|
| 5962 1Q | Y-738U | |
| 5962 2Y | Y-503J | D-Power 10 |
| 5962 2Z | Y-503J | D-Power 10 |
| 5962 3C | Y-504J | D-Power 24 |
| 5962 3H | Y-924J | D-Power 1 |
| 5962 5A | Y-739R | |
| 5962 J3 | Y-910J | D-Power 3 |
| 5962 T1 | Y-910J | D-Power 3 |
| 5962 T2 | Y-933J | D-Power 25 |
| 7932565882 | Y-810 | |
| 7932567718 | Y-208T | |
| 9150860280 | Y-924J | D-Power 1 |
| 9190861080 | Y-924J | D-Power 1 |
| 95493206 | Y-208T | |
| 95534788 | Y-208T | |
| 9637469980 | YE04 | |
| 9650100080 | YE05 | |
| 965254828000 | YE08 | |
| 9683195280 | Y8001AS | D-Power 58 |
| HG2621 | Y-810 | |

| RENAULT | → NGK Typ | V-LINE |
|----------------|------------------|---------------|
| 50 01 001 587 | Y-208T | |
| 77 00 100 558 | Y-506J | D-Power 7 |
| 77 00 100 586 | Y-740U | D-Power 22 |
| 77 00 100 635 | Y-516J | D-Power 12 |
| 77 00 105 290 | Y-927J | D-Power 19 |
| 77 00 111 323 | Y-732J | D-Power 4 |
| 77 00 662 199 | Y-208T | |
| 77 00 733 076 | Y-924J | D-Power 1 |
| 77 00 741 144 | Y-924J | D-Power 1 |
| 77 00 855 865 | Y-913J | D-Power 15 |
| 77 00 856 238 | Y-913J | D-Power 15 |
| 77 00 856 292 | Y-933J | D-Power 25 |
| 77 00 861 906 | Y-730U | D-Power 17 |
| 77 01 039 387 | Y-924J | D-Power 1 |
| 77 01 058 142 | Y-522J | |
| 77 01 349 475 | Y-924J | D-Power 1 |
| 82 00 012 099 | Y-517J | |
| 82 00 090 817 | Y-913J | D-Power 15 |
| 85 49 971 00 | Y-810 | |

| ROVER | → NGK Typ | V-LINE |
|--------------|------------------|---------------|
| ETC8847 | Y-729U | D-Power 34 |

| SAAB | → NGK Typ | V-LINE |
|-------------|------------------|---------------|
| 93 178 411 | YE07 | |

SEAT => siehe VW Group

SKODA => siehe VW Group

* only by car dealer

**SMART => siehe MERCEDES****SSANGYONG → NGK Typ V-LINE**

| | | |
|-----------------|---------|--|
| 667 159 00 01 | Y-537AS | |
| A 667 159 00 01 | Y-537AS | |

SUZUKI → NGK Typ V-LINE

| | | |
|-------------|--------|------------|
| 09900-F8Q01 | Y-516J | D-Power 12 |
| 09900-RF001 | Y-701J | D-Power 39 |

TOYOTA → NGK Typ V-LINE

| | | |
|-------------|---------|------------|
| 19850-0W010 | Y-542J | D-Power 45 |
| 19850-27010 | Y-531J | D-Power 44 |
| 19850-30010 | Y-531J | D-Power 44 |
| 19850-54030 | Y-118T1 | |
| 19850-54031 | Y-118T1 | |
| 19850-54050 | Y-118R | |
| 19850-54060 | Y-168R | |
| 19850-54090 | Y-715R | |
| 19850-56012 | Y-178T | |
| 19850-56021 | Y-128T | |
| 19850-56022 | Y-128T | |
| 19850-64010 | Y-146R | |
| 19850-64020 | Y-703R | |
| 19850-64031 | Y-532J | |
| 19850-64050 | Y-532J | |
| 19850-68010 | Y-147T | |
| 19850-68020 | Y-197T | |
| 19850-68030 | Y-128T | |
| 19850-68040 | Y-178T | |
| 19850-68060 | Y-197R | |

VOLVO → NGK Typ V-LINE

| | | |
|----------|------|------------|
| 31216248 | YE04 | D-Power 40 |
| 8631607 | YE12 | |

VW Group → NGK Typ V-LINE

| | | |
|---------------|---------|------------|
| 03L 963 319 A | Y1002AS | D-Power 57 |
| 059 963 319 A | Y-501U | D-Power 31 |
| 059 963 319 E | Y-609AS | D-Power 49 |
| 059 963 319 F | Y1002AS | D-Power 57 |
| 060 963 319 F | Y1002AS | D-Power 57 |
| N 019 1001 | Y-207T | |
| N 019 1002 | Y-207T | |
| N 019 1005 | Y-918J | |
| N 019 1006 | Y-918J | |
| N 101 401 04 | Y-732J | D-Power 4 |
| N 102 130 01 | Y-918J | D-Power 2 |
| N 102 130 02 | Y-918J | D-Power 2 |
| N 105 792 01 | Y-741U | D-Power 20 |
| N 105 798 02 | YE14 | D-Power 48 |
| N 105 798 05 | CZ304 | D-Power 55 |
| N 105 916 02 | Y-607AS | D-Power 50 |

VW Group → NGK Typ V-LINE

| | | |
|--------------|-------|------------|
| N 105 916 04 | CZ104 | D-Power 52 |
| N 105 916 08 | CZ104 | D-Power 52 |

YANMAR → NGK Typ V-LINE

| | | |
|--------------|--------|--|
| 1C1015-66250 | Y-715R | |
| 119660-77800 | Y-752M | |
| 119718-77800 | Y314 | |
| 124970-77800 | Y-116V | |
| 129155-77800 | Y-702R | |
| 129155-77801 | Y-702U | |
| 129331-77800 | Y-110V | |
| 129795-77800 | Y-103V | |

YUSIN → NGK Typ V-LINE

| | | |
|-------------|--------|--|
| 24018201000 | Y-122 | |
| 60518121011 | Y-112T | |

* only by car dealer

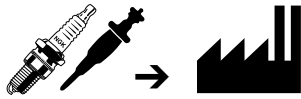

| | |
|---------------|---|
| A6 | AUTO UNION |
| A7 | AUTO UNION, GLAS, WARTBURG |
| AB6 | AUTO UNION |
| AB7 | AUTO UNION, GLAS, WARTBURG |
| AP6FS | FORD |
| APR5FS | FORD |
| APR6FS | FORD |
| B5ES | VW |
| B5HS | MERCEDES-BENZ, VW |
| B6EFS | JAGUAR |
| B6ES | GLAS, PORSCHE, VW |
| B6HS | AUTO UNION, BARKAS, BORGWARD, CITROËN, FORD, OPEL, RENAULT, TRABANT, VW |
| B6S | OPEL, VOLVO |
| B7ECS | TVR |
| B7ES | ALFA ROMEO, AUDI, BMW, FIAT, NSU |
| B7HS | BMW, BORGWARD, FIAT, FORD, PORSCHE, RENAULT |
| B7HVX | ALPINE |
| B8ECS | CATERHAM |
| B8EFS | RENAULT |
| B8EG | RENAULT |
| B8EGV | PORSCHE |
| B8ES | ALFA ROMEO, BMW, JAGUAR, NSU, PORSCHE, TALBOT |
| B8EVX | ALPINE, RENAULT |
| B8HS | BMW |
| B9EG | RENAULT |



| | |
|--------------------|--|
| B9EGP | ALPINE |
| B9ES | FIAT |
| B9EVX | PORSCHE |
| B9HVX | BMW |
| BCP5E | CITROËN, DAEWOO, MERCEDES-BENZ, PEUGEOT, RENAULT, SAAB, SSANGYONG |
| BCP5ES | CITROËN, DAEWOO, MERCEDES-BENZ, PEUGEOT, RENAULT, SAAB, SSANGYONG |
| BCP5ES-11 | NISSAN |
| BCP5EVX | SAAB |
| BCP6E | ALFA ROMEO, CITROËN, MERCEDES- BENZ, NISSAN, PEUGEOT, PUCH, RENAULT, ROVER |
| BCP6ES | ALFA ROMEO, CITROËN, MERCEDES- BENZ, NISSAN, PEUGEOT, PUCH, RENAULT, ROVER |
| BCP6ES-11 | NISSAN |
| BCP6ET | CITROËN, PEUGEOT, RENAULT |
| BCP6EVX | SAAB |
| BCP7ES | ALFA ROMEO, SEAT |
| BCP7ET | AUDI, SEAT, VW |
| BCP7EVX | SAAB, VOLVO |
| BCPR5E | CITROËN, PEUGEOT, RENAULT, SKODA |
| BCPR5EIX-11 | TOYOTA |
| BCPR5EP-11 | TOYOTA |
| BCPR5EP-8 | TOYOTA |
| BCPR5ES | CITROËN, PEUGEOT, RENAULT, SKODA |
| BCPR5ES-11 | NISSAN |
| BCPR5EY | TOYOTA |

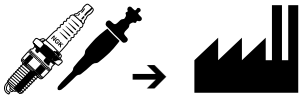

| | |
|---------------------|---|
| BCPR6E | ASTON MARTIN, AUTOBIANCHI, CHEVROLET, CHRYSLER, CITROËN, DAIMLER, FIAT, FORD, FSO, JAGUAR, LANCIA, MAZDA, MORGAN, NISSAN, PEUGEOT, PONTIAC, RENAULT, ROVER, SAAB, SKODA, TVR, VOLVO |
| BCPR6E-11 | ACURA, FORD, FORD USA, HONDA, LADA, MAZDA, MITSUBISHI, NISSAN, ROVER, SAAB, SUBARU |
| BCPR6EP-11 | TOYOTA |
| BCPR6EP-13 | TOYOTA |
| BCPR6EPN-8 | TOYOTA |
| BCPR6ES | ASTON MARTIN, AUTOBIANCHI, CHEVROLET, CHRYSLER, CITROËN, DAIMLER, FIAT, FORD, FSO, JAGUAR, LANCIA, MAZDA, MORGAN, NISSAN, PEUGEOT, PONTIAC, RENAULT, ROVER, SAAB, SKODA, TVR, VOLVO |
| BCPR6ES-11 | FORD, FORD USA, LADA, MITSUBISHI, NISSAN, SAAB, SUBARU |
| BCPR6ET | CITROËN, FIAT, LANCIA, PEUGEOT, VOLVO |
| BCPR6EY | TOYOTA |
| BCPR6EY-11 | HONDA, TOYOTA |
| BCPR6EY-N-11 | HONDA |
| BCPR7E | FIAT |
| BCPR7EIX | CITROËN, FIAT, FORD, PEUGEOT, SAAB |
| BCPR7ES | ASTON MARTIN, CATERHAM, CITROËN, FIAT, FORD, LANCIA, PEUGEOT, SAAB, VOLVO |
| BCPR7ES-11 | FORD, SAAB |
| BCPR7ET | FIAT, PORSCHE |
| BCPR9ES-11 | FORD |
| BCR8ES | FORD |
| BCRE527Y | TOYOTA |



| | |
|--------------------|--|
| BK5ESZ | RENAULT |
| BK6E | KIA, MITSUBISHI, VAUXHALL |
| BK6E-11 | KIA, MITSUBISHI |
| BKR5E | KIA, MAZDA, NISSAN, VW |
| BKR5E-11 | CHEVROLET, DAEWOO, DAIHATSU, HYUNDAI, INFINITI, KIA, MAZDA, MITSUBISHI, NISSAN, SUBARU |
| BKR5EIX-11 | VAUXHALL |
| BKR5EK | CHEVROLET, CITROËN, DAEWOO, FIAT, LANCIA, NISSAN, OPEL, PEUGEOT, RENAULT, SAAB, VAUXHALL |
| BKR5EKB-11 | TOYOTA |
| BKR5EKC | DAIHATSU |
| BKR5EKU | MERCEDES-BENZ, TVR, VW |
| BKR5EKUP | FORD, MERCEDES-BENZ, SEAT, VW |
| BKR5EP-11 | LEXUS, TOYOTA |
| BKR5EQUPA | OPEL, SAAB |
| BKR5ES | KIA |
| BKR5ES-11 | HYUNDAI, INFINITI, KIA |
| BKR5EVX | BENTLEY, RENAULT, VW |
| BKR5EVX-11 | OPEL |
| BKR5EVXA-13 | JAGUAR |
| BKR5EY | NISSAN |
| BKR5EY-11 | NISSAN |
| BKR5EYA | TOYOTA |
| BKR5EYA-11 | TOYOTA |
| BKR5EZ | CITROËN, FIAT, LANCIA, PEUGEOT, RENAULT |
| BKR6E | AUDI, AUSTIN, CATERHAM, CHRYSLER, CITROËN, DACIA, FIAT, HYUNDAI, KIA, |

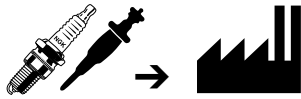

| | |
|--------------------|---|
| | LADA, LAND ROVER, MAZDA, MERCEDES-BENZ, NISSAN, OPEL, PANTHER, PEUGEOT, PORSCHE, RENAULT, ROVER, SKODA, SUZUKI, VOLVO, VW |
| BKR6E-11 | CHEVROLET, DAEWOO, DAIHATSU, HONDA, ISUZU, KIA, MAZDA, MITSUBISHI, NISSAN, PEUGEOT, PROTON, ROVER, SUBARU, SUZUKI |
| BKR6EIX | RENAULT |
| BKR6EK | ALPINA, BERTONE, BMW, CITROËN, DAEWOO, FIAT, LANCIA, MERCEDES- BENZ, OPEL, PEUGEOT, PORSCHE, SAAB, VAUXHALL, WIESMANN |
| BKR6EKB-11 | TOYOTA |
| BKR6EKC | DAIHATSU, FIAT, LANCIA, LOTUS |
| BKR6EKE | SMART |
| BKR6EKPA | ALFA ROMEO |
| BKR6EKPB-11 | LEXUS, TOYOTA |
| BKR6EKUB | AUDI, RENAULT, SKODA, VOLVO, VW |
| BKR6EKUE | VW |
| BKR6E-N-11 | HONDA |
| BKR6EP-11 | LEXUS, TOYOTA |
| BKR6EP-13 | TOYOTA |
| BKR6EP-8 | DAIHATSU, LEXUS, TOYOTA |
| BKR6EQU | BMW |
| BKR6EQUA | AUDI, VW |
| BKR6EQUP | ALPINA, AUDI, BENTLEY, BMW, LAND ROVER, MINI, MORGAN, PORSCHE, ROLLS-ROYCE, VOLVO |
| BKR6ES | AUSTIN, CATERHAM, CITROËN, FIAT, HYUNDAI, KIA, MERCEDES-BENZ, PEUGEOT, PORSCHE, RENAULT, ROVER, SKODA, VOLVO |



| | |
|--------------------|---|
| BKR6ES-11 | KIA, NISSAN |
| BKR6ETA-10 | SEAT, SKODA, VW |
| BKR6EVX | SUBARU, VOLVO |
| BKR6EVX-11 | FORD, MAZDA |
| BKR6EVXA-11 | JAGUAR |
| BKR6EVXA-13 | JAGUAR |
| BKR6EY | NISSAN |
| BKR6EY-11 | DAIHATSU |
| BKR6EYA | TOYOTA |
| BKR6EYA-11 | TOYOTA |
| BKR6EZ | CITROËN, DACIA, FIAT, LANCIA, NISSAN, PEUGEOT, RENAULT |
| BKR6EZB | MERCEDES-BENZ |
| BKR7E | FIAT, JAGUAR, LOTUS, ROVER, VOLVO |
| BKR7EIX | PORSCHE |
| BKR7EKC | PORSCHE |
| BKR7E-N-11 | HONDA |
| BKR7EQUP | PORSCHE |
| BKR7ES-11 | SAAB |
| BKR7ESC-11 | SAAB |
| BKR7EVX | VOLVO |
| BKR7EVX-11 | FORD |
| BKR8EIX | FIAT, FORD, JAGUAR, LOTUS, PORSCHE, ROVER, SAAB, VOLVO |
| BKUR5ET | MERCEDES-BENZ, VW |
| BKUR5ET-10 | AUDI, MERCEDES-BENZ, SEAT, SKODA, VW |
| BKUR6EK | DAIHATSU, PIAGGIO |

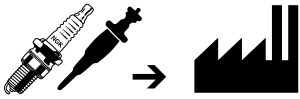

| | |
|--------------------|--|
| BKUR6ET | FIAT, LANCIA, SEAT, VW |
| BKUR6ET-10 | AUDI, MERCEDES-BENZ, SEAT, SKODA, VW |
| BKUR6ETB | ALFA ROMEO, CHEVROLET, LANCIA |
| BKUR6ETB-10 | DAIHATSU |
| BKUR7ET | ALPINE, AUDI, PEUGEOT, RENAULT, SEAT, VW |
| BP4EY | TOYOTA |
| BP5E | BMW, DAIMLER, HYUNDAI, ISUZU, JAGUAR, LAND ROVER, MG, MITSUBISHI, NISSAN, PEUGEOT, RENAULT, TRIUMPH, VW |
| BP5EFS | MERCEDES-BENZ, ROVER |
| BP5ES | BMW, DAIMLER, HYUNDAI, ISUZU, JAGUAR, LAND ROVER, MG, MITSUBISHI, NISSAN, PEUGEOT, RENAULT, TRIUMPH, VW |
| BP5ESA | VW |
| BP5ESZ | ARO, RENAULT |
| BP5ET | OPEL, SEAT, VW |
| BP5EVX | PORSCHE |
| BP5EY | TOYOTA |
| BP5HS | LAND ROVER, MG, ROVER |
| BP6E | ALFA ROMEO, ASTON MARTIN, AUDI, AUSTIN, AUTOBIANCHI, BEDFORD, BMW, BOND, CITROËN, FIAT, FORD, FSO, GLAS, INNOCENTI, ISUZU, LADA, LANCIA, LAND ROVER, MASERATI, MERCEDES-BENZ, MG, MITSUBISHI, MORGAN, NISSAN, OPEL, PEUGEOT, RENAULT, ROVER, SAAB, SEAT, SUBARU, TALBOT, TRABANT, TRIUMPH, VAUXHALL, VOLVO, VW, WARTBURG, ZASTAVA, ZAZ |



| | |
|-----------------|--|
| BP6EF | ALPINE, AUSTIN, CITROËN, LAND ROVER, MERCEDES-BENZ, PEUGEOT, PUCH, RENAULT, ROVER, TALBOT, TRIUMPH, VOLVO |
| BP6EFS | ALPINE, AUSTIN, CITROËN, LAND ROVER, MERCEDES-BENZ, PEUGEOT, PUCH, RENAULT, ROVER, TALBOT, TRIUMPH, VOLVO |
| BP6ES | ALFA ROMEO, ASTON MARTIN, AUDI, AUSTIN, AUTOBIANCHI, BEDFORD, BMW, BOND, CITROËN, FIAT, FORD, FSO, GLAS, INNOCENTI, ISUZU, LADA, LANCIA, LAND ROVER, MASERATI, MERCEDES-BENZ, MG, MITSUBISHI, MORGAN, NISSAN, OPEL, PEUGEOT, RENAULT, ROVER, SAAB, SEAT, SUBARU, TALBOT, TRABANT, TRIUMPH, VAUXHALL, VOLVO, VW, WARTBURG, ZASTAVA, ZAZ |
| BP6ES-11 | HYUNDAI |
| BP6ESZ | AUDI, RENAULT, VW |
| BP6ET | ALFA ROMEO, FIAT, LANCIA, PEUGEOT, PORSCHE, SEAT |
| BP6EY-11 | HYUNDAI |
| BP6FS | VAUXHALL |
| BP6H | CITROËN, DACIA, DAF, FORD, MERCEDES-BENZ, OPEL, PORSCHE, RENAULT, SEAT, SKODA, TALBOT, TRABANT, VOLVO, WARTBURG |
| BP6HS | CITROËN, DACIA, DAF, FORD, MERCEDES-BENZ, OPEL, PORSCHE, RENAULT, SEAT, SKODA, TALBOT, TRABANT, VOLVO, WARTBURG |
| BP7EFS | CITROËN, PEUGEOT, RENAULT, VOLVO |
| BP7EFVX | ALPINE, MERCEDES-BENZ, RENAULT |
| BP7ES | ALFA ROMEO, AUDI, BMW, DAIMLER, FERRARI, FIAT, FORD, JAGUAR, MERCEDES-BENZ, MOSKVICH, PININFARINA, PORSCHE, RENAULT, SAAB, SEAT, VAUXHALL, VW |

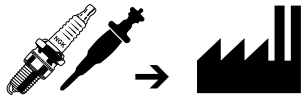

| | |
|------------------|---|
| BP7EVX | AUDI |
| BP7HS | CITROËN, FORD, FSO, PORSCHE, VOLVO |
| BP8ES | ALFA ROMEO, FIAT, MASERATI |
| BP8EVX | FERRARI, MERCEDES-BENZ, MOSKVICH, PORSCHE |
| BPM7F | FORD |
| BPR4EY | DAIHATSU, TOYOTA |
| BPR5E | ASIA MOTORS, BEDFORD, DAIHATSU, FIAT, HONDA, MARUTI, MAZDA, MITSUBISHI, NISSAN, OPEL, PROTON, RENAULT, SEAT, SUZUKI, TOYOTA, TRIUMPH, VAUXHALL, ZASTAVA |
| BPR5E-11 | NISSAN |
| BPR5EA-L | DAIHATSU, TOYOTA |
| BPR5EKU | AUDI, VW |
| BPR5EP-11 | TOYOTA |
| BPR5ES | ASIA MOTORS, BEDFORD, DAIHATSU, FIAT, HONDA, MARUTI, MAZDA, MITSUBISHI, NISSAN, OPEL, PROTON, RENAULT, SEAT, SUZUKI, TOYOTA, TRIUMPH, VAUXHALL, ZASTAVA |
| BPR5ES-11 | CHRYSLER, HYUNDAI, KIA, MAZDA, MITSUBISHI, NISSAN |
| BPR5EY | DAIHATSU, HONDA, SUZUKI, TOYOTA, VW |
| BPR5EY-11 | CHEVROLET, DAEWOO, DAIHATSU, HONDA, KIA, TOYOTA, VW |
| BPR5FS-11 | AC |
| BPR6E | ALFA ROMEO, AUSTIN, AUTOBIANCHI, BEDFORD, BMW, CHEVROLET, CHRYSLER, DAEWOO, DAIHATSU, FIAT, FORD, HONDA, INNOCENTI, ISUZU, KIA, LADA, LANCIA, LAND ROVER, LOTUS, MAZDA, MERCEDES-BENZ, MG, MITSUBISHI, MORGAN, NISSAN, OPEL, PANTHER, PININFARINA, PORSCHE, PROTON, RENAULT, ROVER, SEAT, |



| | |
|------------------|---|
| | SUBARU, SUZUKI, TALBOT, TVR, VAUXHALL, VOLVO, ZASTAVA |
| BPR6EF | FORD, LANCIA, RENAULT, VOLVO |
| BPR6EFS | FORD, LANCIA, RENAULT, VOLVO |
| BPR6EKN | DAIHATSU, LOTUS |
| BPR6ES | ALFA ROMEO, AUSTIN, AUTOBIANCHI, BEDFORD, BMW, CHEVROLET, CHRYSLER, DAEWOO, DAIHATSU, FIAT, FORD, HONDA, INNOCENTI, ISUZU, KIA, LADA, LANCIA, LAND ROVER, LOTUS, MAZDA, MERCEDES-BENZ, MG, MITSUBISHI, MORGAN, NISSAN, OPEL, PANTHER, PININFARINA, PORSCHE, PROTON, RENAULT, ROVER, SEAT, SUBARU, SUZUKI, TALBOT, TVR, VAUXHALL, VOLVO, ZASTAVA |
| BPR6ES-11 | HYUNDAI, ISUZU, KIA, MAZDA, MITSUBISHI, NISSAN, OPEL, SUBARU |
| BPR6EY | ASTON MARTIN, DAIHATSU, HONDA, TOYOTA |
| BPR6EY-11 | DAIHATSU, HONDA, TOYOTA |
| BPR6FS | BEDFORD, PANTHER, VAUXHALL |
| BPR6H | BEDFORD, FORD, OPEL |
| BPR6HS | BEDFORD, FORD, OPEL |
| BPR7E | ALFA ROMEO, AUSTIN, AUTOBIANCHI, FIAT, FORD, LANCIA, LOTUS, MITSUBISHI, PININFARINA, PORSCHE, RENAULT, SUBARU, TALBOT, VOLVO |
| BPR7ES | ALFA ROMEO, AUSTIN, AUTOBIANCHI, FIAT, FORD, LANCIA, LOTUS, MITSUBISHI, PININFARINA, PORSCHE, RENAULT, SUBARU, TALBOT, VOLVO |
| BPR7ES-11 | MITSUBISHI |
| BPR7EY | ASTON MARTIN |
| BPR7HIX | BEDFORD, CITROËN, DACIA, DAF, FORD, MERCEDES-BENZ, OPEL, PORSCHE, RENAULT, SEAT, SKODA, TALBOT, TRABANT, VOLVO, WARTBURG |

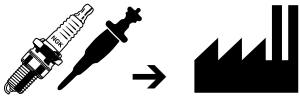

| | |
|-----------------|--|
| BPR7HS | FIAT, FORD, PORSCHE |
| BPR8EIX | ALFA ROMEO, AUDI, AUSTIN, AUTOBIANCHI, BMW, DAIMLER, FERRARI, FIAT, FORD, JAGUAR, LANCIA, LOTUS, MERCEDES-BENZ, MITSUBISHI, MOSKVICH, PININFARINA, PORSCHE, RENAULT, SAAB, SEAT, SUBARU, TALBOT, VOLVO, VW |
| BPR8EVX | PORSCHE |
| BPR8HIX | FIAT, FORD, PORSCHE |
| BPR9EIX | ALFA ROMEO, FERRARI, FIAT, MASERATI, MERCEDES-BENZ, MOSKVICH, PORSCHE |
| BPR9EVX | PORSCHE |
| BR10EIX | FIAT, PORSCHE |
| BR10ET | MAZDA |
| BR6EF | DAIMLER |
| BR6ES | HONDA |
| BR6ES-11 | NISSAN |
| BR6S | OPEL |
| BR7EF | DAIMLER, JAGUAR, PEUGEOT |
| BR7EFS | DAIMLER, JAGUAR |
| BR7EIX | HONDA, NISSAN |
| BR7ES | MITSUBISHI, PEUGEOT |
| BR7HIX | AUTO UNION, BARKAS, BORGWARD, CITROËN, FORD, OPEL, RENAULT, TRABANT, VW |
| BR8EIX | ALFA ROMEO, AUDI, AUTOBIANCHI, BMW, FIAT, LANCIA, MITSUBISHI, NSU, PEUGEOT, TALBOT |
| BR8ES | AUTOBIANCHI, FIAT, LANCIA |
| BR8ET | MAZDA |
| BR8EVX | PORSCHE |



| | |
|------------------|---|
| BR8HIX | ALPINE, BMW, BORGWARD, FIAT, FORD, PORSCHE, RENAULT |
| BR9EIX | ALFA ROMEO, ALPINE, BMW, JAGUAR, MAZDA, NSU, PORSCHE, RENAULT |
| BU6EFSZ | ALPINE |
| BUR5ET | AUDI, SEAT, VW |
| BUR5ET-10 | AUDI, SAAB, SEAT, VW |
| BUR6EA-11 | HYUNDAI, MITSUBISHI |
| BUR6EFSZ | AUDI |
| BUR6ET | AUDI, FIAT, LANCIA, SEAT, SKODA, VW |
| BUR7EA-11 | MITSUBISHI |
| BUR9EQ | MAZDA |
| BUR9EQP | MAZDA |
| C8E | FERRARI |
| CR7EKC | ALFA ROMEO |
| CR8EVX | FERRARI |
| CX51 | NISSAN |
| CY03 | OPEL |
| CY51 | NISSAN |
| CY52 | NISSAN |
| CY55 | MITSUBISHI |
| CY57 | HYUNDAI, MITSUBISHI |
| CY58 | FORD, NISSAN |
| CZ104 | AUDI, SEAT, SKODA, VW |
| CZ106 | MERCEDES-BENZ |
| CZ303 | MERCEDES-BENZ |
| CZ304 | AUDI, SEAT, SKODA, VW |
| CZ51 | NISSAN |

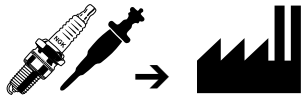

| | |
|--------------------|--|
| CZ71 | NISSAN |
| D7EA | BMW |
| D8EA | LANCIA |
| D8EVX | BMW, FERRARI |
| DCPR7E | SUZUKI |
| DCPR7E-N | FIAT, LANCIA |
| DCPR7E-N-10 | FIAT |
| DCPR7EVX | SUZUKI |
| DCPR8E | CHEVROLET, FIAT, LANCIA, TVR |
| DCPR8EKC | FIAT |
| DCPR8EKP | BMW, WIESMANN |
| DCPR8E-N | FIAT |
| DCPR9E | LANCIA, MASERATI |
| DCPR9EVX | FERRARI |
| DILFR5A11 | MITSUBISHI |
| DILKR8B6 | MITSUBISHI |
| D-Power 1 | ALFA ROMEO, ARO, BMW, CHRYSLER, CITROËN, FIAT, FORD, FSO, HYUNDAI, INNOCENTI, JEEP, LADA, LANCIA, LAND ROVER, MERCEDES-BENZ, OPEL, PEUGEOT, RENAULT, ROVER, SEAT, SUZUKI, TALBOT, VAUXHALL |
| D-Power 2 | AUDI, FSO, SEAT, SKODA, VOLVO, VW |
| D-Power 3 | CITROËN, FIAT, FORD, MAZDA, OPEL, PEUGEOT, RENAULT, ROVER, VAUXHALL |
| D-Power 4 | AUDI, DACIA, FORD, MITSUBISHI, NISSAN, OPEL, RENAULT, SEAT, SKODA, SUZUKI, VAUXHALL, VOLVO, VW |
| D-Power 5 | FORD |
| D-Power 6 | DAEWOO, MERCEDES-BENZ, SSANGYONG |



| | |
|-------------------|--|
| D-Power 7 | OPEL, RENAULT, VAUXHALL |
| D-Power 8 | OPEL |
| D-Power 9 | CITROËN, PEUGEOT, ROVER |
| D-Power 1 | ALFA ROMEO, ARO, BMW, CHRYSLER, CITROËN, FIAT, FORD, FSO, HYUNDAI, INNOCENTI, JEEP, LADA, LANCIA, MERCEDES-BENZ, OPEL, PEUGEOT, RENAULT, ROVER, SEAT, SUZUKI, TALBOT, VAUXHALL |
| D-Power 10 | CITROËN, FIAT, NISSAN, PEUGEOT, RENAULT, ROVER |
| D-Power 11 | CHRYSLER, JEEP, MERCEDES-BENZ, SSANGYONG |
| D-Power 12 | RENAULT |
| D-Power 13 | MITSUBISHI |
| D-Power 14 | KIA, OPEL, SAAB, VAUXHALL |
| D-Power 15 | RENAULT, VOLVO |
| D-Power 16 | MERCEDES-BENZ |
| D-Power 17 | HONDA, LAND ROVER, RENAULT, ROVER |
| D-Power 18 | DACIA, MITSUBISHI, NISSAN, OPEL, RENAULT, SUZUKI, VOLVO |
| D-Power 19 | RENAULT |
| D-Power 2 | AUDI, FSO, SEAT, SKODA, VOLVO, VW |
| D-Power 20 | AUDI, CHRYSLER, FORD, JEEP, OPEL, SEAT, SKODA, VAUXHALL, VW |
| D-Power 21 | HYUNDAI, MITSUBISHI |
| D-Power 22 | HONDA, RENAULT, VOLVO |
| D-Power 23 | FIAT, OPEL |
| D-Power 24 | CITROËN, FIAT, LANCIA, PEUGEOT, SUZUKI |
| D-Power 25 | ARO, MITSUBISHI, RENAULT, VOLVO |
| D-Power 26 | ALFA ROMEO, FIAT, LANCIA |

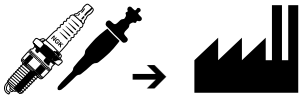

| | |
|-------------------|---|
| D-Power 27 | FORD |
| D-Power 28 | ISUZU, OPEL, VAUXHALL |
| D-Power 29 | FIAT, LANCIA |
| D-Power 3 | FORD, MAZDA |
| D-Power 30 | MERCEDES-BENZ |
| D-Power 31 | AUDI, SKODA, VW |
| D-Power 32 | BMW, LAND ROVER, MG, ROVER |
| D-Power 33 | CITROËN, PEUGEOT, ROVER |
| D-Power 34 | LAND ROVER |
| D-Power 35 | FORD, JAGUAR |
| D-Power 36 | ALFA ROMEO, FIAT, LANCIA, OPEL, SUZUKI, VAUXHALL |
| D-Power 37 | OPEL, VAUXHALL |
| D-Power 38 | MERCEDES-BENZ |
| D-Power 39 | FORD, KIA, MAZDA, SUZUKI |
| D-Power 40 | CITROËN, FORD, MAZDA, PEUGEOT, SUZUKI, VOLVO |
| D-Power 41 | DAEWOO, MERCEDES-BENZ |
| D-Power 42 | HONDA, OPEL, VAUXHALL |
| D-Power 43 | FIAT |
| D-Power 44 | TOYOTA |
| D-Power 45 | TOYOTA |
| D-Power 46 | FIAT, SMART |
| D-Power 47 | BMW |
| D-Power 48 | AUDI, MITSUBISHI, SEAT, SKODA, VW |
| D-Power 49 | AUDI, VW |
| D-Power 5 | FORD |
| D-Power 50 | AUDI, SEAT, SKODA, VW |



| | |
|-------------------|---|
| D-Power 51 | CHRYSLER, MERCEDES-BENZ |
| D-Power 52 | AUDI, SEAT, SKODA, VW |
| D-Power 53 | MERCEDES-BENZ |
| D-Power 54 | MERCEDES-BENZ |
| D-Power 55 | AUDI, SEAT, SKODA, VW |
| D-Power 56 | CITROËN, FIAT, FORD, LANCIA, PEUGEOT |
| D-Power 57 | AUDI, SKODA, VW |
| D-Power 58 | CITROËN, PEUGEOT |
| D-Power 59 | MITSUBISHI |
| D-Power 6 | DAEWOO, MERCEDES-BENZ, SSANGYONG |
| D-Power 60 | OPEL |
| D-Power 9 | CITROËN, PEUGEOT, ROVER |
| FR4 | JEEP |
| FR45 | DODGE, PLYMOUTH |
| FR5 | DODGE, PLYMOUTH |
| FR5-1 | CHRYSLER, JEEP |
| FR5CP | ALFA ROMEO |
| FR6EI | MITSUBISHI |
| GR4 | CHRYSLER, JEEP |
| GR4IX | CHRYSLER |
| GR5IX | CHRYSLER, JEEP |
| HB6AIX-11P | TOYOTA |
| HB6BIX-11P | MITSUBISHI, TOYOTA |
| IFR5E-11 | MAZDA, SUZUKI |
| IFR5E13 | MAZDA |
| IFR5G-11K | HONDA |

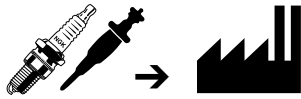

| | |
|--------------------|--------------------------------|
| IFR5J-11 | SUZUKI |
| IFR5N10 | JAGUAR, LAND ROVER |
| IFR5T11 | TOYOTA |
| IFR5T-8N | TOYOTA |
| IFR6B11 | VOLVO |
| IFR6D10 | CHRYSLER, MERCEDES-BENZ |
| IFR6E11 | CHEVROLET, MAZDA, SUZUKI |
| IFR6J-11 | DAIHATSU, FIAT, SUBARU, SUZUKI |
| IFR6Q-G | MAYBACH, MERCEDES-BENZ |
| IFR6T-11 | LEXUS, TOYOTA |
| IFR7G-11KS | HONDA |
| IGR6A-11 | MITSUBISHI |
| IGR7A-G | MITSUBISHI |
| IKR6G-11 | SUZUKI |
| IKR7D | DAIHATSU |
| IKR9F8 | ALFA ROMEO, FIAT, LANCIA |
| ILFR5B-11 | HYUNDAI, KIA |
| ILFR6A | MERCEDES-BENZ |
| ILFR6B | SUBARU, VOLVO |
| ILFR6J-11K | HONDA |
| ILFR7H | MITSUBISHI |
| ILKAR7B-11 | TOYOTA |
| ILTR5A-13G | FORD, MAZDA |
| ILTR5D | OPEL |
| ILTR6A-13G | FORD, MAZDA |
| ILZFR6C-11K | MITSUBISHI |
| ILZFR6C-K | MITSUBISHI, SMART |



| | |
|---------------------|---|
| ILZFR6D11 | BMW |
| ILZKBR7A-8G | MINI |
| ILZKR7A | AUDI, VW |
| ILZKR7B-11GS | HONDA |
| ITR5F-13 | MAZDA |
| ITR6F-13 | FORD, MAZDA, VOLVO |
| IZFR5B | MITSUBISHI |
| IZFR6B | MITSUBISHI, VOLVO |
| IZFR6H-11 | BMW |
| IZFR6K-11 | HONDA |
| IZFR6K-11S | HONDA |
| IZKR7B | AUDI, PORSCHE, VW |
| LFR4AP-11 | RENAULT |
| LFR5A-11 | NISSAN |
| LFR5AIX-11 | NISSAN |
| LFR5AP-11 | NISSAN |
| LFR5B | CITROËN, FIAT, PEUGEOT |
| LFR6B | CITROËN, PEUGEOT |
| LFR6C-11 | CITROËN, DAIHATSU, MITSUBISHI, PEUGEOT, SMART, TOYOTA |
| LFR6D | VOLVO |
| LKR7B-9 | SMART |
| LKR8A | SMART |
| LKR8AP | BMW |
| LPG 1 | ALFA ROMEO, ALPINA, AUDI, AUSTIN, BENTLEY, BERTONE, BMW, CATERHAM, CHEVROLET, CHRYSLER, CITROËN, DACIA, DAEWOO, DAIHATSU, FIAT, FORD, HONDA, HYUNDAI, INFINITI, ISUZU, JAGUAR, KIA, LADA, LANCIA, |



| | |
|--------------|--|
| | LAND ROVER, LEXUS, LOTUS, MAZDA, MERCEDES-BENZ, MINI, MITSUBISHI, MORGAN, NISSAN, OPEL, PANTHER, PEUGEOT, PIAGGIO, PORSCHE, PROTON, RENAULT, ROLLS-ROYCE, ROVER, SAAB, SEAT, SKODA, SUBARU, SUZUKI, TOYOTA, VAUXHALL, VOLVO, VW, WIESMANN |
| LPG 2 | ALFA ROMEO, ARO, ASIA MOTORS, ASTON MARTIN, AUDI, AUSTIN, AUTOBIANCHI, BEDFORD, BMW, BOND, CHEVROLET, CHRYSLER, CITROËN, DAEWOO, DAIHATSU, DAIMLER, FIAT, FORD, FSO, GLAS, HONDA, HYUNDAI, INNOCENTI, ISUZU, JAGUAR, KIA, LADA, LANCIA, LAND ROVER, LOTUS, MARUTI, MASERATI, MAZDA, MERCEDES-BENZ, MG, MITSUBISHI, MORGAN, NISSAN, OPEL, PANTHER, PEUGEOT, PININFARINA, PORSCHE, PROTON, RENAULT, ROVER, SAAB, SEAT, SKODA, SUBARU, SUZUKI, TALBOT, TOYOTA, TRABANT, TRIUMPH, TVR, VAUXHALL, VOLVO, VW, WARTBURG, ZASTAVA, ZAZ |
| LPG 3 | ACURA, ALFA ROMEO, ASTON MARTIN, AUTOBIANCHI, CHEVROLET, CHRYSLER, CITROËN, DAEWOO, DAIMLER, FIAT, FORD, FORD USA, FSO, HONDA, JAGUAR, LADA, LANCIA, MAZDA, MERCEDES-BENZ, MITSUBISHI, MORGAN, NISSAN, PEUGEOT, PONTIAC, PUCH, RENAULT, ROVER, SAAB, SKODA, SSANGYONG, SUBARU, TOYOTA, TVR, VOLVO |
| LPG 4 | CHEVROLET, FORD, HUMMER, MAZDA, MORGAN |
| LPG 5 | ALPINE, ASTON MARTIN, AUSTIN, BUICK, CADILLAC, CHEVROLET, CITROËN, DE LOREAN, FORD, FORD USA, HUMMER, JAGUAR, LANCIA, LAND ROVER, MAZDA, MERCEDES-BENZ, PEUGEOT, PONTIAC, PUCH, RENAULT, ROVER, TALBOT, TRIUMPH, VOLVO |
| LPG 6 | AUDI, BMW, CHRYSLER, DODGE, FORD, FORD USA, HONDA, HYUNDAI, JEEP, KIA, MAZDA, OPEL, ROVER, SEAT, SKODA, VAUXHALL, VW |



| | |
|------------------|--|
| LPG 7 | CITROËN, FIAT, INFINITI, LANCIA, NISSAN, PEUGEOT, RENAULT, SUBARU, VOLVO |
| LPG 8 | CHEVROLET, FIAT, FORD, LANCIA, SUZUKI, TVR |
| LTR6B-10T | FIAT, OPEL, VAUXHALL |
| LZFR6AI | mitsubishi |
| LZKAR7A | CITROËN, NISSAN, PEUGEOT, RENAULT |
| LZKAR7B | RENAULT |
| LZTR4A-11 | CHRYSLER, JEEP |
| LZTR5A-13 | CHRYSLER |
| PFR5B | AUDI |
| PFR5B-11 | HYUNDAI, INFINITI, SUBARU |
| PFR5G-11 | DODGE, HONDA, INFINITI, OPEL, VAUXHALL |
| PFR5G-11E | JAGUAR |
| PFR5G-13E | JAGUAR |
| PFR5J-11 | HYUNDAI, MITSUBISHI |
| PFR5N-11 | HYUNDAI, KIA |
| PFR5R-11 | MERCEDES-BENZ |
| PFR6A-11 | NISSAN |
| PFR6B | ALFA ROMEO, AUDI, HYUNDAI, INFINITI, LANCIA, SUBARU, VOLVO |
| PFR6B-11 | CHRYSLER, FORD, INFINITI, ISUZU, NISSAN, SUBARU |
| PFR6B-9 | NISSAN |
| PFR6D10G | SAAB |
| PFR6E-10 | RENAULT |
| PFR6G | SUBARU, VOLVO |

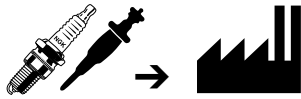

| | |
|------------------|--|
| PFR6G-11 | DODGE, HONDA, INFINITI, MITSUBISHI, NISSAN, OPEL, SUBARU |
| PFR6G-13E | JAGUAR |
| PFR6G-9 | OPEL, RENAULT, VAUXHALL |
| PFR6H-10 | SAAB |
| PFR6J | MITSUBISHI |
| PFR6J-11 | MITSUBISHI |
| PFR6N-11 | KIA, LAND ROVER, LOTUS, MG, MORGAN, ROVER |
| PFR6Q | AUDI, BENTLEY, SEAT, SKODA, VW |
| PFR6T-10G | OPEL, SAAB, VAUXHALL |
| PFR6T-G | OPEL, VAUXHALL |
| PFR6U-11G | AUDI |
| PFR6W-TG | AUDI, VW |
| PFR6X-11 | AUDI |
| PFR7B | ALFA ROMEO, ALPINA, AUDI, CHRYSLER, FORD, INFINITI, ISUZU, LANCIA, NISSAN, SUBARU, VOLVO |
| PFR7B-11 | FORD |
| PFR7B-9 | NISSAN |
| PFR7G | HONDA, MITSUBISHI, NISSAN, OPEL, RENAULT, SUBARU, VOLVO |
| PFR7G-11 | HONDA |
| PFR7G-11S | HONDA |
| PFR7H-10 | SAAB |
| PFR7Q | AUDI, PORSCHE |
| PFR7S8EG | AUDI, SEAT, SKODA, VW |
| PFR7W-T | AUDI |
| PFR7Z-TG | RENAULT |



| | |
|--------------------|--|
| PFR8B | ALPINA, AUDI, FORD, NISSAN |
| PFR8B-9 | PORSCHE |
| PGR5A-11 | HYUNDAI |
| PGR5C-11 | HYUNDAI, KIA |
| PGR6A | ALFA ROMEO, HYUNDAI |
| PGR6A-11 | MITSUBISHI |
| PGR7A | ALFA ROMEO, MITSUBISHI |
| PKR7A | BMW, WIESMANN |
| PLFR5A-11 | CITROËN, INFINITI, LANCIA, NISSAN, PEUGEOT, RENAULT |
| PLFR6A-11 | SUBARU, VOLVO |
| PLFR6A-9 | NISSAN |
| PLFR6C-10G | OPEL, SAAB, VAUXHALL |
| PLKR7A | MERCEDES-BENZ |
| PLTR6A-10G | FORD |
| PLZKAR6A-11 | NISSAN, RENAULT |
| PLZKBR7A-G | MINI, PEUGEOT |
| PMR7A | ALFA ROMEO |
| PMR8A | FERRARI, MASERATI |
| PMR8B | MASERATI |
| PMR9B | MASERATI |
| PTR4B-15 | BUICK |
| PTR5A-13 | CHEVROLET, FORD, HUMMER, MAZDA, MORGAN |
| PTR5D-10 | FORD, MAZDA |
| PTR6D-13 | ASTON MARTIN, JAGUAR |
| PTR6D-13G | FORD |
| PTR6F-13 | FORD |

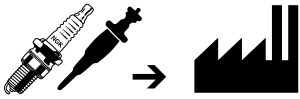

| | |
|-------------------|--|
| PZFR5D-11 | FORD, SEAT, SKODA, VW |
| PZFR5F | MAZDA |
| PZFR5J-11 | VW |
| PZFR5N-11T | AUDI, SEAT, SKODA, VW |
| PZFR6F | MAZDA |
| PZFR6F-11 | FORD USA, HONDA, JEEP |
| PZFR6J-11 | AUDI, SEAT, VW |
| PZFR6R | AUDI, SEAT, SKODA, VW |
| R7234-9 | FORD |
| RE8C-L | MAZDA |
| RE9B-T | MAZDA |
| SD11A | MAZDA |
| SILFR6A | SUBARU |
| SILFR6A11 | SUBARU |
| SILZKR7A-S | MERCEDES-BENZ |
| TR5 | DE LOREAN, FORD USA, HUMMER |
| TR55 | CADILLAC, CHEVROLET, FORD, FORD USA, PONTIAC |
| TR55IX | FORD |
| TR5A-10 | FORD |
| TR5B-13 | FORD, VOLVO |
| TR5IX | FORD, MAZDA |
| UR4 | BUICK |
| UR45 | JEEP |
| UR5 | BUICK |
| UR5IX | BUICK, JEEP |
| UR6IX | BUICK |



| | |
|-----------------|---|
| V-Line 1 | AUDI, FIAT, LANCIA, SEAT, SKODA, VW |
| V-Line 2 | ALFA ROMEO, AUSTIN, AUTOBIANCHI, BEDFORD, BMW, CHEVROLET, CHRYSLER, DAEWOO, DAIHATSU, FIAT, FORD, HONDA, INNOCENTI, ISUZU, KIA, LADA, LANCIA, LAND ROVER, LOTUS, MAZDA, MERCEDES-BENZ, MG, MITSUBISHI, MORGAN, NISSAN, OPEL, PANTHER, PININFARINA, PORSCHE, PROTON, RENAULT, ROVER, SEAT, SUBARU, SUZUKI, TALBOT, TVR, VAUXHALL, VOLVO, ZASTAVA |
| V-Line 3 | BEDFORD, FORD, OPEL |
| V-Line 4 | ALFA ROMEO, ASTON MARTIN, AUDI, AUSTIN, AUTOBIANCHI, BEDFORD, BMW, BOND, CITROËN, FIAT, FORD, FSO, GLAS, INNOCENTI, ISUZU, LADA, LANCIA, LAND ROVER, MASERATI, MERCEDES-BENZ, MG, MITSUBISHI, MORGAN, NISSAN, OPEL, PEUGEOT, RENAULT, ROVER, SAAB, SEAT, SUBARU, TALBOT, TRABANT, TRIUMPH, VAUXHALL, VOLVO, VW, WARTBURG, ZASTAVA, ZAZ |
| V-Line 5 | ALPINE, AUSTIN, CITROËN, LAND ROVER, MERCEDES-BENZ, PEUGEOT, PUCH, RENAULT, ROVER, TALBOT, TRIUMPH, VOLVO |
| V-Line 6 | ASIA MOTORS, BEDFORD, DAIHATSU, FIAT, HONDA, MARUTI, MAZDA, MITSUBISHI, NISSAN, OPEL, PROTON, RENAULT, SEAT, SUZUKI, TOYOTA, TRIUMPH, VAUXHALL, ZASTAVA |
| V-Line 7 | FORD, LANCIA, RENAULT, VOLVO |
| V-Line 8 | BMW, DAIMLER, HYUNDAI, ISUZU, JAGUAR, LAND ROVER, MG, MITSUBISHI, NISSAN, PEUGEOT, RENAULT, TRIUMPH, VW |
| V-Line 9 | DAIHATSU, HONDA, SUZUKI, TOYOTA, VW |
| V-Line10 | DAIHATSU, HONDA, TOYOTA |
| V-Line11 | ACURA, FORD, FORD USA, HONDA, LADA, MAZDA, MITSUBISHI, NISSAN, ROVER, SAAB, SUBARU |

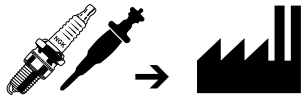

| | |
|-----------------|---|
| V-Line12 | ASTON MARTIN, AUTOBIANCHI, CHEVROLET, CHRYSLER, CITROËN, DAIMLER, FIAT, FORD, FSO, JAGUAR, LANCIA, MAZDA, MORGAN, NISSAN, PEUGEOT, PONTIAC, RENAULT, ROVER, SAAB, SKODA, TVR, VOLVO |
| V-Line13 | HYUNDAI, ISUZU, KIA, MAZDA, MITSUBISHI, NISSAN, OPEL, SUBARU |
| V-Line14 | CHEVROLET, DAEWOO, DAIHATSU, HONDA, ISUZU, KIA, MAZDA, MITSUBISHI, NISSAN, PEUGEOT, PROTON, ROVER, SUBARU, SUZUKI |
| V-Line15 | BERTONE, BMW |
| V-Line16 | CITROËN, DAEWOO, MERCEDES-BENZ, PEUGEOT, RENAULT, SAAB, SSANGYONG |
| V-Line17 | ALFA ROMEO, CITROËN, MERCEDES-BENZ, NISSAN, PEUGEOT, PUCH, RENAULT, ROVER |
| V-Line18 | CITROËN, DACIA, DAF, FORD, MERCEDES-BENZ, OPEL, PORSCHE, RENAULT, SEAT, SKODA, TALBOT, TRABANT, VOLVO, WARTBURG |
| V-Line19 | ALFA ROMEO, AUSTIN, AUTOBIANCHI, FIAT, FORD, LANCIA, LOTUS, MITSUBISHI, PININFARINA, PORSCHE, RENAULT, SUBARU, TALBOT, VOLVO |
| V-Line20 | ALPINA, BERTONE, BMW, CITROËN, DAEWOO, FIAT, LANCIA, MERCEDES-BENZ, OPEL, PEUGEOT, PORSCHE, SAAB, VAUXHALL, WIESMANN |
| V-Line21 | AUDI, SAAB, SEAT, VW |
| V-Line22 | AUDI, SEAT, VW |
| V-Line23 | CHEVROLET, CITROËN, DAEWOO, FIAT, LANCIA, NISSAN, OPEL, PEUGEOT, RENAULT, SAAB, VAUXHALL |
| V-Line24 | AUDI, MERCEDES-BENZ, SEAT, SKODA, VW |
| V-Line25 | CHEVROLET, FORD, HUMMER, MAZDA, MORGAN |



| | |
|-----------------|---|
| V-Line26 | DAIHATSU, FIAT, LANCIA, LOTUS |
| V-Line27 | FIAT, LANCIA, SEAT, VW |
| V-Line28 | AUDI, AUSTIN, CATERHAM, CHRYSLER, CITROËN, DACIA, FIAT, HYUNDAI, KIA, LADA, LAND ROVER, MAZDA, MERCEDES-BENZ, NISSAN, OPEL, PANTHER, PEUGEOT, PORSCHE, RENAULT, ROVER, SKODA, SUZUKI, VOLVO, VW |
| V-Line29 | MERCEDES-BENZ, VW |
| V-Line30 | ALPINA, AUDI, BENTLEY, BMW, LAND ROVER, MINI, MORGAN, PORSCHE, ROLLS-ROYCE, VOLVO |
| V-Line31 | FORD, MAZDA |
| V-Line32 | CITROËN, PEUGEOT, RENAULT, SKODA |
| V-Line33 | CHEVROLET, DAEWOO, DAIHATSU, HYUNDAI, INFINITI, KIA, MAZDA, MITSUBISHI, NISSAN, SUBARU |
| V-Line34 | FORD, SEAT, SKODA, VW |
| V-Line35 | KIA, MAZDA, NISSAN, VW |
| V-Line36 | CITROËN, FIAT, LANCIA, PEUGEOT, RENAULT |
| V-Line37 | AUDI, BENTLEY, SEAT, SKODA, VW |
| V-Line38 | CITROËN, DACIA, FIAT, LANCIA, NISSAN, PEUGEOT, RENAULT |
| V-Line39 | TOYOTA |
| Y-1002AS | AUDI, SKODA, VW |
| Y-1005J | CITROËN, FIAT, FORD, LANCIA, PEUGEOT |
| Y-1006J | MAZDA |
| Y-1007J | MITSUBISHI |
| Y-107 T | KIA |
| Y-107R | ASIA MOTORS, FORD, MAZDA |



| | |
|----------------|---|
| Y-112M1 | NISSAN |
| Y-112R1 | NISSAN |
| Y-115R1 | MAZDA |
| Y-115T1 | HYUNDAI, MAZDA |
| Y-117RS | NISSAN |
| Y-117SS | NISSAN |
| Y-118R | TOYOTA, VW |
| Y-128T | DAIHATSU |
| Y-146R | DAIHATSU, TOYOTA |
| Y-147T | TOYOTA |
| Y-162R1 | NISSAN |
| Y-168R | TOYOTA |
| Y-197R | TOYOTA |
| Y-204RS | NISSAN |
| Y-204SS | NISSAN |
| Y-208T | CITROËN, FIAT, FORD, LAND ROVER, MAHINDRA, OPEL, PEUGEOT, RENAULT, SEAT |
| Y-306R | OPEL |
| Y-307R | VAUXHALL |
| Y-403T | OPEL |
| Y-404 | PEUGEOT |
| Y-405 | CITROËN |
| Y-501U | AUDI, SKODA, VW |
| Y-502R | CITROËN, FIAT, RENAULT |
| Y-503J | CITROËN, FIAT, NISSAN, PEUGEOT, RENAULT, ROVER |
| Y-503R | CITROËN, FIAT, PEUGEOT, RENAULT |



| | |
|----------------|---|
| Y-504J | CITROËN, FIAT, LANCIA, PEUGEOT, SUZUKI |
| Y-504R | CITROËN, FIAT, LANCIA, PEUGEOT, SUZUKI |
| Y-506J | OPEL, RENAULT, VAUXHALL |
| Y-507J | BMW, LAND ROVER, MG, ROVER |
| Y-507R | BMW, LAND ROVER, ROVER |
| Y-508J | KIA |
| Y-515J | DACIA, MAZDA, NISSAN, OPEL, RENAULT, SUZUKI, VOLVO |
| Y-516J | RENAULT |
| Y-517J | NISSAN, OPEL, RENAULT, VAUXHALL |
| Y-519J | NISSAN |
| Y-522J | NISSAN |
| Y-523J | OPEL, VAUXHALL |
| Y-524J | FORD |
| Y-525J | FORD, JAGUAR |
| Y-529J | MAZDA |
| Y-530J | NISSAN |
| Y-531J | TOYOTA |
| Y-532J | TOYOTA |
| Y-534J | ALFA ROMEO, FIAT, LANCIA, OPEL, SUZUKI, VAUXHALL |
| Y-541J | HONDA, OPEL, VAUXHALL |
| Y-542J | TOYOTA |
| Y-543J | FIAT, SMART |
| Y-547AS | BMW |
| Y-603J | OPEL, VAUXHALL |
| Y-604J | VAUXHALL |

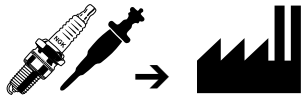

| | |
|-----------------|--|
| Y-607AS | AUDI, SEAT, SKODA, VW |
| Y-609AS | AUDI, VW |
| Y-701J | FORD, KIA, MAZDA, SUZUKI |
| Y-701R | KIA, MAZDA, SUZUKI |
| Y-703R | DAIHATSU, TOYOTA |
| Y-705RS | NISSAN |
| Y-707RS | CARBODIES, LTI, NISSAN |
| Y-710J | SSANGYONG, VAUXHALL |
| Y-711J | ISUZU, OPEL, VAUXHALL |
| Y-712RS | FORD, NISSAN |
| Y-715R | TOYOTA, VW |
| Y-719RS1 | OPEL, VAUXHALL |
| Y-721J | KIA |
| Y-722J | HYUNDAI |
| Y-722JS | HYUNDAI |
| Y-729U | LAND ROVER |
| Y-730U | HONDA, LAND ROVER, RENAULT, ROVER |
| Y-731U | CITROËN, PEUGEOT, ROVER |
| Y-732J | AUDI, DACIA, FORD, MITSUBISHI, NISSAN, OPEL, RENAULT, SEAT, SKODA, SUZUKI, VAUXHALL, VOLVO, VW |
| Y-733J | MITSUBISHI |
| Y-738U | CITROËN, PEUGEOT |
| Y-740U | HONDA, RENAULT, VOLVO |
| Y-741U | AUDI, CHRYSLER, FORD, JEEP, OPEL, SEAT, SKODA, VAUXHALL, VW |
| Y-745U | CHRYSLER, JEEP, MERCEDES-BENZ, SSANGYONG |
| Y-746J | MERCEDES-BENZ |



| | |
|-----------------|---|
| Y-746R | MERCEDES-BENZ |
| Y-747U | ALFA ROMEO, FIAT, LANCIA |
| Y-748U | KIA, OPEL, SAAB, VAUXHALL |
| Y-749J | HYUNDAI, KIA |
| Y-8001AS | CITROËN, PEUGEOT |
| Y8002AS | CHRYSLER, MERCEDES-BENZ |
| Y-810 | PEUGEOT |
| Y-902R | ALFA ROMEO, BMW, CITROËN, FIAT, FORD, FSO, INNOCENTI, LADA, LANCIA, MERCEDES-BENZ, PEUGEOT, RENAULT, ROVER, SEAT, TALBOT, VAUXHALL |
| Y-904M1 | ISUZU, OPEL, VAUXHALL |
| Y-907R | FORD |
| Y-908R | ARO, FIAT, JEEP, LANCIA, OPEL, RENAULT |
| Y-909R | ALFA ROMEO, FIAT, LAND ROVER |
| Y-910J | CITROËN, FIAT, FORD, MAZDA, OPEL, PEUGEOT, RENAULT, ROVER, VAUXHALL |
| Y-910R | FORD, MAZDA |
| Y-911J | CITROËN, PEUGEOT, ROVER |
| Y-913J | RENAULT, VOLVO |
| Y-913M | RENAULT, VOLVO |
| Y-914U | FIAT, LANCIA, RENAULT |
| Y-916J | DAEWOO, MERCEDES-BENZ, SSANGYONG |
| Y-916R | DAEWOO, MERCEDES-BENZ, SSANGYONG |
| Y-917U | BMW, OPEL |
| Y-918J | AUDI, FSO, SEAT, SKODA, VOLVO, VW |
| Y-918R | AUDI, FSO, SEAT, SKODA, VOLVO, VW |

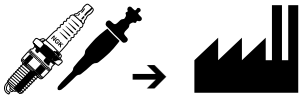

| | |
|---------------|--|
| Y-920R | FIAT |
| Y-922R | ALFA ROMEO, FIAT, LANCIA |
| Y-923U | ALFA ROMEO, CHRYSLER, CITROËN, FIAT, FORD, JEEP, LANCIA, MERCEDES-BENZ, PEUGEOT, ROVER, SUZUKI |
| Y-924J | ALFA ROMEO, ARO, BMW, CHRYSLER, CITROËN, FIAT, FORD, FSO, HYUNDAI, INNOCENTI, JEEP, LADA, LANCIA, LAND ROVER, MERCEDES-BENZ, OPEL, PEUGEOT, RENAULT, ROVER, SEAT, SUZUKI, TALBOT, VAUXHALL |
| Y-924U | FIAT, OPEL, PEUGEOT, VAUXHALL |
| Y-925J | MERCEDES-BENZ |
| Y-925R | MERCEDES-BENZ |
| Y-927J | RENAULT |
| Y-927R | RENAULT |
| Y-928U | FIAT, LANCIA |
| Y-929U | DAEWOO, MERCEDES-BENZ |
| Y-930U | MERCEDES-BENZ |
| Y-932R | ARO, MITSUBISHI, RENAULT, VOLVO |
| Y-933J | ARO, MITSUBISHI, RENAULT, VOLVO |
| Y-933R | RENAULT, VOLVO |
| Y-935U | FIAT, OPEL |
| Y-937J | FORD |
| Y-937R | FORD |
| Y-938R | CITROËN, FIAT, HYUNDAI, PEUGEOT, SUZUKI |
| Y-939J | FIAT |
| YE04 | CITROËN, FORD, MAZDA, PEUGEOT, SUZUKI, VOLVO |
| YE05 | CITROËN, PEUGEOT |



| | |
|-------------------|--|
| YE06 | FIAT, OPEL, SUZUKI, VAUXHALL |
| YE07 | ALFA ROMEO, OPEL, SAAB, VAUXHALL |
| YE08 | CITROËN, PEUGEOT |
| YE12 | CITROËN, JAGUAR, PEUGEOT, VOLVO |
| YE13 | MITSUBISHI, SMART |
| YE14 | AUDI, MITSUBISHI, SEAT, SKODA, VW |
| ZFR5A-11 | CHRYSLER, JEEP |
| ZFR5E-11 | FORD, NISSAN |
| ZFR5F | BMW, CHRYSLER, KIA, OPEL, VAUXHALL |
| ZFR5F-11 | DODGE, HONDA, HYUNDAI, JEEP, MAZDA, OPEL, VAUXHALL |
| ZFR5J-11 | HONDA |
| ZFR5LP-13G | CHRYSLER |
| ZFR5P-G | SEAT, SKODA, VW |
| ZFR6A-11 | MAZDA |
| ZFR6BP-G | VAUXHALL |
| ZFR6F-11 | FORD USA, HONDA, MAZDA, OPEL, ROVER |
| ZFR6J-11 | HONDA |
| ZFR6K-11 | HONDA |
| ZFR6S-Q | AUDI, SKODA, VW |
| ZFR6T-11G | SEAT, SKODA, VW |
| ZGR5A | BERTONE, BMW |
| ZGR5B | VOLVO |
| ZKR7A-10 | FIAT, FORD, LANCIA, |



| | |
|---------------------|---|
| AC | BPR5FS-11 |
| ACURA | BCPR6E-11, LPG 3, V-Line11 |
| ALFA ROMEO | B7ES, B8ES, BCP6E, BCP6ES, BCP7ES, BKR6EKPA, BKUR6ETB, BP6E, BP6ES, BP6ET, BP7ES, BP8ES, BPR6E, BPR6ES, BPR7E, BPR7ES, BPR8EIX, BPR9EIX, BR8EIX, BR9EIX, CR7EKC, D-Power 1, D-Power 26, D-Power 36, FR5CP, IKR9F8, LPG 1, LPG 2, LPG 3, PFR6B, PFR7B, PGR6A, PGR7A, PMR7A, V-Line 2, V-Line 4, V-Line17, V-Line19, Y-534J, Y-747U, Y-902R, Y-909R, Y-922R, Y-923U, Y-924J, YE07 |
| ALPINA | BKR6EK, BKR6EQUP, LPG 1, PFR7B, PFR8B, V-Line20, V-Line30 |
| ALPINE | B7HVX, B8EVX, B9EGP, BKUR7ET, BP6EF, BP6EFS, BP7EFVX, BR8HIX, BR9EIX, BU6EFSZ, LPG 5, V-Line 5 |
| ARO | BP5ESZ, D-Power 1, D-Power 25, LPG 2, Y-908R, Y-924J, Y-932R, Y-933J |
| ASIA MOTORS | BPR5E, BPR5ES, LPG 2, V-Line 6, Y-107R |
| ASTON MARTIN | BCPR6E, BCPR6ES, BCPR7ES, BP6E, BP6ES, BPR6EY, BPR7EY, LPG 2, LPG 3, LPG 5, PTR6D-13, V-Line 4, V-Line12 |
| AUDI | B7ES, BCP7ET, BKR6E, BKR6EKUB, BKR6EQUA, BKR6EQUP, BKUR5ET-10, BKUR6ET-10, BKUR7ET, BP6E, BP6ES, BP6ESZ, BP7ES, BP7EVX, BPR5EQU, BPR8EIX, BR8EIX, BUR5ET, BUR5ET-10, BUR6EFSZ, BUR6ET, CZ104, CZ304, D-Power 2, D-Power 20, D-Power 31, D-Power 4, D-Power 48, D-Power 49, D-Power 50, D-Power 52, D-Power 55, D-Power 57, ILZKR7A, IZKR7B, LPG 1, LPG 2, LPG 6, PFR5B, PFR6B, PFR6Q, PFR6U-11G, PFR6W-TG, PFR6X-11, PFR7B, PFR7Q, PFR7S8EG, PFR7W-T, PFR8B, PZFR5N-11T, PZFR6J-11, PZFR6R, V-Line 1, V-Line 4, V-Line21, V-Line22, V-Line24, V-Line28, V-Line30, V-Line37, Y-1002AS, Y-501U, Y-607AS, Y-609AS, Y-732J, Y-741U, Y-918J, Y-918R, YE14, ZFR6S-Q |

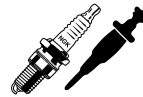

| | |
|--------------------|--|
| AUSTIN | BKR6E, BKR6ES, BP6E, BP6EF, BP6EFS, BP6ES, BPR6E, BPR6ES, BPR7E, BPR7ES, BPR8EIX, LPG 1, LPG 2, LPG 5, V-Line 2, V-Line 4, V-Line 5, V-Line19, V-Line28 |
| AUTO UNION | A6, A7, AB6, AB7, B6HS, BR7HIX |
| AUTOBIANCHI | BCPR6E, BCPR6ES, BP6E, BP6ES, BPR6E, BPR6ES, BPR7E, BPR7ES, BPR8EIX, BR8EIX, BR8ES, LPG 2, LPG 3, V-Line 2, V-Line 4, V-Line12, V-Line19 |
| BARKAS | B6HS, BR7HIX |
| BEDFORD | BP6E, BP6ES, BPR5E, BPR5ES, BPR6E, BPR6ES, BPR6FS, BPR6H, BPR6HS, BPR7HIX, LPG 2, V-Line 2, V-Line 3, V-Line 4, V-Line 6 |
| BENTLEY | BKR5EVX, BKR6EQUP, LPG 1, PFR6Q, V-Line30, V-Line37 |
| BERTONE | BKR6EK, LPG 1, V-Line15, V-Line20, ZGR5A |
| BMW | B7ES, B7HS, B8ES, B8HS, B9HVX, BKR6EK, BKR6EQU, BKR6EQUP, BP5E, BP5ES, BP6E, BP6ES, BP7ES, BPR6E, BPR6ES, BPR8EIX, BR8EIX, BR8HIX, BR9EIX, D7EA, D8EVX, DCPR8EKP, D-Power 1, D-Power 32, D-Power 47, ILZFR6D11, IZFR6H-11, LKR8AP, LPG 1, LPG 2, LPG 6, PKR7A, V-Line 2, V-Line 4, V-Line 8, V-Line15, V-Line20, V-Line30, Y-507J, Y-507R, Y-547AS, Y-902R, Y-917U, Y-924J, ZFR5F, ZGR5A |
| BOND | BP6E, BP6ES, LPG 2, V-Line 4 |
| BORGWARD | B6HS, B7HS, BR7HIX, BR8HIX |
| BUICK | LPG 5, PTR4B-15, UR4, UR5, UR5IX, UR6IX |
| CADILLAC | LPG 5, TR55 |
| CARBODIES | Y-707RS |
| CATERHAM | B8ECS, BCPR7ES, BKR6E, BKR6ES, LPG 1, V-Line28 |

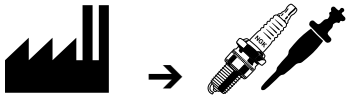

| | |
|------------------|--|
| CHEVROLET | BCPR6E, BCPR6ES, BKR5E-11, BKR5EK, BKR6E-11, BKUR6ETB, BPR5EY-11, BPR6E, BPR6ES, DCPR8E, IFR6E11, LPG 1, LPG 2, LPG 3, LPG 4, LPG 5, LPG 8, PTR5A-13, TR55, V-Line 2, V-Line12, V-Line14, V-Line23, V-Line25, V-Line33 |
| CHRYSLER | BCPR6E, BCPR6ES, BKR6E, BPR5ES-11, BPR6E, BPR6ES, D-Power 1, D-Power 11, D-Power 20, D-Power 51, FR5-1, GR4, GR4IX, GR5IX, IFR6D10, LPG 1, LPG 2, LPG 3, LPG 6, LZTR4A-11, LZTR5A-13, PFR6B-11, PFR7B, V-Line 2, V-Line12, V-Line28, Y-741U, Y-745U, Y8002AS, Y-923U, Y-924J, ZFR5A-11, ZFR5F, ZFR5LP-13G |
| CITROËN | B6HS, BCP5E, BCP5ES, BCP6E, BCP6ES, BCP6ET, BCPR5E, BCPR5ES, BCPR6E, BCPR6ES, BCPR6ET, BCPR7EIX, BCPR7ES, BKR5EK, BKR5EZ, BKR6E, BKR6EK, BKR6ES, BKR6EZ, BKUR7ET, BP6E, BP6EF, BP6EFS, BP6ES, BP6H, BP6HS, BP7EFS, BPR7HIX, BR7HIX, D-Power 1, D-Power 10, D-Power 24, D-Power 3, D-Power 33, D-Power 40, D-Power 56, D-Power 58, D-Power 9, LFR5B, LFR6B, LFR6C-11, LPG 1, LPG 2, LPG 3, LPG 5, LPG 7, LZKAR7A, PLFR5A-11, V-Line 4, V-Line 5, V-Line12, V-Line16, V-Line17, V-Line18, V-Line20, V-Line23, V-Line28, V-Line32, V-Line36, V-Line38, Y-1005J, Y-208T, Y-405, Y-502R, Y-503J, Y-503R, Y-504J, Y-504R, Y-731U, Y-738U, Y-8001AS, Y-902R, Y-910J, Y-911J, Y-923U, Y-924J, Y-938R, YE04, YE05, YE08, YE12 |
| DACIA | BKR6E, BKR6EZ, BP6H, BP6HS, BPR7HIX, D-Power 18, D-Power 4, LPG 1, V-Line18, V-Line28, V-Line38, Y-515J, Y-732J |
| DAEWOO | BCP5E, BCP5ES, BKR5E-11, BKR5EK, BKR6E-11, BKR6EK, BPR5EY-11, BPR6E, BPR6ES, D-Power 41, D-Power 6, LPG 1, LPG 2, LPG 3, V-Line 2, V-Line14, V-Line16, V-Line20, V-Line23, V-Line33, Y-916J, Y-916R, Y-929U |

| | |
|------------------|---|
| DAF | BP6H, BP6HS, BPR7HIX, V-Line18 |
| DAIHATSU | BKR5E-11, BKR5EK, BKR6E-11, BKR6EK, BKR6EP-8, BKR6EY-11, BKUR6EK, BKUR6ETB-10, BPR4EY, BPR5E, BPR5EA-L, BPR5ES, BPR5EY, BPR5EY-11, BPR6E, BPR6EKN, BPR6ES, BPR6EY, BPR6EY-11, IFR6J-11, IKR7D, LFR6C-11, LPG 1, LPG 2, V-Line 2, V-Line 6, V-Line 9, V-Line10, V-Line14, V-Line26, V-Line33, Y-128T, Y-146R, Y-703R |
| DAIMLER | BCPR6E, BCPR6ES, BP5E, BP5ES, BP7ES, BPR8EIX, BR6EF, BR7EF, BR7EFS, LPG 2, LPG 3, V-Line 8, V-Line12 |
| DE LOREAN | LPG 5, TR5 |
| DODGE | FR45, FR5, LPG 6, PFR5G-11, PFR6G-11, ZFR5F-11 |
| FERRARI | BP7ES, BP8EVX, BPR8EIX, BPR9EIX, C8E, CR8EVX, D8EVX, DCPR9EVX, PMR8A |
| FIAT | B7ES, B7HS, B9ES, BCPR6E, BCPR6ES, BCPR6ET, BCPR7E, BCPR7EIX, BCPR7ES, BCPR7ET, BKR5EK, BKR5EZ, BKR6E, BKR6EK, BKR6EK, BKR6ES, BKR6EZ, BKR7E, BKR8EIX, BKUR6ET, BP6E, BP6ES, BP6ET, BP7ES, BP8ES, BPR5E, BPR5ES, BPR6E, BPR6ES, BPR7E, BPR7ES, BPR7HS, BPR8EIX, BPR8HIX, BPR9EIX, BR10EIX, BR8EIX, BR8ES, BR8HIX, BUR6ET, DCPR7E-N, DCPR7E-N-10, DCPR8E, DCPR8EK, DCPR8E-N, D-Power 1, D-Power 10, D-Power 23, D-Power 24, D-Power 26, D-Power 29, D-Power 3, D-Power 36, D-Power 43, D-Power 46, D-Power 56, IFR6J-11, IKR9F8, LFR5B, LPG 1, LPG 2, LPG 3, LPG 7, LPG 8, LTR6B-10T, V-Line 1, V-Line 2, V-Line 4, V-Line 6, V-Line12, V-Line19, V-Line20, V-Line23, V-Line26, V-Line27, V-Line28, V-Line36, V-Line38, Y-1005J, Y-208T, Y-502R, Y-503J, Y-503R, Y-504J, Y-504R, Y-534J, Y-543J, Y-747U, Y-902R, Y-908R, Y-909R, Y-910J, Y-914U, Y-920R, Y-922R, Y-923U, |



| | |
|-----------------|---|
| | Y-924J, Y-924U, Y-928U, Y-935U, Y-938R, Y-939J, YE06, ZKR7A-10 |
| FORD | AP6FS, APR5FS, APR6FS, B6HS, B7HS, BCPR6E, BCPR6E-11, BCPR6ES, BCPR6ES-11, BCPR7EIX, BCPR7ES, BCPR7ES-11, BCPR9ES-11, BCR8ES, BKR5EKUP, BKR6EVX-11, BKR7EVX-11, BKR8EIX, BP6E, BP6ES, BP6H, BP6HS, BP7ES, BP7HS, BPM7F, BPR6E, BPR6EF, BPR6EFS, BPR6ES, BPR6H, BPR6HS, BPR7E, BPR7ES, BPR7HIX, BPR7HS, BPR8EIX, BPR8HIX, BR7HIX, BR8HIX, CY58, D-Power 1, D-Power 20, D-Power 27, D-Power 3, D-Power 35, D-Power 39, D-Power 4, D-Power 40, D-Power 5, D-Power 56, ILTR5A-13G, ILTR6A-13G, ITR6F-13, LPG 1, LPG 2, LPG 3, LPG 4, LPG 5, LPG 6, LPG 8, PFR6B-11, PFR7B, PFR7B-11, PFR8B, PLTR6A-10G, PTR5A-13, PTR5D-10, PTR6D-13G, PTR6F-13, PZFR5D-11, R7234-9, TR55, TR55IX, TR5A-10, TR5B-13, TR5IX, V-Line 2, V-Line 3, V-Line 4, V-Line 7, V-Line11, V-Line12, V-Line18, V-Line19, V-Line25, V-Line31, V-Line34, Y-1005J, Y-107R, Y-208T, Y-524J, Y-525J, Y-701J, Y-712RS, Y-732J, Y-741U, Y-902R, Y-907R, Y-910J, Y-910R, Y-923U, Y- 924J, Y-937J, Y-937R, YE04, ZFR5E-11, ZKR7A-10 |
| FORD USA | BCPR6E-11, BCPR6ES-11, LPG 3, LPG 5, LPG 6, PZFR6F-11, TR5, TR55, V- Line11, ZFR6F-11 |
| FSO | BCPR6E, BCPR6ES, BP6E, BP6ES, BP7HS, D-Power 1, D-Power 2, LPG 2, LPG 3, V-Line 4, V-Line12, Y-902R, Y-918J, Y-918R, Y-924J |
| GLAS | A7, AB7, B6ES, BP6E, BP6ES, LPG 2, V-Line 4 |
| HONDA | BCPR6E-11, BCPR6EY-11, BCPR6EY-N-11, BKR6E-11, BKR6E-N-11, BKR7E-N-11, BPR5E, BPR5ES, BPR5EY, BPR5EY-11, BPR6E, BPR6ES, BPR6EY, BPR6EY-11, BR6ES, BR7EIX, D-Power 17, D-Power 22, D-Power 42, IFR5G-11K, IFR7G-11KS, ILFR6J-11K, ILZKR7B-11GS, |

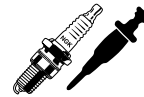

| | |
|------------------|---|
| | IZFR6K-11, IZFR6K-11S, LPG 1, LPG 2, LPG 3, LPG 6, PFR5G-11, PFR6G-11, PFR7G, PFR7G-11, PFR7G-11S, PZFR6F-11, V-Line 2, V-Line 6, V-Line 9, V-Line10, V-Line11, V-Line14, Y-541J, Y-730U, Y-740U, ZFR5F-11, ZFR5J-11, ZFR6F-11, ZFR6J-11, ZFR6K-11 |
| HUMMER | LPG 4, LPG 5, PTR5A-13, TR5, V-Line25 |
| HYUNDAI | BKR5E-11, BKR5ES-11, BKR6E, BKR6ES, BP5E, BP5ES, BP6ES-11, BP6EY-11, BPR5ES-11, BPR6ES-11, BUR6EA-11, CY57, D-Power 1, D-Power 21, ILFR5B-11, LPG 1, LPG 2, LPG 6, PFR5B-11, PFR5J-11, PFR5N-11, PFR6B, PGR5A-11, PGR5C-11, PGR6A, V-Line 8, V-Line13, V-Line28, V-Line33, Y-115T1, Y-722J, Y-722JS, Y-749J, Y-924J, Y-938R, ZFR5F-11 |
| INFINITI | BKR5E-11, BKR5ES-11, LPG 1, LPG 7, PFR5B-11, PFR5G-11, PFR6B, PFR6B-11, PFR6G-11, PFR7B, PLFR5A-11, V-Line33 |
| INNOCENTI | BP6E, BP6ES, BPR6E, BPR6ES, D- Power 1, LPG 2, V-Line 2, V-Line 4, Y-902R, Y-924J |
| ISUZU | BKR6E-11, BP5E, BP5ES, BP6E, BP6ES, BPR6E, BPR6ES, BPR6ES-11, D-Power 28, LPG 1, LPG 2, PFR6B-11, PFR7B, V-Line 2, V-Line 4, V-Line 8, V-Line13, V-Line14, Y-711J, Y-904M1 |
| JAGUAR | B6EFS, B8ES, BCPR6E, BCPR6ES, BKR5EVXA-13, BKR6EVXA-11, BKR6EVXA-13, BKR7E, BKR8EIX, BP5E, BP5ES, BP7ES, BPR8EIX, BR7EF, BR7EFS, BR9EIX, D-Power 35, IFR5N10, LPG 1, LPG 2, LPG 3, LPG 5, PFR5G-11E, PFR5G-13E, PFR6G-13E, PTR6D-13, V-Line 8, V-Line12, Y-525J, YE12 |
| JEEP | D-Power 1, D-Power 11, D-Power 20, FR4, FR5-1, GR4, GR5IX, LPG 6, LZTR4A-11, PZFR6F-11, UR45, UR5IX, Y-741U, Y-745U, Y-908R, Y-923U, Y-924J, ZFR5A-11, ZFR5F-11 |

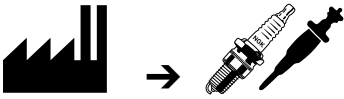

| | |
|-------------------|---|
| KIA | BK6E, BK6E-11, BKR5E, BKR5E-11, BKR5ES, BKR5ES-11, BKR6E, BKR6E-11, BKR6ES, BKR6ES-11, BPR5ES-11, BPR5EY-11, BPR6E, BPR6ES, BPR6ES-11, D-Power 14, D-Power 39, ILFR5B-11, LPG 1, LPG 2, LPG 6, PFR5N-11, PFR6N-11, PGR5C-11, V-Line 2, V-Line13, V-Line14, V-Line28, V-Line33, V-Line35, Y-107 T, Y-508J, Y-701J, Y-701R, Y-721J, Y-748U, Y-749J, ZFR5F |
| LADA | BCPR6E-11, BCPR6ES-11, BKR6E, BP6E, BP6ES, BPR6E, BPR6ES, D-Power 1, LPG 1, LPG 2, LPG 3, V-Line 2, V-Line 4, V-Line11, V-Line28, Y-902R, Y-924J |
| LANCIA | BCPR6E, BCPR6ES, BCPR6ET, BCPR7ES, BKR5EK, BKR5EZ, BKR6EK, BKR6EKC, BKR6EZ, BKUR6ET, BKUR6ETB, BP6E, BP6ES, BP6ET, BPR6E, BPR6EF, BPR6EFS, BPR6ES, BPR7E, BPR7ES, BPR8EIX, BR8EIX, BR8ES, BUR6ET, D8EA, DCPR7E-N, DCPR8E, DCPR9E, D-Power 1, D-Power 24, D-Power 26, D-Power 29, D-Power 36, D-Power 56, IKR9F8, LPG 1, LPG 2, LPG 3, LPG 5, LPG 7, LPG 8, PFR6B, PFR7B, PLFR5A-11, V-Line 1, V-Line 2, V-Line 4, V-Line 7, V-Line12, V-Line19, V-Line20, V-Line23, V-Line26, V-Line27, V-Line36, V-Line38, Y-1005J, Y-504J, Y-504R, Y-534J, Y-747U, Y-902R, Y-908R, Y-914U, Y-922R, Y-923U, Y-924J, Y-928U, ZKR7A-10 |
| LAND ROVER | BKR6E, BKR6EQUP, BP5E, BP5ES, BP5HS, BP6E, BP6EF, BP6EFS, BP6ES, BPR6E, BPR6ES, D-Power 1, D-Power 17, D-Power 32, D-Power 34, IFR5N10, LPG 1, LPG 2, LPG 5, PFR6N-11, V-Line 2, V-Line 4, V-Line 5, V-Line 8, V-Line28, V-Line30, Y-208T, Y-507J, Y-507R, Y-729U, Y-730U, Y-909R, Y-924J |
| LEXUS | BKR5EP-11, BKR6EKP-11, BKR6EP-11, BKR6EP-8, IFR6T-11, LPG 1 |

| | |
|----------------------|--|
| LOTUS | BKR6EKC, BKR7E, BKR8EIX, BPR6E, BPR6EKN, BPR6ES, BPR7E, BPR7ES, BPR8EIX, LPG 1, LPG 2, PFR6N-11, V-Line 2, V-Line19, V-Line26 |
| LTI | Y-707RS |
| MAHINDRA | Y-208T |
| MARUTI | BPR5E, BPR5ES, LPG 2, V-Line 6 |
| MASERATI | BP6E, BP6ES, BP8ES, BPR9EIX, DCPR9E, LPG 2, PMR8A, PMR8B, PMR9B, V-Line 4 |
| MAYBACH | IFR6Q-G |
| MAZDA | BCPR6E, BCPR6E-11, BCPR6ES, BKR5E, BKR5E-11, BKR6E, BKR6E-11, BKR6EVX-11, BPR5E, BPR5ES, BPR5ES-11, BPR6E, BPR6ES, BPR6ES-11, BR10ET, BR8ET, BR9EIX, BUR9EQ, BUR9EQP, D-Power 3, D-Power 39, D-Power 40, IFR5E-11, IFR5E13, IFR6E11, ILTR5A-13G, ILTR6A-13G, ITR5F-13, ITR6F-13, LPG 1, LPG 2, LPG 3, LPG 4, LPG 5, LPG 6, PTR5A-13, PTR5D-10, PZFR5F, PZFR6F, RE8C-L, RE9B-T, SD11A, TR5IX, V-Line 2, V-Line 6, V-Line11, V-Line12, V-Line13, V-Line14, V-Line25, V-Line28, V-Line31, V-Line33, V-Line35, Y-1006J, Y-107R, Y-529J, Y-701J, Y-701R, Y-910J, Y-910R, YE04, ZFR5F-11, ZFR6A-11, ZFR6F-11 |
| MERCEDES-BENZ | B5HS, BCP5E, BCP5ES, BCP6E, BCP6ES, BKR5EKU, BKR5EKUP, BKR6E, BKR6EK, BKR6ES, BKR6EZB, BKUR5ET, BKUR5ET-10, BKUR6ET-10, BP5EFS, BP6E, BP6EF, BP6EFS, BP6ES, BP6H, BP6HS, BP7EFVX, BP7ES, BP8EVX, BPR6E, BPR6ES, BPR7HIX, BPR8EIX, BPR9EIX, CZ106, CZ303, D-Power 1, D-Power 11, D-Power 16, D-Power 30, D-Power 38, D-Power 41, D-Power 51, D-Power 53, D-Power 54, D-Power 6, IFR6D10, IFR6Q-G, ILFR6A, LPG 1, LPG 2, LPG 3, LPG 5, PFR5R-11, PLKR7A, SILZKR7A-S, V-Line 2, V-Line 4, V-Line 5, V-Line16, V-Line17, V-Line18, V-Line20, V-Line24, V-Line28, V-Line29, Y-745U, Y-746J, |



| | |
|-------------------|--|
| | Y-746R, Y8002AS, Y-902R, Y-916J, Y-916R, Y-923U, Y-924J, Y-925J, Y-925R, Y-929U, Y-930U |
| MG | BP5E, BP5ES, BP5HS, BP6E, BP6ES, BPR6E, BPR6ES, D-Power 32, LPG 2, PFR6N-11, V-Line 2, V-Line 4, V-Line 8, Y-507J |
| MINI | BKR6EQUP, ILZKBR7A-8G, LPG 1, PLZKBR7A-G, V-Line30 |
| MITSUBISHI | BCPR6E-11, BCPR6ES-11, BK6E, BK6E-11, BKR5E-11, BKR6E-11, BP5E, BP5ES, BP6E, BP6ES, BPR5E, BPR5ES, BPR5ES-11, BPR6E, BPR6ES, BPR6ES-11, BPR7E, BPR7ES, BPR7ES-11, BPR8EIX, BR7ES, BR8EIX, BUR6EA-11, BUR7EA-11, CY55, CY57, DILFR5A11, DILKR8B6, D-Power 13, D-Power 18, D-Power 21, D-Power 25, D-Power 4, D-Power 48, D-Power 59, FR6EI, HB6BIX-11P, IGR6A-11, IGR7A-G, ILFR7H, ILZFR6C-11K, ILZFR6C-K, IZFR5B, IZFR6B, LFR6C-11, LPG 1, LPG 2, LPG 3, LZFR6AI, PFR5J-11, PFR6G-11, PFR6J, PFR6J-11, PFR7G, PGR6A-11, PGR7A, V-Line 2, V-Line 4, V-Line 6, V-Line 8, V-Line11, V-Line13, V-Line14, V-Line19, V-Line33, Y-1007J, Y-115R1, Y-115T1, Y-515J, Y-732J, Y-733J, Y-932R, Y-933J, YE13, YE14 |
| MORGAN | BCPR6E, BCPR6ES, BKR6EQUP, BP6E, BP6ES, BPR6E, BPR6ES, LPG 1, LPG 2, LPG 3, LPG 4, PFR6N-11, PTR5A-13, V-Line 2, V-Line 4, V-Line12, V-Line25, V-Line30 |
| MOSKVICH | BP7ES, BP8EVX, BPR8EIX, BPR9EIX |
| NISSAN | BCP5ES-11, BCP6E, BCP6ES, BCP6ES-11, BCPR5ES-11, BCPR6E, BCPR6E-11, BCPR6ES, BCPR6ES-11, BKR5E, BKR5E-11, BKR5EK, BKR5EY, BKR5EY-11, BKR6E, BKR6E-11, BKR6ES-11, BKR6EY, BKR6EZ, BP5E, BP5ES, BP6E, BP6ES, BPR5E, BPR5E-11, BPR5ES, BPR5ES-11, BPR6E, BPR6ES, BPR6ES-11, BR6ES-11, BR7EIX, CX51, CY51, CY52, CY58, CZ51, CZ71, D-Power 10, |



| | |
|----------------|--|
| | D-Power 18, D-Power 4, LFR5A-11, LFR5AIX-11, LFR5AP-11, LPG 1, LPG 2, LPG 3, LPG 7, LZKAR7A, PFR6A-11, PFR6B-11, PFR6B-9, PFR6G-11, PFR7B, PFR7B-9, PFR7G, PFR8B, PLFR5A-11, PLFR6A-9, PLZKAR6A-11, V-Line 2, V-Line 4, V-Line 6, V-Line 8, V-Line11, V-Line12, V-Line13, V-Line14, V-Line17, V-Line23, V-Line28, V-Line33, V-Line35, V-Line38, Y-112M1, Y-112R1, Y-117RS, Y-117SS, Y-162R1, Y-204RS, Y-204SS, Y-503J, Y-515J, Y-517J, Y-519J, Y-522J, Y-530J, Y-705RS, Y-707RS, Y-712RS, Y-732J, ZFR5E-11 |
| NSU | B7ES, B8ES, BR8EIX, BR9EIX |
| OPEL | B6HS, B6S, BKR5EK, BKR5EQUPA, BKR5EVX-11, BKR6E, BKR6EK, BP5ET, BP6E, BP6ES, BP6H, BP6HS, BPR5E, BPR5ES, BPR6E, BPR6ES, BPR6ES-11, BPR6H, BPR6HS, BPR7HIX, BR6S, BR7HIX, CY03, D-Power 1, D-Power 14, D-Power 18, D-Power 20, D-Power 23, D-Power 28, D-Power 3, D-Power 36, D-Power 37, D-Power 4, D-Power 42, D-Power 60, D-Power 7, D-Power 8, ILTR5D, LPG 1, LPG 2, LPG 6, LTR6B-10T, PFR5G-11, PFR6G-11, PFR6G-9, PFR6T-10G, PFR6T-G, PFR7G, PLFR6C-10G, V-Line 2, V-Line 3, V-Line 4, V-Line 6, V-Line13, V-Line18, V-Line20, V-Line23, V-Line28, Y-208T, Y-306R, Y-403T, Y-506J, Y-515J, Y-517J, Y-523J, Y-534J, Y-541J, Y-603J, Y-711J, Y-719RS1, Y-732J, Y-741U, Y-748U, Y-904M1, Y-908R, Y-910J, Y-917U, Y-924J, Y-924U, Y-935U, YE06, YE07, ZFR5F, ZFR5F-11, ZFR6F-11 |
| PANTHER | BKR6E, BPR6E, BPR6ES, BPR6FS, LPG 1, LPG 2, V-Line 2, V-Line28 |
| PEUGEOT | BCP5E, BCP5ES, BCP6E, BCP6ES, BCP6ET, BCPR5E, BCPR5ES, BCPR6E, BCPR6ES, BCPR6ET, BCPR7EIX, BCPR7ES, BKR5EK, BKR5EZ, BKR6E, BKR6E-11, BKR6EK, BKR6ES, BKR6EZ, BKUR7ET, BP5E, BP5ES, BP6E, BP6EF, BP6EFS, BP6ES, BP6ET, BP7EFS, BR7EF, D-Power 1, D-Power 10, |



| | |
|--------------------|--|
| | D-Power 24, D-Power 3, D-Power 33, D-Power 40, D-Power 56, D-Power 58, D-Power 9, LFR5B, LFR6B, LFR6C-11, LPG 1, LPG 2, LPG 3, LPG 5, LPG 7, LZKAR7A, PLFR5A-11, PLZKBR7A-G, V-Line 4, V-Line 5, V-Line 8, V-Line12, V-Line14, V-Line16, V-Line17, V-Line20, V-Line23, V-Line28, V-Line32, V-Line36, V-Line38, Y-1005J, Y-208T, Y-404, Y-503J, Y-503R, Y-504J, Y-504R, Y-731U, Y-738U, Y-8001AS, Y-810, Y-902R, Y-910J, Y-911J, Y-923U, Y-924J, Y-924U, Y-938R, YE04, YE05, YE08, YE12 |
| PIAGGIO | BKUR6EK, LPG 1 |
| PININFARINA | BP7ES, BPR6E, BPR6ES, BPR7E, BPR7ES, BPR8EIX, LPG 2, V-Line 2, V-Line19 |
| PLYMOUTH | FR45, FR5 |
| PONTIAC | BCPR6E, BCPR6ES, LPG 3, LPG 5, TR55, V-Line12 |
| PORSCHE | B6ES, B7HS, B8EGV, B8ES, B9EVX, BCPR7ET, BKR6E, BKR6EK, BKR6EQUP, BKR6ES, BKR7EIX, BKR7EKC, BKR7EQUP, BKR8EIX, BP5EVX, BP6ET, BP6H, BP6HS, BP7ES, BP7HS, BP8EVX, BPR6E, BPR6ES, BPR7E, BPR7ES, BPR7HIX, BPR7HS, BPR8EIX, BPR8EVX, BPR8HIX, BPR9EIX, BPR9EVX, BR10EIX, BR8EVX, BR8HIX, BR9EIX, IZKR7B, LPG 1, LPG 2, PFR7Q, PFR8B-9, V-Line 2, V-Line18, V-Line19, V-Line20, V-Line28, V-Line30 |
| PROTON | BKR6E-11, BPR5E, BPR5ES, BPR6E, BPR6ES, LPG 1, LPG 2, V-Line 2, V-Line 6, V-Line14 |
| PUCH | BCP6E, BCP6ES, BP6EF, BP6EFS, LPG 3, LPG 5, V-Line 5, V-Line17 |
| RENAULT | B6HS, B7HS, B8EFS, B8EG, B8EVX, B9EG, BCP5E, BCP5ES, BCP6E, BCP6ES, BCP6ET, BCPR5E, BCPR5ES, BCPR6E, BCPR6ES, BK5ESZ, BKR5EK, BKR5EVX, BKR5EZ, BKR6E, BKR6EIX, BKR6EKUB, BKR6ES, BKR6EZ, BKUR7ET, BP5E, BP5ES, BP5ESZ, BP6E, |

| | |
|--------------------|--|
| | BP6EF, BP6EFS, BP6ES, BP6ESZ, BP6H, BP6HS, BP7EFS, BP7EFVX, BP7ES, BPR5E, BPR5ES, BPR6E, BPR6EF, BPR6EFS, BPR6ES, BPR7HIX, BPR8EIX, BR7HIX, BR8HIX, BR9EIX, D-Power 1, D-Power 10, D-Power 12, D-Power 15, D-Power 17, D-Power 18, D-Power 19, D-Power 22, D-Power 25, D-Power 3, D-Power 4, D-Power 7, LFR4AP-11, LPG 1, LPG 2, LPG 3, LPG 5, LPG 7, LZKAR7A, LZKAR7B, PFR6E-10, PFR6G-9, PFR7G, PFR7Z-TG, PLFR5A-11, PLZKAR6A-11, V-Line 2, V-Line 4, V-Line 5, V-Line 6, V-Line 7, V-Line 8, V-Line12, V-Line16, V-Line17, V-Line18, V-Line23, V-Line28, V-Line32, V-Line36, V-Line38, Y-208T, Y-502R, Y-503J, Y-503R, Y-506J, Y-515J, Y-516J, Y-517J, Y-730U, Y-732J, Y-740U, Y-902R, Y-908R, Y-910J, Y-913J, Y-913M, Y-914U, Y-924J, Y-927J, Y-927R, Y-932R, Y-933J, Y-933R |
| ROLLS-ROYCE | BKR6EQUP, LPG 1, V-Line30 |
| ROVER | BCP6E, BCP6ES, BCPR6E, BCPR6E-11, BCPR6ES, BKR6E, BKR6E-11, BKR6ES, BKR7E, BKR8EIX, BP5EFS, BP5HS, BP6E, BP6EF, BP6EFS, BP6ES, BPR6E, BPR6ES, D-Power 1, D-Power 10, D-Power 17, D-Power 3, D-Power 32, D-Power 33, D-Power 9, LPG 1, LPG 2, LPG 3, LPG 5, LPG 6, PFR6N-11, V-Line 2, V-Line 4, V-Line 5, V-Line11, V-Line12, V-Line14, V-Line17, V-Line28, Y-503J, Y-507J, Y-507R, Y-730U, Y-731U, Y-902R, Y-910J, Y-911J, Y-923U, Y-924J, ZFR6F-11 |
| SAAB | BCP5E, BCP5ES, BCP5EVX, BCP6EVX, BCP7EVX, BCPR6E, BCPR6E-11, BCPR6ES, BCPR6ES-11, BCPR7EIX, BCPR7ES, BCPR7ES-11, BKR5EK, BKR5EQUPA, BKR6EK, BKR7ES-11, BKR7ESC-11, BKR8EIX, BP6E, BP6ES, BP7ES, BPR8EIX, BUR5ET-10, D-Power 14, D-Power 37, LPG 1, LPG 2, LPG 3, PFR6D10G, PFR6H-10, PFR6T-10G, PFR7H-10, PLFR6C-10G, V-Line 4, V-Line11, V-Line12, V-Line16, V-Line20, V-Line21, V-Line23, Y-523J, Y-748U, YE07 |



| | |
|------------------|--|
| SEAT | BCP7ES, BCP7ET, BKR5EKUP, BKR6ETA-10, BKUR5ET-10, BKUR6ET, BKUR6ET-10, BKUR7ET, BP5ET, BP6E, BP6ES, BP6ET, BP6H, BP6HS, BP7ES, BPR5E, BPR5ES, BPR6E, BPR6ES, BPR7HIX, BPR8EIX, BUR5ET, BUR5ET-10, BUR6ET, CZ104, CZ304, D-Power 1, D-Power 2, D-Power 20, D-Power 4, D-Power 48, D-Power 50, D-Power 52, D-Power 55, LPG 1, LPG 2, LPG 6, PFR6Q, PFR7S8EG, PZFR5D-11, PZFR5N-11T, PZFR6J-11, PZFR6R, V-Line 1, V-Line 2, V-Line 4, V-Line 6, V-Line18, V-Line21, V-Line22, V-Line24, V-Line27, V-Line34, V-Line37, Y-208T, Y-607AS, Y-732J, Y-741U, Y-902R, Y-918J, Y-918R, Y-924J, YE14, ZFR5P-G, ZFR6T-11G |
| SKODA | BCPR5E, BCPR5ES, BCPR6E, BCPR6ES, BKR6E, BKR6EKUB, BKR6ES, BKR6ETA-10, BKUR5ET-10, BKUR6ET-10, BP6H, BP6HS, BPR7HIX, BUR6ET, CZ104, CZ304, D-Power 2, D-Power 20, D-Power 31, D-Power 4, D-Power 48, D-Power 50, D-Power 52, D-Power 55, D-Power 57, LPG 1, LPG 2, LPG 3, LPG 6, PFR6Q, PFR7S8EG, PZFR5D-11, PZFR5N-11T, PZFR6R, V-Line 1, V-Line12, V-Line18, V-Line24, V-Line28, V-Line32, V-Line34, V-Line37, Y-1002AS, Y-501U, Y-607AS, Y-732J, Y-741U, Y-918J, Y-918R, YE14, ZFR5P-G, ZFR6S-Q, ZFR6T-11G |
| SMART | BKR6EKE, D-Power 46, ILZFR6C-K, LFR6C-11, LKR7B-9, LKR8A, Y-543J, YE13 |
| SSANGYONG | BCP5E, BCP5ES, D-Power 11, D-Power 6, LPG 3, V-Line16, Y-710J, Y-745U, Y-916J, Y-916R |
| SUBARU | BCPR6E-11, BCPR6ES-11, BKR5E-11, BKR6E-11, BKR6EVX, BP6E, BP6ES, BPR6E, BPR6ES, BPR6ES-11, BPR7E, BPR7ES, BPR8EIX, IFR6J-11, ILFR6B, LPG 1, LPG 2, LPG 3, LPG 7, PFR5B-11, PFR6B, PFR6B-11, PFR6G, PFR6G-11, PFR7B, PFR7G, PLFR6A-11, SILFR6A, SILFR6A11, V-Line 2, V-Line 4, |

| | |
|----------------|---|
| | V-Line11, V-Line13, V-Line14, V-Line19, V-Line33 |
| SUZUKI | BKR6E, BKR6E-11, BPR5E, BPR5ES, BPR5EY, BPR6E, BPR6ES, DCPR7E, DCPR7EVX, D-Power 1, D-Power 18, D-Power 24, D-Power 36, D-Power 39, D-Power 4, D-Power 40, IFR5E-11, IFR5J-11, IFR6E11, IFR6J-11, IKR6G-11, LPG 1, LPG 2, LPG 8, V-Line 2, V-Line 6, V-Line 9, V-Line14, V-Line28, Y-504J, Y-504R, Y-515J, Y-534J, Y-701J, Y-701R, Y-732J, Y-923U, Y-924J, Y-938R, YE04, YE06 |
| TALBOT | B8ES, BP6E, BP6EF, BP6EFS, BP6ES, BP6H, BP6HS, BP7ES, BP8ES, BPR6E, BPR6ES, BPR7HIX, BPR8EIX, BPR9EIX, BR8EIX, D-Power 1, LPG 2, LPG 5, V-Line 2, V-Line 4, V-Line 5, V-Line18, Y-902R, Y-924J |
| TOYOTA | BCPR5EIX-11, BCPR5EP-11, BCPR5EP-8, BCPR5EY, BCPR6EP-11, BCPR6EP-13, BCPR6EPN-8, BCPR6EY, BCPR6EY-11, BCRE527Y, BKR5EKB-11, BKR5EP-11, BKR5EYA, BKR5EYA-11, BKR6EKB-11, BKR6EKP-11, BKR6EP-11, BKR6EP-13, BKR6EP-8, BKR6EYA, BKR6EYA-11, BP4EY, BP5EY, BPR4EY, BPR5E, BPR5EA-L, BPR5EP-11, BPR5ES, BPR5EY, BPR5EY-11, BPR6EY, BPR6EY-11, D-Power 44, D-Power 45, HB6AIX-11P, HB6BIX-11P, IFR5T11, IFR5T-8N, IFR6T-11, ILKAR7B-11, LFR6C-11, LPG 1, LPG 2, LPG 3, V-Line 6, V-Line 9, V-Line10, V-Line39, Y-118R, Y-146R, Y-147T, Y-168R, Y-197R, Y-531J, Y-532J, Y-542J, Y-703R, Y-715R |
| TRABANT | B6HS, BP6E, BP6ES, BP6H, BP6HS, BPR7HIX, BR7HIX, LPG 2, V-Line 4, V-Line18 |
| TRIUMPH | BP5E, BP5ES, BP6E, BP6EF, BP6EFS, BP6ES, BPR5E, BPR5ES, LPG 2, LPG 5, V-Line 4, V-Line 5, V-Line 6, V-Line 8 |
| TVR | B7ECS, BCPR6E, BCPR6ES, BKR5EKU, BPR6E, BPR6ES, DCPR8E, LPG 2, LPG 3, LPG 8, V-Line 2, V-Line12 |

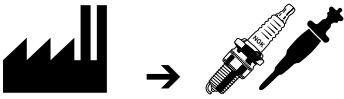

| | |
|-----------------|---|
| VAUXHALL | BK6E, BKR5EIX-11, BKR5EK, BKR6EK, BP6E, BP6ES, BP6FS, BP7ES, BPR5E, BPR5ES, BPR6E, BPR6ES, BPR6FS, D-Power 1, D-Power 14, D-Power 20, D-Power 28, D-Power 3, D-Power 36, D-Power 37, D-Power 4, D-Power 42, D-Power 7, LPG 1, LPG 2, LPG 6, LTR6B-10T, PFR5G-11, PFR6G-9, PFR6T-10G, PFR6T-G, PLFR6C-10G, V-Line 2, V-Line 4, V-Line 6, V-Line20, V-Line23, Y-307R, Y-506J, Y-517J, Y-523J, Y-534J, Y-541J, Y-603J, Y-604J, Y-710J, Y-711J, Y-719RS1, Y-732J, Y-741U, Y-748U, Y-902R, Y-904M1, Y-910J, Y-924J, Y-924U, YE06, YE07, ZFR5F, ZFR5F-11, ZFR6BP-G |
| VOLVO | B6S, BCP7EVX, BCPR6E, BCPR6ES, BCPR6ET, BCPR7ES, BKR6E, BKR6EKUB, BKR6EQUP, BKR6ES, BKR6EVX, BKR7E, BKR7EVX, BKR8EIX, BP6E, BP6EF, BP6EFS, BP6ES, BP6H, BP6HS, BP7EFS, BP7HS, BPR6E, BPR6EF, BPR6EFS, BPR6ES, BPR7E, BPR7ES, BPR7HIX, BPR8EIX, D-Power 15, D-Power 18, D-Power 2, D-Power 22, D-Power 25, D-Power 4, D-Power 40, IFR6B11, ILFR6B, ITR6F-13, IZFR6B, LFR6D, LPG 1, LPG 2, LPG 3, LPG 5, LPG 7, PFR6B, PFR6G, PFR7B, PFR7G, PLFR6A-11, TR5B-13, V-Line 2, V-Line 4, V-Line 5, V-Line 7, V-Line12, V-Line18, V-Line19, V-Line28, V-Line30, Y-515J, Y-732J, Y-740U, Y-913J, Y-913M, Y-918J, Y-918R, Y-932R, Y-933J, Y-933R, YE04, YE12, ZGR5B |
| VW | B5ES, B5HS, B6ES, B6HS, BCP7ET, BKR5E, BKR5EKU, BKR5EKUP, BKR5EVX, BKR6E, BKR6EKUB, BKR6EKUE, BKR6EQUA, BKR6ETA-10, BKUR5ET, BKUR5ET-10, BKUR6ET, BKUR6ET-10, BKUR7ET, BP5E, BP5ES, BP5ESA, BP5ET, BP6E, BP6ES, BP6ESZ, BP7ES, BPR5EKU, BPR5EY, BPR5EY-11, BPR8EIX, BR7HIX, BUR5ET, BUR5ET-10, BUR6ET, CZ104, CZ304, D-Power 2, D-Power 20, D-Power 31, D-Power 4, D-Power 48, D-Power 49, D-Power 50, D-Power 52, D-Power 55, D-Power 57, ILZKR7A, IZKR7B, LPG 1, LPG 2, LPG 6, |

| | |
|-----------------|---|
| | PFR6Q, PFR6W-TG, PFR7S8EG, PZFR5D-11, PZFR5J-11, PZFR5N-11T, PZFR6J-11, PZFR6R, V-Line 1, V-Line 4, V-Line 8, V-Line 9, V-Line21, V-Line22, V-Line24, V-Line27, V-Line28, V-Line29, V-Line34, V-Line35, V-Line37, Y-1002AS, Y-118R, Y-501U, Y-607AS, Y-609AS, Y-715R, Y-732J, Y-741U, Y-918J, Y-918R, YE14, ZFR5P-G, ZFR6S-Q, ZFR6T-11G |
| WARTBURG | A7, AB7, BP6E, BP6ES, BP6H, BP6HS, BPR7HIX, LPG 2, V-Line 4, V-Line18 |
| WIEMANN | BKR6EK, DCPR8EKP, LPG 1, PKR7A, V-Line20 |
| ZASTAVA | BP6E, BP6ES, BPR5E, BPR5ES, BPR6E, BPR6ES, LPG 2, V-Line 2, V-Line 4, V-Line 6 |
| ZAZ | BP6E, BP6ES, LPG 2, V-Line 4, |



| | |
|-----------|-----------|
| A-6 | AB-6 |
| A-7 | AB-7 |
| A-8 | AB-8 |
| A-8F | A8FS |
| A-8V | AB-8 |
| A-9F | A9FS |
| A-9V | AB-8 |
| APR5FS-11 | APR5FS |
| APR5FS-15 | APR5FS |
| APR6F | AP6FS |
| B10EV | B10EVX |
| B10FS | R5673-10 |
| B10H | B10HS |
| B10HN | R5525-10 |
| B10HP | R5530-10 |
| B10HV | B10HVX |
| B11EN | B11EGV |
| B11HN | R5525-11 |
| B11HP | R5530-11 |
| B5EB | BR5ES |
| B5EB-11 | BUR5EB-11 |
| B5ES-11 | B5ES |
| B6EB-L-11 | BR6ES |
| B6EFS | BR6EF |
| B6EMV | B6EM |
| B6ET | B6EM |
| B6EV | B6EVX |
| B6FS | BR6FS |
| B6HV | BR6HIX |
| B6HVX | BR6HIX |
| B-77-HC | B8HCS |
| B7EB | BR7ES |
| B7EB-11 | BUR7EB-11 |
| B7ET | BR7ET |
| B7EV | BR7EIX |
| B7EVX | BR7EIX |
| B7HV | BR7HIX |
| B7HVX | BR7HIX |
| B8EM | BR8EM |
| B8EMV | BR8ET |
| B8EN | B8EGV |
| B8ES-11 | B8ES |
| B8ET | BR8ET |
| B8EV | B8EVX |
| B8HN | R5525-8 |
| B8HV | B8HVX |
| B9EGP | BR9EIX |
| B9EN | B9EGV |
| B9EV | B9EVX |
| B9HCV | B9HVX |
| B9HN | R5525-9 |
| B9HP | R5530-9 |
| B9HV | B9HVX |

| | |
|--------------|-------------|
| BCP4ES | BCPR4ES-11 |
| BCP4ES-11 | BCPR4ES-11 |
| BCP5E-11 | BCPR5E-11 |
| BCP5ET | BCPR5ET |
| BCP5EV | BCP5EVX |
| BCP5EV-11 | BCPR5EIX-11 |
| BCP5EVX-11 | BCPR5EIX-11 |
| BCP5EY-11 | BCPR5EY-11 |
| BCP6E-11 | BKR6E-11 |
| BCP6EV | BCP6EVX |
| BCP6EV-11 | BCPR6EVX-11 |
| BCP6EVX-11 | BCPR6EVX-11 |
| BCP7E | BCPR7E |
| BCP7E-11 | BCPR7E-11 |
| BCP7ES-11 | BKR7E-11 |
| BCP7EV | BCP7EVX |
| BCPR4E-11 | BCPR4ES-11 |
| BCPR4ES | BCPR4ES-11 |
| BCPR5EP-11 | BCPR5EIX-11 |
| BCPR5EP-13 | BCPR5EIX-11 |
| BCPR5EVX-11 | BCPR5EIX-11 |
| BCPR6EP-13 | BCPR6EIX-11 |
| BCPR6EP-N-11 | BCPR6EIX-11 |
| BCPR6ER | BKR6EK |
| BCPR7ER | BKR6EK |
| BCPR7EVX-11 | BKR7EIX-11 |
| BCPR7EY | BCPR7E |
| BK5EKU | BKR5EKU |
| BK7EKU | BKR7EKU |
| BKR6EIX-LPG | LPG1 |
| BKUR6EQU | BKR6EQUA |
| BMR7F | BM7F |
| BP10EV | BPR10EVX |
| BP2HA | BP2HS |
| BP4EFS | TR4 |
| BP4ES-13 | BPR4ES-13 |
| BP5EA | BP4EY |
| BP5EA-11 | BP4EY-11 |
| BP5EA-L | BP5EY |
| BP5EA-L-11 | BP5EY-11 |
| BP5EJ | BPR5EY-11 |
| BP5EKN | BPR5EY |
| BP5ES-L | BP5EY |
| BP5EV | BPR5EIX |
| BP5EVX | BPR5EIX |
| BP5EVX-11 | BPR5EIX-11 |
| BP6EA | BP6EY |
| BP6EA-11 | BP6EY-11 |
| BP6EK-A | BPR6EK-A |
| BP6EKA-V | BPR6EK-A |
| BP6EKN | BPR6EKN |
| BP6EV | BP6EVX |
| BP6EVX-11 | BPR6EVX-11 |



| | |
|-------------|------------|
| BP6HV | BPR6HIX |
| BP6HVX | BPR6HIX |
| BP7E | BPR7E |
| BP7EFS-13 | BP7EFS |
| BP7EKN | BPR7EKN |
| BP7EV | BP7EVX |
| BP7EY-11 | BPR7EY-11 |
| BP7HV | BPR7HIX |
| BP7HVX | BPR7HIX |
| BP8ES-11 | BP8ES |
| BP8EV | BP8EVX |
| BP8FS | R5674-8 |
| BP8HSA | BPR8HSA |
| BP8HVX | BPR8HIX |
| BP9EV | BPR9EIX |
| BPR-2E | BPR2ES |
| BPR4ES-L-11 | BPR5ES-11 |
| BPR4FS-20 | BPR4FS-15 |
| BPR4S | BP-4 |
| BPR4S-15 | BP-4 |
| BPR5EA | BPR5EY |
| BPR5EA-11 | BPR5EY-11 |
| BPR5EA-L | BPR5EY |
| BPR5EA-L-11 | BPR5EY-11 |
| BPR5EF | BPR5EFS |
| BPR5EF-13 | BPR5EFS-13 |
| BPR5EK-A | BPR5EIX-11 |
| BPR5ES-15 | BPR5ES-13 |
| BPR5EV | BPR5EIX |
| BPR5EVX | BPR5EIX |
| BPR5EVX-11 | BPR5EIX-11 |
| BPR5S | BP5S |
| BPR5S-15 | BP5S |
| BPR6EA | BPR5EY |
| BPR6EIX-LPG | LPG2 |
| BPR6ES-N-11 | BPR6ES-11 |
| BPR6EV | BPR6EVX |
| BPR6FS-10 | BPR6FS |
| BPR6FS-15 | BPR6FS |
| BPR6HVX | BPR6HIX |
| BPR6S | BP6S |
| BPR7EVX | BPR7EIX |
| BPR7EY | BPR7EIX |
| BPR7HVX | BPR7HIX |
| BPR8EVX | BPR8EIX |
| BPR9EVX | BPR9EIX |
| BR10EV | BR10EVX |
| BR4ES-11 | BR4ES |
| BR5EB | BR5ES |
| BR5EB-11 | BUR5EB-11 |
| BR5ES-11 | BR5ES |
| BR5FS-15 | BR5FS |
| BR6EB | BR6ES |

| | |
|-------------|-----------|
| BR6EB-11 | BUR6EB-11 |
| BR6EB-L | BR7ES |
| BR6ET | B6EM |
| BR6FS-15 | BR6FS |
| BR7EB | BR7ES |
| BR7EB-11 | BUR7EB-11 |
| BR7ES-11 | BR7ES |
| BR7EVX | BR7EIX |
| BR8EV | BR8EVX |
| BR8HV | BR8HIX |
| BR8HVX | BR8HIX |
| BR9EV | BR9EVX |
| BU5EB-11 | BUR5EB-11 |
| BU6EA-11 | BUR6EA-11 |
| BU6EB-11 | BUR6EB-11 |
| BU7EA-11 | BUR7EA-11 |
| BU7EB-11 | BUR7EB-11 |
| BUEW | BUE |
| BUR5EBVX-11 | BUR5EB-11 |
| BZ8ES | BR8ES |
| C10H | R0161-10 |
| C6H | C6HSA |
| C6M | C6HSA |
| C7EH-9 | CR7EH-9 |
| C7HV | C7HVX |
| C8EHVX-9 | CR8EHVX-9 |
| C8EVX | CR8EVX |
| C8HV | C8HVX |
| C9EHVX-9 | CR9EHVX-9 |
| C9EVX | CR9EVX |
| C9H | C8HSA |
| D-12E | R2525-11 |
| D-4H | DR4HS |
| D6ES | D6EA |
| D6HS | D6HA |
| D6HV | D6HA |
| D7EV | D7EVX |
| D8EV | D8EVX |
| D8HS | D8HA |
| D8HV | D8HA |
| D9EV | D9EVX |
| DCP8EVX | DCPR8EVX |
| DP5EA-9 | DPR5EA-9 |
| DP7EV-9 | DPR7EIX-9 |
| DP8EV-9 | DPR8EVX-9 |
| DP8EVX-9 | DPR8EVX-9 |
| DP9EV-9 | DPR9EVX-9 |
| DP9EVX-9 | DPR9EVX-9 |
| DPR7EV-9 | DPR7EIX-9 |
| DPR7EVX-9 | DPR7EIX-9 |
| DPR8EV-9 | DPR8EVX-9 |
| DPR9EV-9 | DPR9EVX-9 |
| DR8EVX | DR8EIX |



| | |
|------------|------------|
| DR9EVX | DR9EIX |
| GR4VX | GR4 |
| IFR7G-11K | IFR7G-11KS |
| J10B | JR10B |
| J9B | JR9B |
| JR10A | JR10B |
| JR9A | JR9B |
| PGR6B | PGR6A-11 |
| PZFR6B | IZFR6B |
| R0045A-10 | R0045J-10 |
| R0045A-11 | R0045J-11 |
| R015-10 | R0373A-10 |
| R015-8 | CR8EIX |
| R015-9 | R0373A-9 |
| R015-95 | R0373A-10 |
| R016-10 | R0373A-10 |
| R016-105 | R0373A-9 |
| R016-11 | R0373A-11 |
| R016-8 | CR8EIX |
| R016-9 | R0373A-9 |
| R016E-11P | R0373A-11 |
| R017-10 | R0373A-10 |
| R017-11 | R0373A-11 |
| R017-8 | CR8EIX |
| R017-9 | R0373A-9 |
| R017-S11 | R0373A-11 |
| R017-S12 | R017-12 |
| R0256K-11 | R0373A-11 |
| R2097-11P | R2525-10 |
| R216-10 | R2525-10 |
| R216-11 | R2525-10 |
| R216-12 | R2525-11 |
| R216-9 | R2525-9 |
| R217-10 | R2525-10 |
| R217-11 | R2525-10 |
| R217-12 | R2525-11 |
| R217-9 | R2525-9 |
| R2198-12P | R2525-11 |
| R2270-10 | R2349-10 |
| R2270-11 | R2349-11 |
| R2270-9 | R2349-9 |
| R2430-9 | R2349-9 |
| R4118M-10 | R4118S-10 |
| R4118M-105 | R4118S-105 |
| R4118M-11 | R4118S-11 |
| R4118M-7 | R4118S-7 |
| R4118M-75 | R4118S-75 |
| R4118-M8 | R4118S-8 |
| R4118M-85 | R4118S-85 |
| R4118-M9 | R4118S-9 |
| R4118M-95 | R4118S-95 |
| R4339-10 | B10EG |
| R4339-8 | B8EG |

| | |
|------------|------------|
| R4339-9 | B9EG |
| R4452D-10 | B10EGP |
| R4452D-105 | B105EGP |
| R4452D-11 | B11EGP |
| R4452D-8 | B8EGP |
| R4452D-85 | B85EGP |
| R4452D-9 | BR9EIX |
| R4452D-95 | B95EGP |
| R4468-10 | R6725-10 |
| R4468-105 | R6725-105 |
| R4468-11 | R6725-11 |
| R4468-115 | R6725-115 |
| R4468-9 | R6725-9 |
| R4468A-10 | R6725-10 |
| R4468A-105 | R6725-105 |
| R4468A-11 | R6725-11 |
| R4468A-115 | R6725-115 |
| R4468A-9 | R6725-9 |
| R4630A-10 | R7376-10 |
| R4630A-105 | R7376-10 |
| R4630A-11 | R7376-10 |
| R4630A-8 | R7376-8 |
| R4630A-9 | R7376-9 |
| R5184-11 | R7282-11 |
| R5300A-105 | R7282A-105 |
| R5300A-11 | R7282-11 |
| R5400-10 | R7437-10 |
| R5400-7 | BCPR7EIX |
| R5400-8 | R7435-8 |
| R5400-9 | R7435-9 |
| R5540-10 | R5540F-10 |
| R5540-105 | R5540F-105 |
| R5540-95 | R5540F-10 |
| R5540B-105 | R5540F-105 |
| R5671-8 | R5671A-8 |
| R5671-9 | R5671A-9 |
| R5672-8 | R5672A-8 |
| R5672-9 | R5672A-9 |
| R5686-10 | R7436-10 |
| R5686-11 | R7436-10 |
| R5686-8 | R7436-8 |
| R5686-9 | R7436-9 |
| R5687-10 | R7436-10 |
| R5687-8 | R7436-8 |
| R5687-9 | R7436-9 |
| R5796-8 | R7436-8 |
| R5830-10 | R7436-10 |
| R5830-9 | R7436-9 |
| R6120-10 | R7282-10 |
| R6120-105 | R7282-105 |
| R6120-11 | R7282-11 |
| R6120A-10 | R7282A-10 |
| R6120A-105 | R7282A-105 |

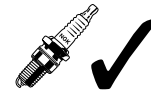

| | |
|------------|-----------|
| R6120A-11 | R7282A-11 |
| R6120C-105 | R7282-105 |
| R6120C-11 | R7282C-11 |
| R6120M-105 | R7282-105 |
| R6120M-11 | R7282M-11 |
| R6205-9 | R7433-9 |
| R6242-10 | R7434-10 |
| R6252E-8 | R7376-8 |
| R6254E-8 | R6254E-9 |
| R6255-10 | R7112-10 |
| R6255-7 | R7112-7 |
| R6255-8 | R7112-8 |
| R6255-9 | R7433-9 |
| R6326-9 | R7433-9 |
| R6385-105P | R7376-10 |
| R6385-10P | R7376-10 |
| R6385-11P | R7376-10 |
| R6385-8P | R7376-8 |
| R6385-9P | R7376-9 |
| R7112-9 | R7433-9 |
| R7113-8 | R7433-8 |
| R7113-9 | R7433-9 |
| R7114-9 | R7433-9 |
| R7115-10 | R7433-10 |
| R7115-8 | R7433-8 |
| R7115-9 | R7433-9 |
| R7116-10 | R7434-10 |
| R7116-8 | R7434-8 |
| R7116-9 | R7434-9 |
| R7117-10 | R7434-10 |
| R7117-8 | R7434-8 |
| R7117-9 | R7434-9 |
| R7118-10 | R7434-10 |
| R7118-8 | R7434-8 |
| R7118-9 | R7434-9 |
| R7119-10 | R7434-10 |
| R7119-8 | R7434-8 |
| R7119-9 | R7434-9 |
| R7232-10 | R7437-10 |
| R7232-7 | BCPR7EIX |
| R7232-8 | R7435-8 |
| R7232-9 | R7435-9 |
| R7233-10 | R7435-10 |
| R7233-7 | BCPR7EIX |
| R7234-10 | R7436-10 |
| R7234-8 | R7436-8 |
| R7234-9 | R7436-9 |
| R7236-10 | R7436-10 |
| R7236-8 | R7436-8 |
| R7236-9 | R7436-9 |
| R7238-10 | R7436-10 |
| R7238-8 | R7436-8 |
| R7238-9 | R7436-9 |

| | |
|------------|------------|
| R7239-10 | R7436-10 |
| R7239-9 | R7436-9 |
| R7279-9 | R7434-9 |
| R7282C-105 | R7282-105 |
| R7282M-105 | R7282-105 |
| R8102-10 | R8102A-10 |
| R8102-9 | R8102A-9 |
| R8108-10 | R8108A-10 |
| R8108-95 | R8108A-10 |
| RE6A-L | RE6C-L |
| RE7A-L | RE7C-L |
| RE8A-L | RE8C-L |
| SD10 | BUR9EQ |
| SD8 | BUR8EQ |
| SD9 | BUR9EQ |
| SR5 | TR5-1 |
| SR5 | TR5-1IX |
| SR5-1VX | TR5IX |
| SR5VX | TR5-1IX |
| T7341A-7 | IRITOP-7 |
| TR4-2 | TR4 |
| TR4-2 | TR4IX |
| TR4-2VX | TR4IX |
| TR55GP | TR55IX |
| TR55VX | TR55 |
| TR5VX | TR5 |
| UR40 | UR45 |
| UR5VX | UR5IX |
| WR5GP | WR5IX |
| XFR5A-11 | PFR5G-11 |
| XFR6A-11 | PFR6G-11 |
| XR40 | XR45 |
| ZF4A-11 | ZFR4F-11 |
| ZF5A-11 | ZFR5F-11 |
| ZF7A-11 | ZFR7F-11 |
| ZFR5FVX-11 | ZFR5FIX-11 |
| ZFR6FVX-11 | ZFR6FIX-11 |
| ZFR7A-11 | ZFR7F-11 |
| ZG5A | ZGR5A |
| ZTR7A | BR7EF |
| | |
| | |
| | |
| | |
| | |
| | |
| | |
| | |
| | |
| | |
| | |

PS/HP ↔ kW

| PS/HP | kW | kW | PS/HP | PS/HP | kW | kW | PS/HP |
|-------|------|-----|-------|-------|------|-----|-------|
| 1 | 1,36 | 1 | 0,736 | 1 | 1,36 | 1 | 0,736 |
| 50 | 37 | 40 | 54 | 325 | 239 | 315 | 428 |
| 55 | 40 | 45 | 61 | 330 | 243 | 320 | 435 |
| 60 | 44 | 50 | 68 | 335 | 246 | 325 | 442 |
| 65 | 48 | 55 | 75 | 340 | 250 | 330 | 448 |
| 70 | 51 | 60 | 82 | 345 | 254 | 335 | 455 |
| 75 | 55 | 65 | 88 | 350 | 257 | 340 | 462 |
| 80 | 59 | 70 | 95 | 355 | 261 | 345 | 469 |
| 85 | 63 | 75 | 102 | 360 | 265 | 350 | 476 |
| 90 | 66 | 80 | 109 | 365 | 268 | 355 | 482 |
| 95 | 70 | 85 | 115 | 370 | 272 | 360 | 489 |
| 100 | 74 | 90 | 122 | 375 | 276 | 365 | 496 |
| 105 | 77 | 95 | 129 | 380 | 279 | 370 | 503 |
| 110 | 81 | 100 | 136 | 385 | 283 | 375 | 510 |
| 115 | 85 | 105 | 143 | 390 | 287 | 380 | 516 |
| 120 | 88 | 110 | 149 | 395 | 290 | 385 | 523 |
| 125 | 92 | 115 | 156 | 400 | 294 | 390 | 530 |
| 130 | 96 | 120 | 163 | 405 | 298 | 395 | 537 |
| 135 | 99 | 125 | 170 | 410 | 301 | 400 | 543 |
| 140 | 103 | 130 | 177 | 415 | 305 | 405 | 550 |
| 145 | 107 | 135 | 183 | 420 | 309 | 410 | 557 |
| 150 | 110 | 140 | 190 | 425 | 313 | 415 | 564 |
| 155 | 114 | 145 | 197 | 430 | 316 | 420 | 571 |
| 160 | 118 | 150 | 204 | 435 | 320 | 425 | 577 |
| 165 | 121 | 155 | 211 | 440 | 324 | 430 | 584 |
| 170 | 125 | 160 | 217 | 445 | 327 | 435 | 591 |
| 175 | 129 | 165 | 224 | 450 | 331 | 440 | 598 |
| 180 | 132 | 170 | 231 | 455 | 335 | 445 | 605 |
| 185 | 136 | 175 | 238 | 460 | 338 | 450 | 611 |
| 190 | 140 | 180 | 245 | 465 | 342 | 455 | 618 |
| 195 | 143 | 185 | 251 | 470 | 346 | 460 | 625 |
| 200 | 147 | 190 | 258 | 475 | 349 | 465 | 632 |
| 205 | 151 | 195 | 265 | 480 | 353 | 470 | 639 |
| 210 | 154 | 200 | 272 | 485 | 357 | 475 | 645 |
| 215 | 158 | 205 | 279 | 490 | 360 | 480 | 652 |
| 220 | 162 | 210 | 285 | 495 | 364 | 485 | 659 |
| 225 | 165 | 215 | 292 | 500 | 368 | 490 | 666 |
| 230 | 169 | 220 | 299 | 505 | 371 | 495 | 673 |
| 235 | 173 | 225 | 306 | 510 | 375 | 500 | 679 |
| 240 | 176 | 230 | 313 | 515 | 379 | 505 | 686 |
| 245 | 180 | 235 | 319 | 520 | 382 | 510 | 693 |
| 250 | 184 | 240 | 326 | 525 | 386 | 515 | 700 |
| 255 | 188 | 245 | 333 | 530 | 390 | 520 | 707 |
| 260 | 191 | 250 | 340 | 535 | 393 | 525 | 713 |
| 265 | 195 | 255 | 346 | 540 | 397 | 530 | 720 |
| 270 | 199 | 260 | 353 | 545 | 401 | 535 | 727 |
| 275 | 202 | 265 | 360 | 550 | 404 | 540 | 734 |
| 280 | 206 | 270 | 367 | | | 545 | 740 |
| 285 | 210 | 275 | 374 | | | 550 | 747 |
| 290 | 213 | 280 | 380 | | | | |
| 295 | 217 | 285 | 387 | | | | |
| 300 | 221 | 290 | 394 | | | | |
| 305 | 224 | 295 | 401 | | | | |
| 310 | 228 | 300 | 408 | | | | |
| 315 | 232 | 305 | 414 | | | | |
| 320 | 235 | 310 | 421 | | | | |



URKUNDE

Die TecDoc Information System GmbH bestätigt hiermit, dass das Unternehmen:

NGK Spark Plug Europe GmbH

Herkulesstraße 41, 40880 Ratingen

mit den Daten der Marke/n:

NGK

für die TecDoc CATALOG Versionen 03/00 bis 02/10 die Kriterien zur Erlangung
des Qualitäts-Siegels TecDoc CERTIFIED DATA SUPPLIER erfüllt hat.



WzN, im September 2010

Ulrich Zentgraf
Geschäftsführer

Andreas Feurme
Direktor
Informations-Management-Consulting

www.tecdoc.de



www.ngk-elearning.com



www.ngk-europe.com

NGK SPARK PLUG EUROPE GMBH

Harkortstr. 41
40880 Ratingen
Germany

Tel. ++49(0)2102/974-000

Fax. ++49(0)2102/974-149

www.ngk.de



Order No. A379