

BEDIENUNGSANWEISUNG
mit Montageanweisungen

FK4550.0i

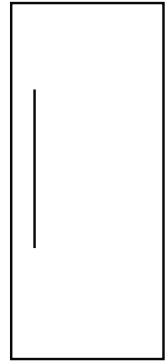

INSTRUCTIONS FOR USE
and installation

EN

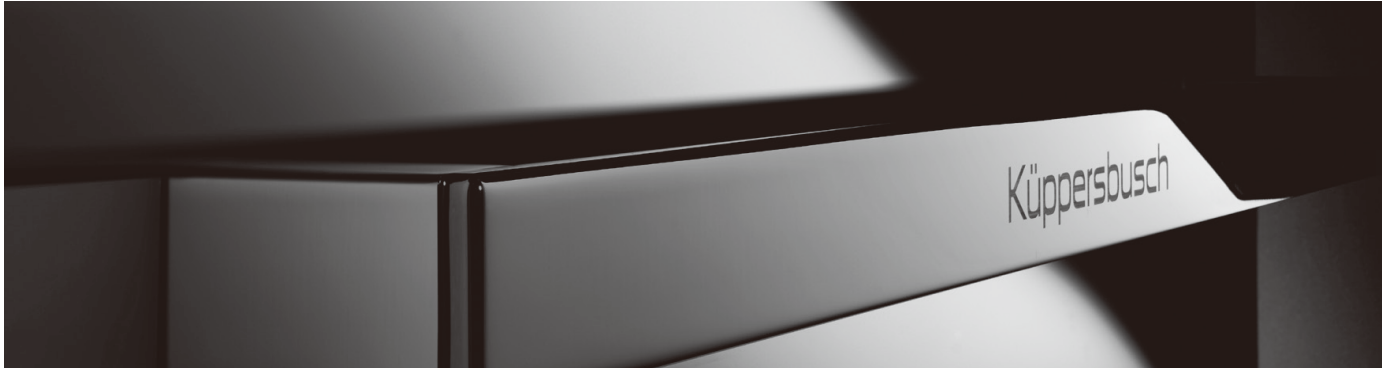

Lesen Sie unbedingt die Gebrauchsanleitung
und den Montageplan vor Aufstellung,
Installation sowie Inbetriebnahme.

Please read the users and installation
instructions carefully before installation
of the appliance and before starting to use it.

Service und Kundendienst

Telefon: 0209 – 401 631

Email: kundendienst@kueppersbusch.de

Küppersbusch
FÜR KÜCHEN MIT STIL

SUMMARY

SAFETY INFORMATION.....	2
SCRAPPING OLD APPLIANCES.....	3
Conformity.....	4
Energy Saving.....	4
Before first use.....	4
Fridge use.....	5
Freezer use.....	6
Storage.....	7
Control panel.....	8
LED light replacement instructions.....	9
Care and Cleaning;Defrosting.....	10
Troubleshooting.....	11
Installation preparation.....	12
Ventilation.....	13

Thank you for purchasing this product.

Before using your refrigerator, please carefully read this instruction manual in order to maximize its performance. Store all documentation for subsequent use or for other owners. This product is intended solely for household use or similar applications such as:
The kitchen area for personnel in shops, offices and other working environments
On farms, by clients of hotels, motels and other environments of a residential type
At bed and breakfasts(B&B)

For catering services and similar applications not for retail sale.

This appliance must be used only for purposes of storage of food, any other use is considered dangerous and the manufacturer will not be responsible for any omissions. Also, it is recommended that you take note of the warranty conditions.

SAFETY INFORMATION



Warning; Risk of fire / flammable materials

This appliance is not intended for use by persons (including children) with reduced physical, sensory or mental capabilities, or lack of experience and knowledge, unless they have been given supervision or instruction concerning use of the appliance by a person responsible for their safety.

Children should be supervised to ensure that they do not play with the appliance.

If the supply cord is damaged, it must be replaced by the manufacturer, its service agent or similarly qualified persons in order to avoid a hazard.

WARNING: Keep ventilation openings, in the appliance enclosure or in the built-in structure, clear of obstruction.

WARNING: Do not use mechanical devices or other means to accelerate the defrosting process, other than those recommended by the manufacturer.

WARNING: Do not damage the refrigerant circuit.

WARNING: Do not use electrical appliances inside the food storage compartments of the appliance, unless they are of the type recommended by the manufacturer.

WARNING: When positioning the appliance, ensure the supply cord is not trapped or damaged.

WARNING: Do not locate multiple portable socket-outlets or portable power supplies at the rear of the appliance.

Do not store explosive substances such as aerosol cans with a flammable propellant in this appliance.

This appliance is intended to be used in household and similar applications such as

- staff kitchen areas in shops, offices and other working environments;
- farm houses and by clients in hotels, motels and other residential type environments;
- bed and breakfast type environments;
- catering and similar non-retail applications.

Please according to local regulations regarding disposal of the appliance for its flammable refrigerant and blowing gas.

If the LED lamp is damaged, it must be replaced by the manufacturer, its service agent or similarly qualified persons in order to avoid a hazard

WARNING: To avoid a hazard due to instability of the appliance, it must be fixed in accordance with the instructions

SCRAPPING OLD APPLIANCES



This appliance is marked according to the European directive 2012/19/EU on Waste Electrical and Electronic Equipment (WEEE).

WEEE contains both polluting substances (which can cause negative consequences for the environment) and basic components (which can be re-used). It is important to have WEEE subjected to specific treatments, in order to remove and dispose properly all pollutants, and recover and recycle all materials.

Individuals can play an important role in ensuring that WEEE does not become an environmental issue; it is essential to follow some basic rules:

- WEEE should not be treated as household waste;
- WEEE should be handed over to the relevant collection points managed by the municipality or by registered companies. In many countries, for large WEEE, home collection could be present.

In many countries, when you buy a new appliance, the old one may be returned to the retailer who has to collect it free of charge on a one-to-one basis, as long as the equipment is of equivalent type and has the same functions as the supplied equipment.

Conformity

By placing the  mark on this product, we are confirming compliance to all relevant European safety, health and environmental requirements which are applicable in legislation for this product.

Energy Saving

For better energy saving we suggest :

- Installing the appliance away from heat sources and not exposed to direct sunlight and in a well ventilated room.
- Avoid putting hot food into the refrigerator to avoid increasing the internal temperature and therefore causing continuous functioning of the compressor.
- Do not excessively stuff foods so as to ensure proper air circulation.
- Defrost the appliance in case there is ice to facilitate the transfer of cold.
- In case of absence of electrical energy, it is advisable to keep the refrigerator door closed.
- Open or keep the doors of the appliance open as little as possible
- Avoid adjusting the setting to temperatures too cold.
- Remove dust present on the rear of the appliance

Before first use

You must allow the fridge to settle for at least four hours prior to switching the power on.

It is recommended that you clean the interior of the appliance prior to first use, using a solution of bicarbonate of soda and warm water and then thoroughly drying the interior. The fridge may have an odor to it at first use. This will disappear as the appliance cools.

Please note:

The appliance will start 5°C for fridge and -18°C for freezer and work continuously until it comes down to the correct temperature. If the appliance is switched off, you should allow five minutes before switching it on again to prevent unnecessary damage to the compressor. Never store inflammable or explosive items and strong corrosive acids or alkalis in the appliance. This fridge cools your food by making the inside back of the cavity cold. It is normal for frost to build up on this surface; it then dissipates and drains through a small drain at the bottom, where it evaporates harmlessly. The presence of frosting at the back is not a malfunction of the fridge.

Fridge use

- Never put liquids in the refrigerator uncovered.
- Never put hot foods in the refrigerator. Warm food should be allowed to cool to room temperature before being put into the refrigerator.
- Nothing should rest against the rear wall of the refrigerator, as this will cause frost and possible condensation problems which will be difficult to remove.
- Make sure food is clean and any extra water is wiped away before putting into the fridge.
- Wrap or cover food before putting into the fridge. This will help prevent the loss of moisture, keep food fresh and avoid unpleasant odors.
- Sort foods prior to storing. Any foods to be used soon should be stored at the front of the shelf to prevent deterioration caused by the door being open for prolonged periods.
- Do not overfill the fridge. There should be sufficient space between the foods to allow the cool air to circulate.
- Thawing frozen foods in the fridge compartment will help to keep the temperature low and save energy.
- Never store raw meats on shelves above cooked meats or other produce. This will help to prevent juices from raw meat contaminating other foodstuffs.

Freezer use

- The freezer compartments are designed to store only frozen food.
- Never put hot or warm foods in the freezer, allow them to cool fully before putting them into the freezer.
- Follow the instructions on the food packaging for storage of frozen food. If no information is provided, foods should not be stored for more than three months after the purchase date.
- Store food in small packages (ideally less than 1kg). This reduces the freezing time and improves the quality of the food after thawing.
- Wrap food before putting into the freezer. To stop the wrapping sticking together, ensure it is dry.
- Label the food before freezing with information including type of food and dates of storage and expiry.
- Once food is thawed, it must not be refrozen. Only defrost as much food as is required to prevent wastage.
- Bottled or canned drinks should not be stored in the freezer compartments as they could explode.
- Do not attempt to freeze more than the maximum amount.

Storage

The fridge section is for short term food storage. Although low temperatures can be maintained, extended periods of food storage is not recommended.

As the cold air circulates within the fridge, the temperature can vary between the different sections. As such, foods should be stored in different sections according to type.

1. Butter, cheeses etc.
2. Food in jars and bottles
3. Drinks, egg, milk
4. Cooked foods, Yogurts, preserves etc.
5. 75cl bottles or ready meals etc.
6. Fruit and vegetables
7. Fresh meat and fish/fruit and vegetables

The fridge shelves can be moved according to the storage requirements within the fridge section. To move the shelf, lift up the rear section and then pull it outwards.





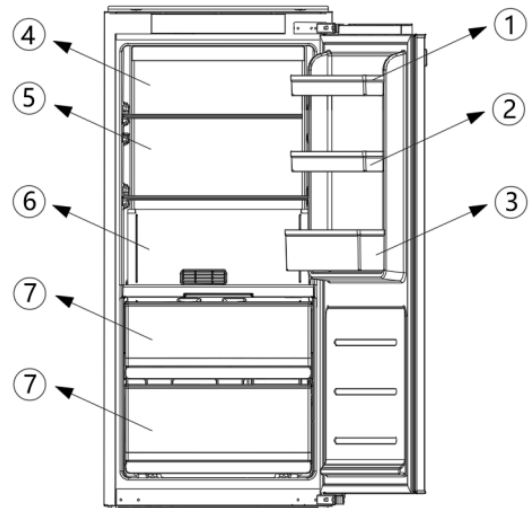



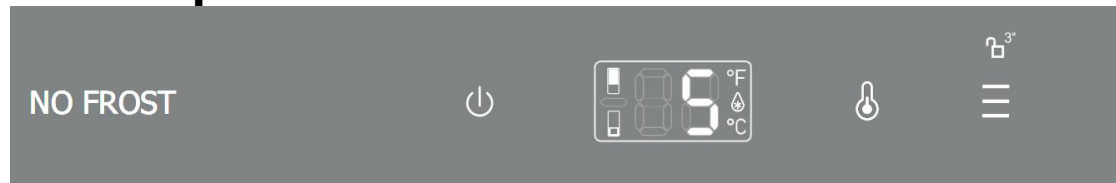

To replace, slide the shelf back into the slot, and then lower the rear section.

The most energy-saving configuration requires drawers, food box and shelves to be positioned in the product, please refer to the above pictures.



Control panel:



1. After the power is firstly turned on or restarted after power failure, the fridge compartment will work at 5 °C, the chill compartment will work at 0 °C; and if manual adjustment is required to change temperature or functions, press the  button for 3 seconds to unlock; and the control panel will be re-locked after 30 seconds without operation.
2. Fridge compartment temperature adjustment: The temperature is cycled between "2, 3, 4, 5, 6, 7, 8, fast cooling". While the control panel is unlocked, press the  button to select the fridge compartment (the upper left indicator of the display panel is on).
3. Press the  button to set the desired temperature. When fast cooling is set (the water drop indicator on the right of the display panel is on) .The fridge compartment will work on 2 °C for 24 hours continuously, and then the fast cooling is stopped and the temperature set is returned to the previous one.
4. Chiller Zone drawer adjustment function: The temperature is cycled between "0, 1, 2, 3, 4, 5". When the control panel is unlocked, press the  button to select the chill compartment (the lower left indicator of the display panel is on) Press the  button to set the desired temperature.
5. Power switch: Press the above  button for 3 seconds to switch on/off the power supply.
6. Celsius and Fahrenheit temperature switch: Press the power switch  1 time, then press  button 2 times immediately ,Celsius °C and Fahrenheit °F temperature switch is displayed, and corresponding indicators are on.
7. Sabbath mode on/off: Press the power switch  1 time, then press  button 2 times immediately
8. This product has a door-open alarm function: when the door is opened for more than 2 minutes, the buzzer begins to send a "di-di-di" alarm sound; the alarm will be sent every 1 minute; when the door is opened for more than 5 minutes, the buzzer continuously sends a "di-di-di" alarm sound.Press any button to dismiss the alarm.

Fault Display and Alarm

This product has fault alarm function. When the refrigerator sensor fails, the temperature display area will display different fault causes: "F2" (chill compartment sensor failure), "F3" (fridge compartment sensor failure), "F1" (defrost sensor failure), "CE" (main control board and display board communication failure). At these situations, the refrigerator can still work, but you should contact the after-sales as soon as possible for repair.

"2E" (refrigeration fan motor failure): at this situation the refrigerator may not be working, you should contact after-sales for maintenance as soon as possible.

POSITION	CONDITIONS
5 °C/-18°C	Summer or ambient temperature between 25°C - 35°C
5 °C/-18°C	Spring or ambient temperature between 15°C - 25°C
5 °C/-18°C	Winter or ambient temperature between 5°C - 15°C
Super freezing function	Quick freeze
Super cooling function	Super cooling

LED light replacement instructions

Note: the LED light is set to be non replaceable by the user and needs to be replaced by professionals.

Lighting parameters: 12V

1. Unplug the power plug.
2. Remove the aluminum alloy trim strip on the top of the LED surface light source, and then remove the left and right fixing screws.
3. Steps ① and ② are shown below.
4. Replace the spare LED light board.
5. Replace the aluminum alloy trim strip in turn.

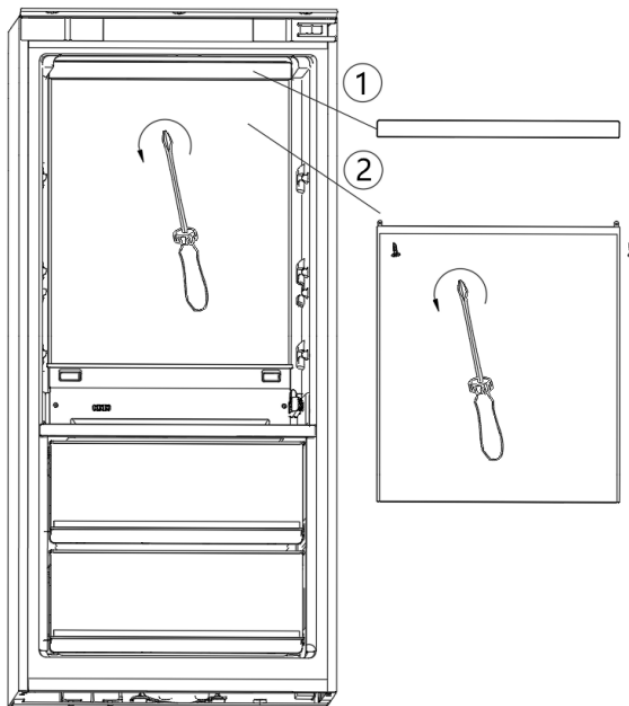

Care and Cleaning

Always disconnect the appliance from the power supply before any cleaning or maintenance.

The fridge and freezer sections should be cleaned using a solution of bicarbonate of soda and lukewarm water. Do not use abrasive products or detergents. After washing, rinse and dry thoroughly.

Clean the shelves and balconies separately by hand with a mild solution of washing up liquid and water. Do not put them in the dishwasher.

If the appliance is not to be used for prolonged periods of time, unplug and clean the appliance. The doors should be left slightly ajar to prevent the formation of mildew and unpleasant odors.

Defrosting

The product has a no frost system which is designed to prevent the heavy build up of ice. Under normal use, there should be no need to regularly defrost the freezer system.

Please note: If you are regularly finding a heavy build up of ice, or pools of water, in the freezer section then it is likely that the door is not sealing properly. This could be due to a defective door seal or an incorrectly fitted, or overly heavy, door. For more information see the troubleshooting section about ice.

Troubleshooting

If you have any problems with your appliance, you should check the troubleshooting prior to calling Customer Care.

If the appliance is not working, check:

- That there is power to the appliance.
- The house fuses are intact and the fuse in the plug has not blown.
- The fridge has not been turned off.
- The plug socket is functioning fine. To check this, plug another electrical appliance in to see if the socket is faulty.

If the appliance is working, but not very well, check:

- The appliance is not overloaded.
- The thermostat is set to an appropriate temperature.
- The doors are closing properly.
- The cooling system at the rear of the appliance is clean and free of dust, and not touching the rear wall.
- There is enough ventilation at the side and rear walls.

If the appliance is noisy, check:

- The appliance is level and stable.
- The side and rear walls are clear, and there is nothing resting on the appliance.
- Note: The cooling gas in the refrigerator may make a slight bubbling or gurgling noise, even when the compressor is not running.

If the appliance is beeping, check:

- That the doors are closed. An alarm will sound after 60 seconds of a door being open.

If ice has formed on the back wall of the fridge:

- It is normal for some ice droplets to form on the back wall of the fridge. This does not constitute a fault with the appliance.
- Ensure that no items inside the fridge are in contact with the back wall.

- Check that there is some resistance when opening the door of the appliance. If it opens at the slightest touch it may mean that the door seal needs to be replaced.
- Check the door seal for any kinks, debris or damage. If you notice any, and are unable to resolve the issue yourself, contact Customer Care so that the seal can be replaced.
- This can be due to the decor door(s) not being properly fitted. If you are at all unsure, ask your fitter to check the décor doors.

If excessive ice has formed in the freezer:

- Check that there is some resistance when opening the door of the appliance. If it opens at the slightest touch it may mean that the door seal needs to be replaced.
- Check the door seal for any kinks, debris or damage. If you notice any, and are unable to resolve the issue yourself, contact Customer Care so that the seal can be replaced.
- This can be due to the decor door(s) not being properly fitted. If you are at all unsure, ask your fitter to check the decor doors.

If one or more of the LED units within the appliance is not working:

- Contact Customer Care to arrange a service visit.

Installation preparation

This appliance must never be installed close to heat sources, e.g. heating elements or cookers, nor in damp places.

Seek the help of another individual, or two, when installing this appliance. This appliance may have sharp edges. Wear adequate PPE for the task and environment.

- To ensure the appliance is level, you should use the height adjustable feet at the front of the appliance.
- The cooling system at the rear of the appliance must not touch the rear wall. The greater the gap, the better.
- The appliance must be installed with adequate ventilation. Ensure that there is clearance above the appliance to allow air to escape and that there is space between the rear of the appliance and the wall.

Ventilation

The main consideration when installing any refrigeration unit into a fitted kitchen is ventilation. The heat removed from the cooling compartment needs to be dissipated into the atmosphere. Incorrect ventilation can lead to premature compressor failure, excessive power consumption, total system failure and may invalidate the warranty provided with the appliance. For products intended to be installed into a tall housing unit, the following requirements need to be met:

Do not tilt beyond 40°

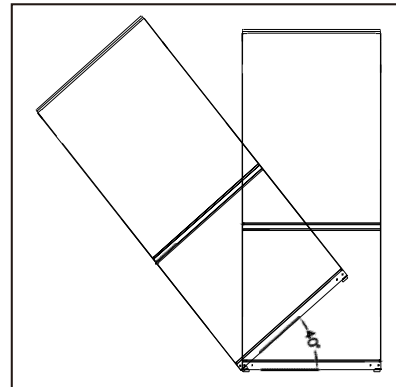

An air intake should be provided somewhere in the cabinet run to allow free air in. In this example, a plinth vent is shown underneath the refrigerator.

A cutout should be made in the plinth below the fridge/freezer and this finished neatly using the air vent grille.

Alternatively, a thin section of the plinth can be removed to allow air into the unit (recommended 500mm x 40mm)

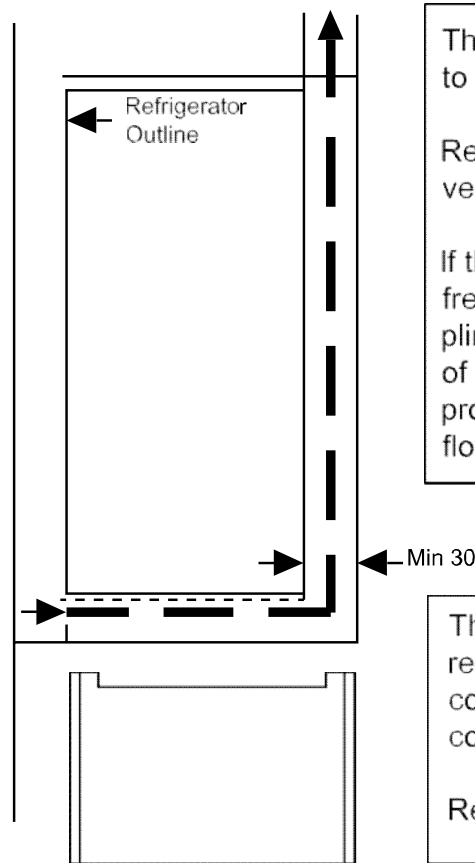

Top view of rear vent

The top of the cabinet needs to be vented into the room.

Recommended size of vent opening: 500 x 40mm.

If the furniture does not allow free air into the room then a plinth vent, or other means of ventilation needs to be provided to ensure a natural flow of air.

There should be space at the rear of the cabinet to allow cool air to be drawn over the condenser.

Recommended: 500 x 40mm

The open channel at the rear is clearly shown. For the correct operation of the appliance it is important that the top of the housing unit is not blocked off. A channel depth of 40-50mm is normal with most units. A ventilation hole is required in the plinth of the unit; this allows air to be drawn over the compressor & heat exchange.

As a rule, the more air that can get in and out, the better and more efficient the operation of the product

Ensuring the door seals correctly:

It is normal for the seal to be compressed after the door has been reversed. With the door closed, use a hair dryer to expand the seal and fill the gap between the door and the body of the appliance. Take care not to use the hair dryer too close to the appliance, which could damage the seal. A distance of approximately 10cm should be adequate. When completed, allow the seal and door to cool before touching them. Once done, the seal should remain in position.

Küppersbusch

Küppersbusch Hausgeräte GmbH

Im Welterbe 2, D-45141 Essen

Telefon: (0209) 401-0

www.home-kueppersbusch.com

