

120 min

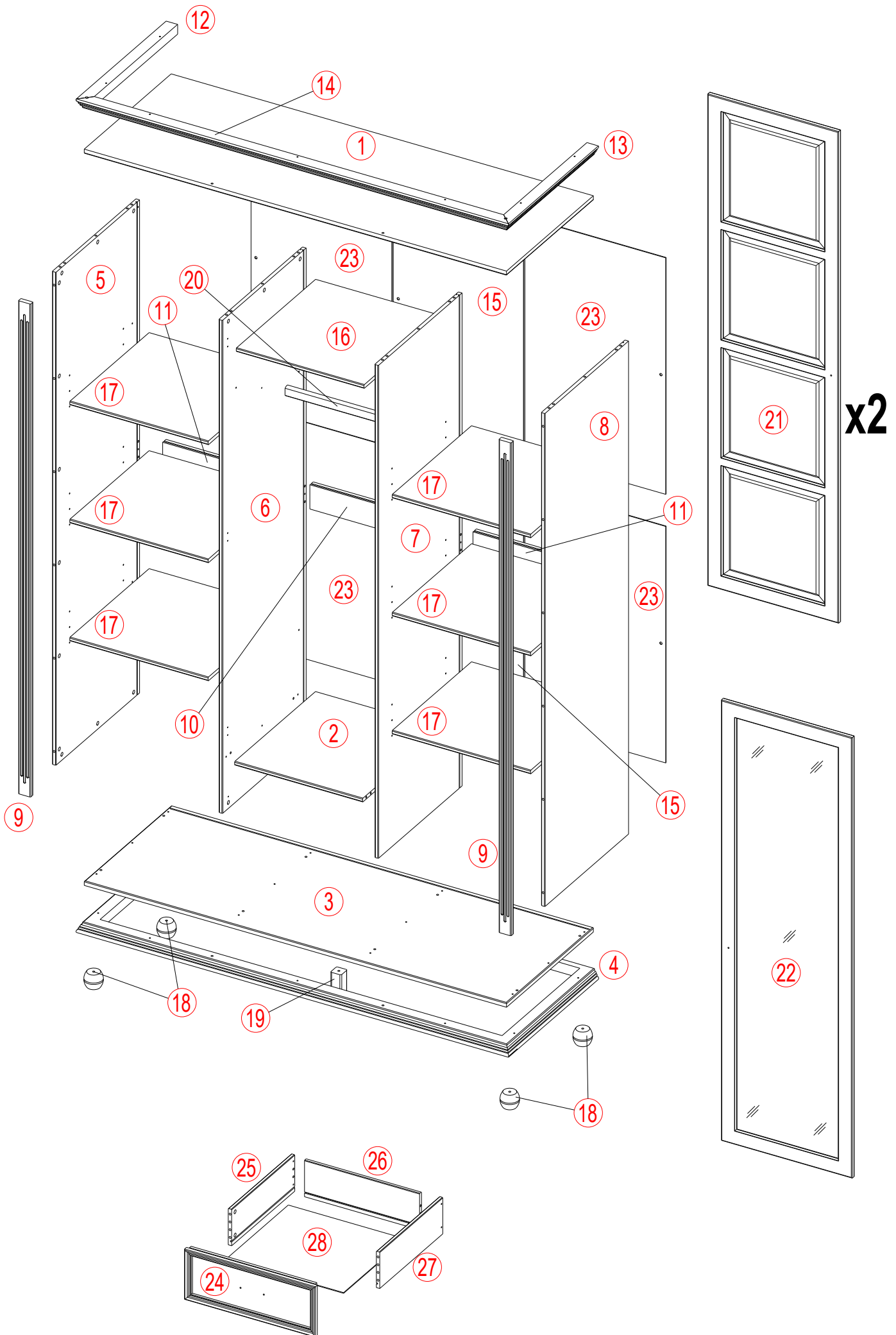

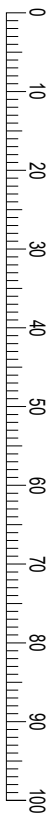
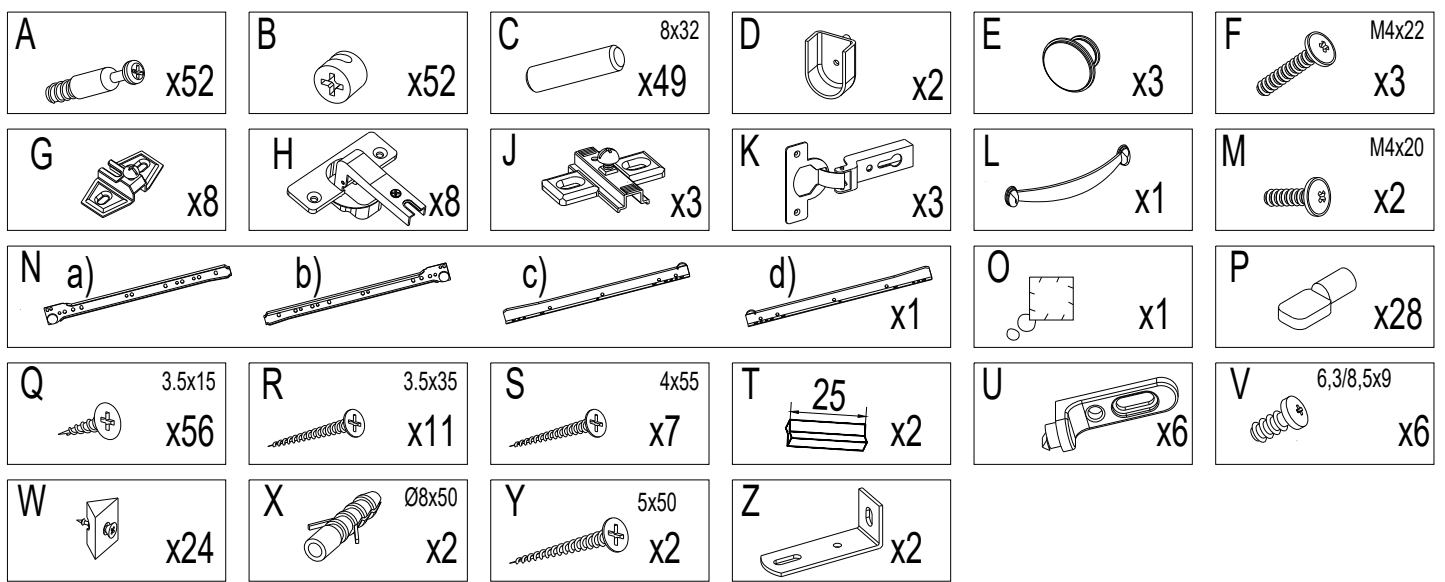

No	Size/MaB (mm)	Qty	Colli No	✓	No	Size/MaB (mm)	Qty	Colli No	✓
1	1739x620x18	1	1/4		15	974x536x3	2	1/4	
2	527x577x15	1	1/4		16	526x566x15	1	1/4	
3	1739x620x18	1	1/4		17	570x566x15	6	2/4 3/4	
4	1782x642x40	1	1/4		18	60x70x70	4	1/4	
5	2030x597x15	1	3/4		19	100x54x54	1	1/4	
6	2030x597x15	1	2/4		20	521x40x24	1	1/4	
7	2030x597x15	1	2/4		21	2024x539x18	2	4/4	
8	2030x597x15	1	3/4		22	1814x539x18	1	4/4	
9	2030x50x18	2	4/4		23	974x580x3	4	2/4 3/4	
10	527x100x24	1	1/4		24	539x207x33	1	1/4	
11	571x100x24	2	1/4		25	450x150x14	1	1/4	
12	642x48x40	1	1/4		26	474x150x14	1	1/4	
13	642x48x40	1	1/4		27	450x150x14	1	1/4	
14	1782x48x40	1	1/4		28	483x442x3	1	1/4	

1

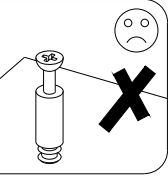
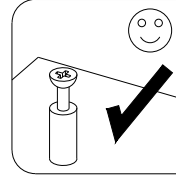
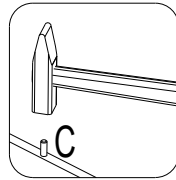
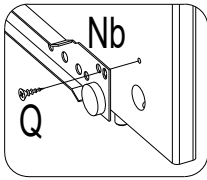
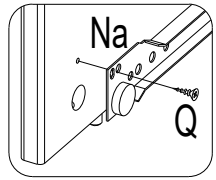
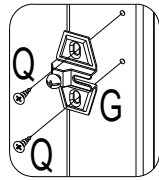
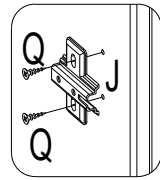
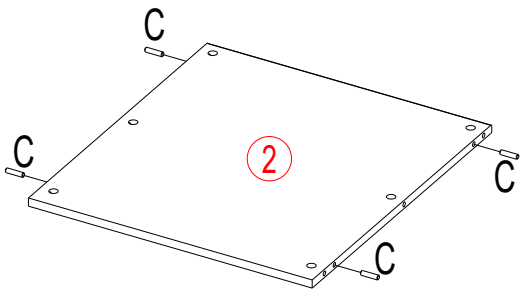
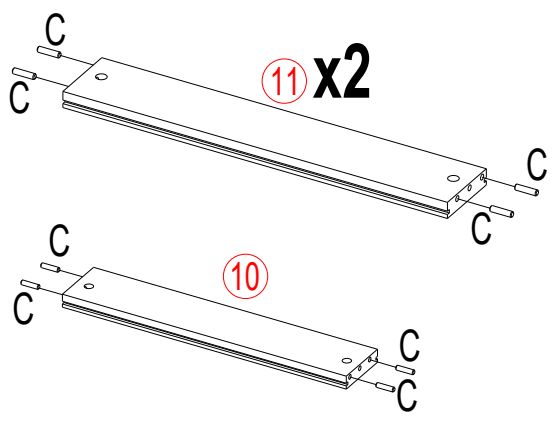
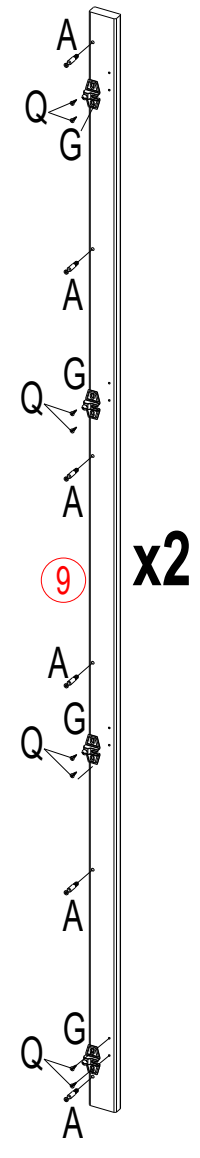
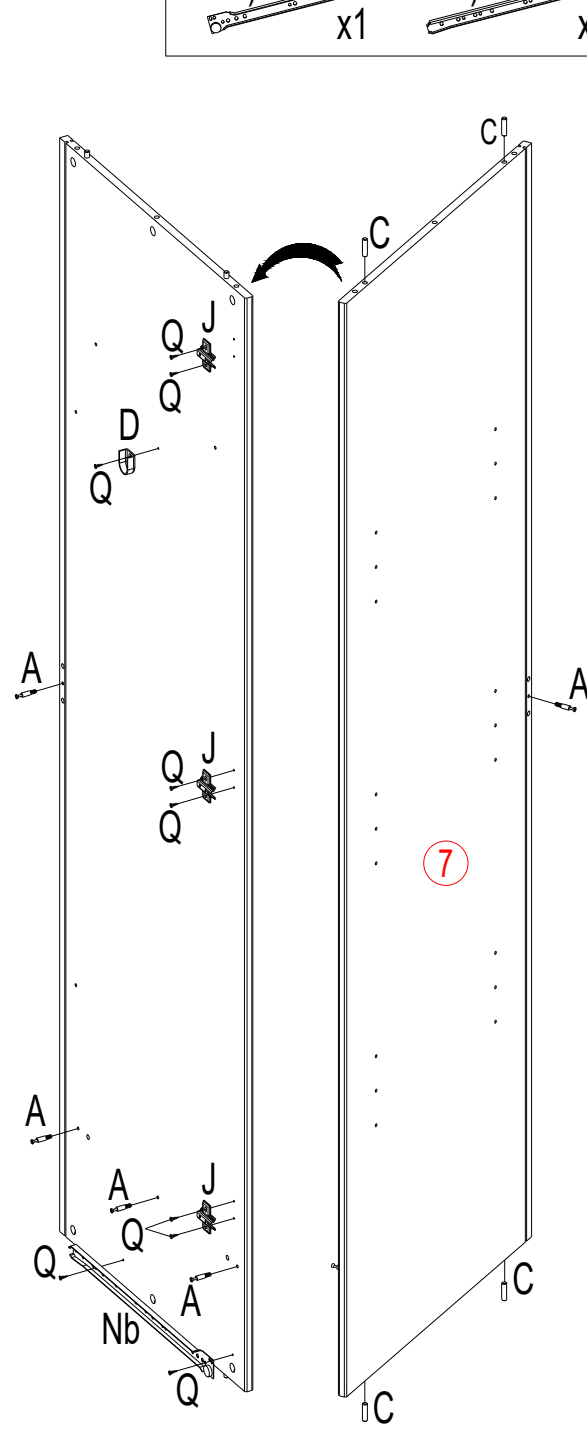
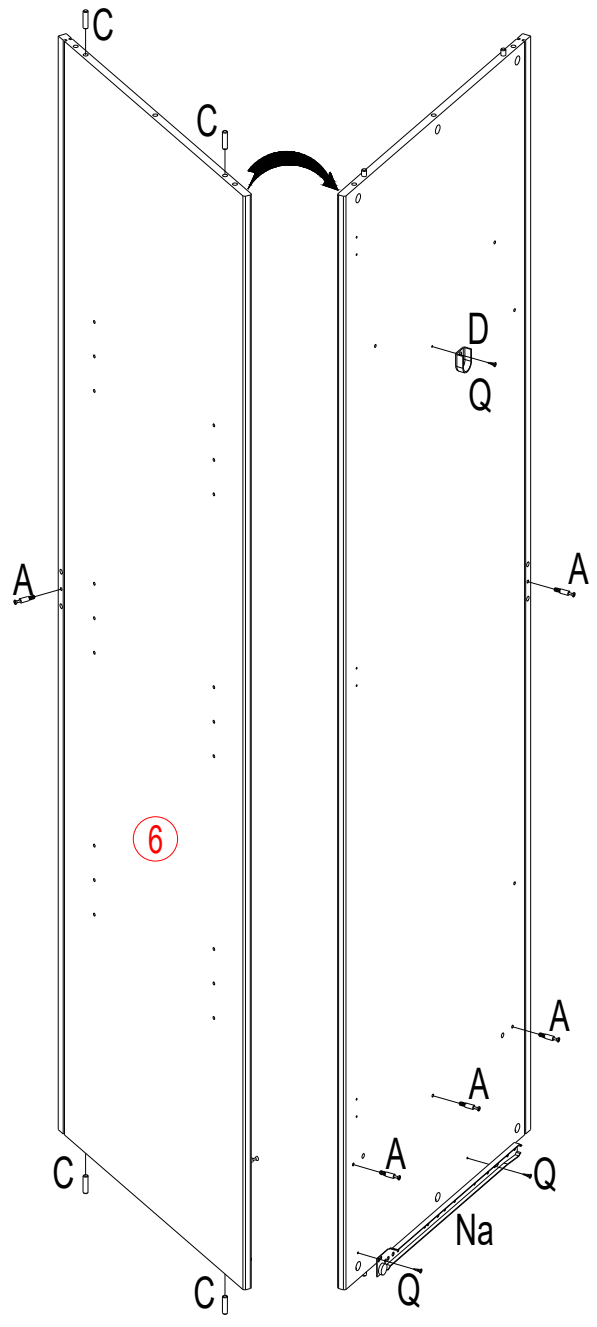
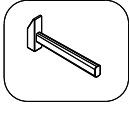
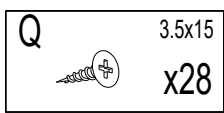
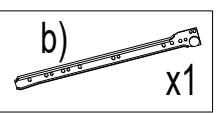
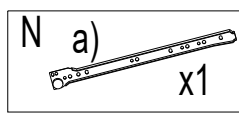
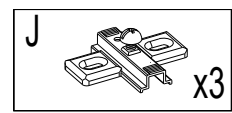
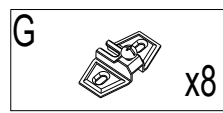
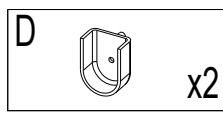
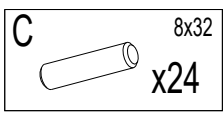
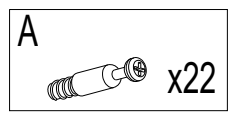

2

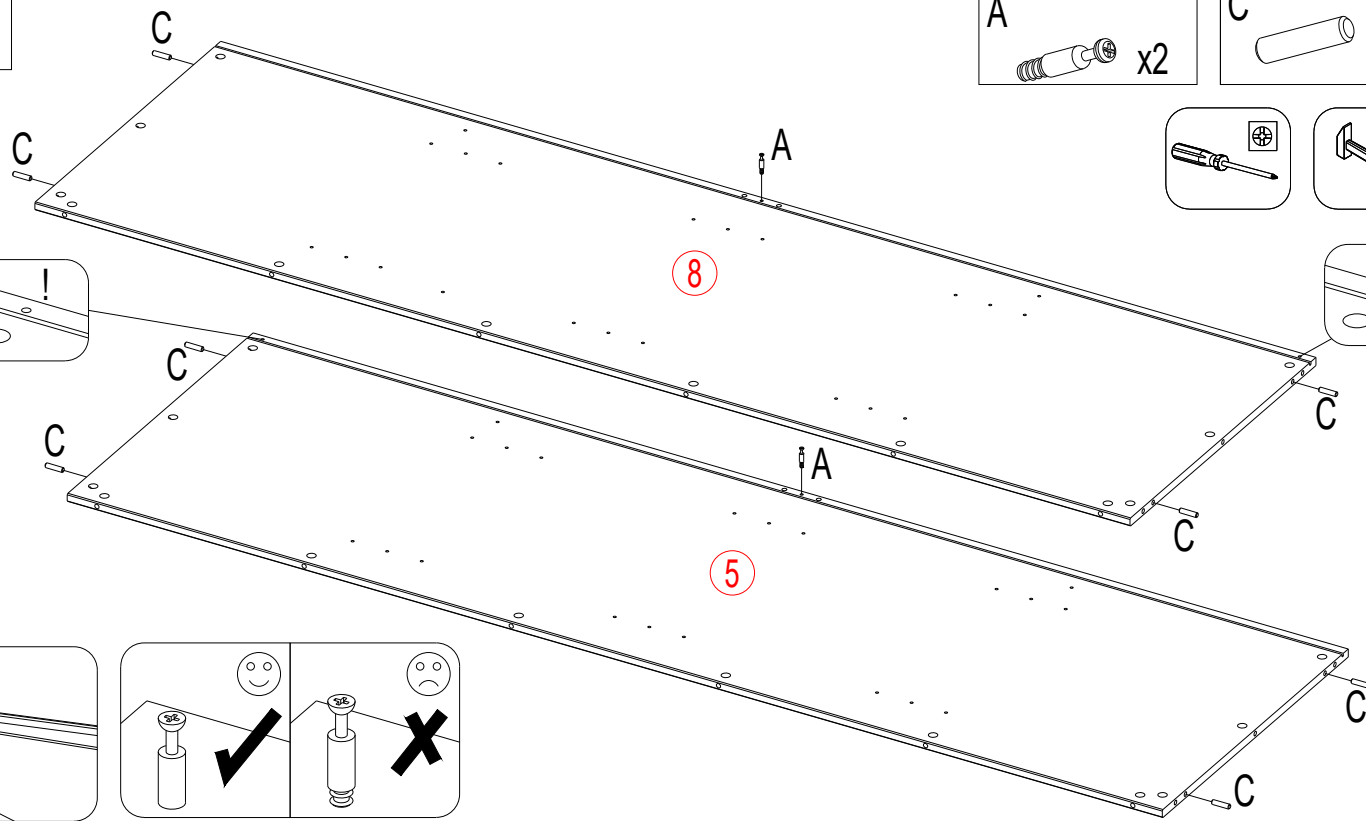
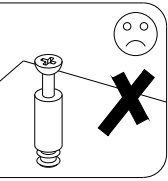
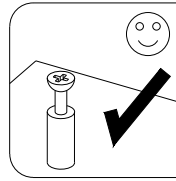
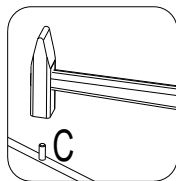
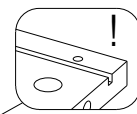
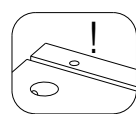
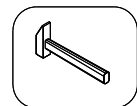
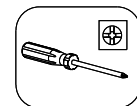
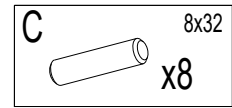
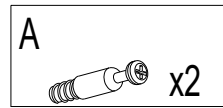

3

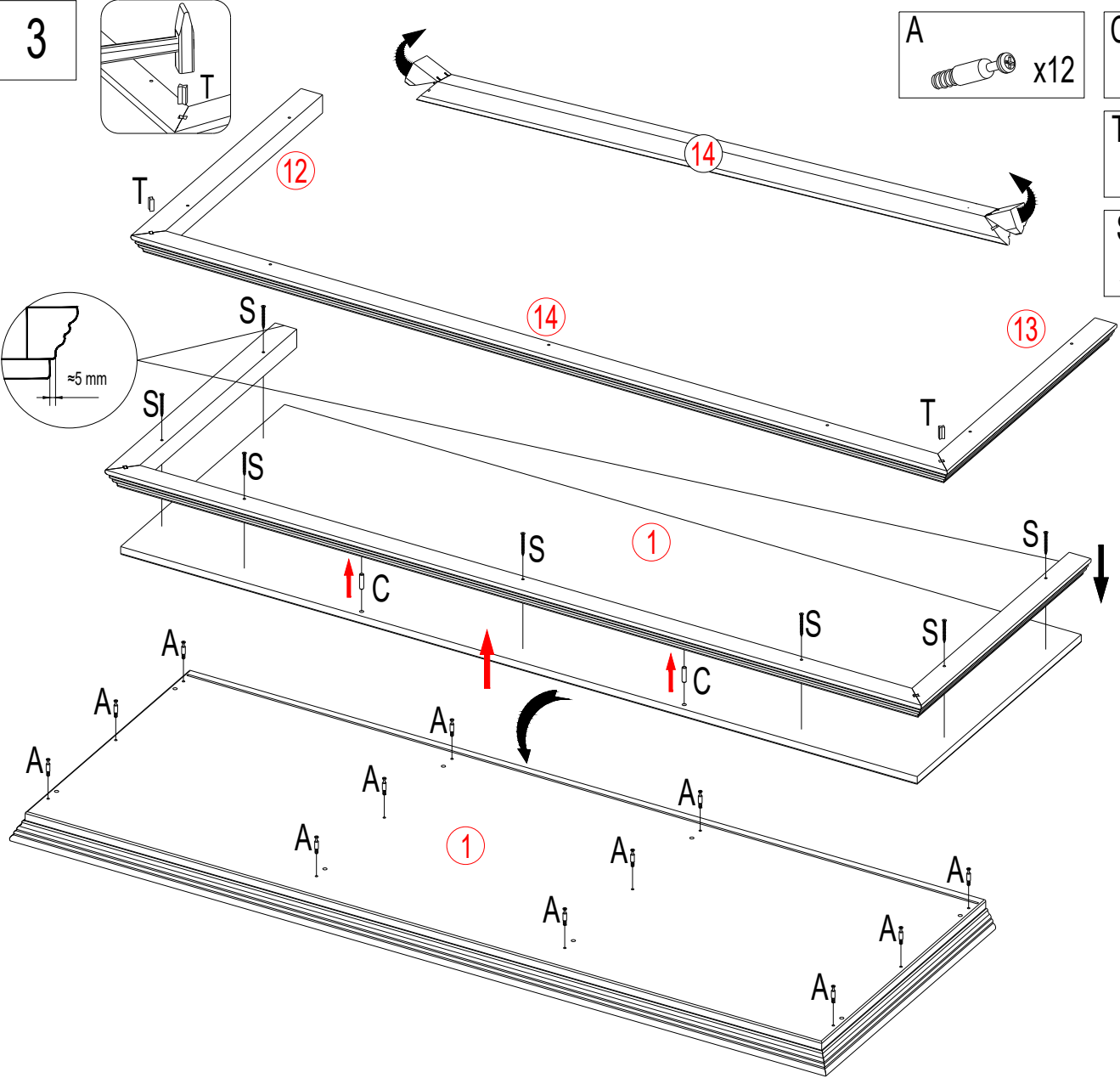
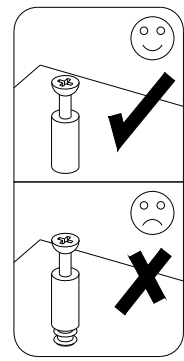
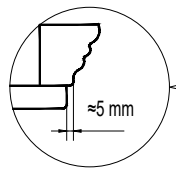
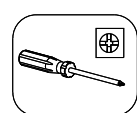
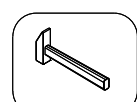
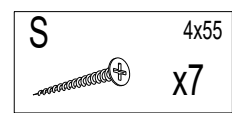
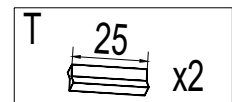
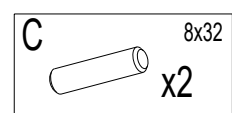
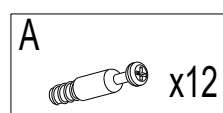
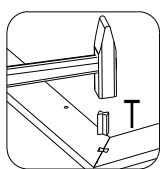

4

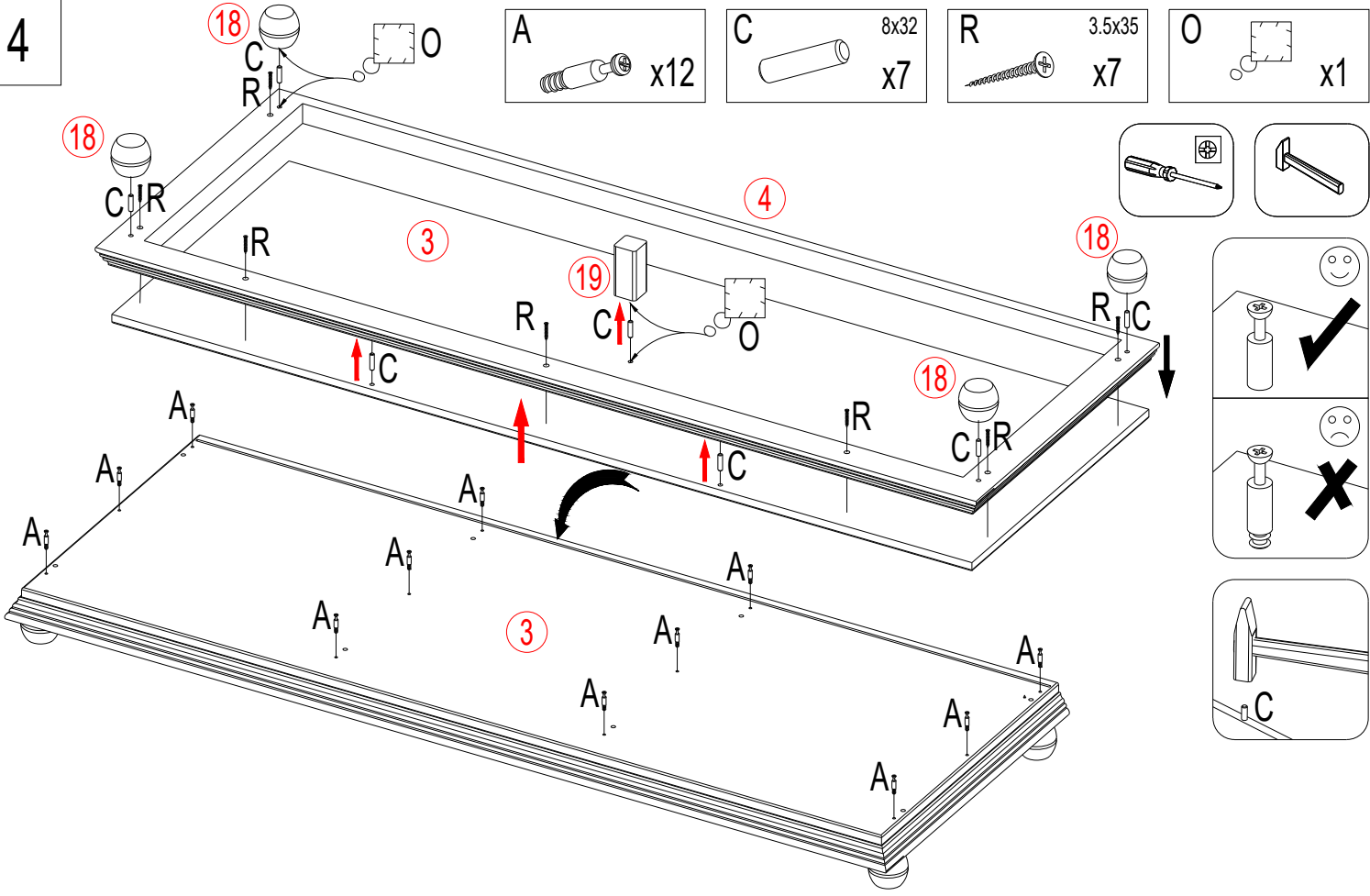

5

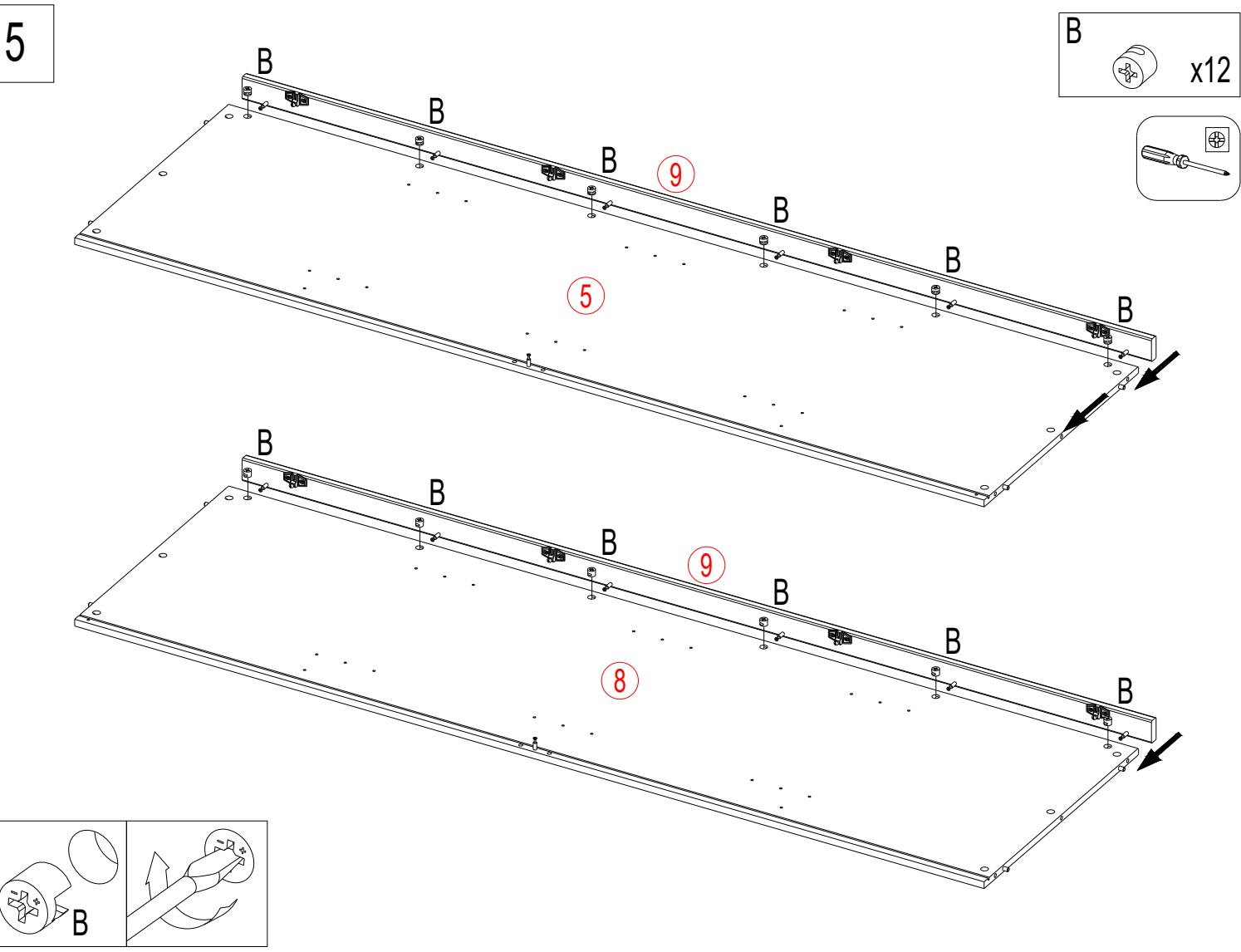

6

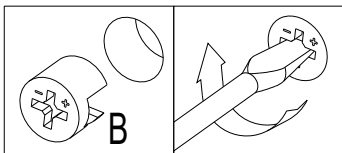
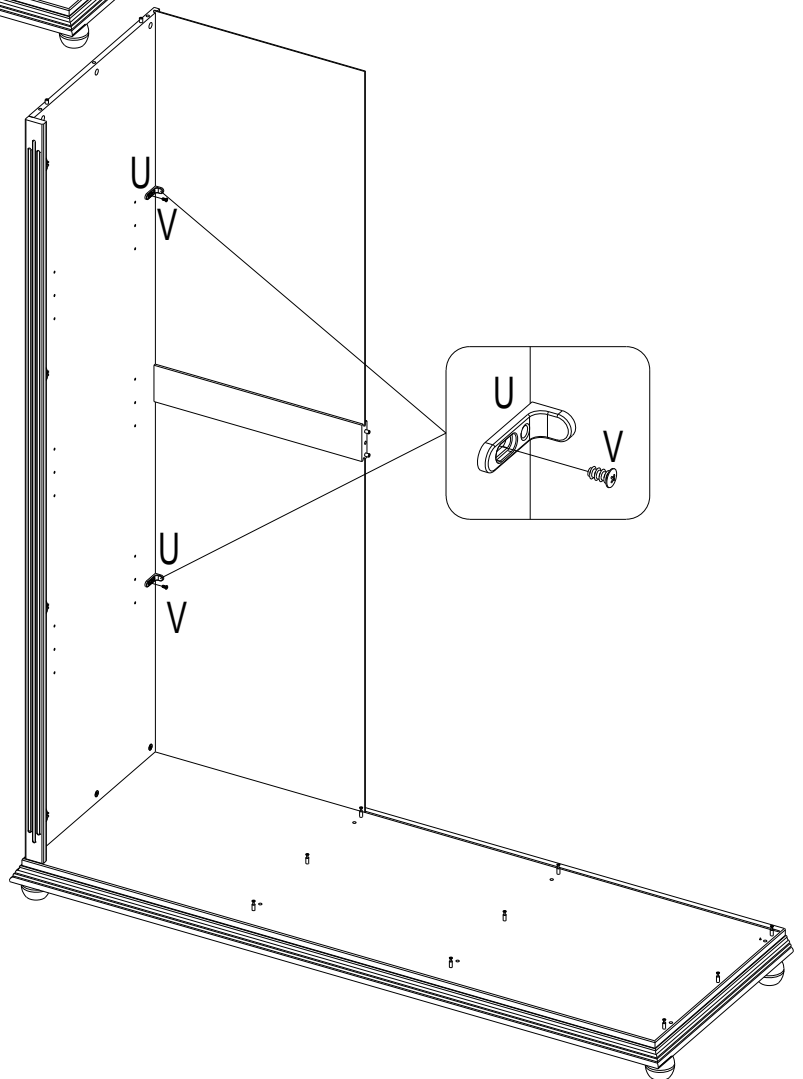
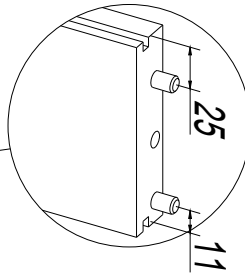
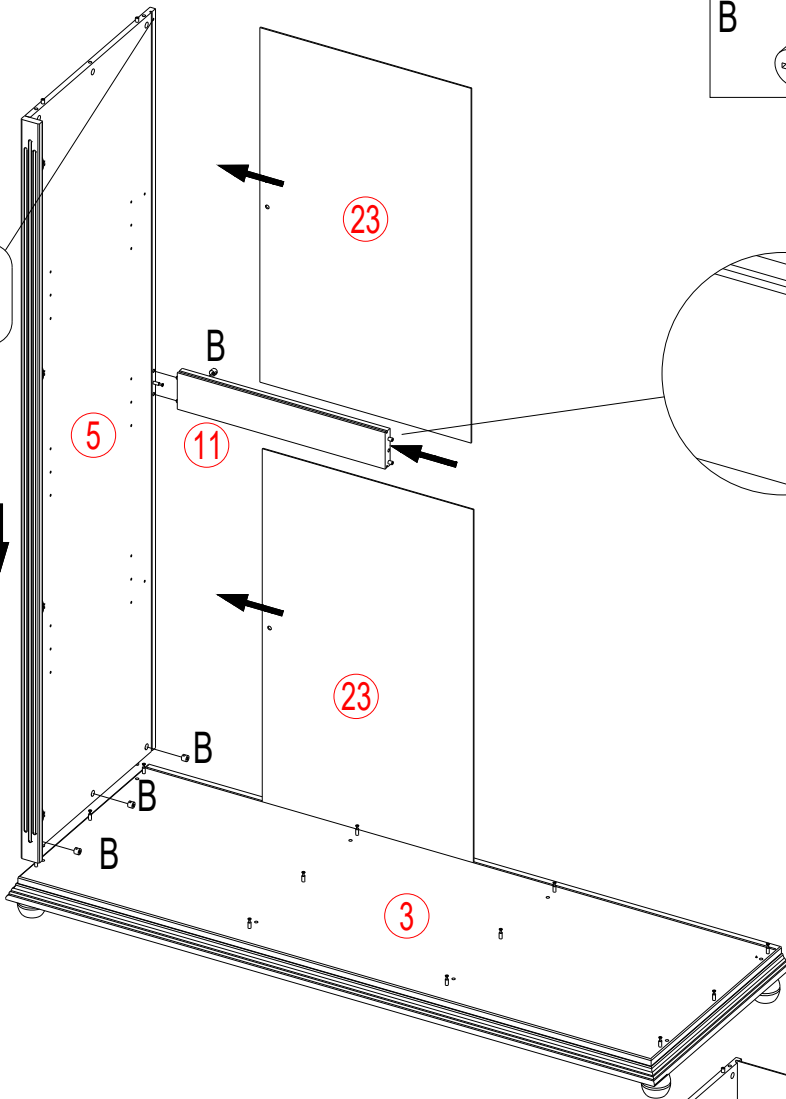
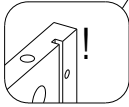
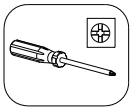
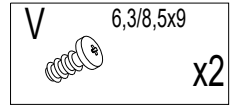
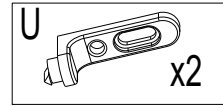
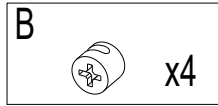

7

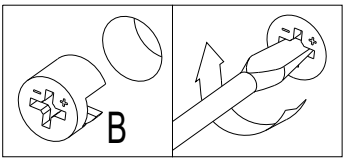
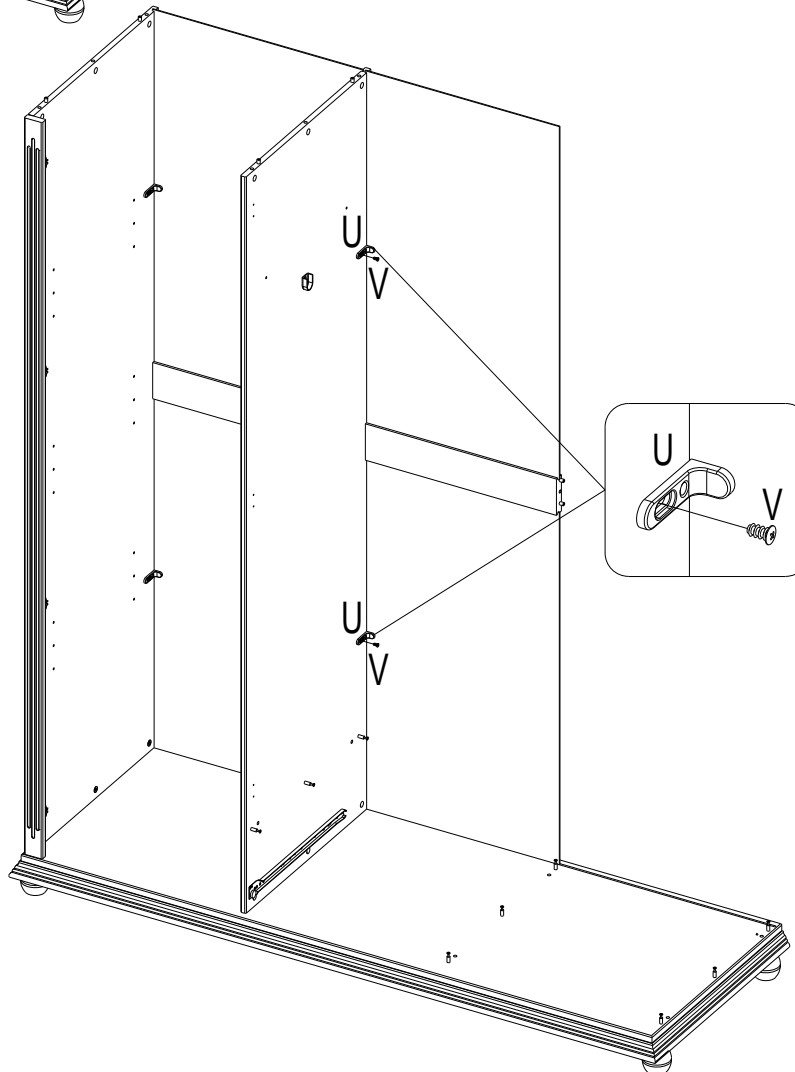
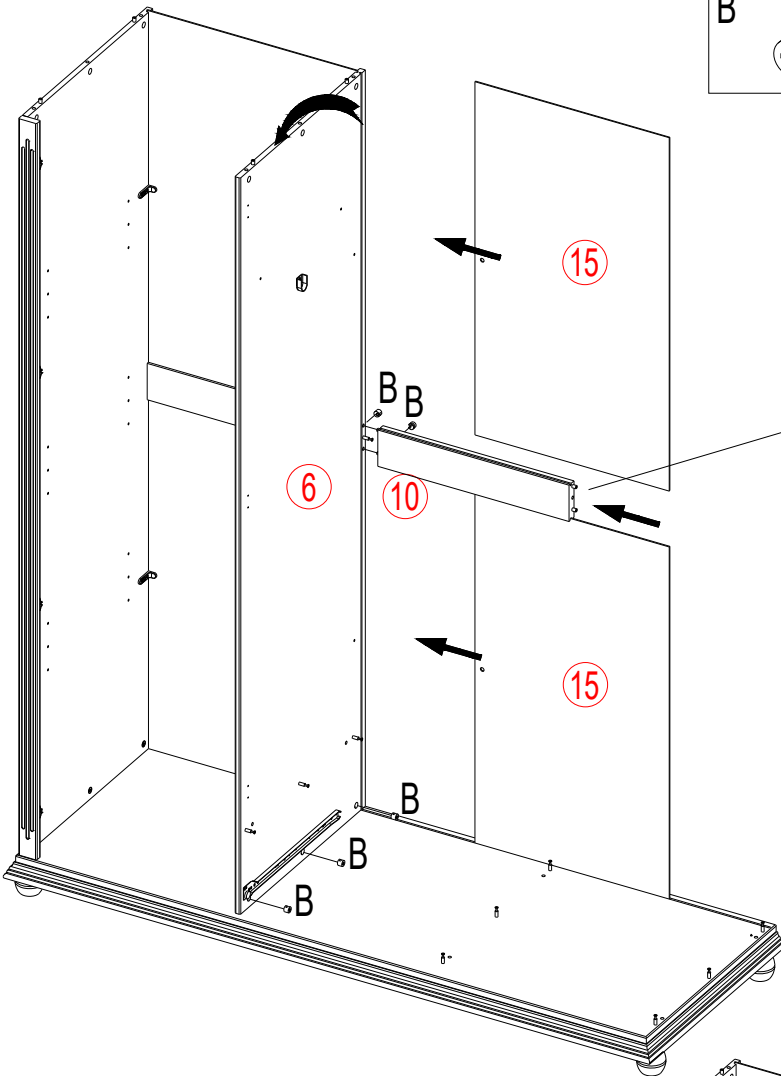
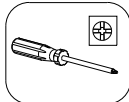
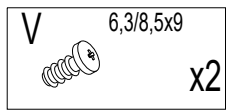
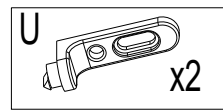
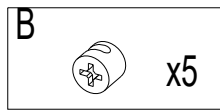

B  x11

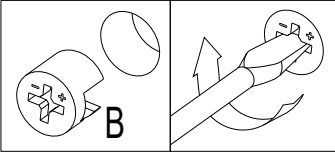
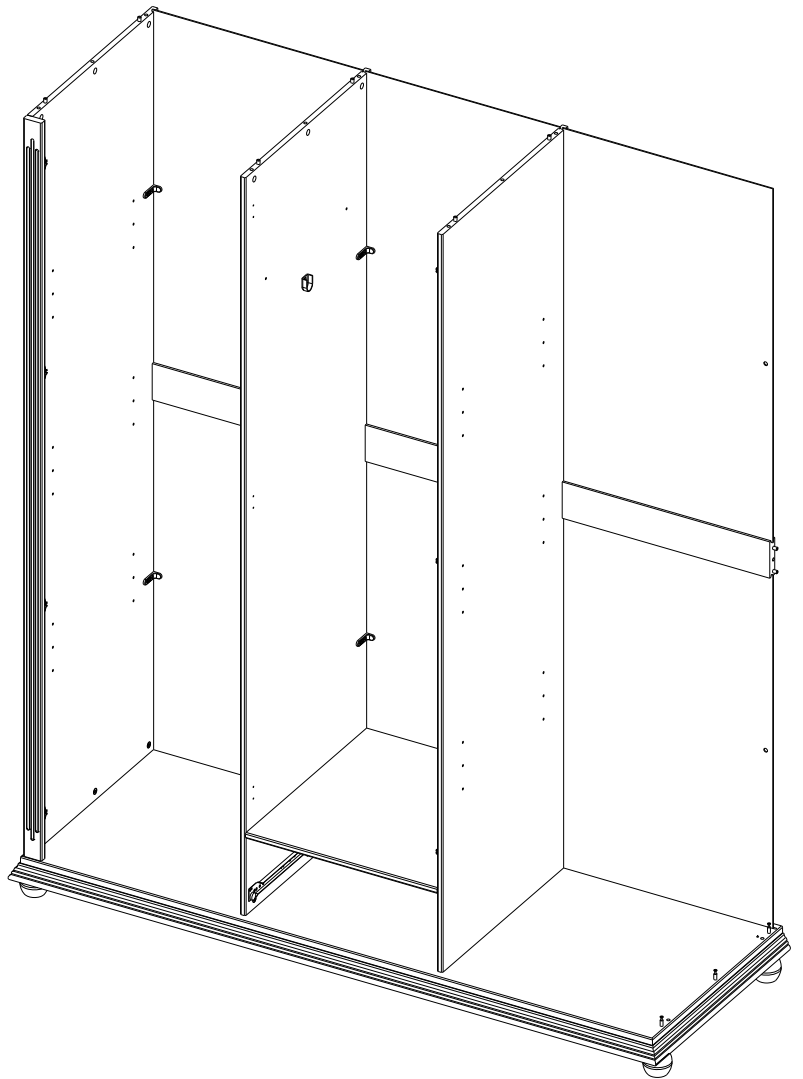
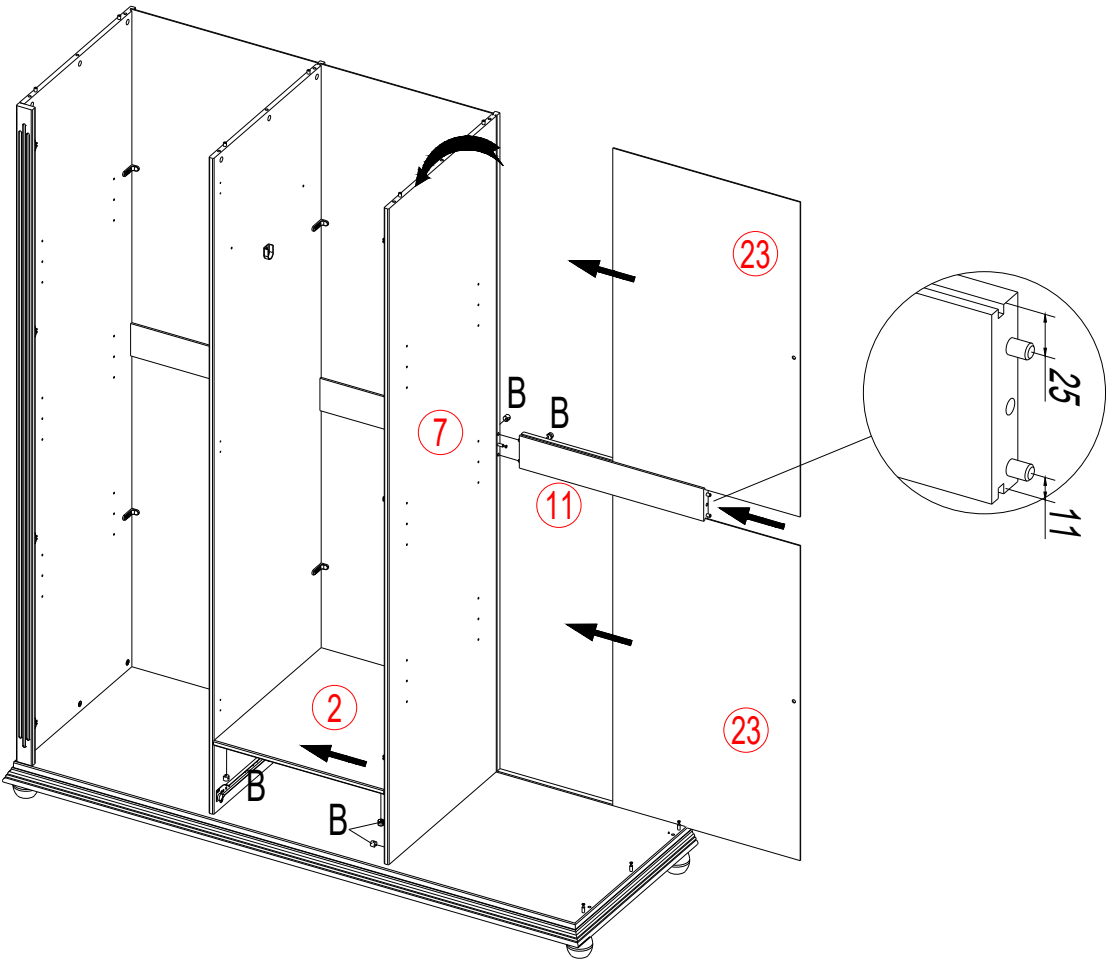
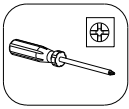

9

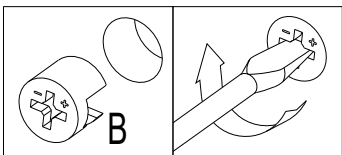
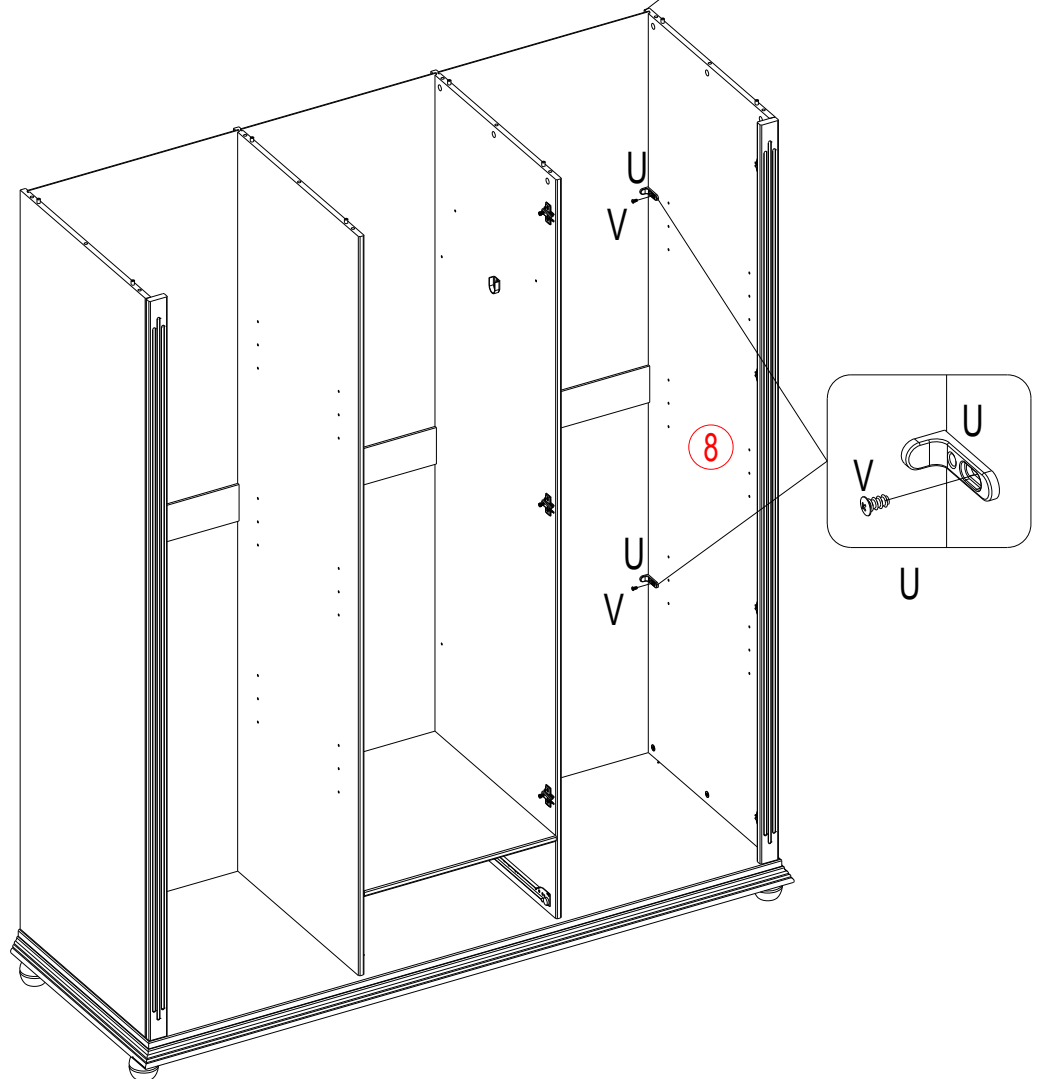
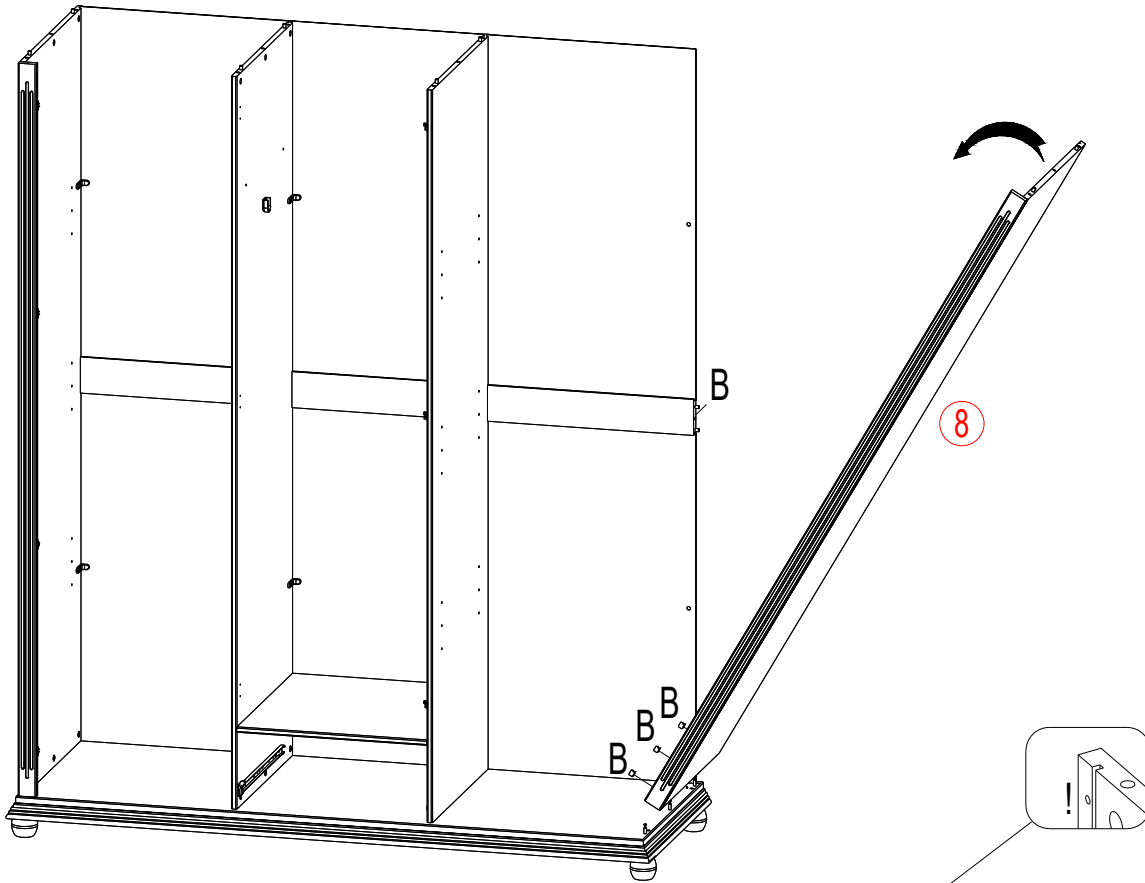
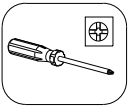
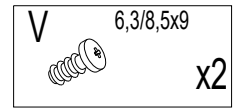
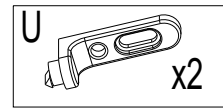
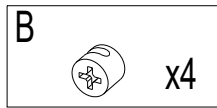

10

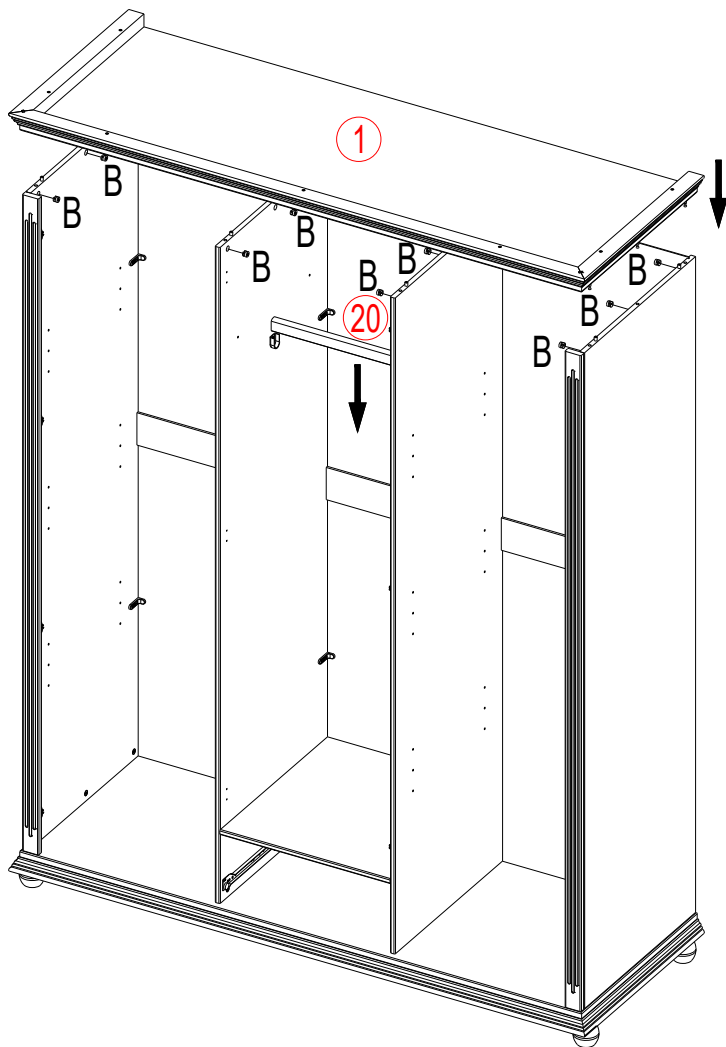

B  x12

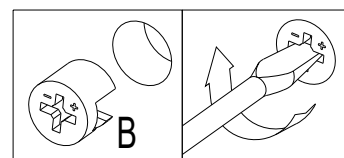
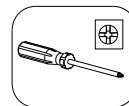

11

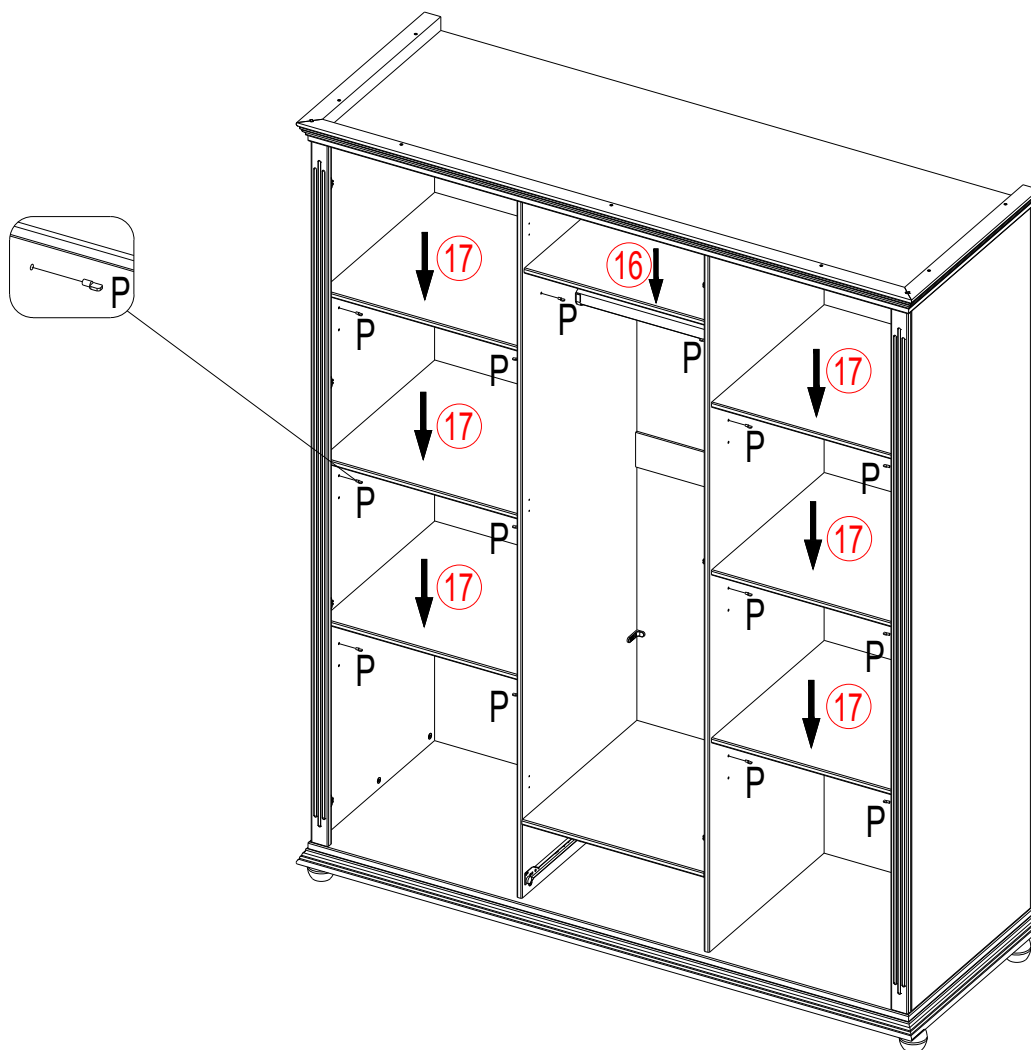

P  x28

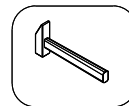

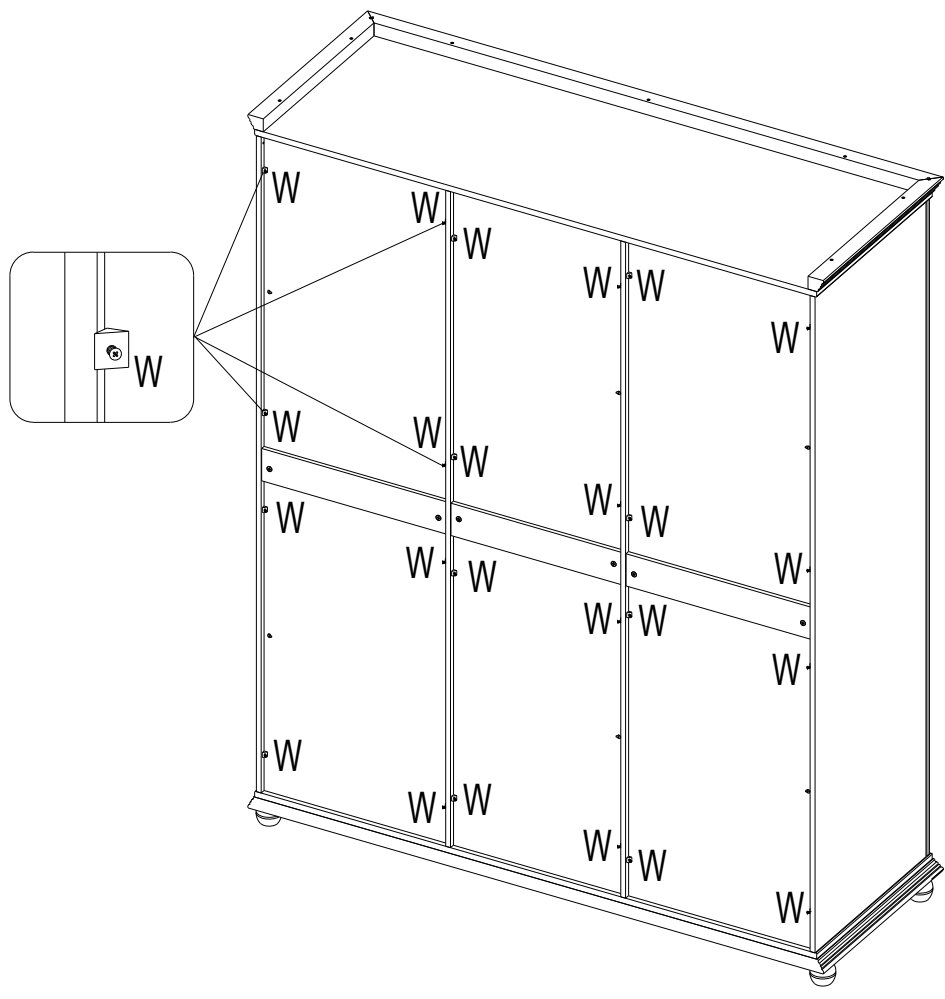

12

W  x24



13

Q 3.5x15  x2

X  Ø8x50 x2

Y 5x50  x2

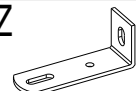
Z  x2

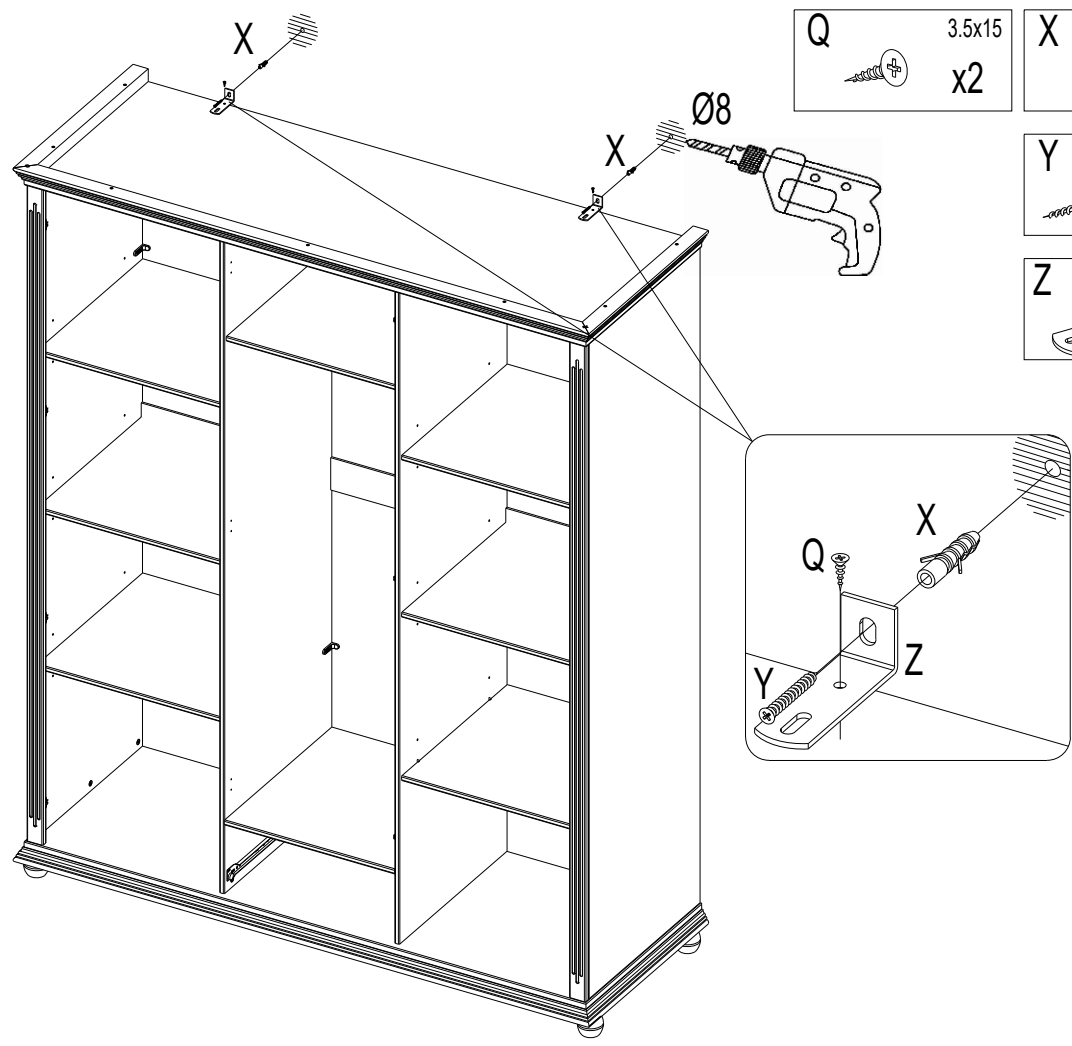
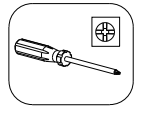

14

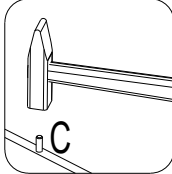
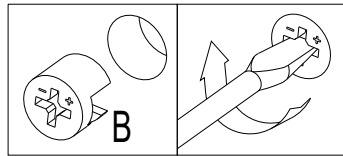
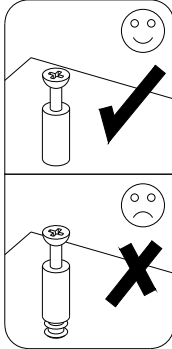
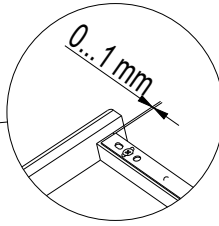
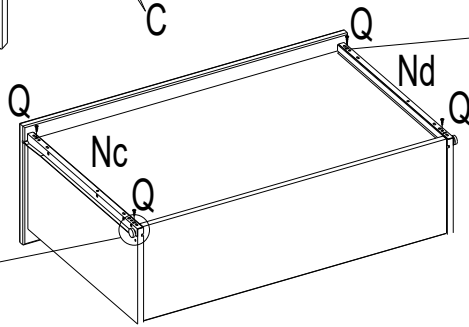
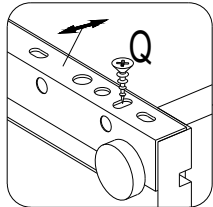
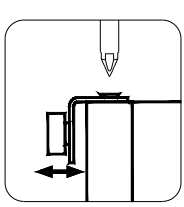
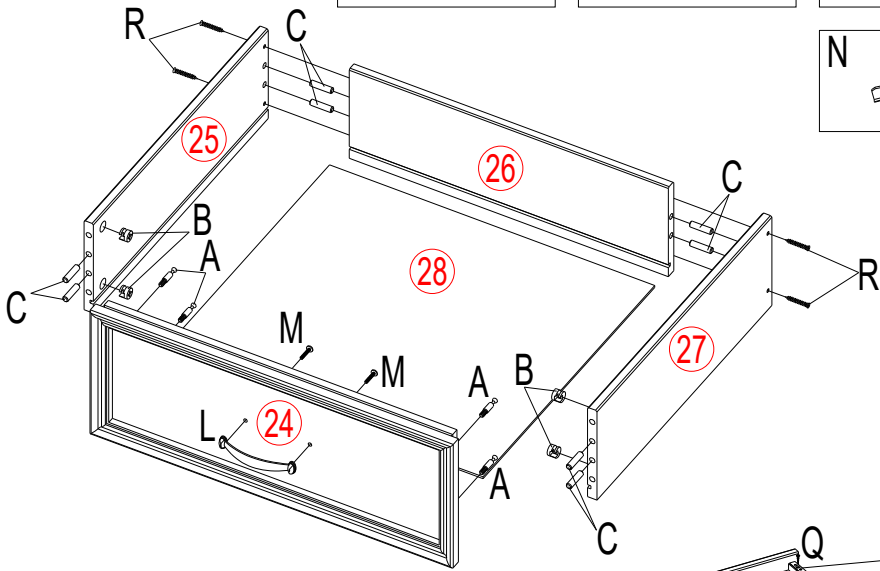
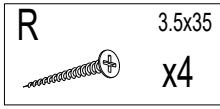
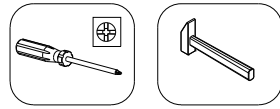
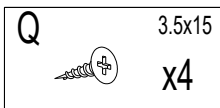
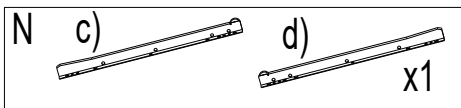
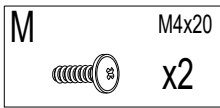
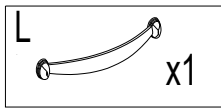
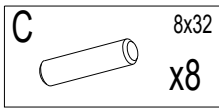
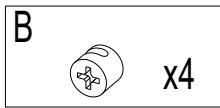
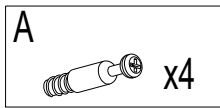

15

