

**120 min**

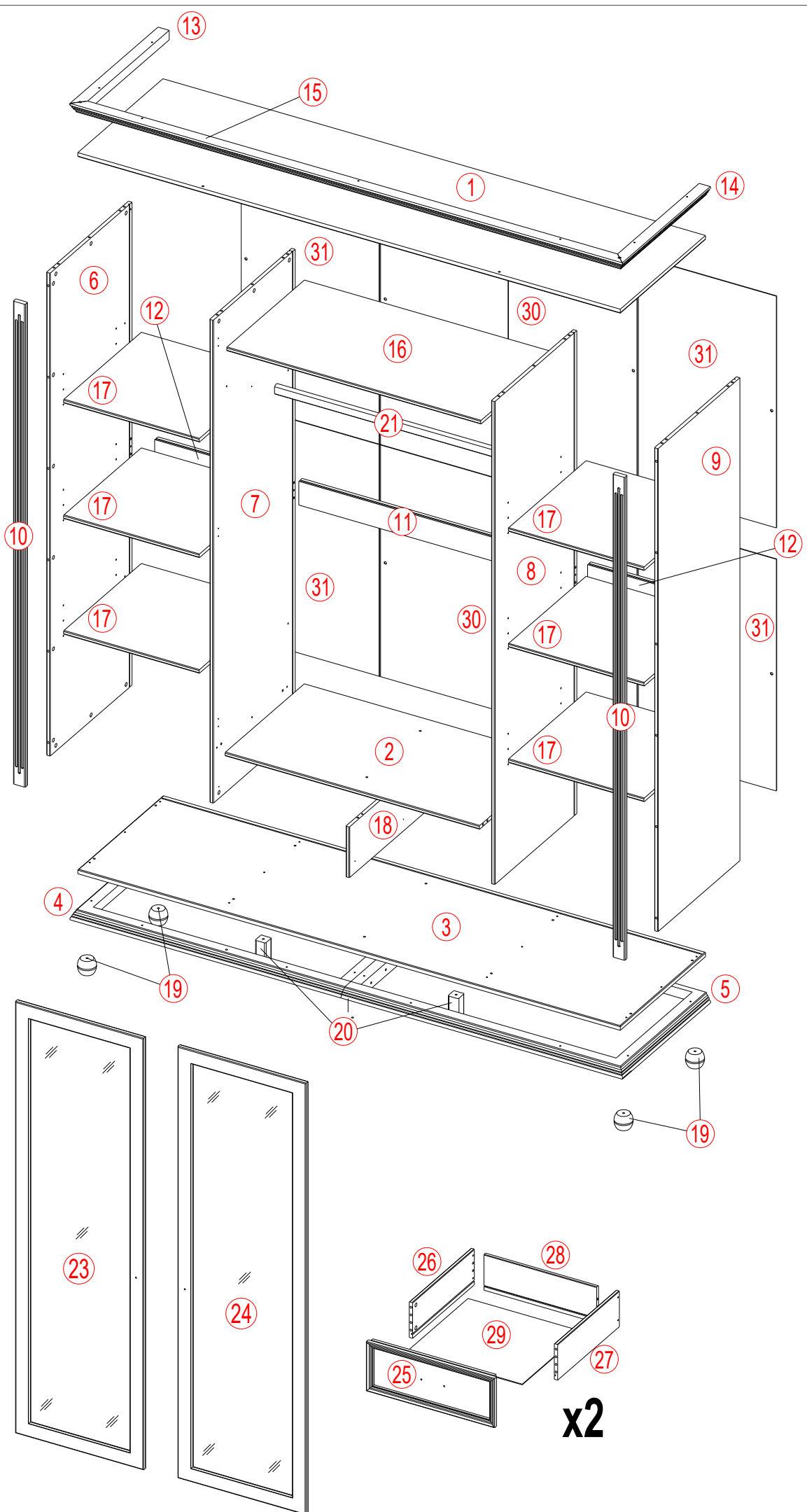

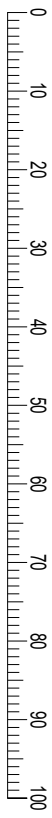
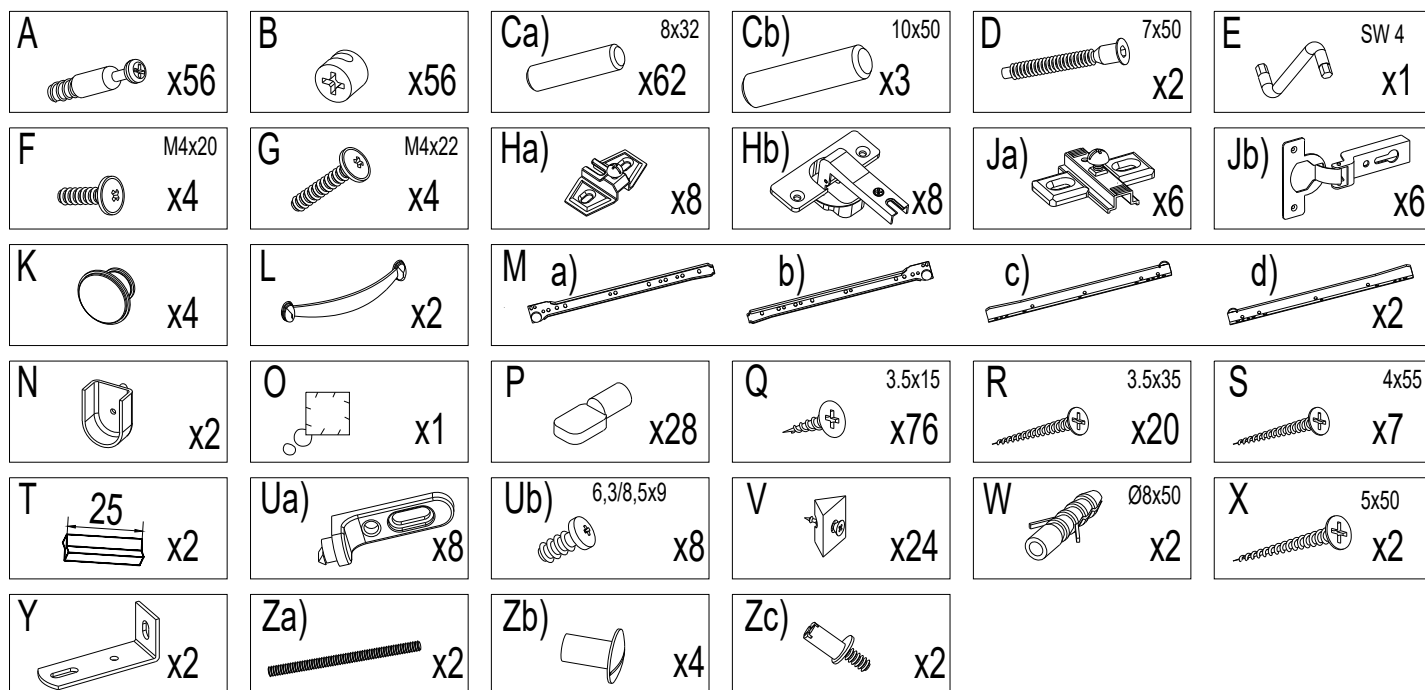

No	Size/MaB (mm)	Qty	Colli No	✓	No	Size/MaB (mm)	Qty	Colli No	✓
1	2281x620x18	1	1/4		17	570x566x15	6	2/5 3/5	
2	1069x577x15	1	1/5		18	577x213x15	1	2/5	
3	2281x620x18	1	4/5		19	60x70x70	4	1/5	
4	1162x642x40	1	1/5		20	100x54x54	2	1/5	
5	1162x642x40	1	1/5		21	1063x40x24	1	1/5	
6	2030x597x15	1	3/5		22	2024x539x18	2	5/5	
7	2030x597x15	1	2/5		23	1814x539x18	1	5/5	
8	2030x597x15	1	2/5		24	1814x539x18	1	5/5	
9	2030x597x15	1	3/5		25	539x207x33	2	1/5	
10	2030x50x18	2	5/5		26	450x150x14	2	1/5	
11	1069x100x24	1	1/5		27	450x150x14	2	1/5	
12	571x100x24	2	1/5		28	474x150x14	2	1/5	
13	642x48x40	1	1/5		29	483x442x3	2	1/5	
14	642x48x40	1	1/5		30	974x1078x3	2	4/5	
15	2324x48x40	1	4/5		31	974x580x3	4	2/5 3/5	
16	1068x566x15	1	1/5						

1

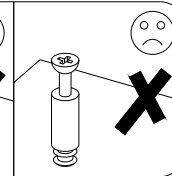
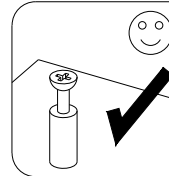
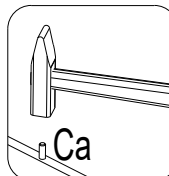
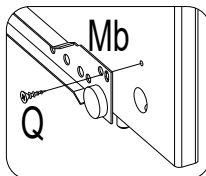
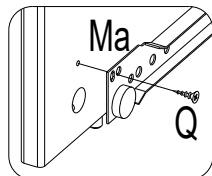
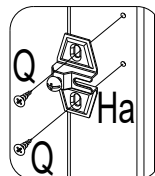
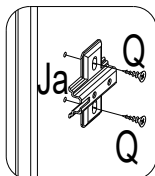
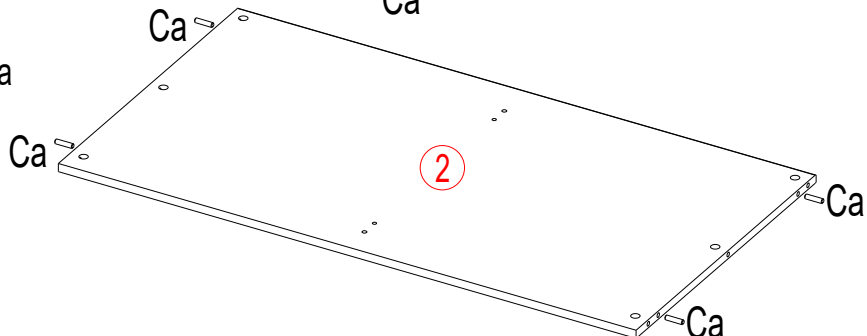
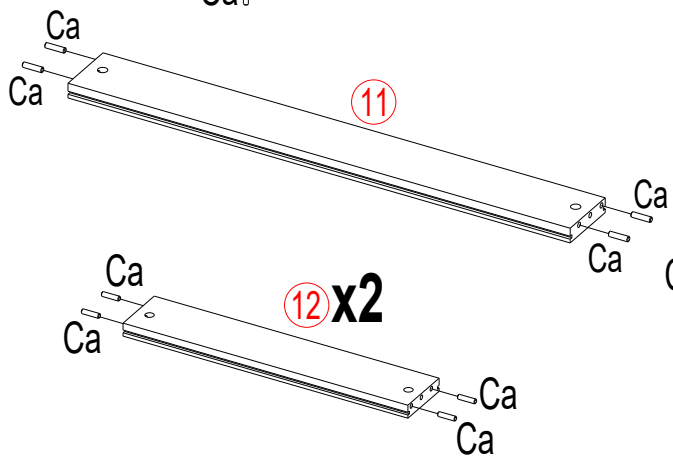
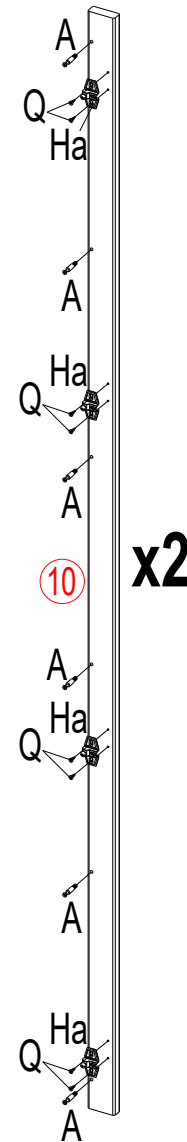
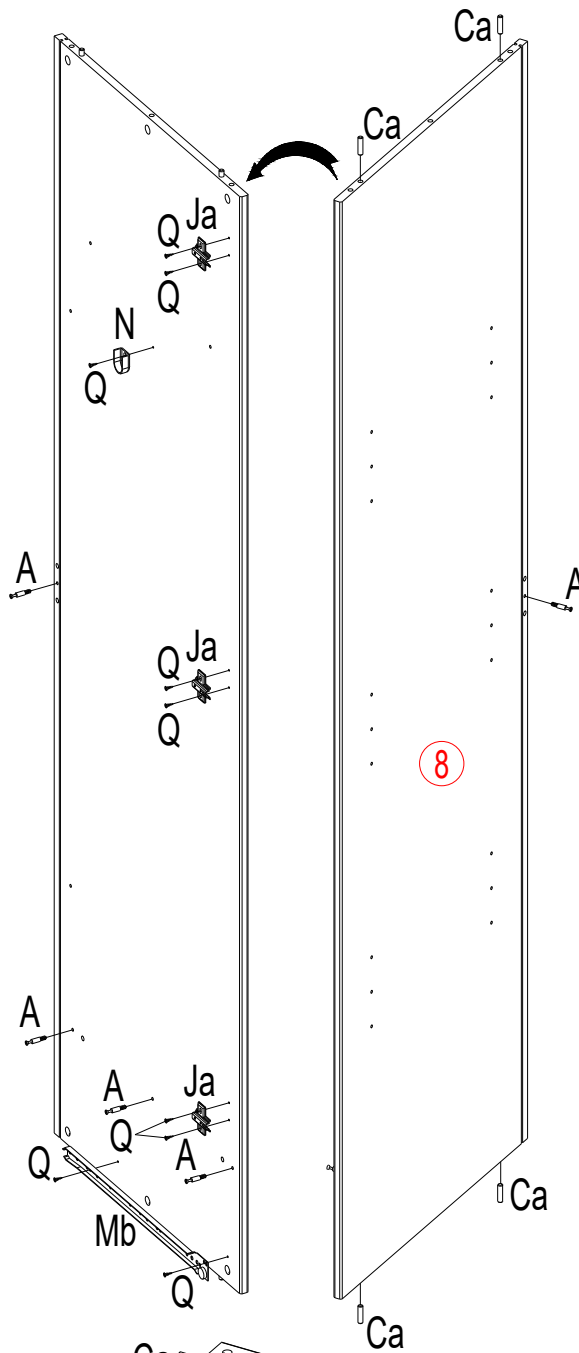
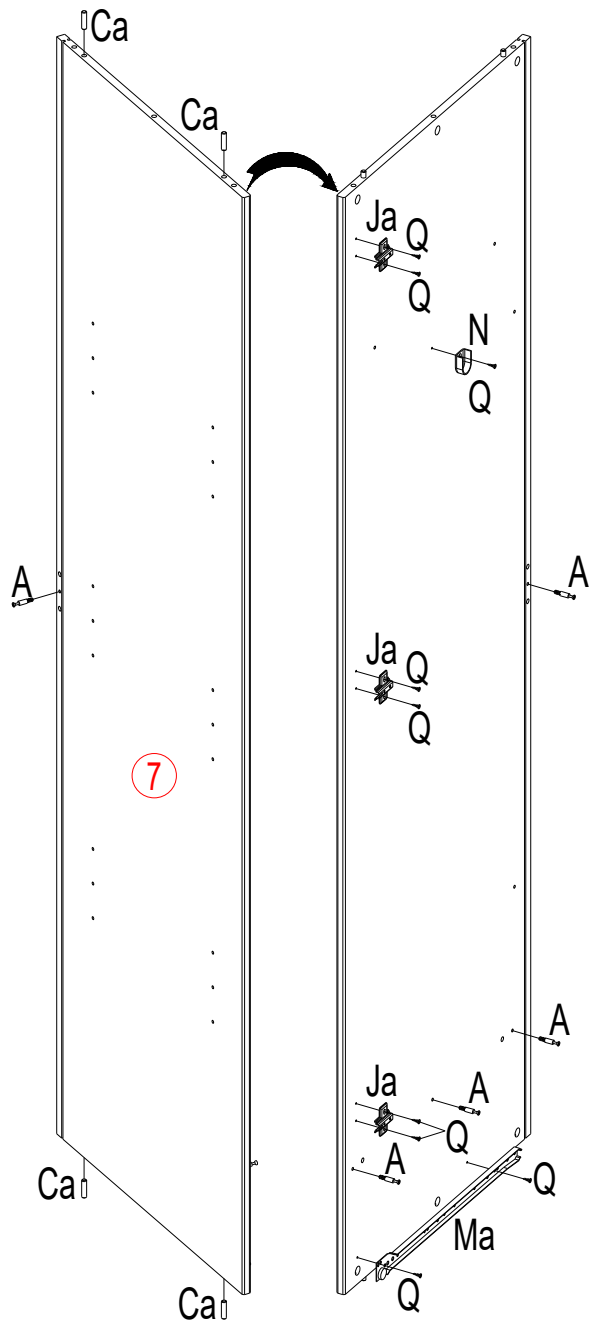
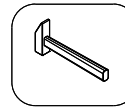
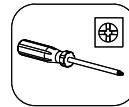
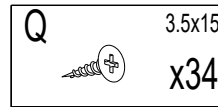
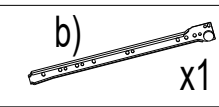
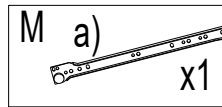
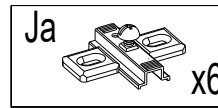
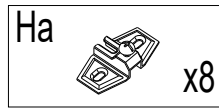
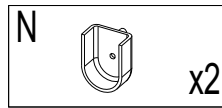
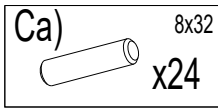
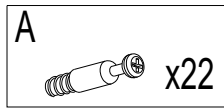

2

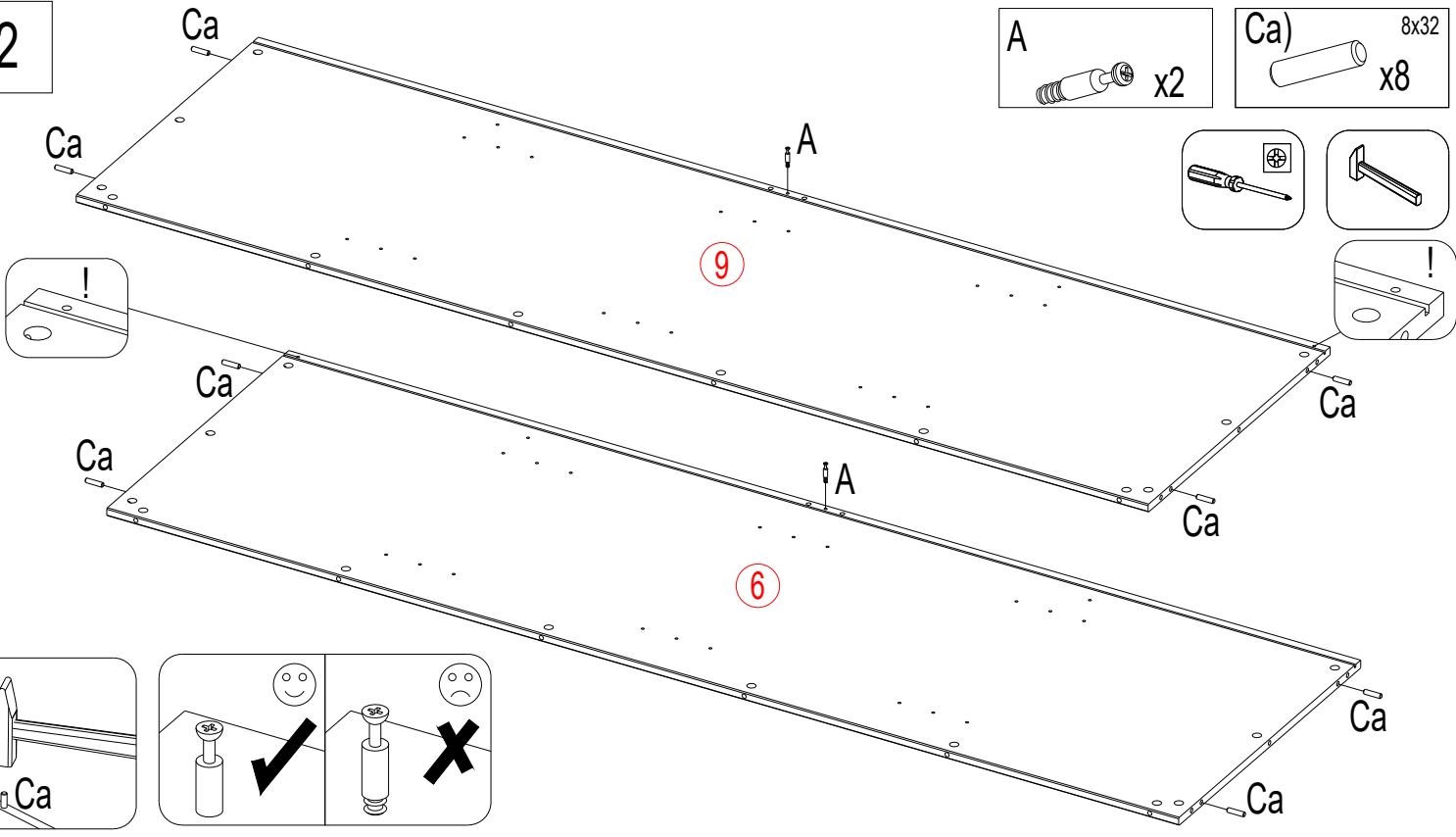
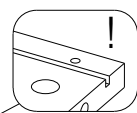
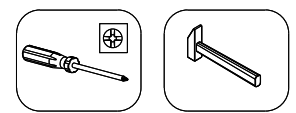
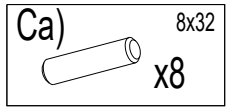
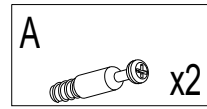

3

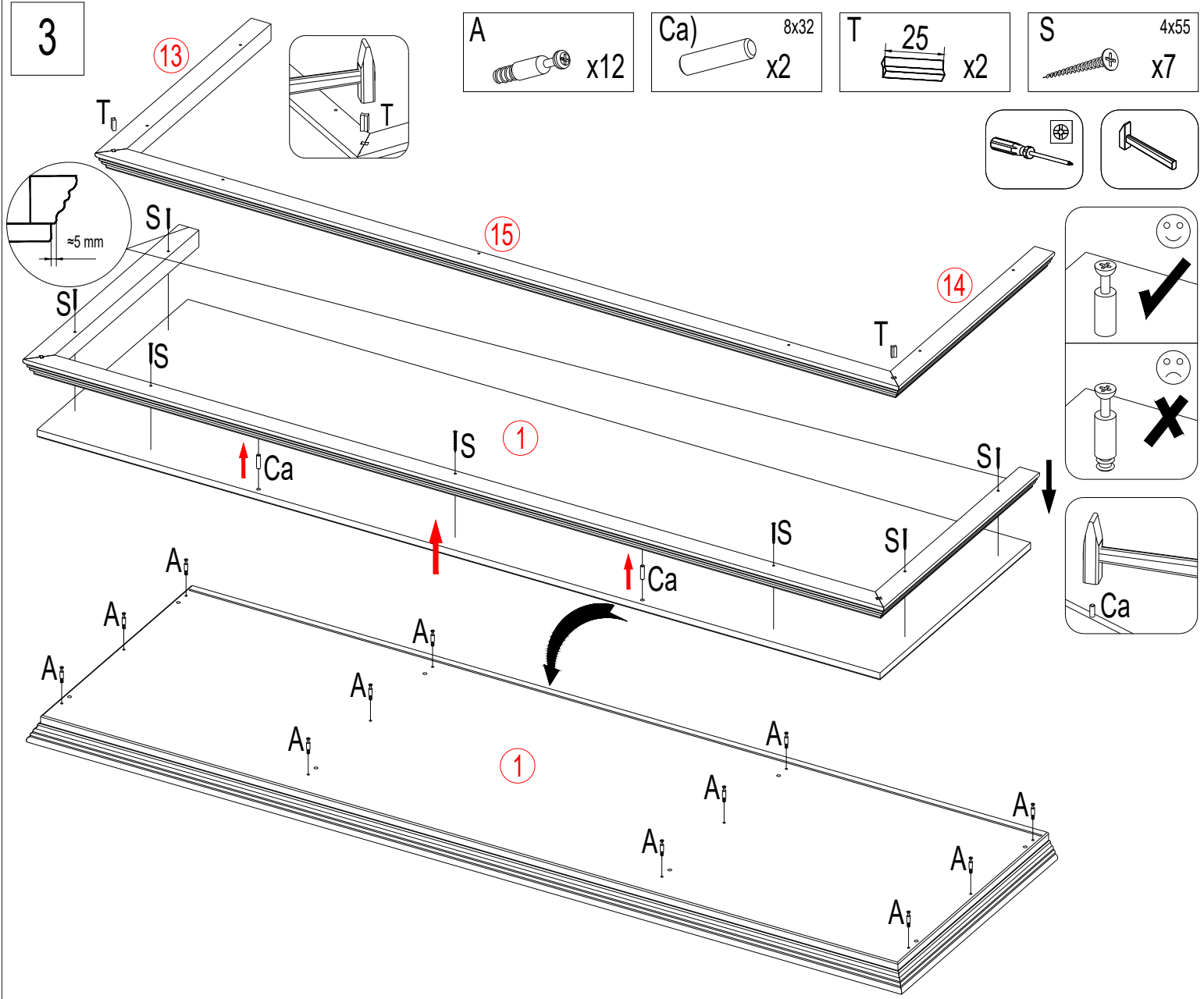
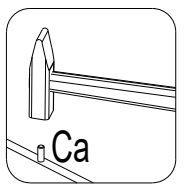
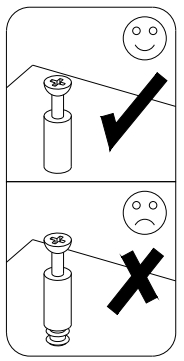
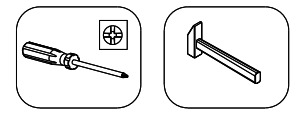
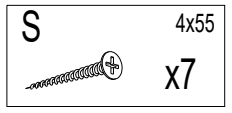
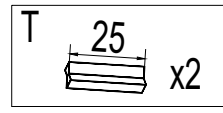
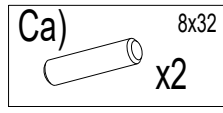
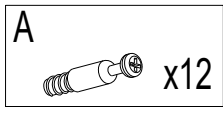

- |          |  |              |                    |                     |                     |
|----------|--|--------------|--------------------|---------------------|---------------------|
| <b>4</b> |  | <b>A</b> x12 | <b>Ca)</b> 8x32 x8 | <b>Cb)</b> 10x50 x3 | <b>R</b> 3.5x35 x12 |
|          |  |              | <b>O</b> x1        | <b>Za)</b> x2       | <b>Zb)</b> x4       |

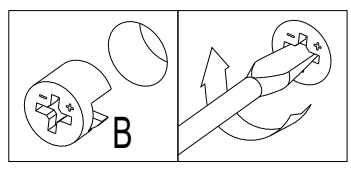
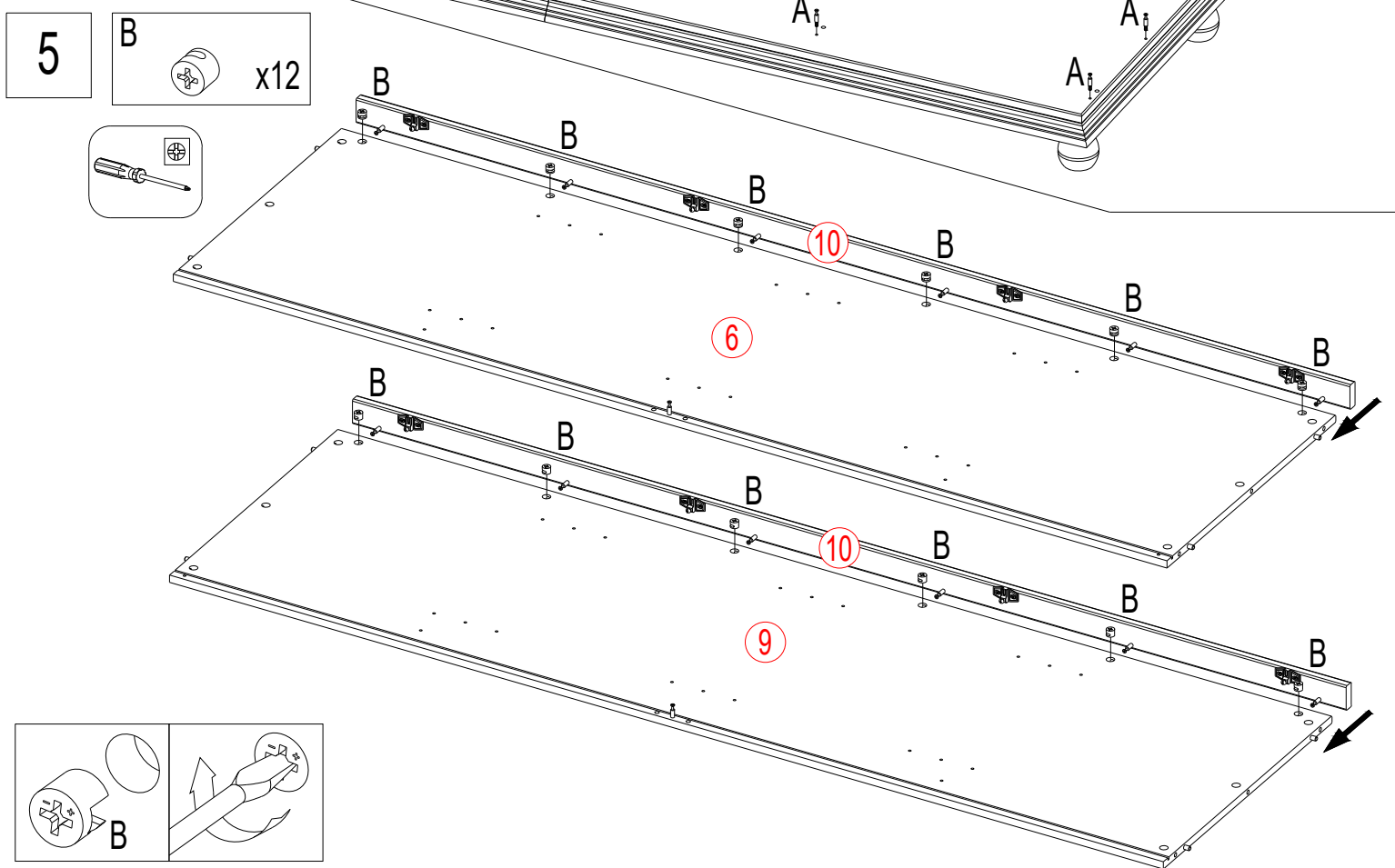
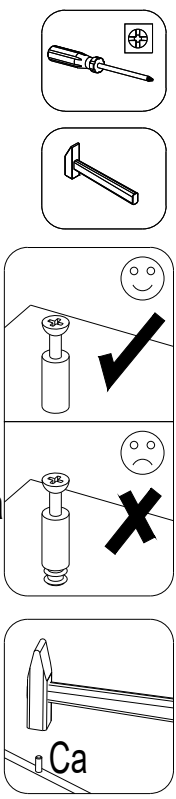
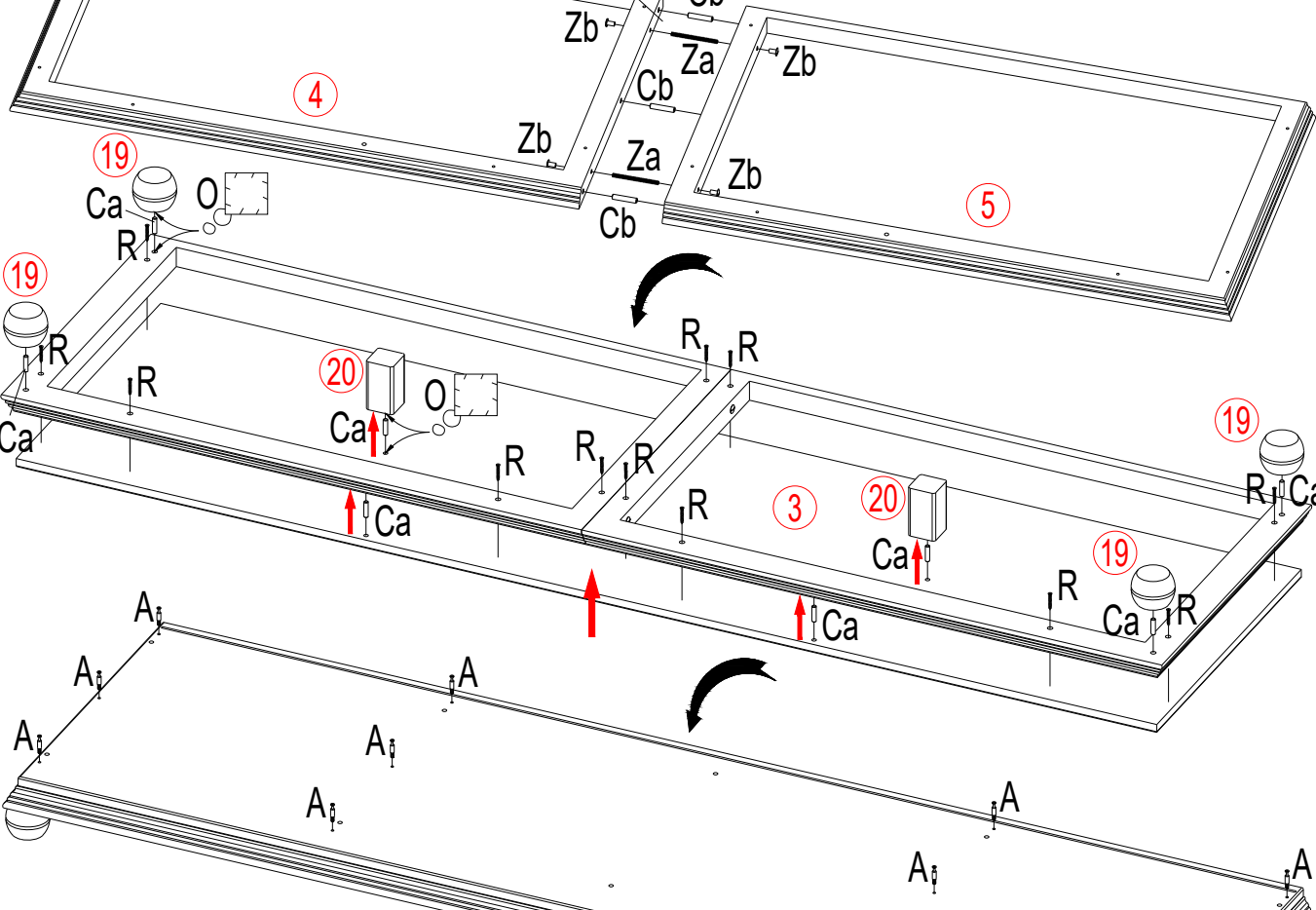

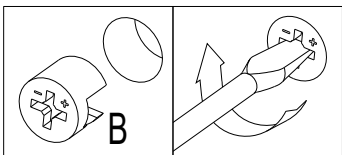
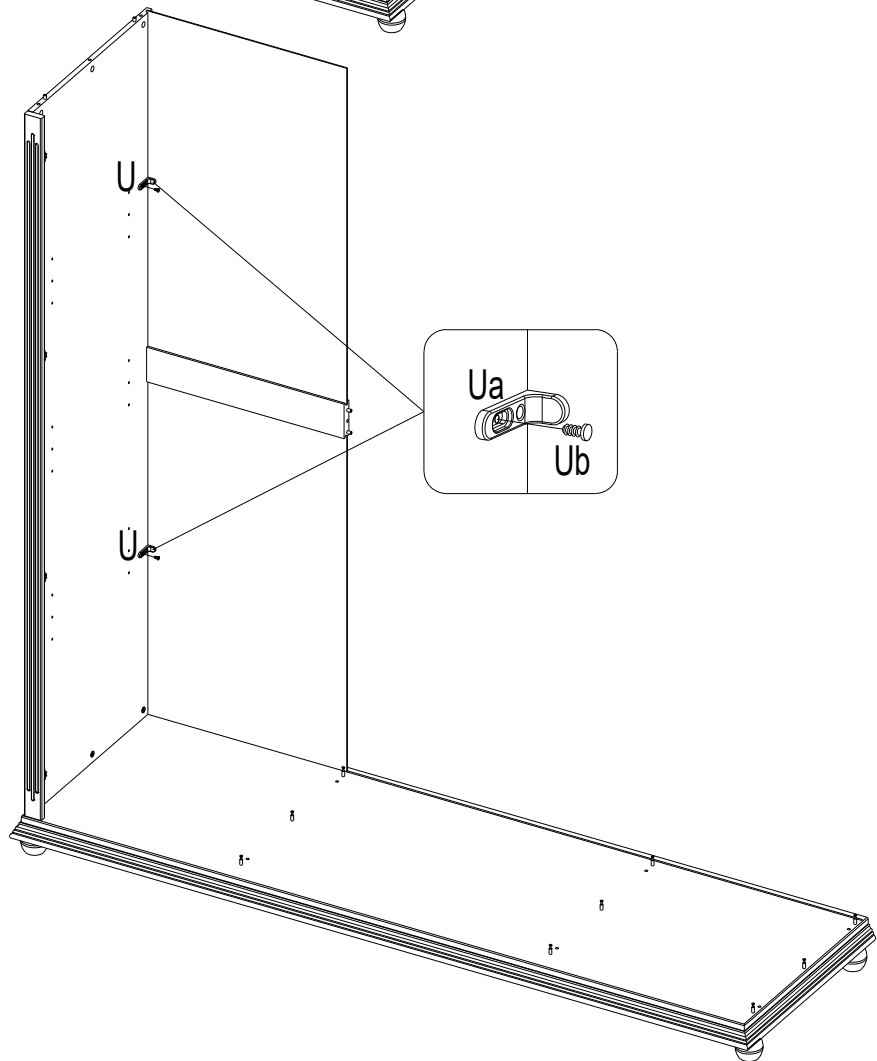
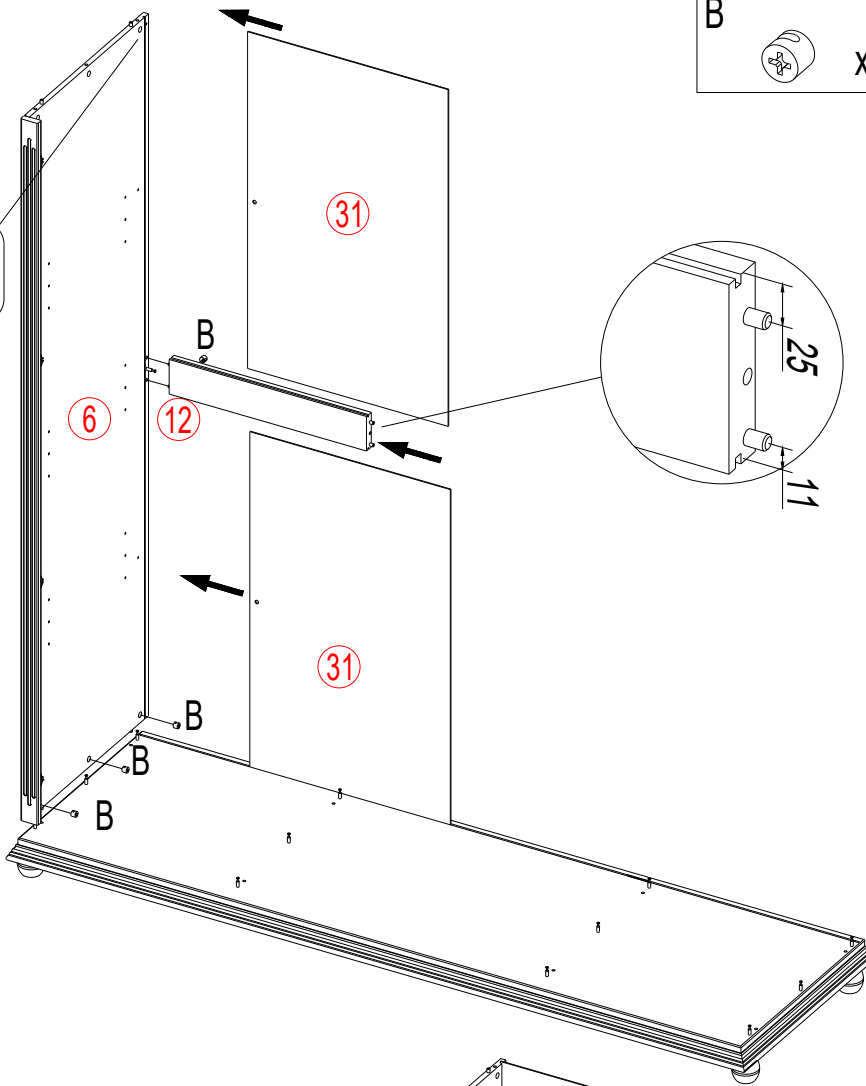
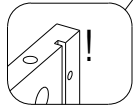
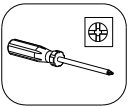
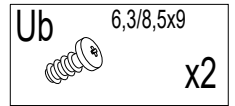
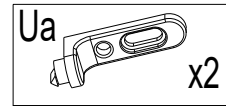
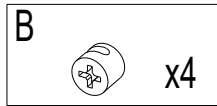

6



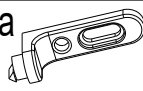

7

**B**  x8

**Ua**  x2

**Ub** 6,3/8,5x9  x2

**D** 7x50  x2

**E** SW 4  x1

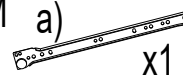

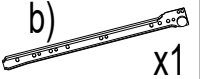
**M a)**  x1

**b)**  x1

**Ca)** 8x32  x4

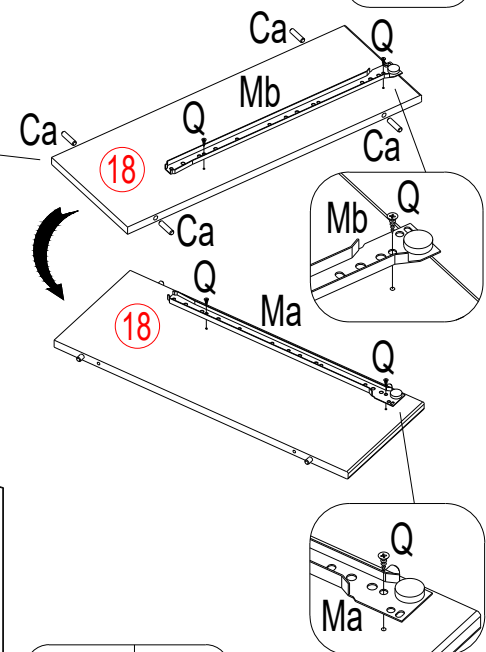
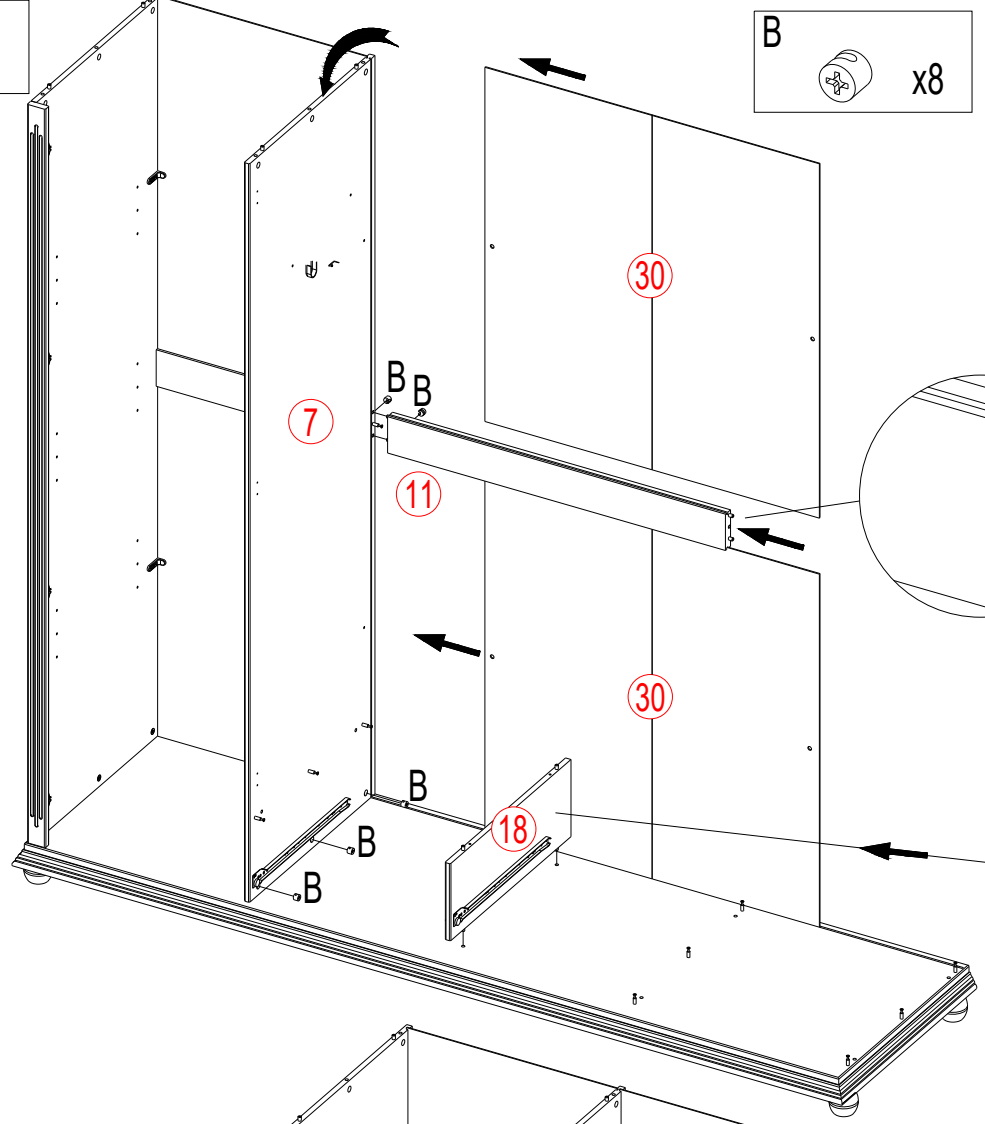
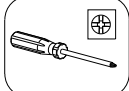
**Q** 3.5x15  x4



**Ua**  **Ub** 

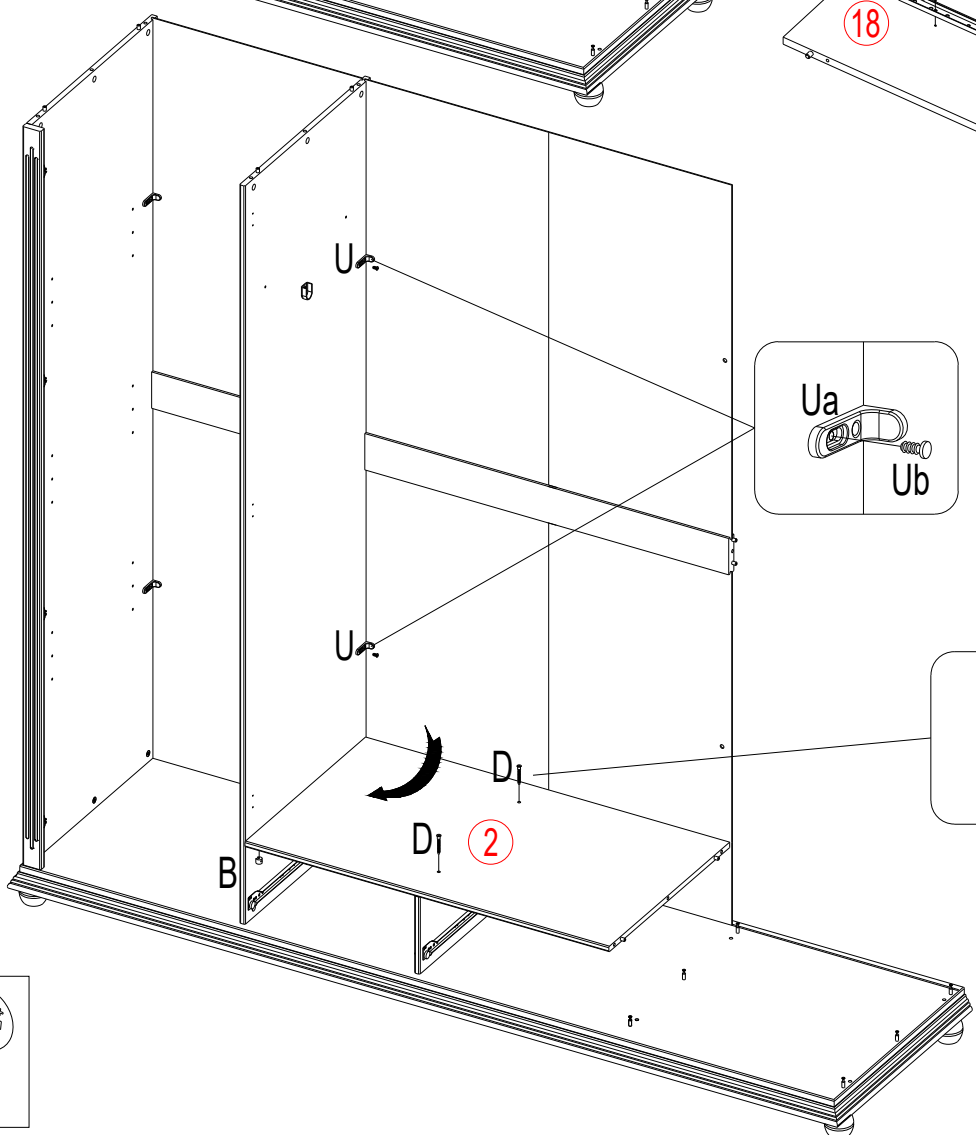
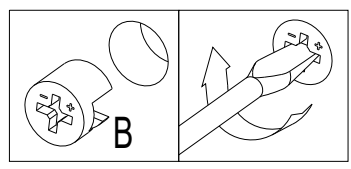
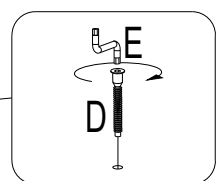



8

B x8

Ua x2

Ub 6,3/8,5x9 x2

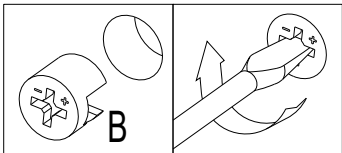
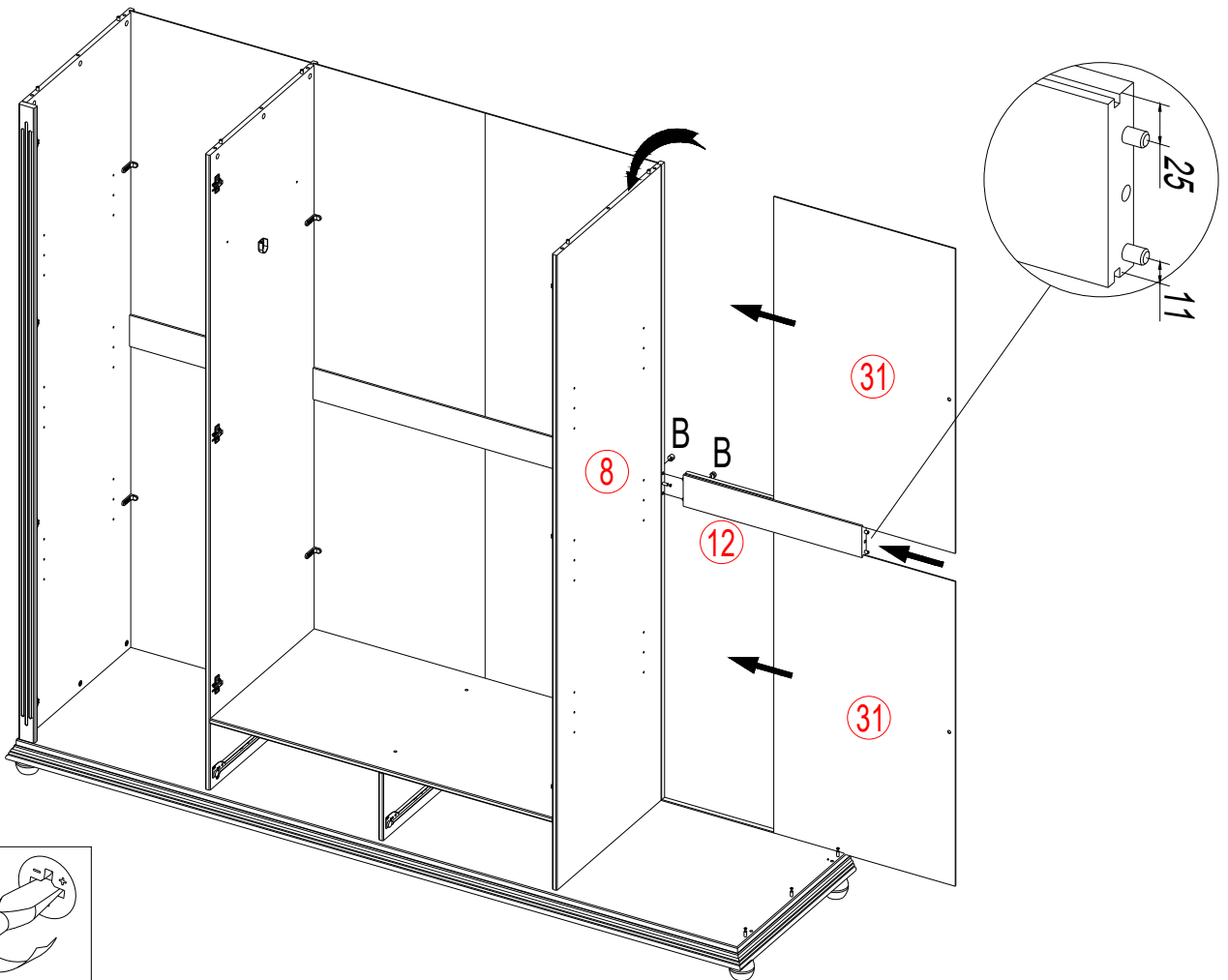
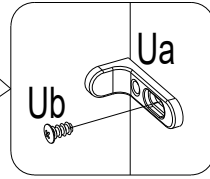
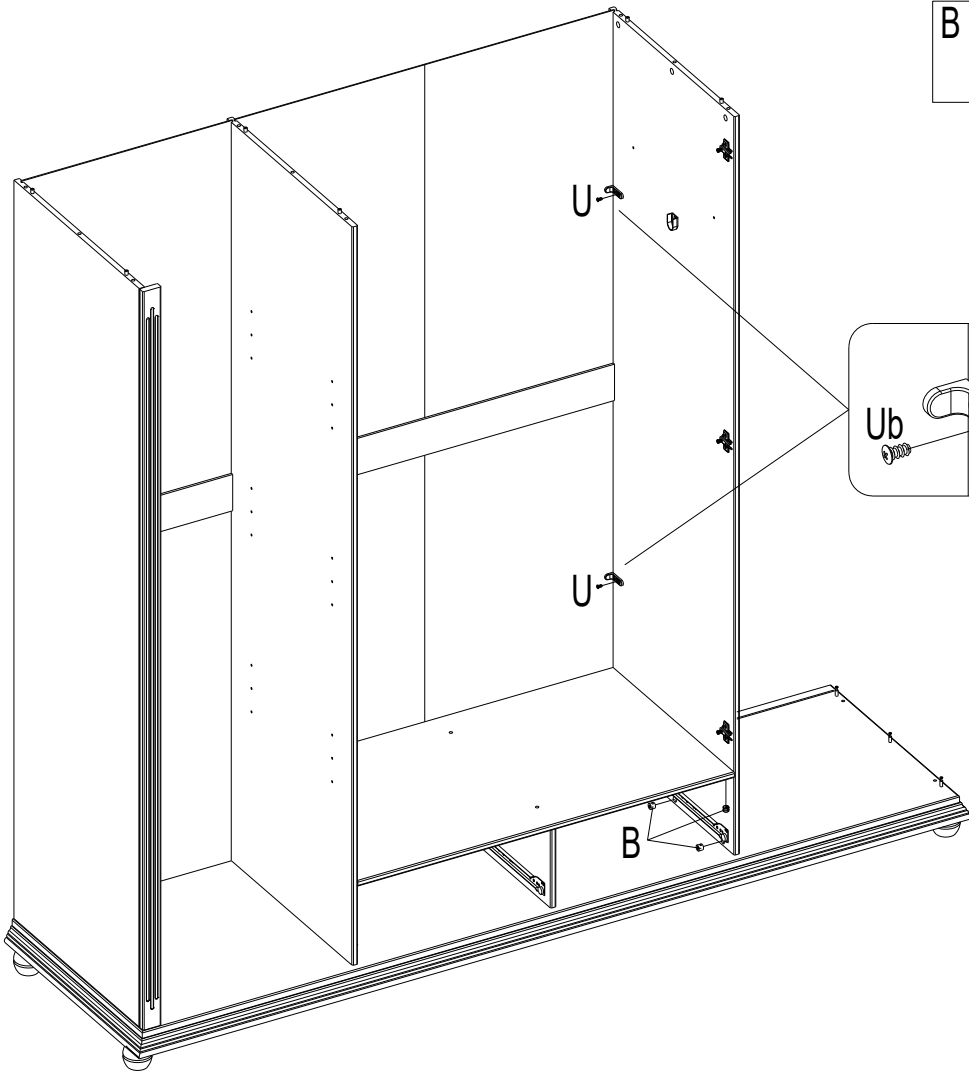
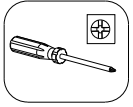

9

B x4

Ua x2

Ub 6,3/8,5x9 x2

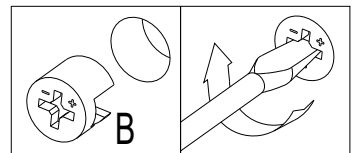
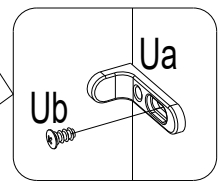
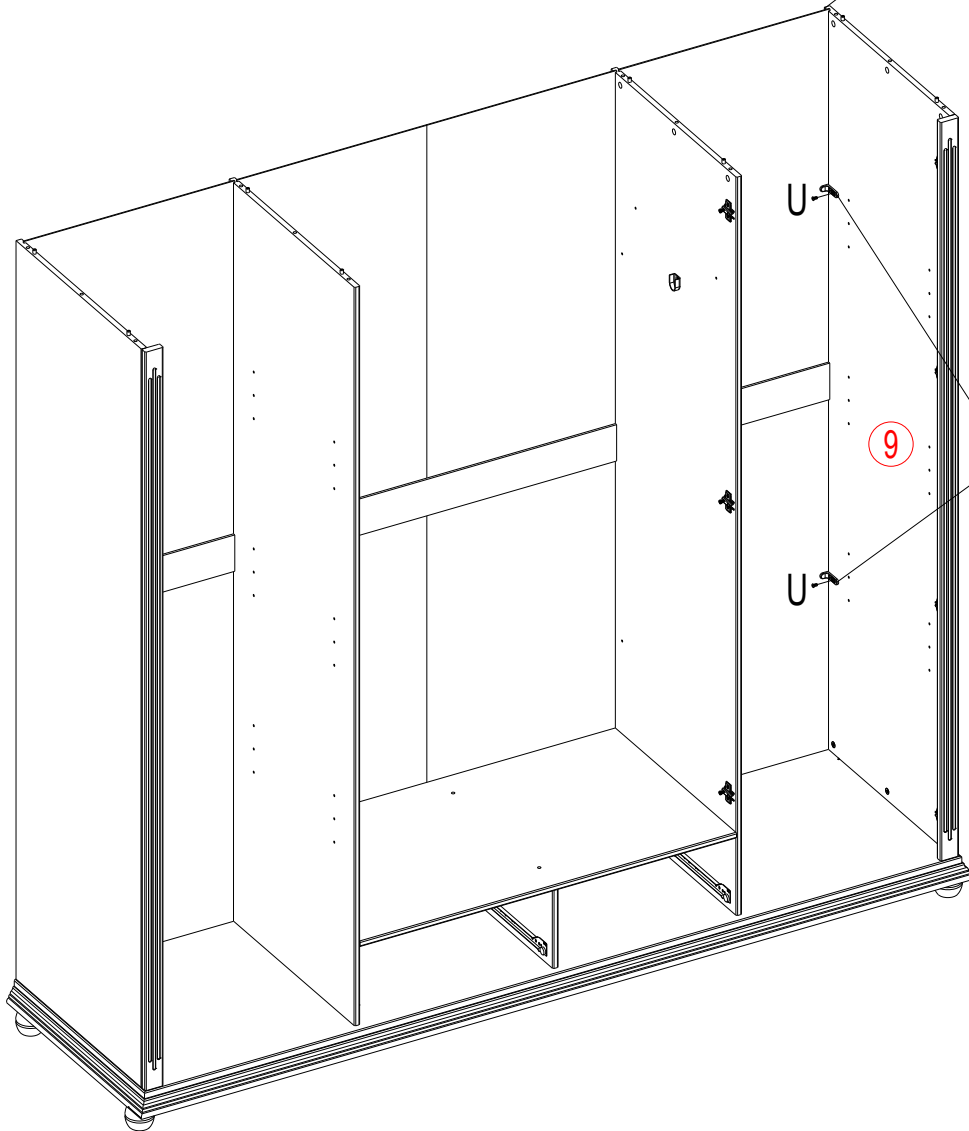
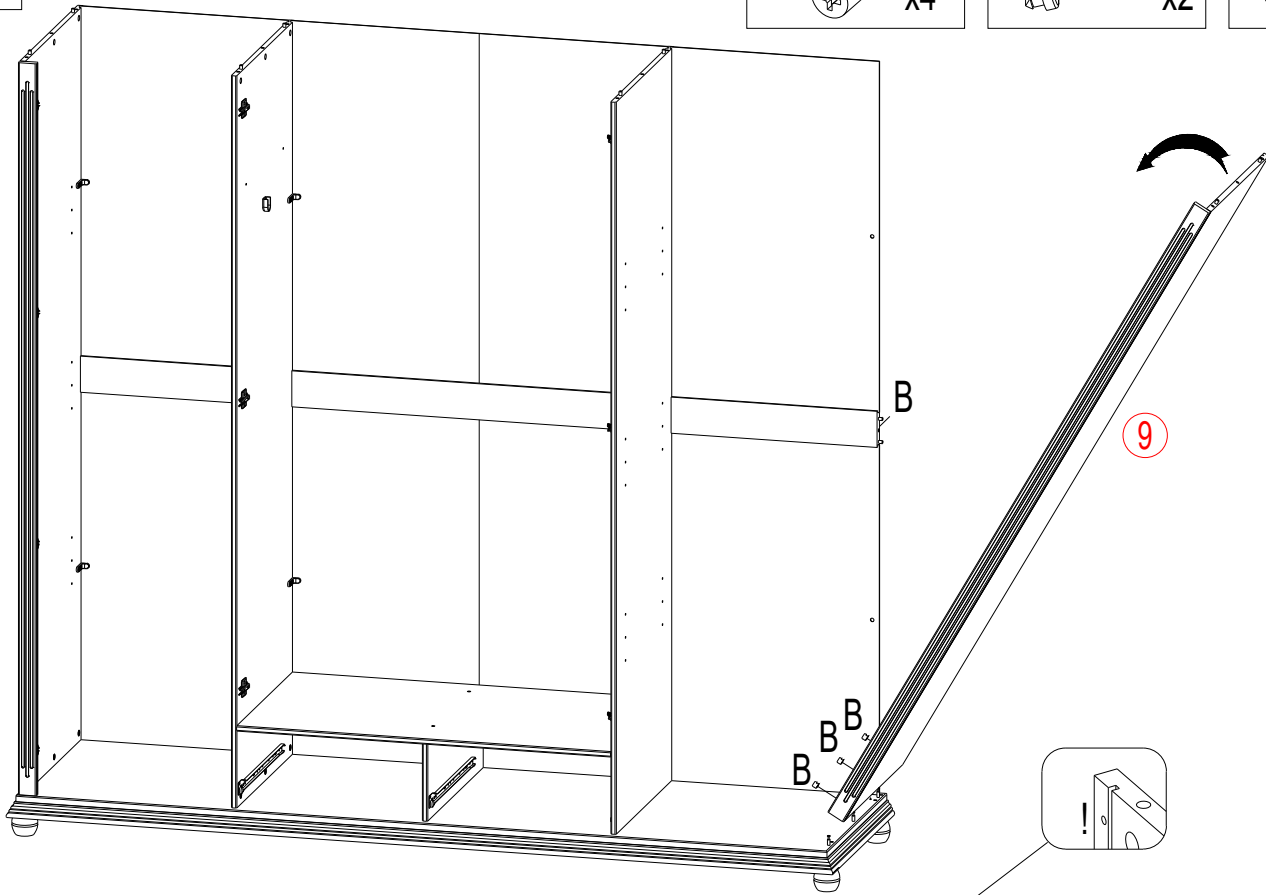
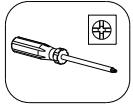

10

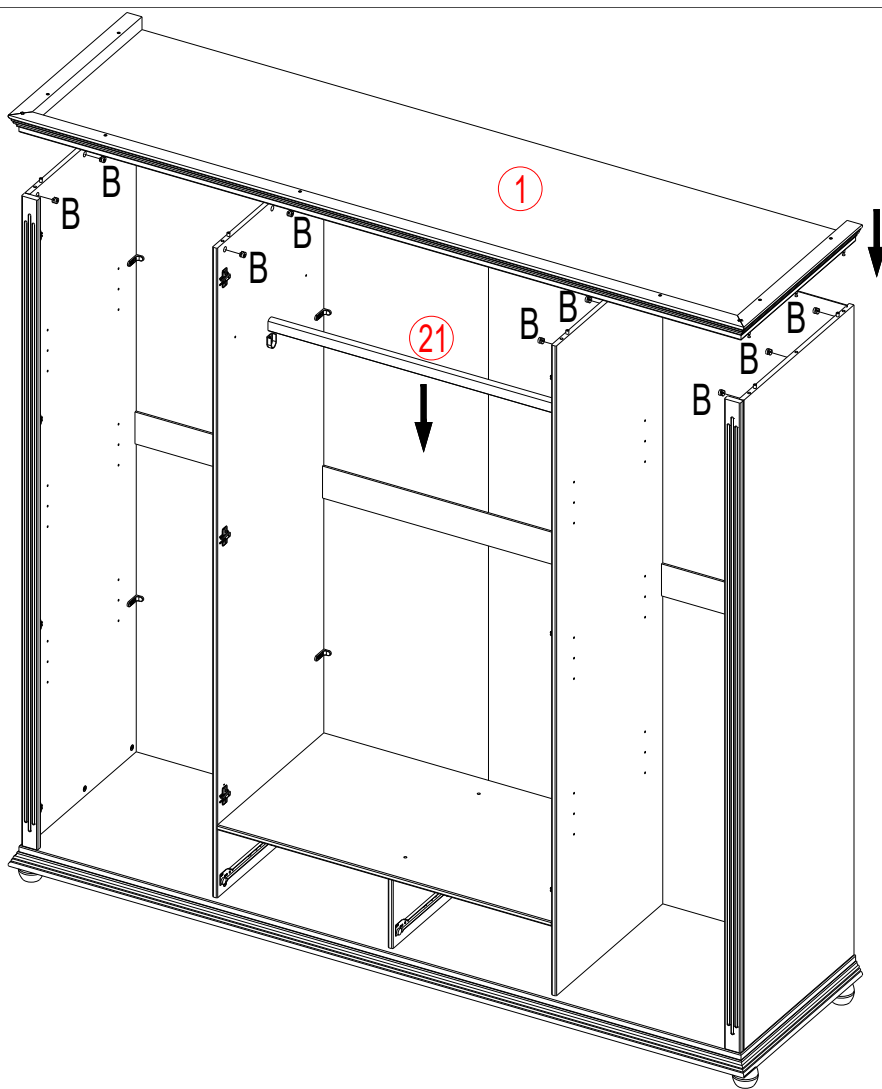

B x12

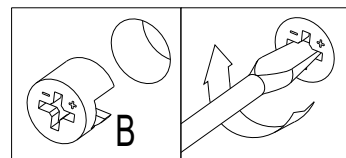
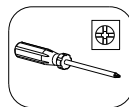

11

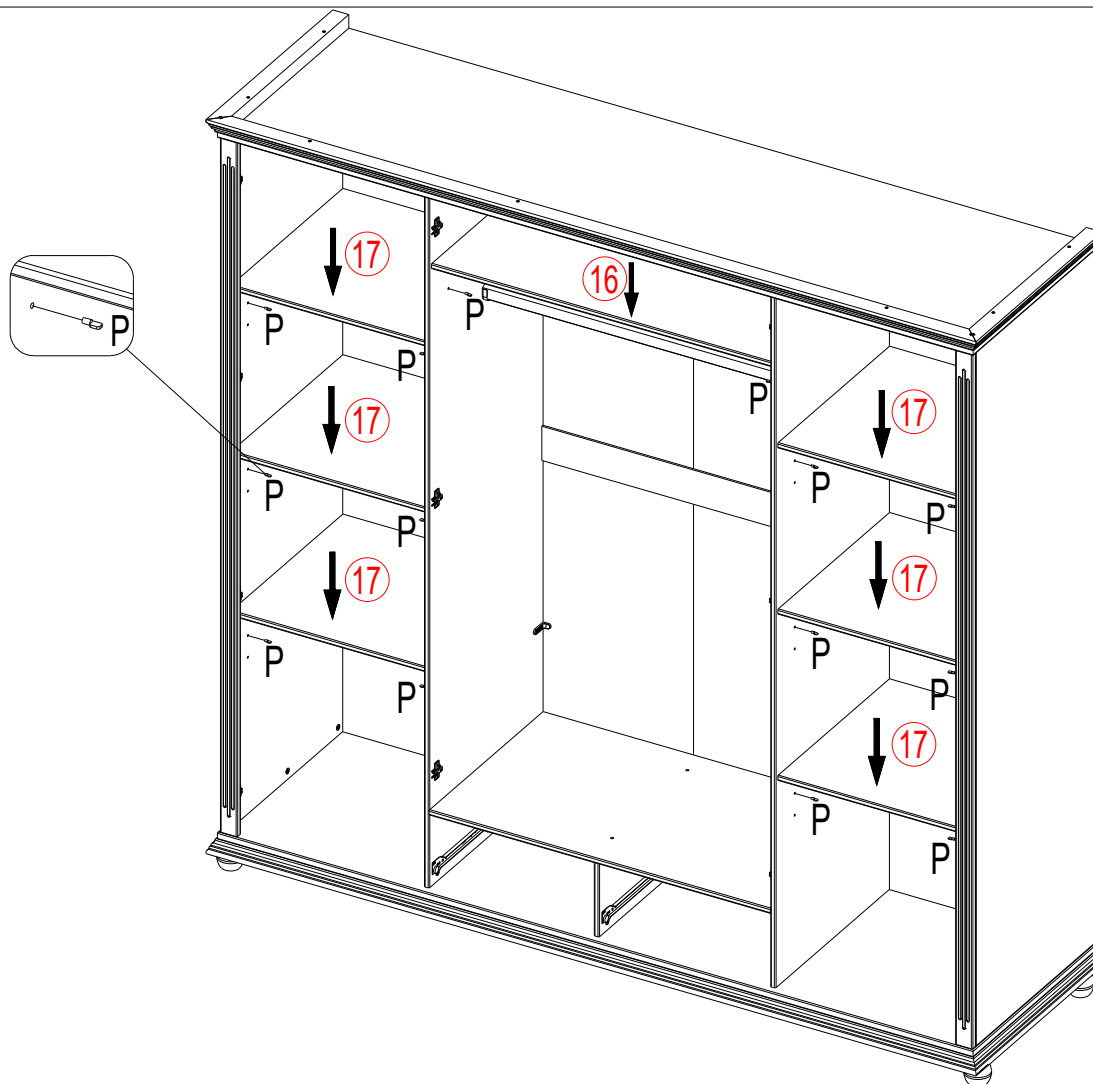

P x28

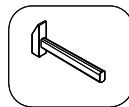

12

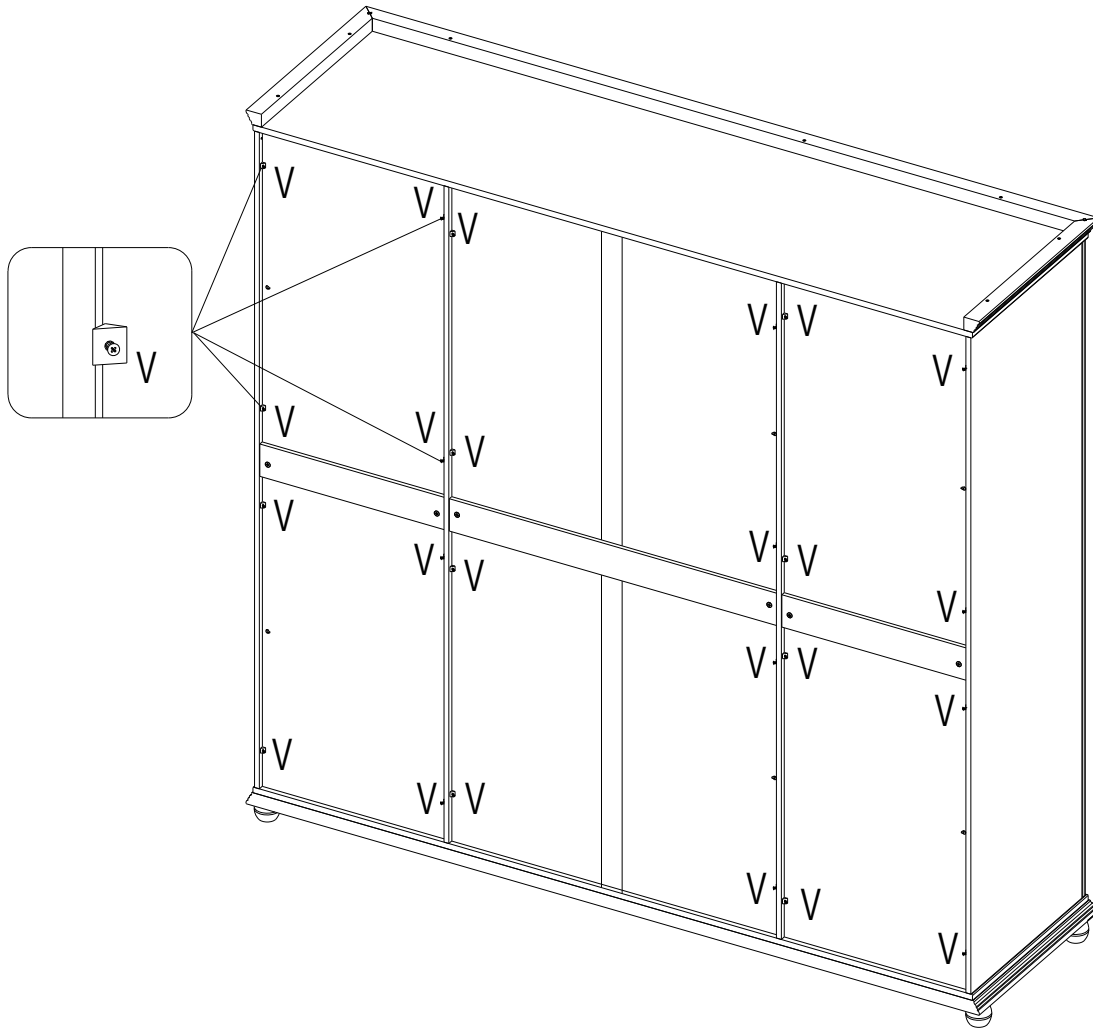

V x24

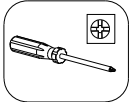

13

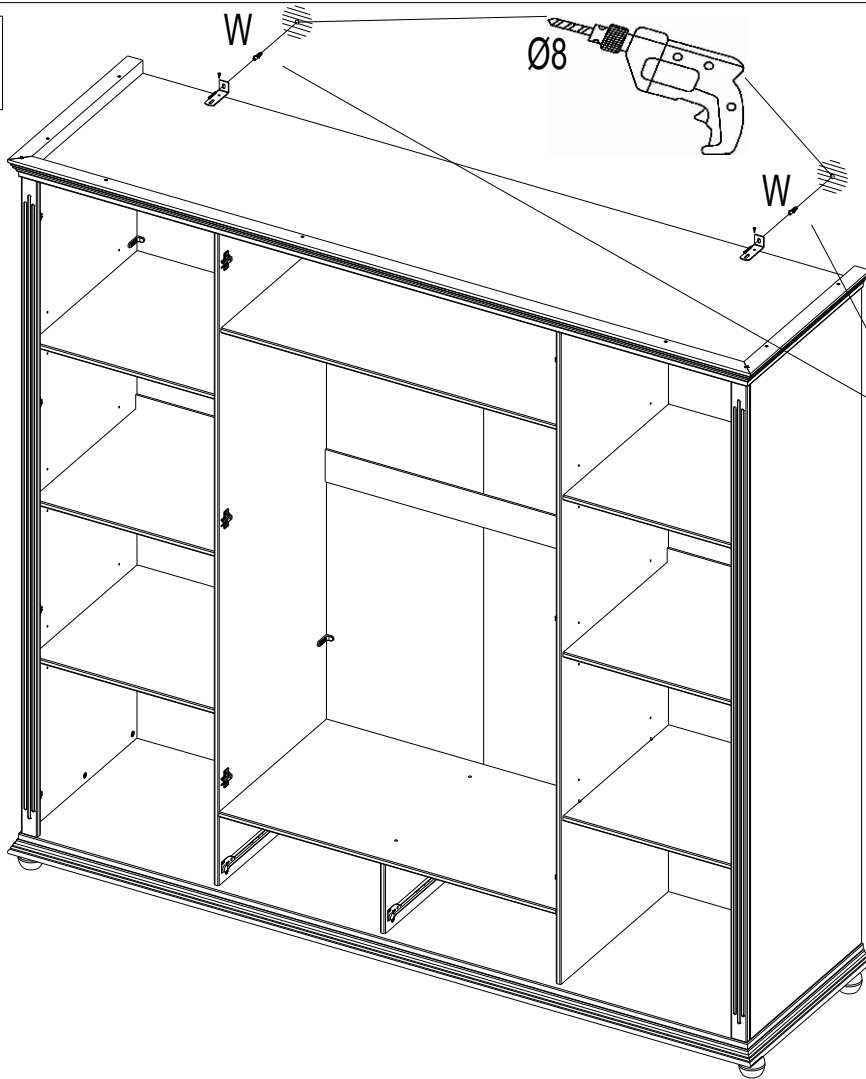

Q 3.5x15 x2

W Ø8x50 x2

X 5x50 x2

Y x2

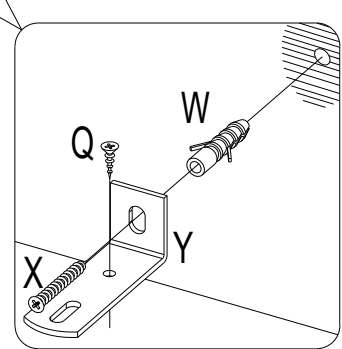

14

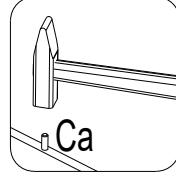
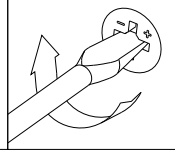
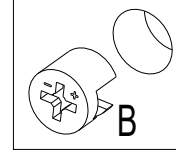
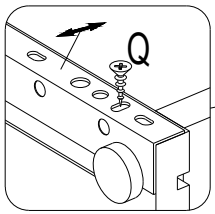
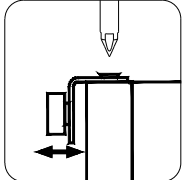
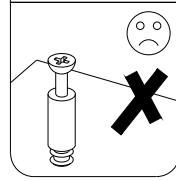
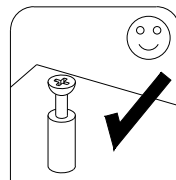
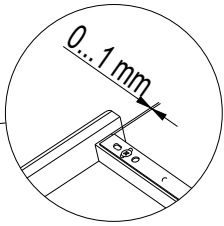
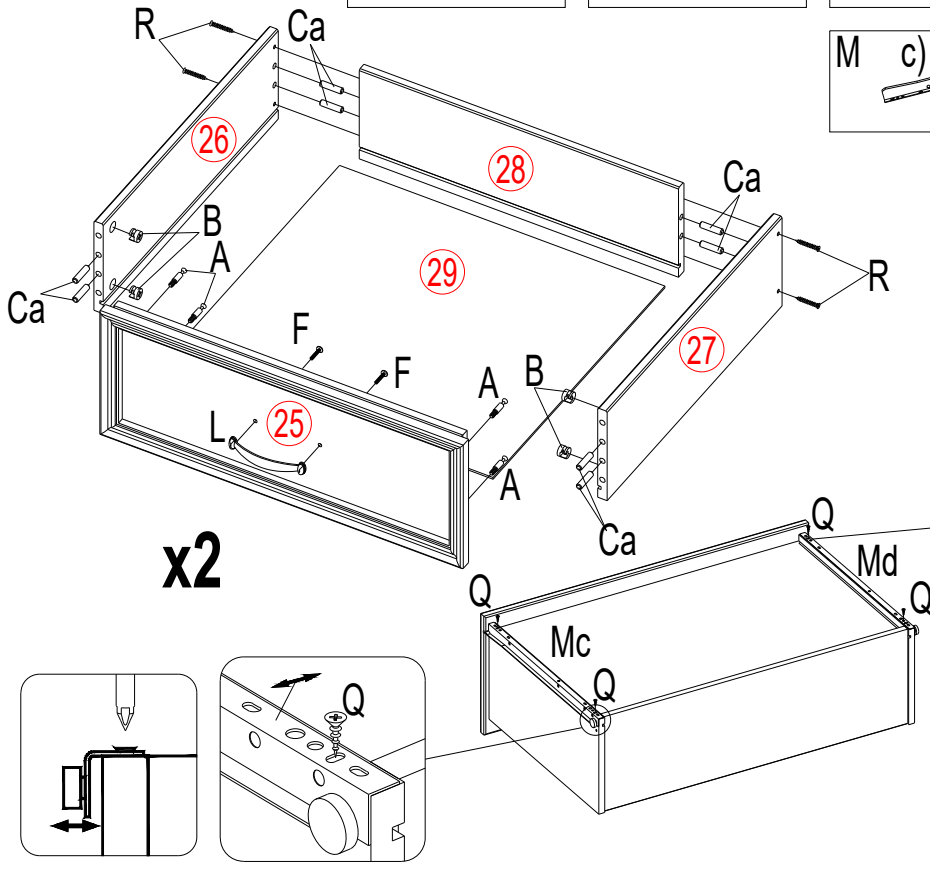
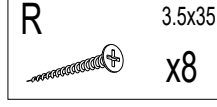
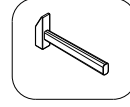
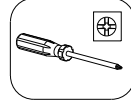
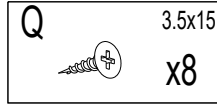
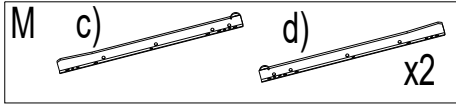
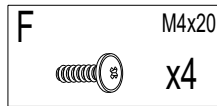
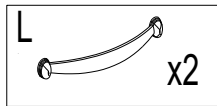
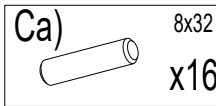
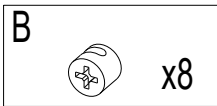
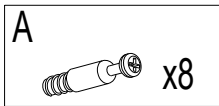

15

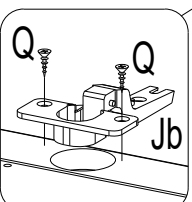
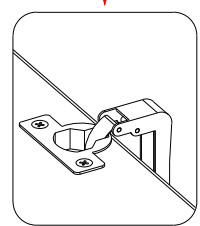
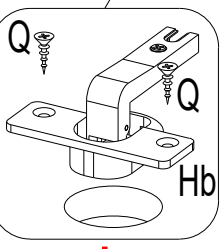
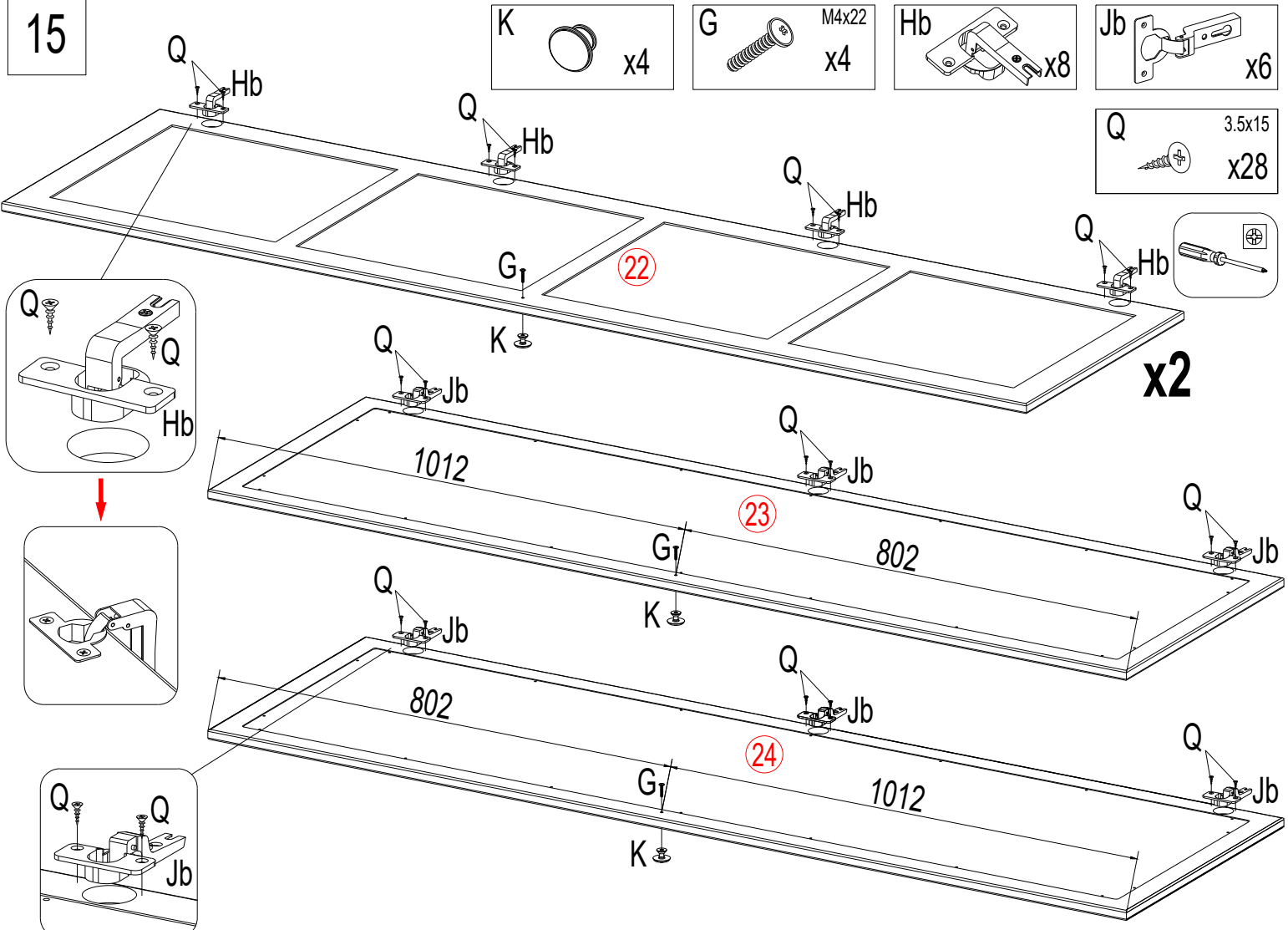
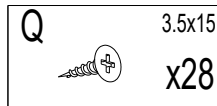
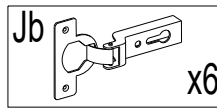
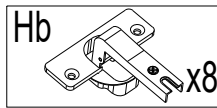
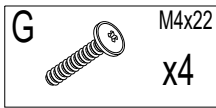

16

Zc) x2

